



Session 2b
Reass I

POSSIBLE NEEDS AND APPLICATIONS OF POLYPHASE RESONANT CONVERTERS

by

W. A. Reass, D. M. Baca, and R. F. Gribble
Los Alamos National Laboratory

Jan 2007

Contact Information:

William A. Reass; Phone: 505-665-1013, E-mail: wreass@lanl.gov

Abstract

High voltage polyphase resonant converters are a relatively new technology that can generate 100's of kV from a low voltage input source (few kV). The technology is fault tolerant and a shorted load will not harm the load or the converter. Fault energies are typically less than 10 joules. With multi-phase converters (>3) a lost or failed phase does not inhibit system operation. In addition, for very high power systems, converter modules can be added (e.g. 10 each 10 MW converters for 100 MW) as needed depending on the system load demands. This talk will review the research and applications to date that have been performed by Los Alamos National Laboratory.

Outline

- Review of Polyphase Resonant Power Conditioning Technology
- Design Possibilities of Large “MW” Class Converter-Modulators
- Smaller, Higher Frequency MOSFET Converter-Modulators
- Conclusion

What is Polyphase Resonant Power Conditioning?

- New method to generate high voltages from low with very high power
- Essentially a large (polyphase and resonant) DC-DC Converter
 - At least 1/10 size, weight, and volume of any previous method
- Uses recently proven technologies
 - Traction Motor Metallized Hazy Polypropylene Self-Clearing Capacitors for energy storage
 - Multi-megawatt capable Insulated Gate Bipolar Transistors
- Transformer cores of Amorphous Nanocrystalline Alloy
 - 1,000 times more efficient than steel
 - 1/300 core volume and weight for same power as 60Hz steel
- Polyphase resonant voltage multiplication to further minimize transformer volume and weight
- Easily scaleable to 10's of MW and 100's of kV
 - Easily optimized for various use (and lower power/voltage)
- Design is fault tolerant and inherently self-protective
 - Protect systems not necessary
 - Permits long cable lengths and remote location

Polyphase Resonant Power Conditioning Uses LANL/LANL Funded Technology Developments

- **Low Inductance Self-Healing Capacitors**
 - Thomson Passive Components (AVX), France
- **Low Inductance High Power Capacitors**
 - General Atomics Energy Products, San Diego, Ca.
- **Amorphous Nanocrystalline Core Material**
 - MK Magnetics (Stangenes), Adelanto, Ca.
- **New Engineering Techniques**
 - Polyphase Resonant Voltage Multiplication
 - Resonant Rectification
 - Self DeQing (No crowbars and self protective)
 - Snubberless IGBT Switching

Simplified Block Diagram of Polyphase Resonant Converter Modulator (10 MW Long Pulse)

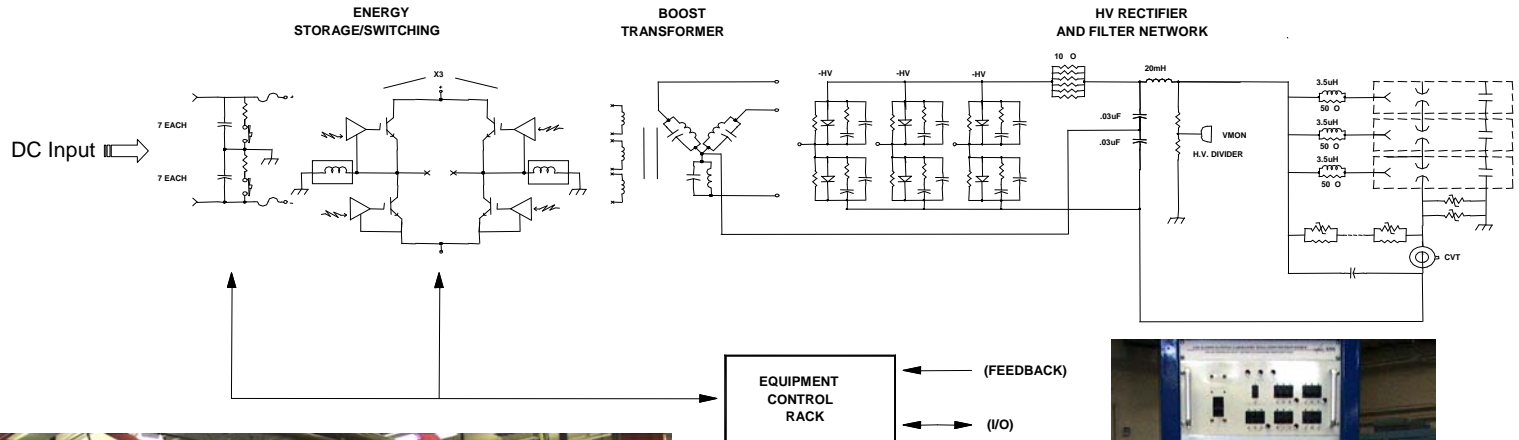

**HIGH VOLTAGE
CONVERTER MODULATOR**



**EQUIPMENT
CONTROL RACK**

Los Alamos High Frequency “Polyphase Resonant Power Conditioning” Compared To Conventional 60Hz Technology Is Significantly Smaller

10 Megawatt Pulse, 20 KHz, 140 kV
Polyphase Resonant Converter-Modulator



- Developed for Oak Ridge SNS Accelerator
- All components operate at 10 MW level
- Can be optimized for 10 MW CW
- Can be optimized for 30 MW Long Pulse
- Resonant conversion is fault tolerant
- Small and compact
- Reliable components
- Can operate with kilometer cable lengths
- No protection networks needed

Los Alamos Low Voltage Energy Storage Compared To Conventional High Voltage Method Is Very Compact And Reliable

Self-Healing Metallized Hazy Polypropylene



- 300,000 hour lifetime
- Graceful degradation
- High frequency design, variable rep-rate capabilities
- Extremely high volumetric efficiency
- High safety factor

Conventional High Voltage Paper and Foil Capacitors



- Limited lifetime
- Explosive failure modes
- Highly frequency dependant and lossy
- Large footprint
- Poor safety factors and dangerous
- Crow Bar required

Nanocrystalline High Frequency Transformers Are Over 150 Times Lighter And Significantly Smaller

Typical H.V. Transformer



- 100 kV, 60 Hz
- 20 Amp RMS
- 2 MW Average
- 35 Tons
- ~30 KW Loss

HVCM Transformer



- 140 kV, 20 KHz
- 20 Amp RMS
- 1 MW Average (3) present use
- 450 LBS for 3
- 3 KW Loss At 2 MW

Load Protection Networks Not Needed For Los Alamos Technology

Typical H.V. Crowbar Protect Network



- Large
- Reliability concerns
- Maintenance concerns

Resonant Converter Protect Network

This space left intentionally blank
(none required)

- Converter-Modulator inherently self protective
- Automatic fault “ride-through”
- Safe for all components

Tank Basket Assembly; 1 MW Average, 10 MW Long Pulse



Filter Network

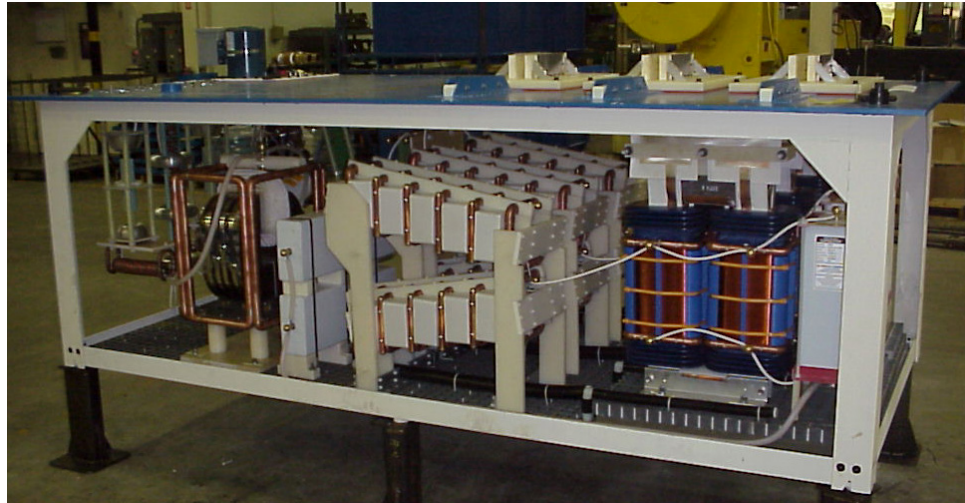

Tank Basket Assembly

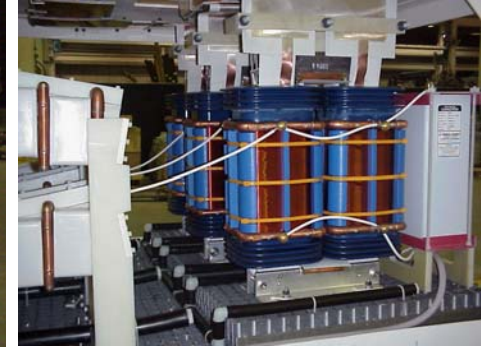

Transformers

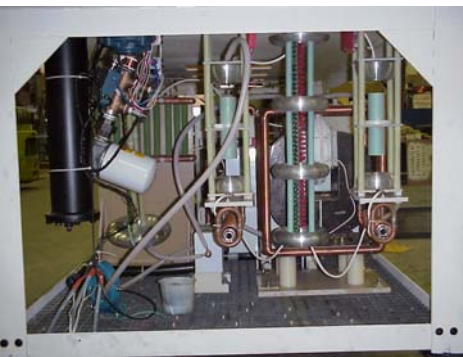

Output Sockets
&
Varistor Assembly



Oil Pump & Voltage Divider



Diode Rectifiers

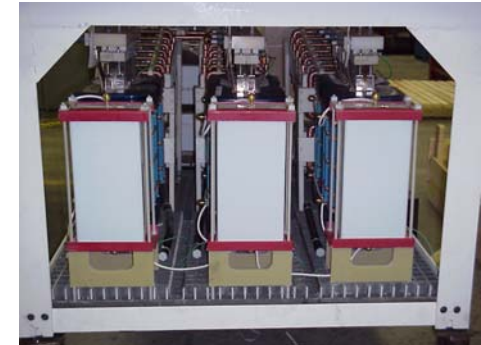

Transformer Resonating
Capacitors

IGBT Switch Plate Assembly; 1 MW Average, 10 MW Long Pulse

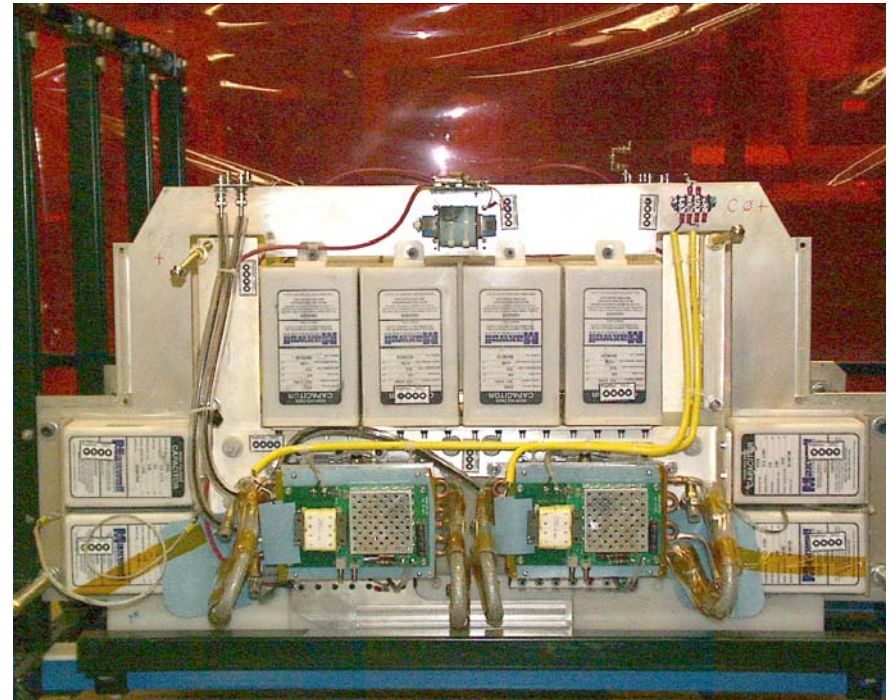
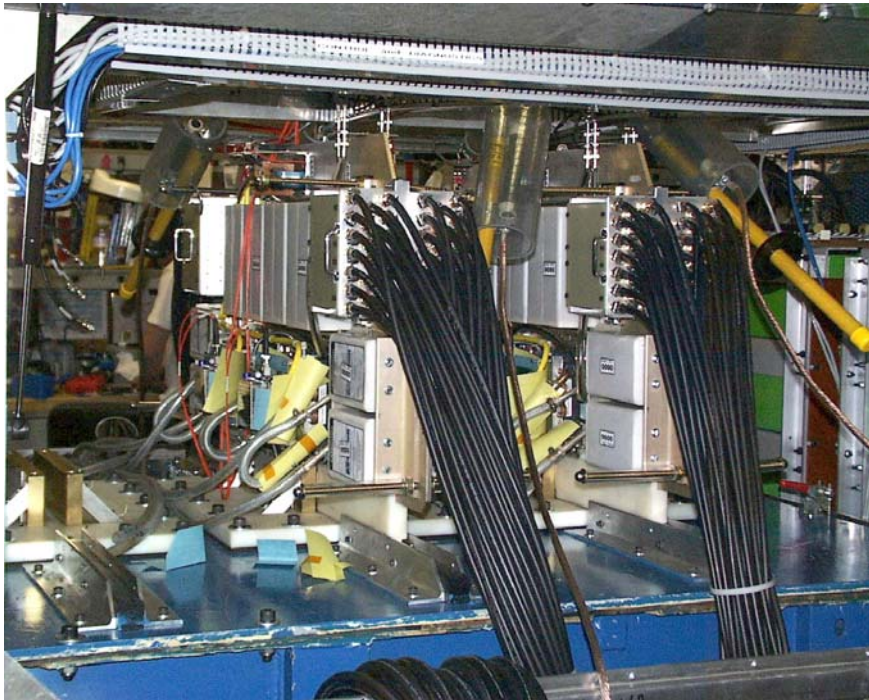

- Already operates at 10 MW switching level

Views of Installed Converters at Oak Ridge



DTL-ME3 with Klystrons
“The Workhorse”

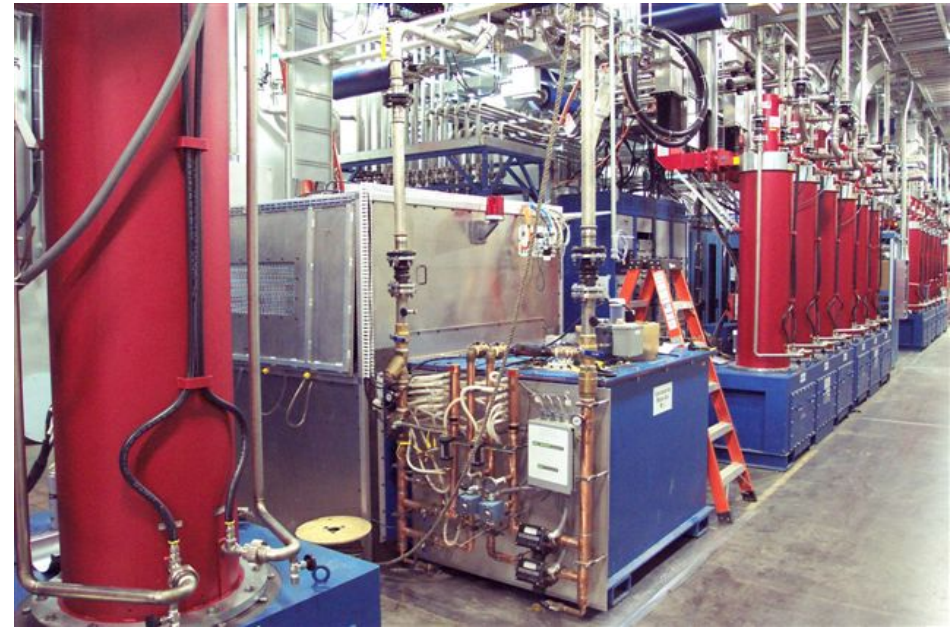

SCL-ME1 with 12 pack

125 kV, 10 MW Pulse for 402 MHz Klystrons

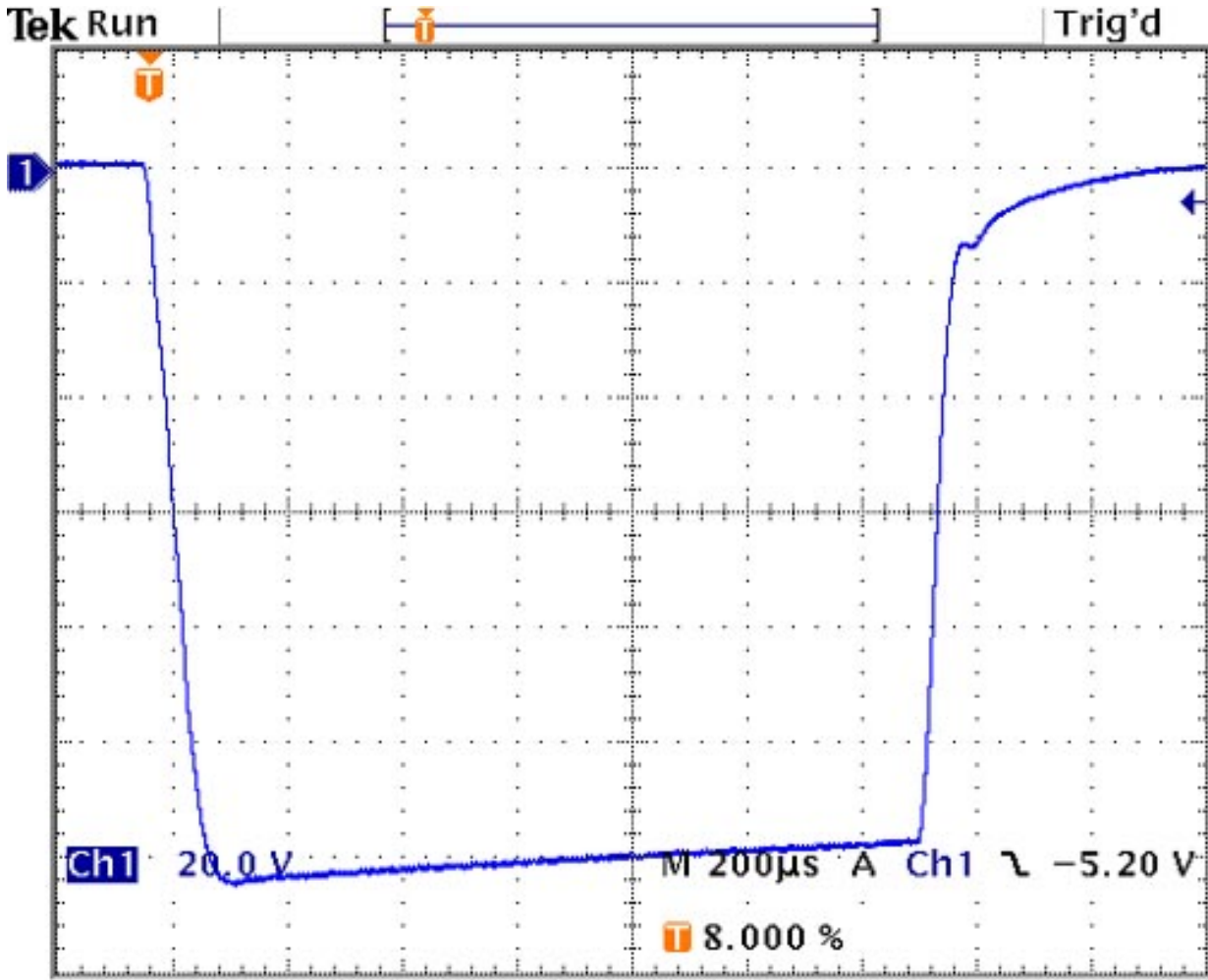

12 Klystron, 75 kV Operation (9.25 MW)

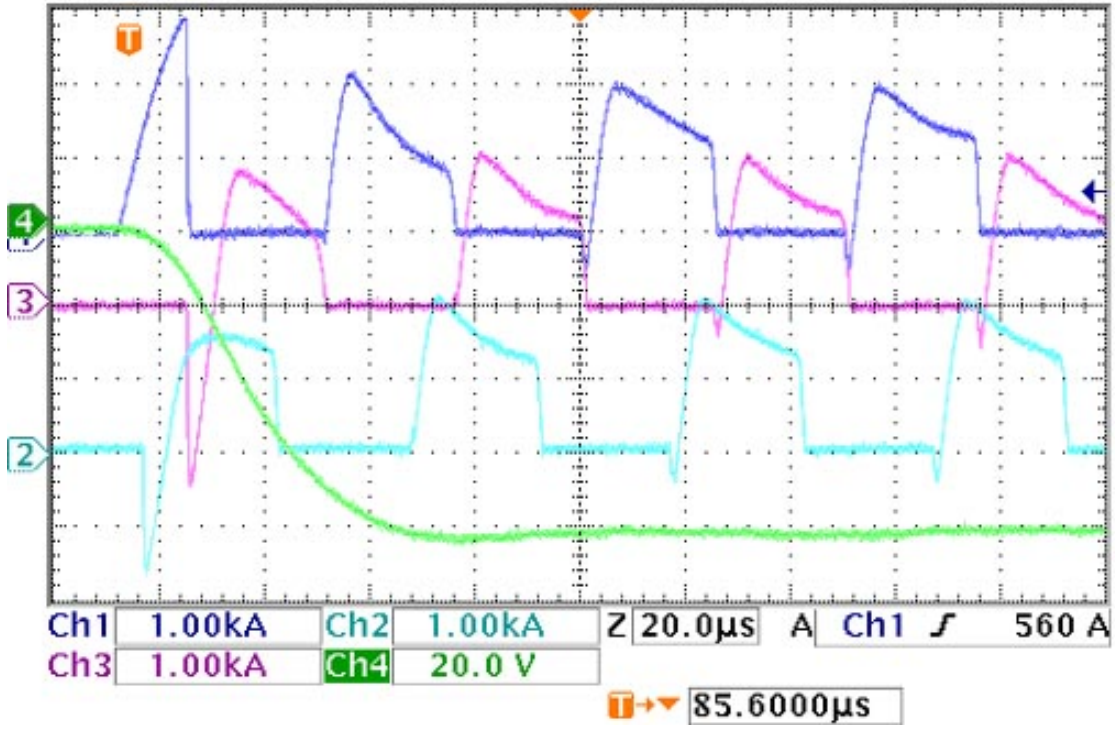
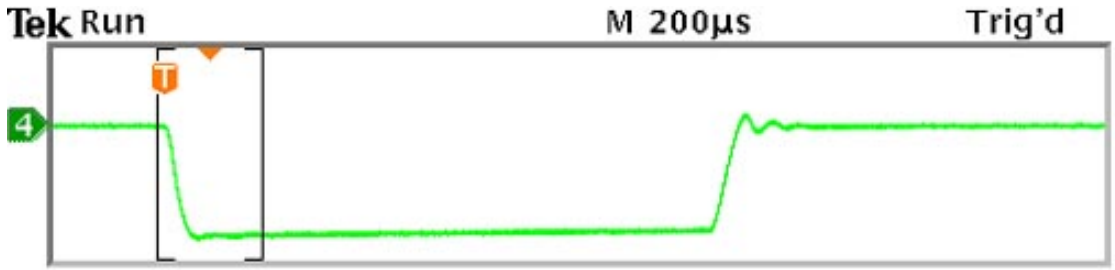

Output Voltage (~75 kV)

IGBT Switch Current (1 kA/Div)

20 Jan 2004
10:57:33

Capabilities of Polyphase Resonant Conditioning

- IGBT Long pulse systems demonstrated
 - 140 kV, 1 MW Average (10 MW Long-Pulse)
 - Efficiency ~94%
- IGBT CW systems to 10 MW realizable
 - Efficiency ~97% possible
 - Similar footprint to SNS system
 - Does not require increase in component current or voltage ratings
- Medium pulse MOSFET (10 – 100 μ S) to 2.5 MW, 250 KW Average
 - 50 kV, 50 Amp, 250 KW Average
 - Small and compact
 - Agile in voltage, pulse width, and rep-rate
- Semiconductors Still Limiting Technology at These Power Levels

View Of a Proposed 30 MW Pentaphase Converter-Modulator System (Pulsed)

Size: 7' X 8' X 14'

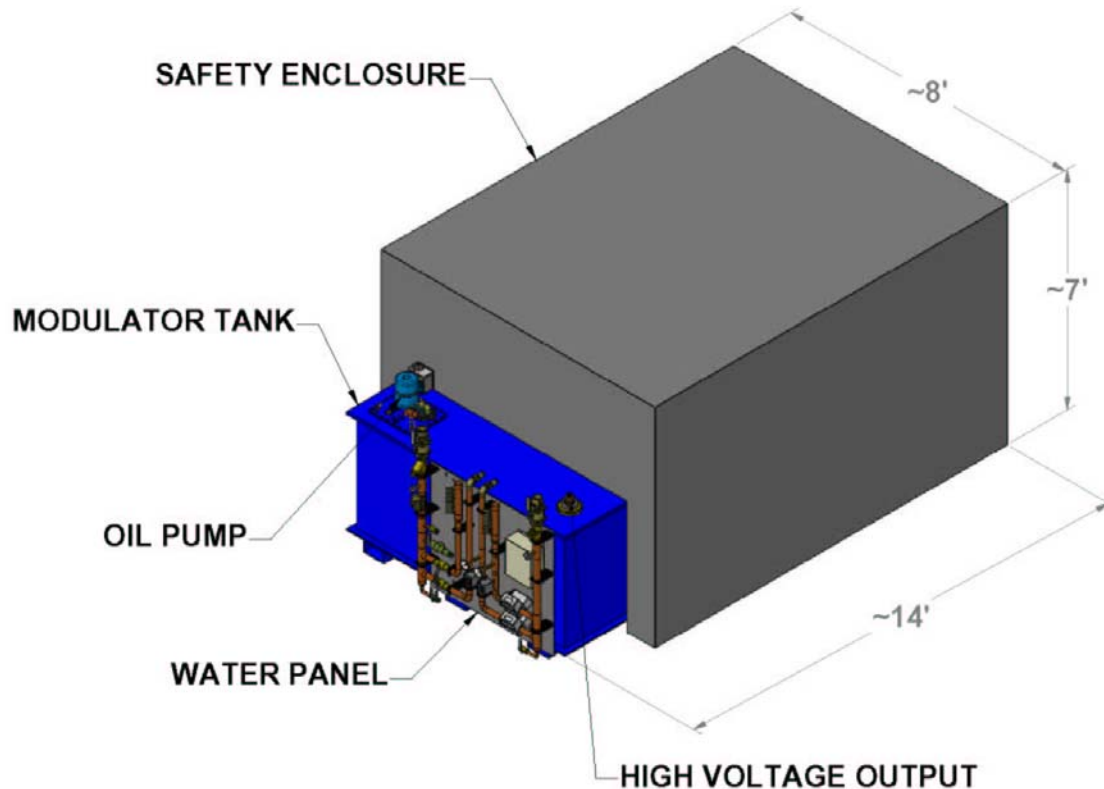

- Fault tolerant, automatic fault “ride-through”
- Can operate with long output cables (over 1 kilometer)
- Cannot harm load or self
- Multiple units operate from common DC bus
- Different Optimization for CW
- Present Designs Limited by Switching Devices

500 kV Converter Rise Time Detail

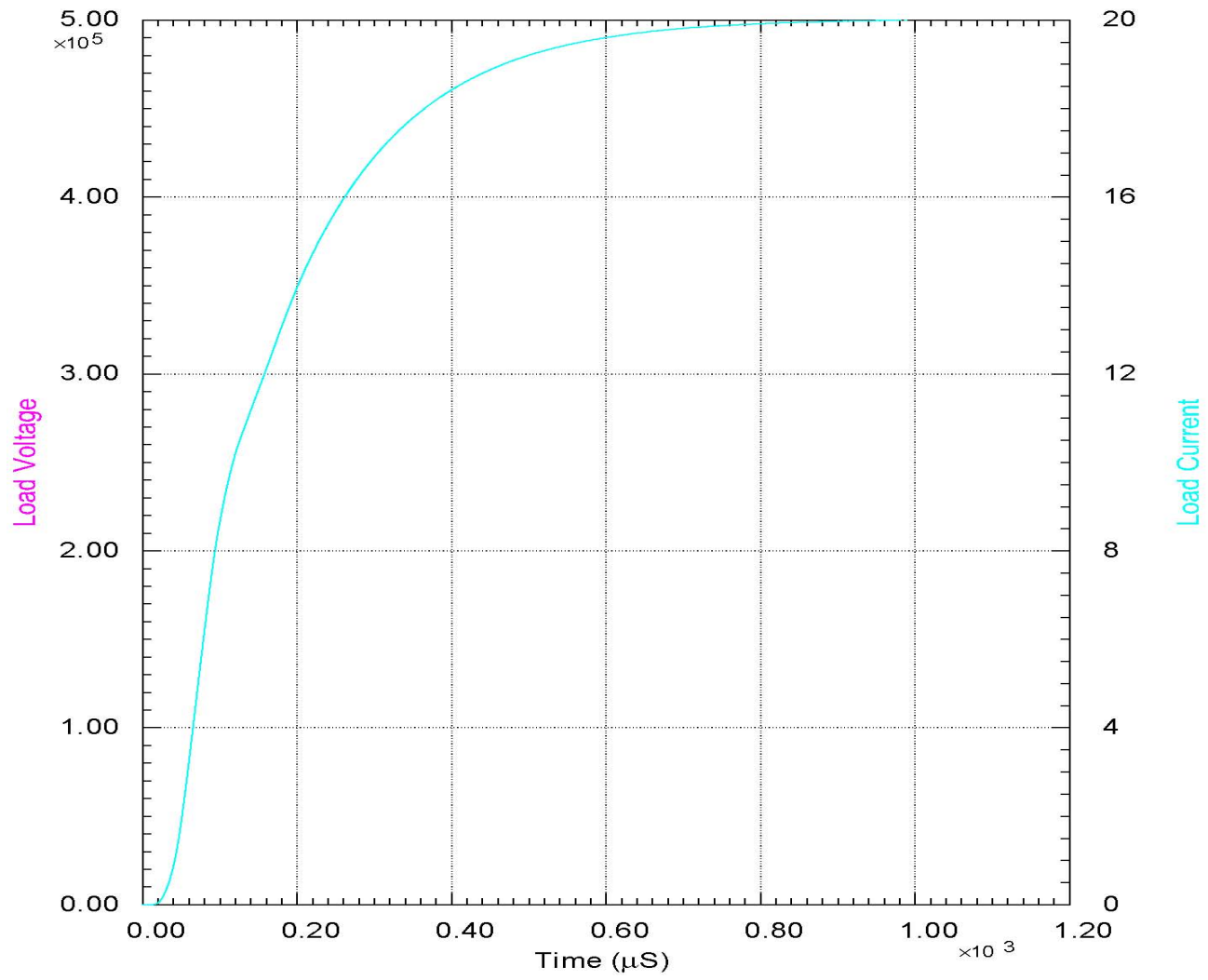

Klystron Fault Energy – 1KM Of Cable (125 kV)

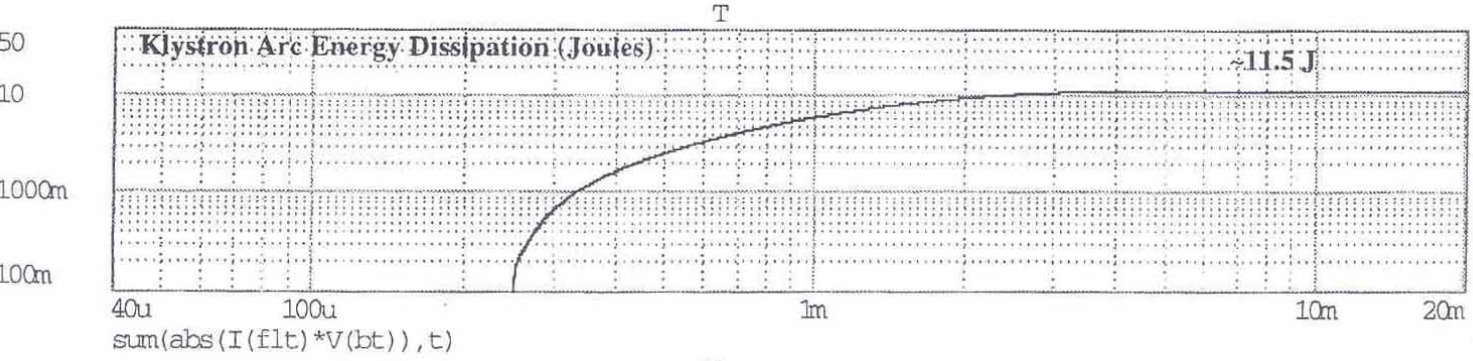
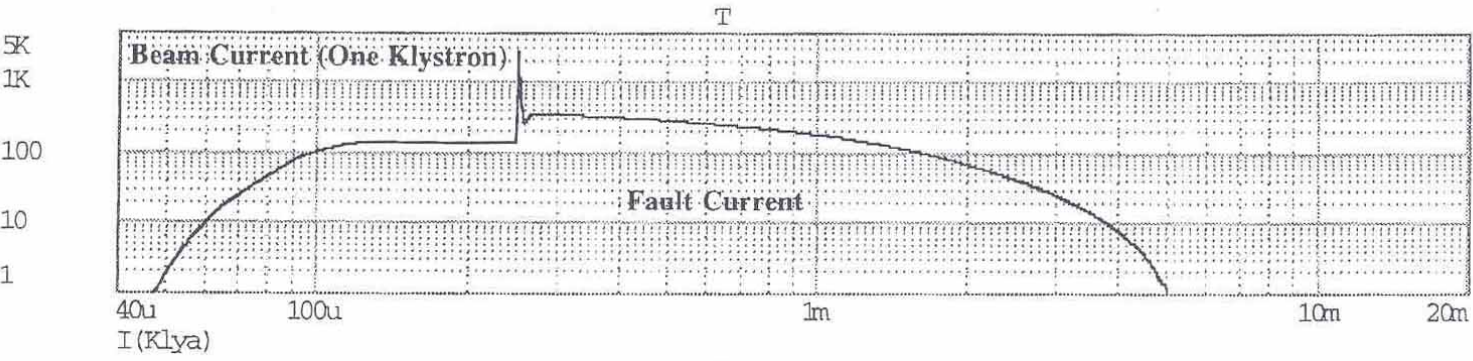
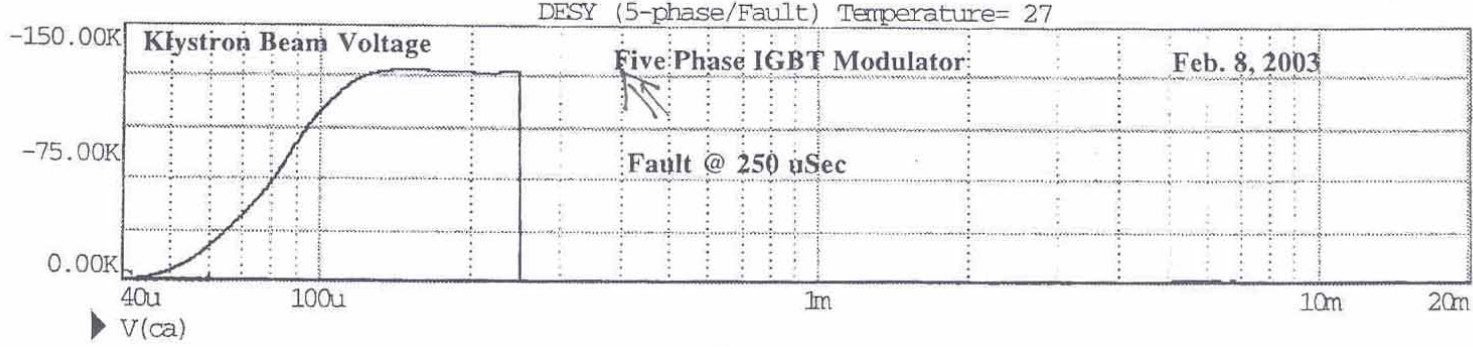

Novel Adaptive Feedforward/Feedback For Converter Control

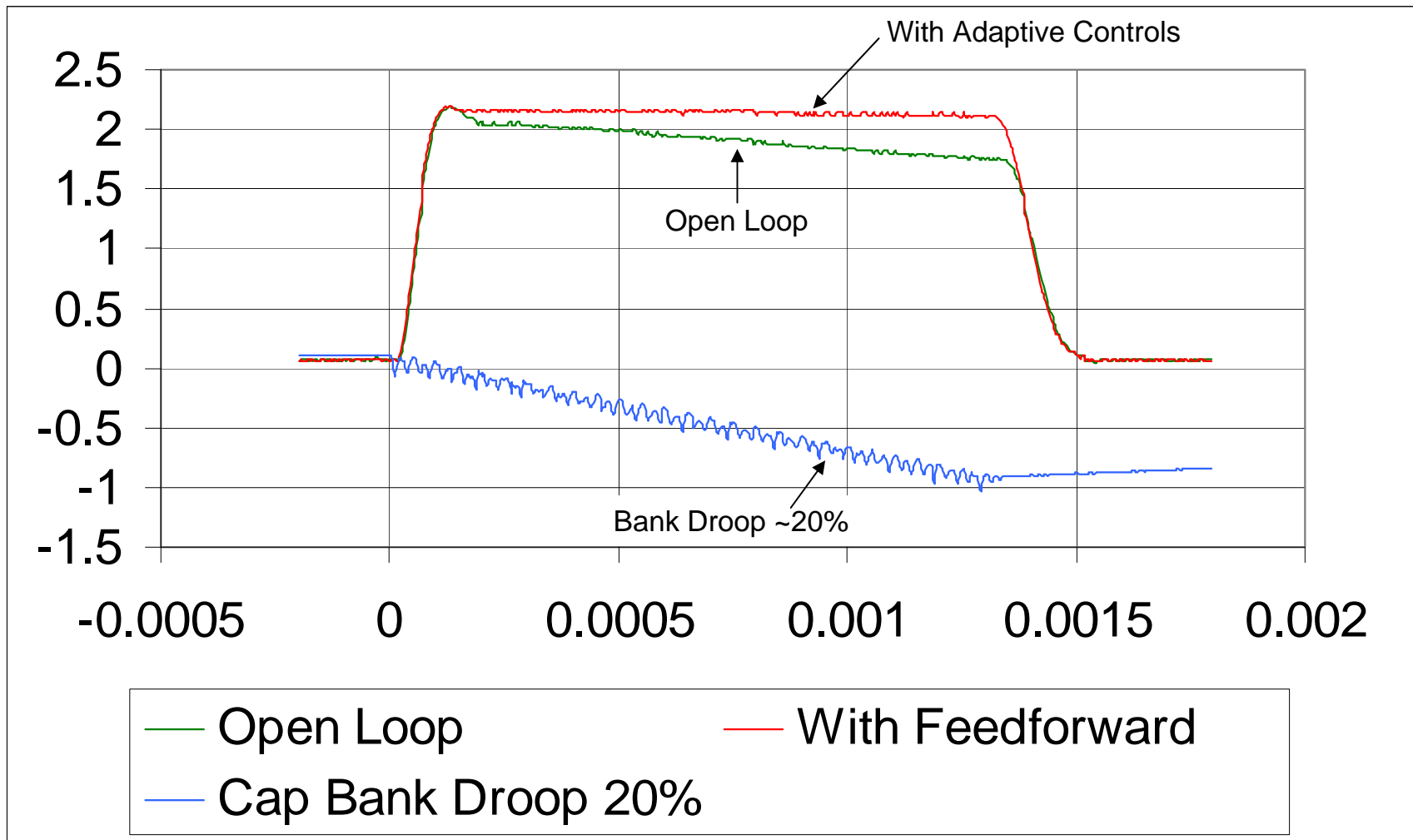

View of 2.5 MW Pulse, 250 KW Average, MOSFET Converter-Modulator

Size: 2.5' X 2' X 3'

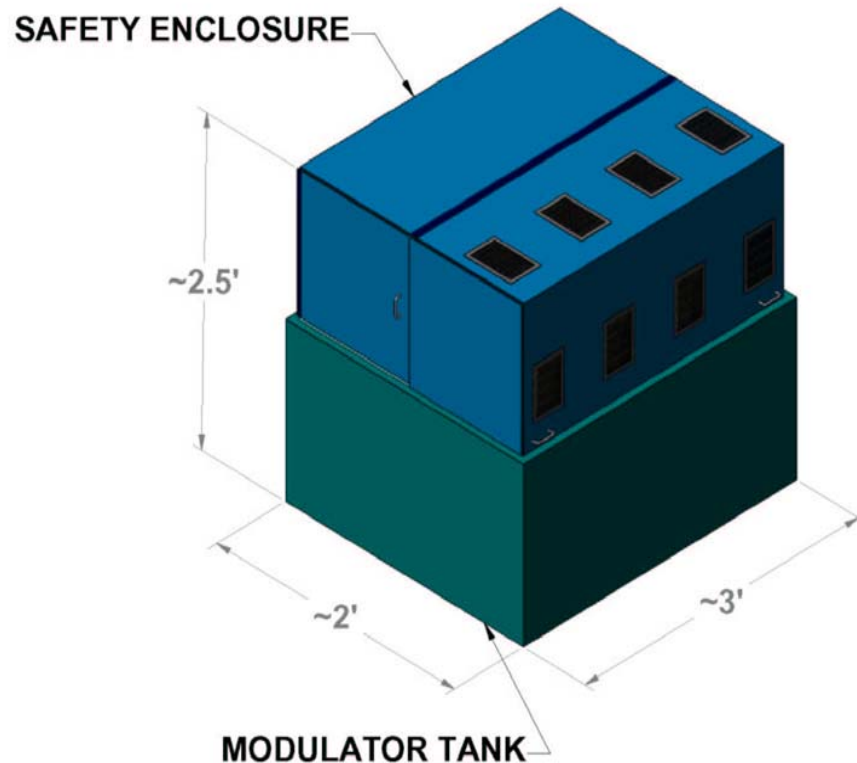

- Design Based On Available Components And MOSFET Switches
- Higher Frequency And Smaller
- Can Be Optimized For Mobile/Airborne Applications
- Typical Uses May Be Search Radar, DE, And Medical Applications
- Pulse Width/Rep-rate/Voltage Agile
- “CW” Designs Also Possible

Model Output Of Medium Pulse Converter

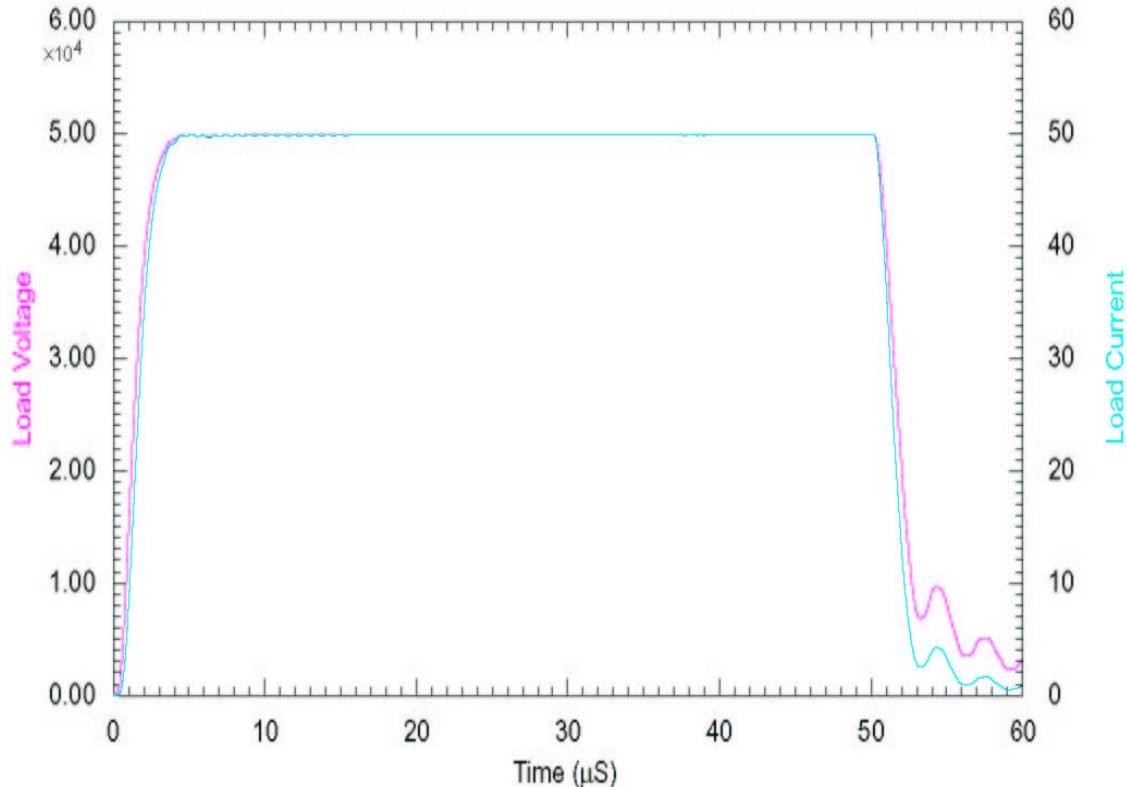

- Rectified 480V 3 \emptyset Input
- 50 kV Output
- 50 Amp Output
- Tr, Tf \sim 800nS
- \sim 94% Efficiency
- Other Optimizations Possible
- Pulse Width And Voltage Agile
- Multi KHz Rep-Rate

Soft Failure Mechanism 12 Pulse / 10 Pulse

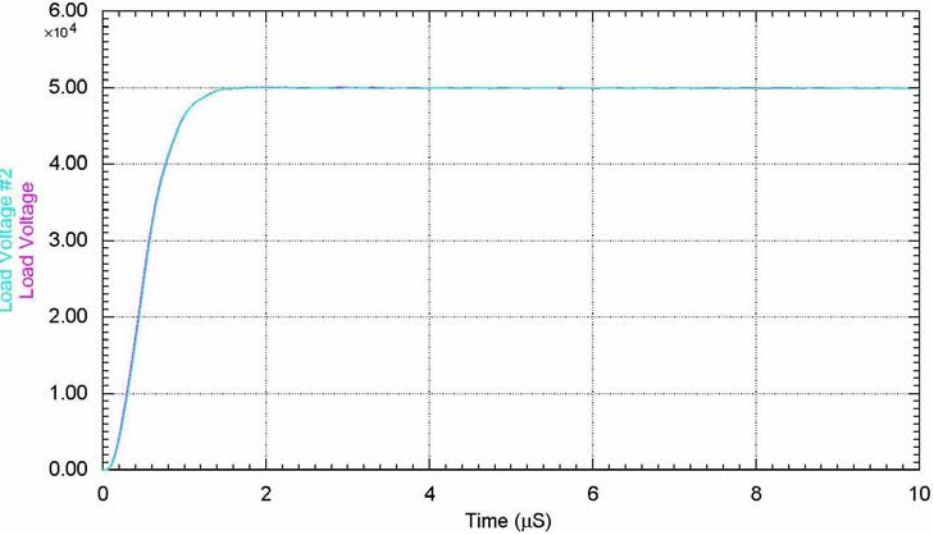

10 & 12 Pulse Output Voltages “Overlay”
(2 failed switching assemblies)

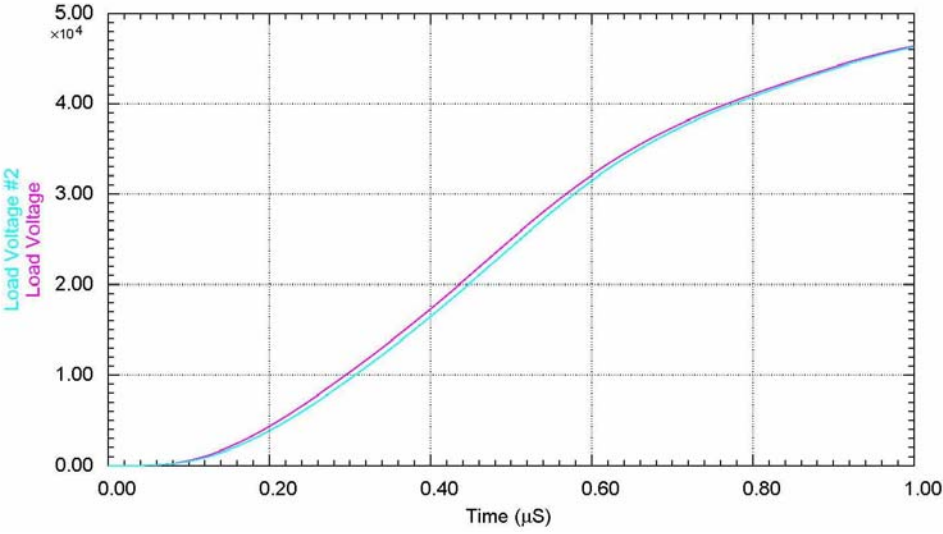

Slight Change In Rise Time For
10 Pulse vs. 12 Pulse Operation
(no significant difference)

Possible Applications Of Fault Tolerant Polyphase Resonant Converters

- Motor Drives
 - At Remote Locations
- Radar Modulators
- Power Distribution Networks
- Directed Energy, Area Denial Systems
- High Power Transducers/Drivers
- Electronic Pulse Generators
- Power Converters/Chargers For Pulse Power Application

Conclusion

- Los Alamos Developed Polyphase Resonant Power Conditioning Design Topology Techniques Now Proven
- Semiconductors Limiting Elements in Present Designs
- Designs Can Be Optimized For Any Load Or Pulse Requirement
- Efficient Adaptive Feedback Control Methods Now Possible
- Inherently Self And Load Protective
- Significant Change In High Power, Power Conditioning Topology
- Ideal For Many Military, Medical, Broadcast, And Scientific Applications
- Systems Installed At LANL, ORNL, And SLAC

Contacts: William A. Reass Phone: 505-665-1013 E-mail: wreass@lanl.gov
David M. Baca Phone: 505-665-8355 E-mail: dbaca@lanl.gov