

# Varistor versus Environment: Winning the Rematch

**François Martzloff**, Life Fellow, IEEE  
National Institute of Standards and Technology  
Gaithersburg MD 20899 USA  
[f.martzloff@ieee.org](mailto:f.martzloff@ieee.org)

© 1986 IEEE

Reprinted, with permission, from *IEEE Transactions on Power Systems*, Vol.PWRD No.3, April 1986

## **Significance:**

This paper is listed under four categories of the Annotated Bibliography as it bears on the corresponding topics. The multiple listing reflects the sections in which this paper is cited as supporting material for IEEE Std C62.41.1 and C62.41.2. Therefore, it can be found in the following four parts of the Anthology:

### **Part 2** Development of standard – Reality checks

Provides an example of the need to recognize capacitor switching transients when characterizing the surge environment

### **Part 3** Recorded occurrences, surveys and staged tests

Provides an example of monitoring and staged tests motivated by field failure, leading to a better understanding of the environment in which SPDs were expected to perform.

### **Part 4** Propagation and coupling of surges

Provides an example of how far (3000 meters) the low-frequency transients generated by capacitor switching can propagate, unabated, in a path involving two step-down transformers.

### **Part 7** Mitigation techniques

Provides an example of improved mitigation design based on field experience

# VARISTOR VERSUS ENVIRONMENT: WINNING THE REMATCH

François D. Martzloff, Fellow IEEE  
Corporate Research and Development  
General Electric Company  
Schenectady, New York 12345

**Abstract** — An unusual case of difficult application of surge protective devices was solved by field measurements with retrofit of protective devices suitable for the particular environment. On-site measurements indicated that capacitor switching transients were causing excessive current surges in the varistors and fuses protecting the input to a thyristor motor drive. Knowledge of the environment gained by the measurements allowed understanding of the problem and specification of matching surge protective devices.

## SUMMARY

During the initial startup of a solid-state motor drive in a chemical processing plant, difficulties arose with the varistor and its protective fuse at the input of the thyristor circuits. Frequent blowing of the fuse was observed, with occasional failure of the varistor. On-site measurements of the voltages and currents at the input to the drive indicated that switching transients associated with the operation of a remote substation capacitor bank and the relatively low clamping level of the varistor were producing current above the fuse and varistor ratings; hence the short lives of these two components. When the actual conditions at that site were determined by measurements, it became possible to specify surge protective devices capable of withstanding that environment. Immediate relief was secured by the installation of a larger varistor at the same point of the circuit; long-term protection was obtained by the addition of a gapless metal-oxide varistor arrester on the primary side of the step-down transformer feeding the drive. The situation has been changed from failures occurring every few days to no further problems in the 3 years since the larger varistor was installed.

## INTRODUCTION

This paper presents a case history illustrating how surge protective devices that are successfully applied for the majority of cases can occasionally suffer failure when exposed to exceptionally severe surge environments. This paper also shows how little attenuation occurs, at the frequencies produced by switching surges, between the distribution level (23 kV) and the utilization level (460 V), even though a long line and two step-down transformers exist between the source of the transient and the point of measurement.

85 SM 365-2 A paper recommended and approved by the IEEE Surge Protective Devices Committee of the IEEE Power Engineering Society for presentation at the IEEE/PES 1985 Summer Meeting, Vancouver, B.C., Canada, July 14 - 19, 1985. Manuscript submitted February 1, 1985; made available for printing April 22, 1985.

The problem involved a 460 V power supply to a thyristor drive circuit in a chemical processing plant extending over several square miles. During the initial startup, difficulties arose with the varistor and its protective fuse at the input of the thyristor circuits. Frequent blowing of the fuse was observed, with occasional failure of the varistor. The plant substation, fed at 23 kV from the local utility, included a large capacitor bank with one-third of the bank switched on and off to provide power factor and system voltage regulation. These frequent switching operations were suspected of generating high-energy transients that might be the cause of the failure of the fuses and varistors, because literally thousands of similar drive systems have been installed in other locations without this difficulty. On-site measurements performed after repeated blowing of fuses and occasional failure of varistors connected at the input to the thyristor drive indicated that indeed the devices were not matched to their environment. From this point on, specifying larger sizes, sizes appropriate to the environment [1], solved the problem.

## POWER SYSTEM AND SWITCHING TRANSIENTS

Figure 1 is a simplified one-line diagram of the significant elements of the power system causing the varistor failures. The incoming 115 kV power is stepped down to 23 kV. Three banks of 5400 kVAR capacitors are connected to the 23 kV bus. Typical operating conditions involve two banks connected at all times, with the third bank switched on or off automatically to provide voltage regulation. Power distribution throughout the site is done at the 23 kV level.

The various drive systems which experienced the difficulty are supplied at 460 V by a 2300/460 V transformer in their control house. A substation close to the control system supplies the 2300 V power from the 23 kV distribution system.

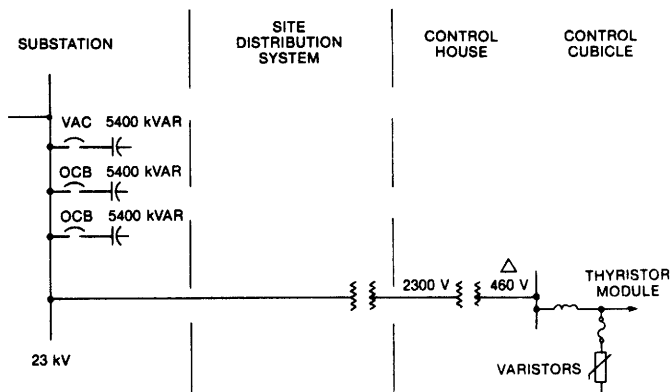

Figure 1. Simplified one-line diagram

Figure 2 is a simplified three-phase schematic of the power input. In the original circuit, the thyristor modules were protected by varistors at the power input of the 1250 hp drive, where the measurements were made. A  $6 \mu\text{H}$  line inductance,  $L_1$ , was inserted between the bus and the thyristor modules; 20 mm varistors rated 510 V were connected in a delta configuration, in series with a current-limiting fuse in each line. The varistor connection was about 80 cm long, introducing an estimated  $1 \mu\text{H}$  inductance into each lead.

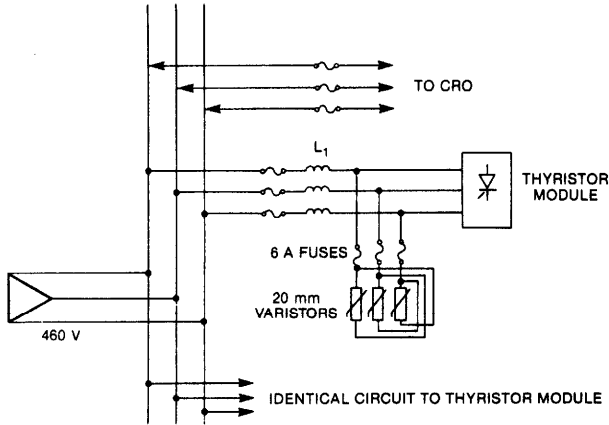

Figure 2. Simplified three-phase schematic

### Instrumentation and Measurements

Oscilloscopes were used to measure voltage across one varistor and its connection and currents through all varistors. Voltage measurements were made phase-to-phase on the floating delta 460 V bus bars with Tektronix P6015 1000:1 probes, connected to a Tektronix 7633 storage oscilloscope in differential mode. Current measurements were made with a Tektronix CT5 20:1 current transformer coupled with a P6021 current probe and connected to a second Tektronix 7633 storage oscilloscope.

The trigger modes used during a two-hour monitoring period included positive or negative slopes for both slow ac and high-frequency modes. For the various modes, the level was adjusted to produce a trigger for a voltage exceeding the normal line voltage crest by about 20%, or a varistor current in excess of 2 A. No trigger occurred during the monitoring period. A low-frequency voltage recorder installed by plant personnel produced a recording characterized as representative of an unusually quiet day in the power system operations.

Manual off-on switching of the 5400 kVAR capacitor bank at the 23 kV utility substation was the next step in the measurement procedures because the switching of a capacitor bank is always a prime suspect for producing transients. Measurements were performed with one oscilloscope monitoring the line voltage upstream of the line inductors (Figure 2) and another oscilloscope monitoring the sum of the currents in the three varistors (Figure 3).

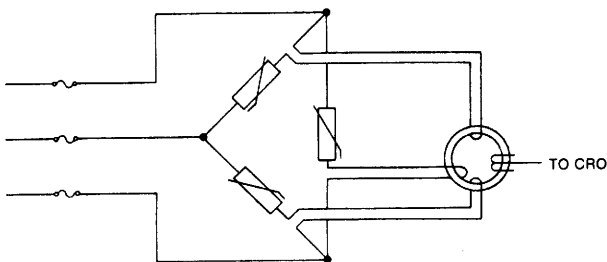

Figure 3. CT connection for recording all three varistor currents

### Results

The oscillograms of Figure 4 show typical voltage recordings made during this sequence. The voltages are *not* open-circuit transient voltages. They are instances of the voltage appearing at the bus entrance point. This voltage is the sum of the varistor clamping voltage, the voltage drop in the varistor connections, and the voltage across two  $L_1$  inductances.

A typical total event recorded on one of the phases during a capacitor bank closing is shown in Figure 4A. A low-frequency oscillation with a period of 3 ms (330 Hz) and initial peak-to-peak amplitude of 450 V decayed in about 10 ms. The high-frequency oscillations are resolved in the recording of Figure 4B (recorded during a similar switching sequence). This high frequency was an initial peak-to-peak amplitude of 2000 V, decaying in about 5 ms. The period is  $180 \mu\text{s}$  (5.5 kHz). A similar, third event is shown in Figure 4C. For scaling the amplitudes, the steady-state voltage is shown in Figure 4D.

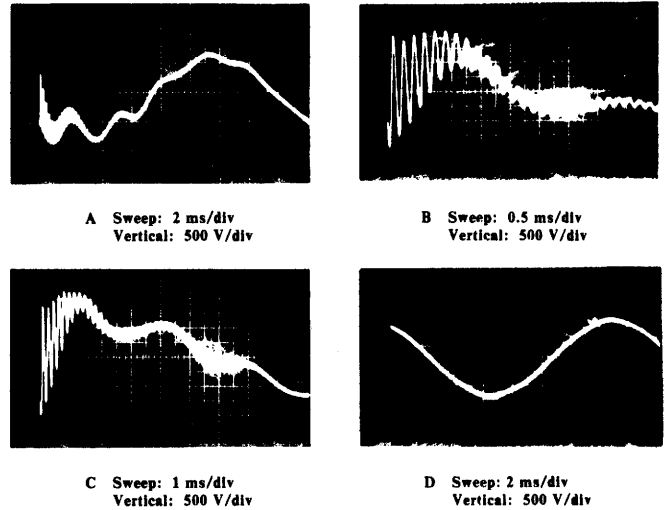

Figure 4. Capacitor switching transients and steady-state voltage

Observe that, depending on the time of closing with respect to the 60 Hz voltage, the 5.5 kHz oscillation varies in amplitude; furthermore, the modulation by the 330 Hz oscillation pushes crests of the 5.5 kHz oscillation above the 1000 V level some time after the beginning of the trace, at a time when the 5.5 kHz amplitude is already lower, producing a burst of pulses above the 1000 V level.

The significance of this finding will be discussed next, with reference to Figure 5, which shows recordings of transient currents in all of the three varistors. The 510 V varistor has a nominal voltage at 1 mA [2] in the range of 735 V to 970 V. For a varistor with a nominal voltage in the middle of this range, a current in the order of tens to hundreds of amperes will flow if a voltage of 1000 V is applied to the varistor. Figure 5A shows a train of current pulses in the range of 10 to 40 A. In the burst of Figure 5B, the recorded current pulses range from 5 A to 200 A. The current and voltage traces are not simultaneous events because each of the two oscilloscopes was triggered by its internal circuit. The nearly symmetrical appearance of this burst can be compared to the symmetry of the voltage peaks exceeding the 1000 V level in Figure 4, the one correlating with the other.

The oscillograms of Figures 4 and 5 were selected as most severe from a series of 20 capacitor switching sequences. Some sequences could not even produce a current or voltage trigger; four sequences produced bursts with the central peak exceeding 120 A, two of these reaching 200 A peaks.

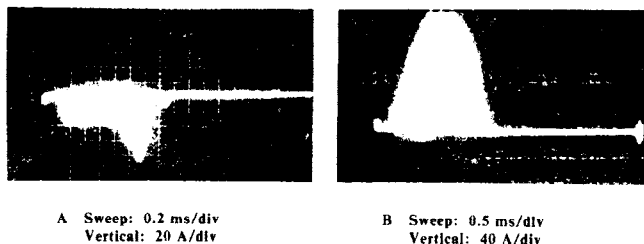
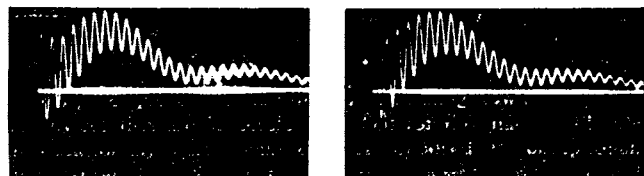

Figure 5. Current surge bursts during capacitor switching

These recordings establish the nature of the current surges that are conducted by the varistors, with an estimate of 10% reaching 200 A maximum crests and another 10% reaching 120 A crests, for all capacitor bank switching.

In Figures 4 and 5, we note that the characteristic appearance of the voltage and current usually observed during a switch restrike is absent [3], indicating a clean switching action of the vacuum interrupters used for switching the capacitor bank. Restrikes are most likely to occur during de-energizing. In all the off-on switching sequences of this test series, no significant transient was observed during de-energizing; all occurred during energizing.

The oscillograms of Figures 4 and 5 establish and explain the pattern of current pulses. The voltages of Figure 4 are not the open-circuit voltages impinging the drive input but, rather, the voltages resulting from the clamping action of the varistors. To better evaluate the magnitude of the switching transients, open-circuit voltages were recorded in a next sequence, with all fuses to the drive open, thus disconnecting both the varistors and all sensitive loads. Figure 6 shows two typical recordings of open-circuit voltages and two of voltages resulting from varistor clamping, recorded during a series of 10 switching sequences for each condition. Table 1 shows the recorded crests of the five highest voltages in each condition; the difference between the two groups, with due allowance for the imperfect statistical basis of the observations, indicates that the 510 V varistors reduced the peaks from a typical high of 1450 V to a typical high of 1100 V.



Open-Circuit Voltages

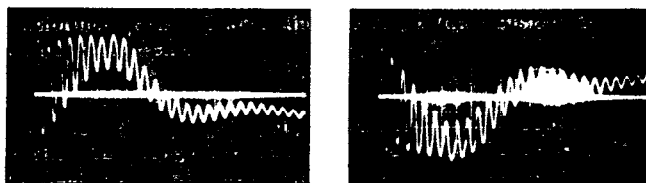

With 20 mm Varistors

All Traces: Sweep: 0.5 ms/div  
Vertical: 500 V/div

Figure 6. Capacitor switching transients

Table 1  
FIVE HIGHEST TRANSIENTS  
IN SEQUENCE OF 10 SWITCHINGS

Without Varistors	With Varistors
1450	1100
1400	1100
1300	1050
1300	1050
1300	1050

## DISCUSSION

### Nature of the Transients

The absence of any transient (over 120% of normal crest) during the 2-hour monitoring period was somewhat surprising, in the context of earlier reports of high counts recorded with Dranetz disturbance analyzers. Frequent checks of threshold levels and variations of the possible trigger modes were made, maximizing the chance of catching an overvoltage, but indeed none occurred. This unusual quiet was also reflected in the chart recording made by the plant personnel, so that the absence of random transients for that period can be accepted at face value.

Therefore, conclusive evidence was obtained that substantial current pulses were absorbed by the varistors during capacitor switching. The magnitude and duration of these pulses were excessive for the capability of a 20 mm disc; many similar drives installed elsewhere do not experience the failures encountered at that particular location.

Another significant finding from these measurements is the fact that the switching transients, generated at the 23 kV level, propagate down to the point of utilization at the 460 V level. Numerical discussion of this finding is given later in this paper.

### Effect of Transients on Varistors

Published varistor specifications include the "pulse ratings," a family of curves that define, for each varistor type, the number of isolated pulses that a varistor can absorb until its "rating" is reached [4]. The curves show lines relating amplitude, duration, and total number of pulses. Figure 7 shows this family of curves for the original 20 mm varistor.

Figure 8 shows the same curves for a proposed 32 mm varistor. It should be noted that the pulse rating does not mean catastrophic failure of the varistor at the end of this rating, but only a 10% change in the varistor nominal voltage. Although some change is indicated, the varistor is quite capable of staying on line voltage and of clamping surges.

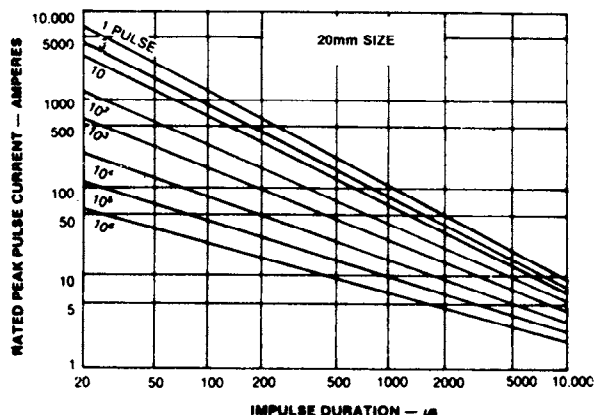

Figure 7. Pulse ratings of 20 mm varistor [4]

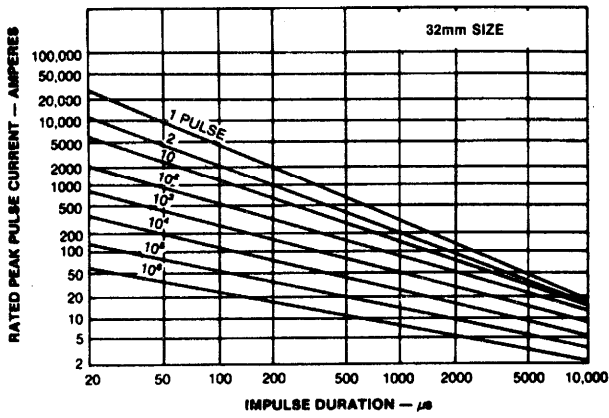
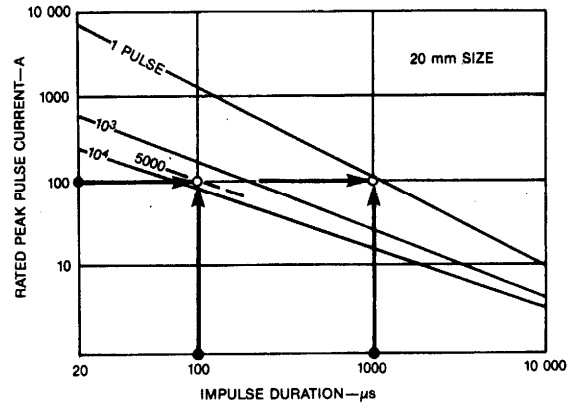

Figure 8. Pulse ratings of 32 mm varistor [5]

A careful examination of the pulse rating curves will show that the duration of the pulses has a strong influence on the number of permissible pulses. Furthermore, the relationship between the increased duration of the pulses and the decreased number of permissible pulses is not proportional. For instance, consider pulses of 100 A peak and 100  $\mu$ s duration (Figure 9A): the curves show 5000 pulses allowed. Now increase the duration of the pulses to 1000  $\mu$ s (a ten-fold increase), while keeping the amplitude at 100 A: the curves show the permissible number as one pulse only. Thus, the ten-fold increase in duration does not result in a ten-fold decrease in the number of permissible pulses; the reduction in that number is much greater than the inverse of the increase in duration. Conversely, taking a pulse duration of 1000  $\mu$ s, and seeking the amplitude allowable for the same 5000 pulses, Figure 9B shows that the current is 20 A, which is five times less than the original 100 A, not ten times less. Therefore, it would be incorrect to treat the multiple pulses of Figure 5 as five separate short pulses; rather, one equivalent long pulse has to be defined.

The five-pulse burst of Figure 5 has been redrawn in Figure 10 in order to plot an equivalent continuous pulse of approximately equal duration, with a crest such that the  $i \cdot t$  integral of the burst and the  $i \cdot t$  of the equivalent pulse are approximately the same. The use of  $i \cdot t$  rather than the  $i^2 \cdot t$  integral typically used for fuses or other linear loads is justified by the fact that heat deposited in the varistors is the significant parameter because the nominal voltage change process is temperature related; this heat is the product of the variable  $i$  and the nearly constant voltage across the nonlinear varistor during the burst.

The equivalent pulse of Figure 10 can then be used to evaluate, from the pulse ratings of Figure 7, the number of high-amplitude switching transients that will consume 100% of the varistor pulse rating. Inspection of Figure 6 shows that for a 800  $\mu$ s duration and 100 A amplitude, the pulse rating of the 20 mm varistor (6 kA rating at 8/20  $\mu$ s) is reached with two such events. With a probability of about 10% that this highest switching transient would occur during random timing of the switching (the effect decreases rapidly for transients other than the highest) and with 2 to 4 switching operations each day, the pulse rating of the varistors could be reached with 20 operations, failure perhaps starting at 40 to 50 operations, or after about 10 days of exposure to that power system environment. This estimate is unavoidably imprecise because the pulse rating curves represent a conservative minimum; actual failures will occur only for amplitudes or numbers of pulses exceeding the rating by a large but imprecise margin to allow for manufacturing variations. However, the order of magnitude of this estimated time to failure is in accord with the observations made at that installation.



A. Same current, increasing duration

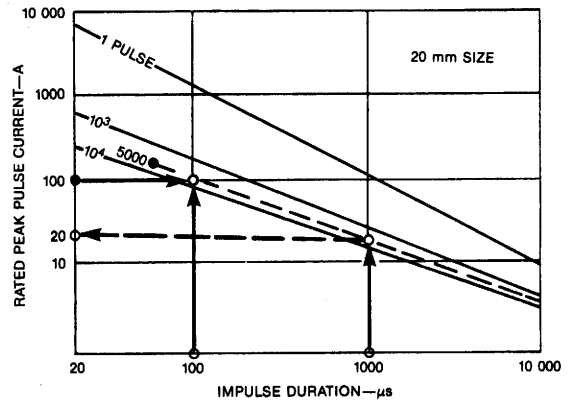

B. Same number of pulses, increasing duration

Figure 9. Reading pulse ratings curves

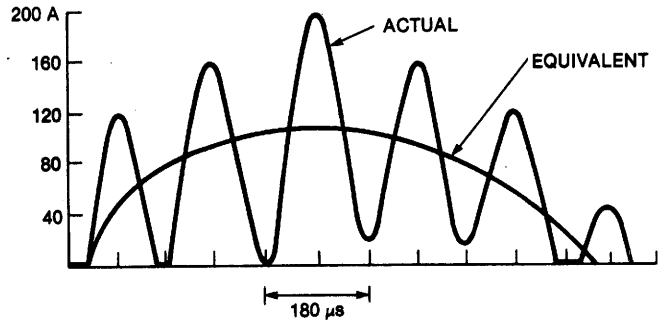

Figure 10. Single-pulse equivalent pulse for multiple pulses

Note that two types of events occur. One is the premature blowing of the fuse, which is not caused by a varistor failure but by the  $i^2 \cdot t$  capacity of the fuse being exceeded by the environment [1]. The other is the fuse blowing caused by the varistor end-of-life ultimate failure.

## Alternate Varistor Selection

An obvious remedy would be to use a varistor with greater energy-handling capability. The 32 mm size offers such a possibility. Inspection of Figures 7 and 8 shows that the equivalent pulse of Figure 10 (800  $\mu$ s and 100 A) corresponds to a permissible occurrence of 100 pulses for the 32 mm varistor, in contrast to the two for the 20 mm varistor. The improvement in the number of pulses is 50 times more pulses until *pulse rating* is reached. The improvement in the number of pulses until *varistor failure* occurs, however, is not necessarily 50 times more pulses. Because of the imprecision mentioned previously in the margin between end of pulse rating and ultimate failure, that margin is not necessarily the same for the two sizes, 20 mm and 32 mm, but it is reasonable to expect the same order of magnitude improvement in the ultimate failure as in the pulse rating. This expectation of a 50 times improvement would change the time between failures from the few days observed with the 20 mm size to perhaps one year with the 32 mm size, providing immediate relief and time to make further changes for the long term. Therefore, the change to a 32 mm size, connected at the same point of the circuit, was immediately implemented for that particular environment.

Further gains could be obtained in the length of time between varistor failures by increasing the clamping voltage of the varistors. This increase would result in lower current pulses for the same open-circuit transient voltage. A 510 V rating had been selected by the designer of the drive as the result of a trade-off between varistor clamping voltage and the withstand voltage of the thyristors protected by the varistors. If thyristors with higher voltage withstand were used, the solution would be easy.

Of course, the standard varistor product line has a certain tolerance band, reflecting normal production lot variations. In principle, a selection could be requested from the manufacturer that varistors with a narrower band be supplied for this application. The maximum clamping voltage allowed by the drive specifications would be retained, but those varistors in the lower half of the distribution, which draw larger current pulses for a given open-circuit transient voltage, would have been removed from the population of varistors. For instance, the range of nominal voltages for a 575 V, 32 mm varistor (the next higher voltage offered) is 805 to 1005 V for 1 mA dc, while the maximum nominal voltage of the same diameter but rated 510 V is 910 V for 1 mA dc. Thus, for a normal distribution of nominal voltages of the 575 V varistor, 50% of the devices could theoretically be used without exceeding the upper limit of the 510 V varistor that is consistent with the drive specifications. To achieve this end, it would be necessary for the supplier or user to make a careful determination of the nominal voltage on a population of 575 V varistors in order to retain only the lower half of the distribution (Figure 11).

## Other Remedies

In addition to the proposed upgrading of protection at the 460 V level, three other remedies could be considered: installation of surge arresters at the 2300 V level, installation of surge arresters at the 23 kV level, or a change in the circuits involved in the capacitor switching, designed to reduce the severity of the transients at their origin.

In general, the protection available from surge arresters tends to improve when the arresters are installed at higher circuit voltages. Thus, it is quite possible that arresters installed at the 2300 V primary of the 2300/460 transformer could provide a more effective clamping (and at the same time relieve some of the energy stress) than the varistors at the 460 V level. (It is of course implied that these would be the zinc-oxide type, gapless arresters.) The full benefit of these arresters depends on the configuration of the 2300 V system and its grounding (solidly grounded neutral in a wye system, resistance-grounded wye, or floating delta) when the arresters are connected in the conventional line-to-ground mode. In a second phase of the retrofit described here, 2300 V arresters were installed at the transformer primary. A discussion of their expected performance, validated by the success of the retrofit, is given later on.

Likewise, arresters on the 23 kV side could be installed at the 23 kV substation to mitigate the capacitor switching transients at their origin, or at the primary of the 23 kV/2300 V substation near the control house, where they would also serve as lightning protection for the overhead 23 kV incoming power line. These arresters, again, must be of the gapless type to obtain the most effective protection.

The final remedy in the list of alternatives, but perhaps the first in effectiveness when the opportunity exists, would be to attempt reducing the severity of the capacitor switching transients at their origin. Series inductors or damping resistors may be considered, the effectiveness of which would be predictable if a simulation of the power system behavior were performed by computer modeling. While that remedy could not be applied to this particular location, it is a remedy that should be considered for a similar case of exceptionally severe environment.

## EXPECTED PERFORMANCE OF THE 2300 V ARRESTERS

The measurements made first with open-circuit, then with the 20 mm, 510 V varistors on the 460 V side have shown a reduction of maximum voltage from 1450 V to 1100 V (Table 1) when a current of approximately 200 A is flowing in the line and varistors (Figure 5).

We can assume that the voltage drop in the line from the substation and two step-down transformers is mostly inductive at 5.5 kHz, and that the voltage in the varistors can be treated as the voltage across a resistor at the time of the crest of the current wave. The diagram of Figure 12 shows the relationship between the three voltages  $V_{OC}$ ,  $V_L$ , and  $V_V$ , respectively, the open-circuit voltage generated by the capacitor switching action, the voltage drop in the line and two transformers, and the varistor voltage at the current peak. Treating this highly nonlinear circuit as a linear circuit is an approximation that will provide at each point of the full range of voltage and current conditions a valid order of magnitude for the purposes of this discussion. Numerical methods are available for rigorous treatment at any instant over the full range of conditions [6]. With this simplifying assumption, we can determine the order of magnitude of the 5.5 kHz current that would flow in an arrester installed at the primary terminals of the 2300 V/460 V transformer as follows.

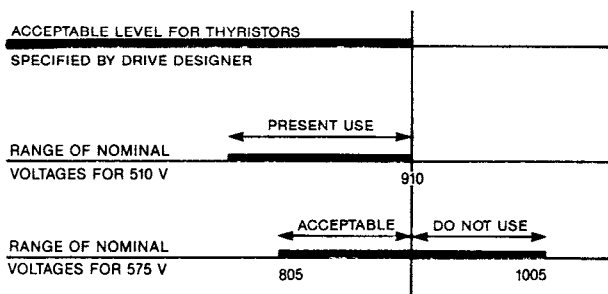

Figure 11. Tolerances bands of 510 V and 575 V varistors

- From the actual measured voltages shown in Figure 12, we derive the voltage drop,  $V_L$ , in the 23 kV line and two step-down transformers:

$$V_L = (1450^2 - 1100^2)^{1/2}$$

$$= 940$$

Thus, at 5.5 kHz, the impedance between the source and the varistor is

$$Z_L = \frac{V_L}{I}$$

$$= \frac{940 \text{ V}}{200 \text{ A}}$$

$$= 4.7 \Omega$$

Note that this  $4.7 \Omega$  impedance means that the 5.5 kHz switching transient, generated at a distance of about 3000 m (2 miles) from the point of measurement, and at the 23 kV level, can travel a long distance and pass through two step-down transformers with less attenuation than might be expected from the unsound but popular view that "surges cannot travel that far without substantial attenuation."

- We now arbitrarily assign equal values to the three elements of this impedance,  $Z_L$ : (1) the 23 kV line impedance; (2) the 23 kV/2300 V transformer; and (3) the 2300/460 V transformer. The impedance between the source and the primary of the 2300/460 V transformer is then two-thirds of the total impedance,  $Z_L$ , or about  $3 \Omega$  for the 460 V side of the transformer.
- On the 2300 V side, the impedance of  $3 \Omega$ , calculated above, becomes  $3 \Omega \times (2300/460)^2 = 75 \Omega$  and the open-circuit voltage of 1450 V which was measured on the 460 V side becomes  $1450 \text{ V} \times (2300/460) = 7250 \text{ V}$ .
- Knowing the open-circuit voltage and the impedance between the source and the 2300 V arrester, we can compute the current in the arrester by iteration if we assume some current value and read the corresponding clamping voltage on the I-V characteristic of the arrester:
  - Assume a current crest of 50 A, producing a drop of  $50 \times 75 = 3750 \text{ V}$  in the line and 23,000/2300 V transformer. Adding this voltage to the varistor voltage, corresponding to 50 A, which is read as about 5700 V on the arrester characteristic curve for minimum discharge voltage (Figure 13), we have  $(3750^2 + 5700^2)^{1/2} = 6780 \text{ V}$ , or somewhat below the expected 7250 V open-circuit voltage, which is to equal the quadratic sum of the two voltages  $V_L$  and  $V_V$ .
  - Assume, for a new iteration, a crest of 60 A, producing a drop of  $60 \times 75 = 4500 \text{ V}$ , while the varistor voltage remains essentially the same, i.e., 5700 V. The quadratic addition becomes  $(4500^2 + 5700^2)^{1/2} = 7210 \text{ V}$ , or a value close to the goal of 7250.
- Thus, we can expect that the 2300 V arrester will experience current pulses occurring in bursts not exceeding 60 to 70 A, with durations similar to those found on the 460 V varistors, i.e., 5 to 7 pulses per train, or a total duration in the order of 1 ms. Information on arrester duty available from the manufacturer indicates that, for a pulse train of that duration and a crest of less than 100 A, no limitation of the number of pulses need be imposed on the arrester as long as enough time is allowed between pulses to permit cooling of the arrester.

Furthermore, the 5700 V clamping level predicted for the 2300 V surge arresters at 60 A would be reflected as a crest of  $5700 \text{ V} \times 460/2300 = 1140 \text{ V}$  on the 460 V side. The 510 V, 32 mm varistors, connected in series with the impedance of the 2300/460 V transformer, would then be exposed to this maximum

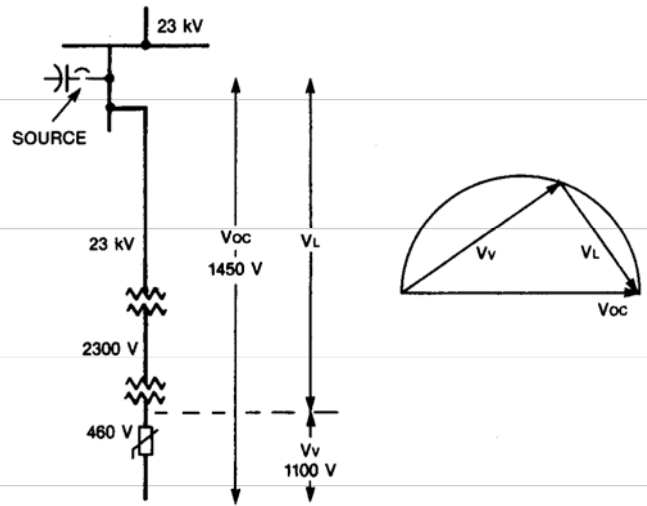

Figure 12. Open-circuit voltage and voltage drops in the system

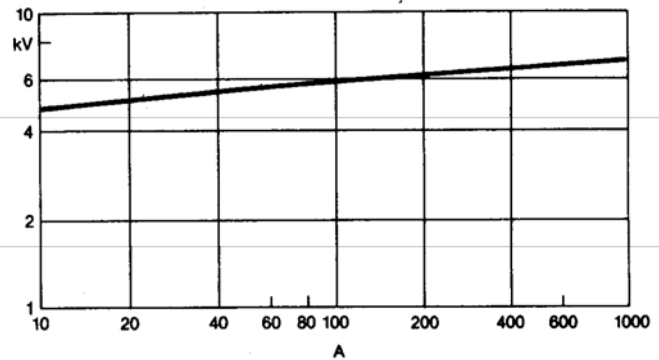

Figure 13. Minimum clamping voltage characteristic for 2300 V arrester

open-circuit voltage of 1140 V, a value much lower than the 1450 V open-circuit voltage that was applied to them in the absence of the 2300 V arresters. For that applied voltage, the current drawn by the varistor would be in the range of 10 to 20 A, values much lower than the 200 A measured without the 2300 V arrester. Computing the equivalent pulse, as was done in Figure 10 for the 200 A crests, would yield an equivalent crest of about 10 A, for which the pulse rating curves of the 32 mm series show more than 100,000 pulses before its rating is reached.

To place these large differences of performance and withstand capability into perspective, Table 2 shows the relative sizes and volumes of varistor material applied to the taming of the capacitor switching transient. In other words, the environment has now been matched by the capability of the varistors.

Table 2  
VARISTOR AND ARRESTER DIMENSIONS

Type	Diameter	Thickness	Volume
20 mm	1.8 cm	0.35 cm	0.9 cm <sup>3</sup>
32 mm	3.0 cm	0.35 cm	2.5 cm <sup>3</sup>
2300 V Arr.	6.1 cm	2.4 cm	70 cm <sup>3</sup>

## CONCLUSIONS

Voltage and current measurements made on the 460 V input to a thyristor motor drive, during staged capacitor switching operations, showed current surges in the varistors originally used in the system that could consume the pulse rating life of these varistors in a few days of typical operation. Short- and long-term remedies were achieved.

For the short term, the change to a larger varistor connected on the 460 V side of the system was readily implemented to maintain the originally specified protective level, while the fuse-blowing nuisances were eliminated by use of a larger fuse. Available devices for this 460 V circuit may still have a relatively short life (a few hundred days) in the prevailing environment of the site, but they offered immediate relief and therefore allowed successful startup of the system.

For the long term, further protection was obtained by the installation of conventional station-class surge arresters, of the zinc-oxide, gapless type, at the 2300 V level. The system has now operated for 3 years without problems.

This case history also illustrates the low attenuation of the switching transient between the distant source at 23 kV (about 3000 m, or 2 miles) and the point of utilization at 460 V.

## ACKNOWLEDGMENTS

J.S. Kresge and B.I. Wolff provided information and guidance on the surge arrester and the varistor characteristics; C.L. Fisher contributed advice in clarifying and unifying the presentation of the concepts. Their contributions are gratefully acknowledged.

## REFERENCES

- [1] F.D. Martzloff, "Matching Surge Protective Devices to their Environment," *Proc. IEEE/IAS Meeting, October 1983*, pp. 387-392. (Also scheduled for *IAS Transactions*, Jan/Feb 1985.)

- [2] ANSI/IEEE Std C62.33-1982, *IEEE Standard Test Specifications for Varistor Surge Protective Devices*, The Institute of Electrical and Electronic Engineers, Inc., New York.
- [3] A. Greenwood, *Electrical Transients in Power Systems*, Wiley Interscience, New York, 1971.
- [4] *Transient Voltage Suppression Manual*, Fourth Edition, General Electric Company, Auburn, NY, 1983.
- [5] *Transient Voltage Suppression Manual*, Third Edition, General Electric Company, Auburn, NY, 1983.
- [6] H.W. Dommel, "Digital Computer Solution of Electromagnetic Transients in Single and Multiphase Networks," *IEEE Transactions on Power Apparatus and Systems*, Vol. PAS-88, pp. 388-399, April 1969.

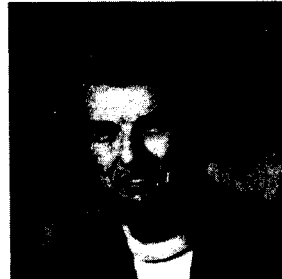

**François D. Martzloff (M'56, F'83)** was born in France, and received his undergraduate degree at the Ecole Spéciale de Mécanique et d'Electricité in 1951; he received the MS in Electrical Engineering degree from Georgia Tech in 1952 and the MS in Industrial Administration degree from Union College in 1971.

Since 1956 he has been with the General Electric Company, where he gained experience in the Transformer and Switchgear Division. Upon

joining General Electric Corporate Research and Development in 1961, he became involved in power semiconductor circuits and overvoltage protection. He has participated in the introduction and application of metal oxide varistors since 1971.

In IEEE, Mr. Martzloff is active on the Surge Protective Devices Committee. He is chairman of the Working Group on Surge Characterization in Low-Voltage Circuits. He is also a member of the Ad Hoc Advisory Subcommittee of the USA Advisory Committee on IEC S/C 28A, ANSI C.62 Subcommittee on Low-Voltage Surge Protective Devices, and Chairman of the NEMA Low-Voltage Arresters Technical Committee. He has been awarded 13 U.S. patents, primarily in the field of varistors and transient protection.



### Discussion

**J. L. Koepfinger** (Duquesne Light Company, Pittsburgh, PA): The author has addressed one of many mechanisms for producing repetitive over-voltages on low-voltage circuits. In this particular instance, it was possible to obtain controlled conditions so that a measurement could be made of the voltage and currents resulting from the capacitor switching. It would be useful if there was an analytical method presented that correlated the generation of the 5.5-kHz pulses with those measured. Did the author attempt to make such a correlation?

This paper points out the need to know the characteristic of the surge so that proper sizing of the protection can be achieved. Therefore it would be desirable to be able to have some analytical tool to permit calculation of the frequency of the surge due to remote capacitor switching.

Manuscript received July 24, 1985.

**Francois D. Martzloff:** The paper reported a case history from which useful information may be derived on retrofitting corrections of similar problems or, better, on avoiding the problem by foresight. The situations confronting the author was the need for immediate corrective action rather than complete investigation and mutual validation of analytical methods and field measurements.

The literature is fairly rich in both theoretical and practical papers on the problems associated with capacitor switching, both for energizing and for de-energizing, the latter involving the risk of restrikes. Because of this availability and the limited space available in the *TRANSACTIONS* on one hand, and because of the limitations in scope of the field retrofit mission on the other hand, no attempt was made to correlate the measurements with the power system parameters (which were not readily available to the author). In response to Mr. Koepfinger's suggestion, abstracts are cited below to provide references to both analytical tools and practical results published by other workers.

### Bibliography, 1970-1985 : REFERENCES

- [1] M. F. McGranaghan, W. E. Reid, S. W. Law, and D. W. Gresham, "Overvoltage Protection of Shunt-Capacitor Banks Using MOV Arresters," *IEEE Trans. Power App. Syst.*, PAS-103, No. 8, Aug. 1984, pp. 2326-2333.

Protection requirements and surge arrester duties are analyzed for both digital and transient network analyzer (TNA) simulations. Simple analytical expressions are developed for evaluating arrester duty as a function of capacitor bank size. Guidelines and limitations for applying arresters at grounded- and ungrounded-wye capacitor banks are developed based on overvoltage characteristics and arrester capabilities.

- [2] J. H. Brunke and G. G. Schoeckelt "Synchronous Energization of Shunt Capacitors at 230 kV," *IEEE PES (Power Eng. Soc.) Winter Meeting*, New York, NY; Jan. 20-Feb. 3, 1978; Publ. by IEEE 1977, Paper A78-148-9, p. 4.

This paper reports on the application of synchronous switching to reduce inrush transients when switching a 230-kV shunt capacitor bank. Computer studies determined the required switch performance.

- [3] J. D. Cuffman, John Linders, M. A. Zucker, and S. Willima, "Power Factor Correction Capacitors and Their Side Effects," *IEEE Conf. Rec.*, 28th Ann. Conf. Electr. Eng. Probl. Rubber Plast. Ind., Akron, OH, April 5-6, 1976, pp. 37-49.

The major reason for applying capacitors to an electrical distribution system is to correct poor power factor. In the greater majority of installations it is a routine procedure. In some instances capacitors may cause problems with other in-plant equipment and in other instances they may suffer undesirable side effects that originate in other equipment. Among these problems are switching surges, voltage unbalance due to fuses blowing, and harmonics generated by SCR-controlled equipment.

- [4] H. J. Yelland, and C. P. Yellna, "Vacuum Contactors: Latest Development in Their Design and Application," *Certif. Eng. V 54*, No. 1, Jan. 1981, pp. 824-841.

The paper includes the following topics: Design of vacuum bottles (glass and ceramic); design of the complete vacuum contactor and their panels; panels with on-load isolation, and panels with off-

load isolation; vacuum contactor applications (motor control), capacitor switching, arc and other (furnace-switching, transformer switching, mine-winder-reversers). Surge generation by vacuum contactors is considered under the following heads: basic energization and de-energization transients; transients generated when switching inductive loads; assessment of a vacuum contactor from a surge generation point of view; types of surge suppression devices; switching of capacitive loads. An extensive discussion of the paper is appended.

- [5] Jack R. Harbaugh and John E. Harder, "Important Considerations for Capacitor Applications in the Petroleum and Chemical Process Industries," *IEEE Pet. Chem. Ind. Conf.*, 27th Ann. Rec. of Conf. Pap., Houston, TX, Sept. 8-10, 1980; *IEEE*, #80CH1549-5 IA), Piscataway, NJ, pp. 157-167.

The location of capacitors may have a significant effect of the ( $I^2R$ ) losses within the plant transformers and conductors, which is wasted energy. Transients generated by capacitor switching may require attention in the selection of arresters, system insulation, or other equipment. The presence of capacitors may require some special attention to large motors during system reclosing or load transfer. This study addresses each of these considerations, providing some guidelines for effective, reliable capacitor application. In addition, a checklist is provided for general industrial capacitor applications.

- [6] J. F. Burser, R. J. Santoro, J. W. Stolle, R. E. Owen and C. R. Clinkenbeard, "Comparative Evaluation of Field Test Data and Computer Results on Capacitor Switching Transients," *Meeting Minutes PA Electr. Assoc., Eng. Sect., Trans. and Distrib. Comm. West Middlesex, PA*, May 15-16, 1979; *PA Electr. Assoc., Eng. Sect., Harrisburg, PA* 1979.

An arrester failure case was analyzed occurring at the time of substation capacitor bank switching with the use of a transient network analyzer (TNA) and digital computer techniques. The case involved a 12.5-kV ground-wye distribution system. Results of the TNA study, which were validated by field tests, showed the effects of system configuration magnitude of transient over voltages.

- [7] Eldon J. Rosers, and Don A. Gilles, "Shunt Capacitor Switching EMI Voltages, Their Reduction in Bonneville Power Administration Substations," *IEEE Trans. Power App. Syst.* PAS-93, No. 6, Nov.-Dec. 1974, pp. 1849-1860.

Back-to-back switching of grounded wye shunt capacitors cause high frequency, high-magnitude current flow in overhead bus and ground mat conductors. Measurements of induced voltages on control cables and receptacles, transverse voltages on fuse blown PT secondaries and personnel intercept voltages are reported. BPA methods of confining transients to capacitor areas and shielding techniques are reviewed.

- [8] Paul C. Krause and William C. Mauser, "On-Line Transient Control of Capacitor Switching to Improve System Stability," *IEEE Trans. Power App. Syst.* PAS-92, No. 1, Jan-Feb. 1973, pp. 321-329.

A simplified voltage-reactance equivalent of the one-machine infinite bus system was used. The material presented in this paper shows that this simplified model does not predict the performance of a one-machine infinite bus system with the accuracy necessary to determine the capacitor switching times so as to achieve the control objectives. However, it is shown that computation accuracy may be improved by including system losses. It appears that in order to apply optimal control techniques it will be necessary to develop more accurate models of the power system components. Also, faster than real time iterative, on-line computation techniques as simulated in this paper should be implemented and used to calculate the switching times. Until these obstacles are overcome, optimal control theory will have little impact upon the power industry.

- [9] D. O. Wiitanen, J. D. Morgan, and G. L. Gaibrois, "Station Capacitor Switching Transients, Analytical and Experimental Results," *IEEE Trans. Power App. Syst.* PAS-90, No. 4, July-Aug. 1971, pp. 1639-1645.

Station capacitor bank energization transients predicted by a circuit model are compared to field-test results. Selection of a suitable model is discussed. A computer solution of the model is presented.

Manuscript received September 19, 1985.