

# Applying Reality Checks to Standards on the Surge Environment

**Arshad Mansoor** Power Electronics Applications Center Knoxville TN 37932 USA [Amansoor@epri-peac](mailto:Amansoor@epri-peac)

**François Martzloff** National Institute of Standards and Technology Gaithersburg MD 20899 USA [f.martzloff@ieee.org](mailto:f.martzloff@ieee.org)

**Doni Nastasi** Power Electronics Applications Center Knoxville TN 37932 USA [DNastasi@epri-peac.com](mailto:DNastasi@epri-peac.com)

Reprinted with permission from *Proceedings, 23<sup>rd</sup> International Conference on Lightning Protection, Florence, 1996*

## **Significance:**

Part 2 Development of Standards – Reality checks

Three examples of reality checks are given that shed some light on issues raised during standards development

- The apparent reduction in surge voltage activity is explained by the proliferation of surge mitigating devices.
- A proposed high-energy surge would cause failure of ubiquitous SPDs, but they do not fail in the field.
- Allegedly frequent high-level surges would cause frequent failure of light bulbs, but they do not in the field

# APPLYING REALITY CHECKS TO STANDARDS ON THE SURGE ENVIRONMENT

Arshad Mansoor and Doni Nastasi  
Power Electronics Applications Center  
Knoxville TN USA

François D. Martzloff  
National Institute of Standards and Technology \*  
Gaithersburg MD USA

**Abstract** - The paper identifies several realities of surge environment and equipment survival that are sometimes ignored in surge-protection practices. It questions the quest for what could be overly conservative requirements for surge immunity or surge mitigation by presenting "reality checks" based on field experience or laboratory data. A first check focuses on the fact that some recent field recordings of surges may be misleadingly low in today's surge environment. Additional checks, aimed at moderating the overly conservative requirements, include the case history of a proposed high-stress 100/1300  $\mu$ s surge test, data on failure levels of clock motors and light bulbs that can serve as benchmarks for severity levels, and measurements, validated by parametric modeling, showing that large currents cannot propagate into long cables without causing a flashover of the wiring devices at the beginning of the cable, effectively limiting the energy-delivery capability of a surge at the end of the cable.

## 1. Introduction

Some proposals for standards on equipment surge immunity or on performance of surge-protective devices are driven by the commendable quest for conservative ratings. However, when this quest produces compounded safety factors, the result may not be cost-effective.

The purpose of our paper is to present facts and rationalizations in support of the development of realistic standards on the surge environment in low-voltage ac power systems. In addition to contributors to the ICLP Conferences, two major players in the development of international standards on the lightning surge environment are IEC Technical Committee 77 on Electromagnetic Compatibility and Technical Committee 81 on Lightning Protection. Other contributors addressing switching surges as well as lightning surges include IEC Subcommittee 28A on Insulation Coordination, Subcommittee 37A on Surge-Protective Devices, and the IEEE Committee on Surge-Protective Devices. The standards developed by these bodies reflect the collective experience of individual contributors as well as the "corporate memory" of these groups. In this paper, four items are described that may serve as foundations, or reality checks, to be added to this corporate memory. The first check can be seen as a reminder note to resist the mistake of dismissing surge threats because contemporary recordings show benign occurrences of surge voltages. The three other checks can serve as a tempering note, to avoid economically unjustified over-specification of surge protection.

## 2. The ninety-five percent rule

Debates and definitions concerning compatibility levels, immunity limits, or emissions limits generally acknowledge that requirements drawn from these considerations cannot apply simultaneously to 100% of the cases and 100% of the time. The term "high probability" appears in many definitions, rather than a hard number. This avoidance of hard numbers is the result of the difficulty to secure a consensus from individuals who represent different communities of end-users with different perceptions of what is an acceptable level of probability.

The military and aerospace communities often speak of zero tolerance or zero defects where economics is downplayed. In contrast the commercial, mass-production communities speak of realistic requirements where cost-effectiveness is a very prominent factor.

An intermediate position can be found in industry where a rational balance is sought between the costs of exhaustive mitigation and the consequential costs of limited mitigation.

Our reality checks are offered as a guide to striking such a balance, recognizing the diversity of circumstances and expectations from a diversity of end-users.

## 3. Shrinking surges vs. expanding mitigation

A reality check can explain an apparently puzzling development which has been observed since the beginning of studies concerning the characterization of the surge environment: starting in the sixties, results published by researchers monitoring the occurrence of surges have reported a gradual decrease in the relative severity of surges (Martzloff & Hahn, 1970 [1]; Allen & Segall, 1974 [2]; Bull & Nethercott, 1975 [3]; Goldstein and Speranza, 1982 [4]; Goedbloed, 1987 [5]; Dorr, 1995 [6]).

This puzzling trend can be explained by reference to the reality: the spectacular expansion of surge-protective devices (SPDs) in low-voltage ac power circuits now makes it almost impossible to make measurements at a site where there is not some hidden SPD. Monitors will now report the residual voltage of these SPDs, not the true surge activity in the environment (Aspnes et al. and discussion, 1985 [7]). So, it is not that surges have shrunk, but rather that mitigation has greatly expanded, masking the persistent occurrence of transients which remain a potential threat. This threat has shifted from observed surge voltages -- now mitigated -- to the possibility of excessive surge currents into candidate mitigation means with low limiting voltage which would be particularly attractive to the surges.

\* *Electricity Division, Electronics and Electrical Engineering Laboratory, Technology Administration, U.S. Department of Commerce.*

Future surveys of the occurrence of surges in low-voltage ac power systems should shift from the recording of surge voltages to the recording of surge currents [8]. Unless this shift is implemented, the false sense of security will be further promoted that potentially damaging surges are less frequent than once believed. The 1980 title of a seminal IEEE document on the occurrence of surges (Guide on Surge Voltages in Low-Voltage AC Power Circuits [9]) was appropriate at the time, but should now be amended to reflect the shift.

#### 4. The saga of the proposed 100/1300 $\mu$ s surge

A proposal was made in the early eighties to require a high-stress surge test for industrial equipment. A reality check would have revealed the contradiction between the failure rates that would result from such a test and the observed field failures.

Starting with observations of the occurrence of long duration surges, typically associated with fuse blowing, the proposal was to require an additional test with a surge longer than the classic 1,2/50 - 8/20  $\mu$ s impulse (Meissen, 1983 [10]; VDE 0160, 1989, [11]; IEC 1000-4-1, 1990 [12]). The proposed surge would be characterized by a 100/1300  $\mu$ s waveform, with peaks as high as 1,3 per unit, added to the ac sine wave peak. In the original VDE 0160 implementation, the test circuit involved the discharge of a 24000  $\mu$ F energy-storage capacitor. An amendment to the VDE 0160 standard [13] scaled the capacitance value down to 6000  $\mu$ F, still a large stress for the equipment under test.

For instance, such surges would impose large stresses to the millions (or perhaps billions) of small varistors now installed in low-voltage ac power systems. One would observe a conspicuous failure rate in the field as typical 20-mm diameter varistors cannot survive such surges, but one does not observe this failure rate. An objection to this surge specification was first proposed on the basis of computer simulation of the event (Fenimore & Martzloff, 1990 [14]) because no generator was commercially available to produce that surge. Table 1 shows an excerpt from [14] where the current that would be caused by the proposed 100/1300  $\mu$ s surge in a 20-mm varistor rated 250 V rms was computed and compared to the published varistor pulse rating for current-handling capability. Only a varistor at the high end of its  $\pm 10\%$  tolerance band could survive one application of that surge (the corresponding computed current peak is only 269 A, compared to a rating of 300 A). In all the other cases, the varistor rating is exceeded and likelihood of failure increases for lower tolerances and for more than one pulse.

Later on, when a prototype generator capable of delivering this surge was developed by a surge generator manufacturer, tests witnessed by one of the authors and by W. Meissen (the originator of the 100/1300  $\mu$ s surge proposal), did confirm the fact that 20-mm varistors are destroyed by that surge (Martzloff, 1991 [15]). We now understand that the IEC proposals and the VDE 0160 requirements for the 100/1300  $\mu$ s surge have been pulled back or are being reconsidered.

Table 1  
Computed peak currents for a postulated 100/1300  $\mu$ s surge and varistor rated peak current

Tolerance on varistor nominal voltage rating (%)	Computed results: Current peak and duration of surge in the varistor		Varistor rating: Allowable peak A for number of pulses of computed FWHM		
	Peak (A)	FWHM* ( $\mu$ s)	100 pulses	10 pulses	1 pulse
- 10	658	625	45	80	210
0	454	515	55	90	250
+10	269	400	65	110	300

\*FWHM: Full width at half maximum

#### 5. Failure levels of clock motors and incandescent light bulbs

Two simple devices have been in service in millions of households and can be seen as surge threshold detectors: motor-driven clocks (before the advent of digital clocks) and still today, the ubiquitous incandescent light bulb. We have some knowledge on the failure rate of some of these devices under surge conditions, from which we can derive some inferences on approximate limits on the level of frequent surges. As we will see in the following two subsections, the data are not precise and are subject to undetermined statistical variations. However, the large number of observations does give some value to the inferences, compared to the limited number of observations obtained by more precise recording instruments.

##### 5.1 Failures of motor-driven clocks

In the sixties, a report was published citing a 100:1 reduction in the failure rate of clock motors when the withstand level of the motor was raised from 2 kV to 6 kV [9], thus providing a verification of the "slope" of surge occurrence rate vs. peak reported by many researchers [16].

Figure 1 shows a plot of the frequency of occurrence of surge voltages versus their peak amplitude as reported by many researchers, and the two-point line of the 100:1 relationship between 2 kV and 6 kV occurrences. The parallel position of all these lines is remarkable. While the plots reported by the researchers are generally limited to a few thousand hours of observation, at only a few locations, the clock data represent the integration of more than 10000 clocks over a period of two to three years.

Because the data reflect only the number of clocks returned by dissatisfied customers, the exact number of clocks involved in "monitoring" the surge voltages, and the duration of the observation are not known. Therefore, rigorous statistical analysis would be meaningless. The point of our reality check, however, is still that a very large number of observation points were involved, for a period of several years, something that no survey could do -- but for this particular case history, it was all done before the environment began to be tamed by the proliferation of the new generation of low-voltage SPDs.

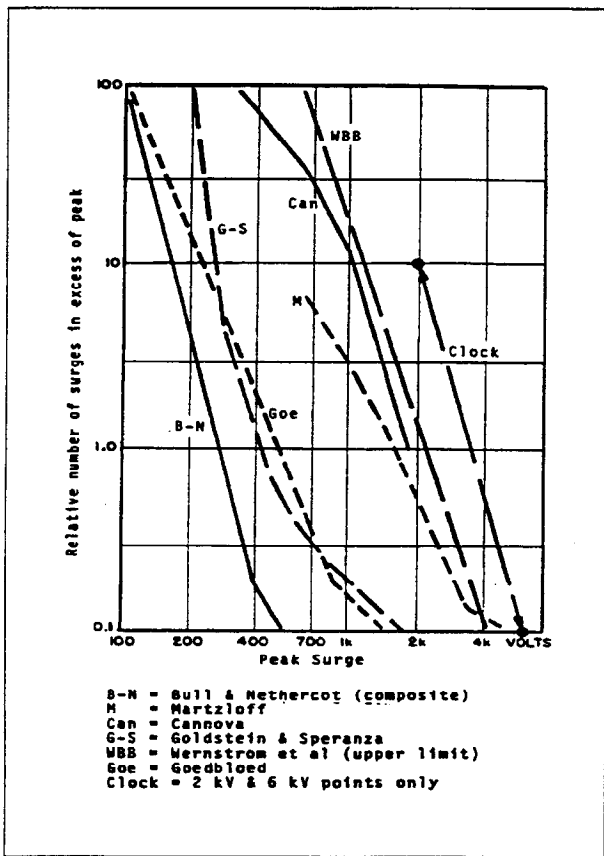

Figure 1 - Plots of frequency of occurrence versus peak amplitude reported in 1970-1987 surveys by independent researchers. The line marked "clock" only shows the slope from 2 kV to 6 kV, not the actual frequency of occurrence. Note how the lines are essentially parallel. (Plot reproduced from [16].)

### 5.2 Failure of incandescent light bulbs under surges

Tests recently performed by the authors on 120-V incandescent light bulbs show that few bulbs will survive surges in excess of 1200 to 1500 V †, and that a surge of as little as 800 V, when it occurs under the most sensitive condition, can trigger the failure. Limited tests performed on 240 V bulbs yield similar results. Comparison of tests performed by a researcher in Austria and by the authors on both 120 V and 240 V bulbs might be available at the time of presentation of this paper.

Since we do not hear reports of endemic failure of light bulbs beyond what can be expected from their known service life, we must conclude that the reality is that there is not a high rate of occurrence of surges at levels in excess of 1500 V.

† The measurements reported in this paper have been made with instrumentation for which the combined uncertainty should not exceed  $\pm 5$  to  $\pm 6\%$ . Given the process of applying the measurement results to the failure levels of light bulbs exposed to environments with characteristics that are at best known within an order of magnitude, this level of uncertainty does not affect the practical conclusions.

This observation merits a brief summary of our findings about the mechanism of bulb failure *triggered* by a surge. We emphasize the triggered aspect because surges of relatively low amplitude do not cause directly the failure of the bulb, but cause a secondary flashover at the power frequency that burns out the filament. Surges of higher amplitudes can deposit enough energy into the filament to melt it, but our point for the reality check is that even low-amplitude surges can result in failure of the bulb.

Figures 2, 3, 4, and 5 present oscillograms of the voltage across an energized 120-V bulb and of the current flowing in the bulb. Figure 2 shows a narrow window commensurate with the duration of the surge delivered by a 1,2/50  $\mu$ s - 8/20  $\mu$ s surge generator. We observe the chopping of the voltage wave, typical of a gap sparkover, and the rise of the surge current after the sparkover. The scale of the current trace selected to record the surge (hundreds of amperes) does not show the normal current (1 A) in the bulb. Observations during this test include hearing a pinging noise and seeing a bright flash of light, followed by darkness as the filament can then be seen broken at its points of attachment to the stems.

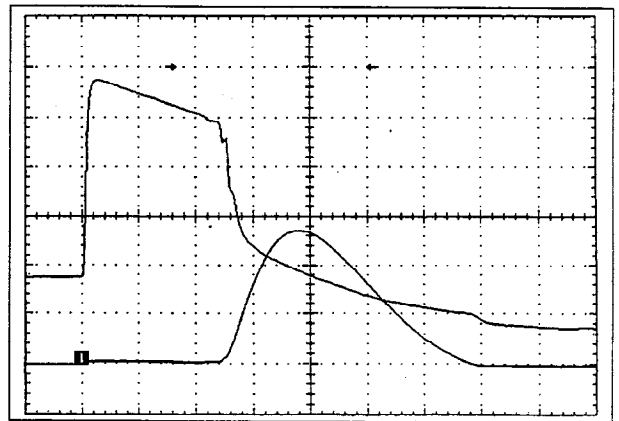

Top trace: Voltage across bulb terminals, 200 V/div  
Bottom trace: Current in bulb, 100 A/div  
Sweep: 10  $\mu$ s/div

Figure 2 - Voltage and current in light bulb during application of a 1,2/50  $\mu$ s - 8/20  $\mu$ s surge, resulting in surge sparkover

Figure 3 was recorded (for a new bulb) with a longer window to display two full cycles of the power frequency. At that sweep rate, the surge is no longer resolved, and its apparent peak on the trace may be lower than the actual peak because not enough data samples are collected around the peak. However, the timing of the surge, and the events following the surge are what is important in this figure. The surge event appears as a voltage spike and a current spike, followed by return to practically normal voltage and no visible large current. Then, suddenly, a pulse of power-frequency current appears, with a large amplitude -- the source of the observed flash. We believe that it is this current that causes the burn-out of the filament, not the "trigger" surge.

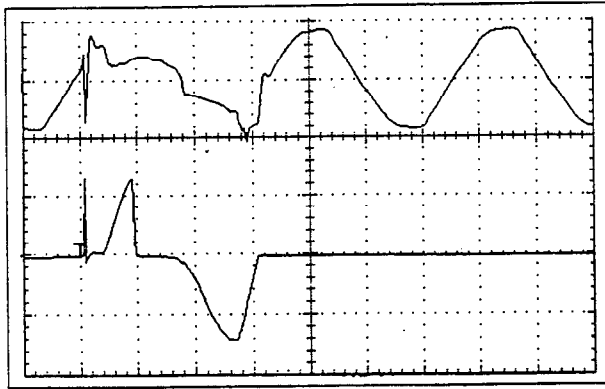

Top trace: Voltage across bulb terminals, 200 V/div  
 Bottom trace: Current in bulb, 100 A/div  
 Sweep: 5 ms/div

Figure 3 - Voltage and current in light bulb during application of a 1,2/50  $\mu$ s - 8/20  $\mu$ s surge at 30°, resulting in surge sparkover, followed by power-frequency flashover

This belief is supported by the recordings shown in Figures 4 and 5. Figure 4 is actually the recording of a surge application to the bulb of Figure 3, in a test that preceded the fatal surge recorded in Figure 3. The applied surge was the same (900 V) for both Figure 3 and Figure 4. The randomness of the process of igniting the power arc is such that in the case of Figure 4, the power arc was not ignited, while in the subsequent surge application on the same bulb (Figure 3) and in the same conditions, the power arc was ignited, resulting in burn-out of the filament.

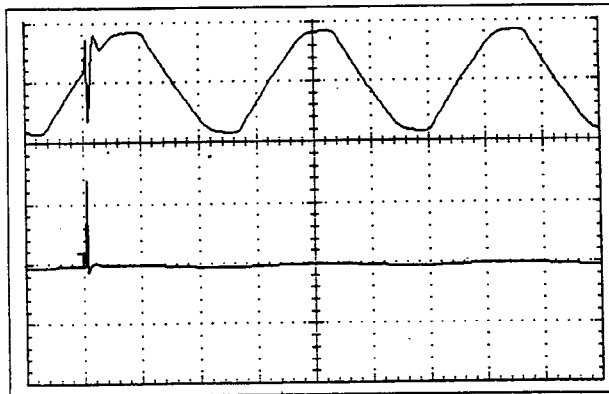

Top trace: Voltage across bulb terminals, 200 V/div  
 Bottom trace: Current in bulb, 100 A/div  
 Sweep: 5 ms/div

Figure 4 - Voltage and current in light bulb during application of a 1,2/50  $\mu$ s - 8/20  $\mu$ s surge at 30°, with surge sparkover but no power-frequency flashover

As further evidence, Figure 5 shows the process (in a new bulb) when the surge was applied at zero degrees, the time at which there is the least power-frequency voltage to ignite a power arc. In that test sequence, the first applied surge had an amplitude of 1000 V. Sparkover under the impulse did occur (the pinging noise was heard), but the power-frequency arc was not ignited and the bulb survived.

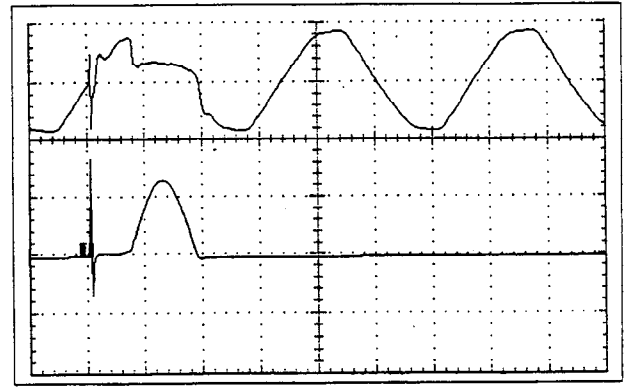

Top trace: Voltage across bulb terminals, 200 V/div  
 Bottom trace: Current in bulb, 100 A/div  
 Sweep: 5 ms/div

Figure 5 - Voltage and current in light bulb during application of a 1,2/50  $\mu$ s - 8/20  $\mu$ s surge at 0°, resulting in surge sparkover and delayed power-frequency flashover

The applied surge was then raised in 100 V steps, still with pinging heard but no fatal power-frequency arc. Figure 5 was recorded when the applied surge voltage was increased to 1300 V. At that level of energy deposited by the surge, enough plasma was generated in the path of the surge current to eventually ignite the power-frequency arc, but it had to wait until the power-frequency voltage had reached its peak.

To conclude this summary, Table 2 shows the relationship between the timing of the surge with respect to the sine wave and the amplitude of the surge sufficient to trigger ignition of the power-frequency arc. When the surge is applied at 90 degrees (the peak of the sine wave, making immediate ignition of the power arc easiest), a surge of 800 V is sufficient to trigger the power arc. At zero degrees, the surge must be raised to 1500 V to produce sufficient plasma to result in a subsequent power-frequency arc.

The phenomena are of course subject to the statistical variations of sparkover. The values shown in Table 2 are the averages of tests performed on a total of 20 bulbs of the same manufacturer, rated 100 W, replicating the test at several timing angles. This paper is not the medium for reporting in detail our series of experiments with other manufacturers and other watt ratings which produced similar results; the point is, however, that our inferences are not based on just the 20 bulbs of Table 2.

Table 2

Relationship between timing angle of the surge and amplitude necessary to produce a fatal power-frequency flashover

Angle (°)	0	15	30	45	90	135	150	165*
Peak (V)	1500	1200	900	800	800	850	850	1100

\* One specimen produced "pinging" starting at 1000 V, but no power arc. Eventually, the bulb failed at 1600 V without power arc, as a direct result of the energy dumped into the filament by the surge alone.

## 6. Limits to pushing surges into branch circuits

Some proposals have been made to require SPDs intended for installation on indoor circuits to withstand surges with relatively high peaks and short rise time. Such a requirement would mean that a substantial voltage drop would be developed ( $L \cdot di/dt$ ) along the wiring. Added to the limiting voltage of the SPD at the end of the line, the voltage necessary to drive such a surge at the origin of the line would very likely cause flashover of wiring devices at the origin of the line.

This flashover, occurring during the rising part of the surge, would effectively shut off further propagation of the surge toward the SPD (except for the energy stored in the line during the current rise, which is easily dissipated by the SPD). Thus, the requirement of a large surge capability for SPDs installed with even a modicum of line length would be unrealistic. In support of this statement, we present here a summary of measurements on actual wiring and EMTP [17] computer simulation of a range of parameters.

Figure 6 shows the experimental circuit with a varistor connected at the downstream end of a "branch circuit" consisting of two copper conductors of 2-mm<sup>2</sup> cross-section (#12 AWG), typical of residential wiring. The first current transformer monitors the total current impinging at the upstream end. The second current transformer monitors the current flowing toward the downstream end, which will be imposed on the varistor. The clearances at the upstream end, such as clearances in a service-entrance panel, are represented by a discrete gap that can be set to produce sparkover at some given voltage during the test as well as in the model.

To determine the response of the circuit without the clearance limitation and verify that the model produces the same result, the gap setting was adjusted for this particular test so that no sparkover occurred at the upstream voltage developed for the current delivered by the generator. Once the model was validated, parametric variations could be performed for any combination of circuit length, applied surge, and clearance (gap) sparkover.

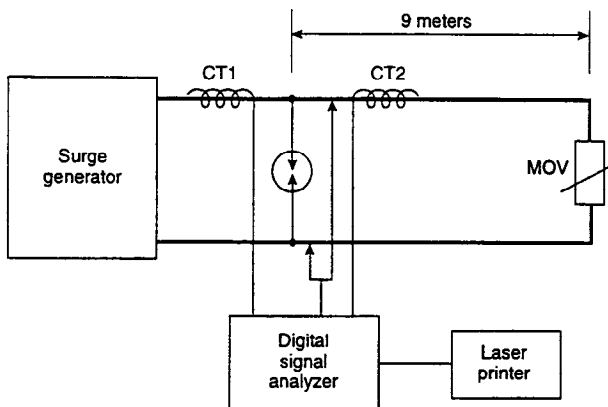
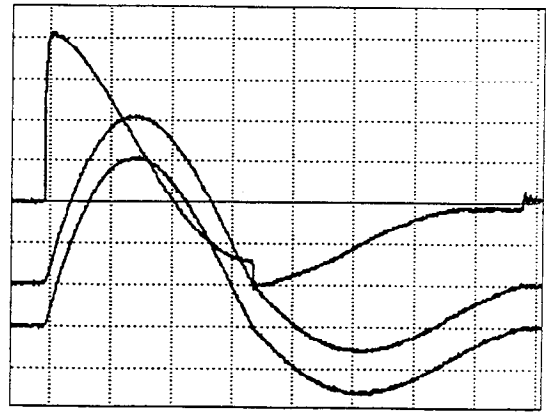

Figure 6 - Test setup for driving surges into a varistor installed at the end of a 9 m branch circuit.



Top trace: Gap voltage, 500 V/div  
Center trace: Total current, 500 A/div  
Bottom trace: MOV current, 500 A/div  
Sweep: 10  $\mu$ s/div

Figure 7 - Voltage and currents measured in the circuit of Figure 6

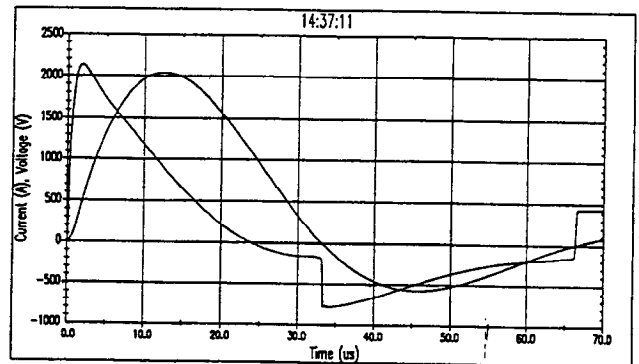

Figure 8 - Plot from model of voltage across the gap (compare with voltage trace of Figure 7) and impinging current (compare with the two current traces of Figure 7) for the circuit of Figure 6

Inspection of Figures 7 and 8 clearly shows the agreement between real-world measurements and model. The voltage traces are quite comparable. In Figure 7, the two current traces are identical since no current is diverted in the arrester. In Figure 7, the current trace is the one postulated in the modeling. This correspondence allows us to make parametric variations in the model with postulated impinging surges of higher values, such as those being proposed for consideration in some standards-writing groups. Another advantage of the model is that it allows postulating a current source -- the consensus choice among lightning researchers -- rather than using a surge generator which is only a charged capacitor with a wave-shaping network. Consequently, the surge generator interacts with the circuit into which the surge is injected, changing the waveform and losing the postulated constant waveform. This changing of the waveform makes it more difficult to perform parametric tests, compared to the ease of modeling. Table 3 below shows the results of such computations for the current waveform of Figures 7 and 8.

Table 3

Computed upstream voltage (in kV) necessary to drive a current of the peak value shown (columns) and rise time of 10  $\mu$ s into a branch circuit of length as shown (rows), terminated with a 130-V rated varistor

Peak Length	2 kA	3 kA	5 kA	7 kA	10 kA
10 m	2,3	3,3	5,2	7,2	10,1
30 m	5,8	8,5	13,9	19,4	27,0
50 m	9,3	13,7	22,7	31,6	45,0

As mentioned above, the insertion of an inductance in the load connected to the surge generator increased the rise time beyond the standard 8  $\mu$ s. In making the parametric computations, we chose to stay with this 10  $\mu$ s value to maintain continuity with the test/model validation.

Typical wiring devices used in 120-V installations have minimum flashover points in the range of 5 to 8 kV (this as a result of prevailing clearance requirements rather than insulation withstand levels as recommended by IEC Publication 664 [18]). Comparing this flashover level with the voltage values of Table 3 shows that, indeed, there is a strong possibility that within the range of current levels and branch circuit lengths of the table, a flashover would occur to throttle further propagation of the surge toward the varistor at the end of the branch circuit. In other words, postulating ever-larger surge currents into ever-longer branch circuits leads to a contradiction with the physical reality of the eventual occurrence of self-limiting flashover. This paradox has been discussed in greater details in a paper dedicated to that very subject [19].

## 7. Conclusions

1. Reality checks on the surge environment can bring a sense of perspective and help developing realistic standards for performance and application of surge-protective devices. This perspective can help avoid both over- and under-specification.
2. The proliferation of surge-protective devices in low-voltage ac power systems has made the recording of surge *voltages* practically irrelevant at best, and misleading at worst because the recorders indicate the let-through voltage of the SPDs, not the impinging surge. Surveys of the surge environment should focus on the ability (threat) of a surge to deliver a *current* to those ubiquitous surge-protective devices.
3. Field failure rates of various devices for which the failure level is known can provide some realistic and useful information on the rate of occurrence and level of surges in the environment.
4. Modeling the propagation of surges in a circuit, in particular computing the resulting voltages and comparing them with the known withstand level of insulation can provide a restraining influence on over-specifying surge protection requirements.

## 8. Acknowledgments

Support for the development of this paper was provided by the Power Quality research groups of Delmarva Power & Light, and Pacific Gas & Electric. Support for the testing and modeling was provided by the Electric Power Research Institute.

## 9. References

1. Martzloff, F.D. and Hahn, G.J., "Surge Voltages in Residential and Industrial Power Circuits," *IEEE Transactions PAS-89*, No.6, July/August 1970.
2. Allen, G.W. and Segall, D., "Monitoring of Computer Installations for Power Line Disturbances," *IEEE Winter Power Meeting Conference Paper WINPWR C74*, 1974.
3. Bull and Nethercott "The Frequency of Occurrence and the Magnitude of Short Duration Transients in Low-voltage Supply Mains," *The Radio and Electronic Engineer*, Sept 1964.
4. Goldstein, M. and Speranza, P., "The Quality of U.S. Commercial AC Power," *IEEE-INTELEC Conference Proceedings*, 1992.
5. Goedbloed, J.J., "Transients in Low-Voltage Supply Networks," *IEEE Transactions EMC-29*, No.2, May 1987.
6. Dorr, D.S., "Point of Utilization Power Quality Study Results," *IEEE Transactions IA-31*, No.4, July/August 1995.
7. Aspnes, J.D., Evans, B.W., and Merritt, R.P., "Rural Alaska Electric Power Quality," *IEEE Transactions PAS-104*, No.3, March 1985.
8. Martzloff, F.D., "Surge Recordings That Make Sense: Shifting Focus from Voltage to Current Measurements," *Proceedings, EMC '96 Roma*, September 1996.
9. IEEE Std 587-180, *IEEE Guide on Surge Voltages in AC Power Circuits*, now updated as ANSI/IEEE C62.41-1991, *Recommended Practice on Surge Voltages in AC Power Circuits*.
10. Meissen, W., "Überspannungen in Niederspannungsnetzen" *Elektrotechnische Zeitschrift*, Vol. 104, 1983.
11. VDE 0160, *Ausrüstung von Starkstromanlagen mit elektronischen Betriebsmitteln*, May 1988.
12. IEC Publication 1000-4-1, *Electromagnetic Compatibility, Part 4: Immunity Tests, Section 1: Overview of Immunity tests*, 1992.
13. VDE 0160A1, *Anderung 1 zu DIN VDE 0160/05.88*, 1989.
14. Fenimore, C. and Martzloff, F.D., "Validating Surge Test Standards by Field Experience: High-Energy Tests and Varistor Performance," *Conference Record, IEEE-IAS Annual Meeting*, 1990. Also in *IEEE Transactions IA-28* No.6, 1992.
15. Martzloff, F.D., "Testing Varistors Against the VDE 0160 Standard," *Open Forum on Surge Protection Application, NISTIR-4654*, 1991.
16. Martzloff, F.D. and Gruz, T.M., "Power Quality Site Surveys: Facts, Fiction, and Fallacies," *IEEE Transactions IA-24*, No.6, 1988.
17. EPRI, "Electromagnetic Transient Program (EMTP), Version 2.0; Volume 1: Main Program; Volume 2: Auxiliary Routines," EPRI Report EL-6421-L, July 1989.
18. IEC Report 664-1980, *Insulation coordination within low-voltage systems, including clearances and creepage distances for equipment*.
19. Mansoor, A. and Martzloff, F.D., "Driving High Surge Currents into Long Cables: More Begets Less," Presented at IEEE-PES Summer Meeting, Denver CO, July 1996, to be published in *IEEE Transactions PWRD* at later date.