

The protection of computer and electronic systems against power supply and data lines disturbances

François Martzloff
General Electric Company
Schenectady NY

Reprint of unclassified *GE TIS Report 85CRD084*, July 1985

Significance

Part 6: Tutorial, textbooks and reviews

A comprehensive review of the subject, summarizing the last several years of experience under the banner of the General Electric Corporate Research and Development.

Topics include description of the origin of transients, standards on the environment and tests, surge propagation and monitoring, fundamental protection techniques, surge-protective devices, case histories.

TECHNICAL INFORMATION SERIES

| | | |
|---|---|---|
| <small>AUTHOR</small> Martzloff, FD | <small>SUBJECT</small> computer protection — upset and damage | <small>NO.</small> 85CRD084 |
| | | <small>DATE</small> July 1985 |
| <small>TITLE</small> The Protection of Computer and Electronic Systems Against Power Supply and Data Lines Disturbances | | <small>GE CLASS</small> 1 |
| | | <small>NO. PAGES</small> 38 |
| <small>ORIGINATING COMPONENT</small> Automation Systems Laboratory | | <small>CORPORATE RESEARCH AND DEVELOPMENT</small> SCHENECTADY, N.Y. |
| <small>SUMMARY</small> <p>The irresistible trend toward distributed computing systems may be a source of difficulties which the earlier, centralized arrangement had overcome: surge voltages and surge currents injected or induced into power supply lines and communication (data) lines. These surges may be produced by lightning, by power system switching, or by differences in the potential of points expected to be grounded. Uninformed users of terminal equipment and personal computers may also connect their equipment in a manner inviting difficulties.</p> <p>This report presents a summary of present knowledge concerning the occurrence of surges together with mitigating measures and recent case histories illustrating the pitfalls of inappropriate applications.</p> | | |
| <small>KEY WORDS</small> surges, transients, interference, computers, upset | | |

INFORMATION PREPARED FOR _____

**Additional Hard or Microfiche Copies
Available from**

**Technical Information Exchange
Bldg. 5 Room 321, Schenectady, N.Y. 12345**

THE PROTECTION OF COMPUTER AND ELECTRONIC SYSTEMS AGAINST POWER SUPPLY AND DATA LINES DISTURBANCES

François D. Martzloff

1. INTRODUCTION

The irresistible trend toward greater numbers of distributed computing systems may be a source of difficulties which the earlier, centralized systems had overcome: surge voltages and surge currents injected or induced into power supply lines and communication (data) lines. These surges may be produced by lightning, by power system switching, or by differences in the actual potential of points expected to be at ground potential but which are, in fact, driven apart by a surge current. Uninformed users of terminal equipment or personal computers might also connect their equipment in a manner inviting difficulties. Another source of transients, not covered in this report, is static discharge.

A different source of disturbances for computers is, of course, undervoltage transients, sometimes called "sags." These are largely due to power system switching or faults, some being the consequence of lightning. Unfortunately, it is more difficult to fill a void in the power delivery than to divert and block an excess energy, so that the techniques needed to protect computer systems against these sags require approaches and equipment different from those discussed in this report, whose scope is limited to overvoltage or over-current surges. A number of approaches for mitigation of externally caused sags have been successfully implemented by computer manufacturers and users. These approaches range from power supplies with sufficient storage capacity or motor generator sets with sufficient mechanical inertia to ride through short sags, to uninterruptible power supplies with storage batteries and solid-state inverters being instantaneously switched to take over a failing utility power supply. These are now classical remedies and, when properly applied, eliminate the problems of sags, while the problems associated with surges still seem to be with us. This report presents a summary of present knowledge on the occurrence of surges and on mitigating measures, with recent case histories illustrating the pitfalls of inappropriate applications.

2. THE ORIGINS OF TRANSIENT OVERVOLTAGES

Transient overvoltages in power systems originate from one cause — energy being injected into the power system — but from two sources: lightning discharges or switching within the power system. In communication or data systems there is another source of transients: the coupling of power system transients into the system. Furthermore, all systems involving several connections to external equipment face the risk of transient overvoltages associated with ground potential rise during the flow of surge currents. As stated previously, static discharge problems are not treated in this report.

Lightning discharges may not necessarily mean direct termination of a lightning stroke onto the system. A lightning stroke terminating on some object near a power or data line will create a very fast-changing magnetic field that can induce voltages — and inject energy — into the loops formed by the conductors of the system. Lightning can also inject overvoltages in a system by raising the ground potential on the surface of the earth where the stroke terminates, while more distant "ground" points remain at a lower voltage, closer to the potential of "true earth." The literature provides information on the characteristics of lightning discharges.⁽¹⁻⁶⁾

Surges from power system switching create overvoltages as a result of trapped energy in loads being switched off, or of restrikes in the switchgear. These transients will be examined in greater detail in the following paragraphs.

2.1 Transients in power systems

A transient is created whenever a sudden change occurs in a power circuit, especially during power switching — either the closing or opening. It is important to recognize the difference between the intended switching (the mechanical action of the switch) and the actual happening in the circuit. During the closing sequence of a switch, the contacts may bounce, producing openings of the

circuit with reclosing by restrikes and reopening by clearing at the high-frequency current zero. Prestrikes can also occur just before the contacts close, with a succession of clearings at the high-frequency current zero, followed by restrikes. Similarly, during an opening sequence of a switch, restrikes can cause electrical closing(s) of the circuit.

Simple switching transients⁽⁷⁾ include circuit closing transients, transients initiated by the clearing of a short circuit, and transients produced when the two circuits on either side of the switch, being opened, oscillate at different frequencies. On the load side of the switch, for circuits having inductance and capacitance (all physical circuits have at least some, in the form of stray capacitance and inductance) with little damping, these simple switching transients are inherently limited to twice the peak amplitude of the steady-state sinusoidal voltage. On the load side of the switch and without a surge protective device, the current flowing just before switching is available to charge the circuit capacitances at whatever voltage is required to store the inductive energy of the current by converting it into capacitive energy; voltages can reach high levels, such as ten times the normal level.

Several mechanisms are encountered in practical power circuits that can produce large transient overvoltages. Two such mechanisms occur frequently: current chopping and restrikes, the latter being especially troublesome when capacitor switching is involved.

A similar scenario can unfold when an ungrounded power system experiences an arcing ground fault. The switching action is then not the result of a deliberate parting of contacts but the intermittent connection produced by the arc.

These switching overvoltages, high as they may be, are somewhat predictable and can be estimated with reasonable accuracy from the circuit parameters, once the mechanism involved has been identified.⁽⁸⁾ There is still some uncertainty as to *when* and *where* they occur because the worst offenders result from some abnormal, and thus rare,* behavior of a circuit element. Lightning-induced transients are much less predictable because there is a wide range of possibilities for the coupling mechanism.

* This rarity can take two different aspects: 1. In the vast majority of circuits, these abnormal transients can sometimes occur, but rarely ("when"). 2. Among all circuits, a few rare ones are frequently and consistently afflicted with such abnormal behavior ("where").

In response to these concerns, various committees and working groups have attempted to describe ranges of transient occurrences or maximum values occurring in power circuits. Three such attempts are described in the next section. Figures 1, 2, and 3 show typical examples of transients recorded in power systems.

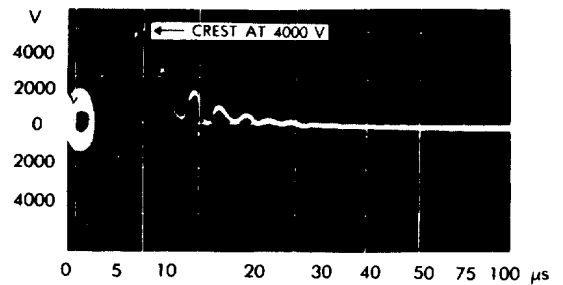

Figure 1. Lightning surge recorded on a 120 V overhead distribution system

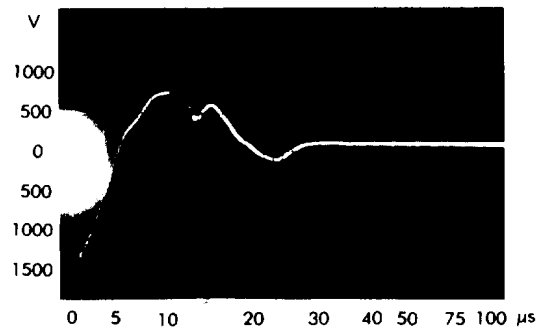

Figure 2. Switching surge recorded on a 120 V residential wiring system

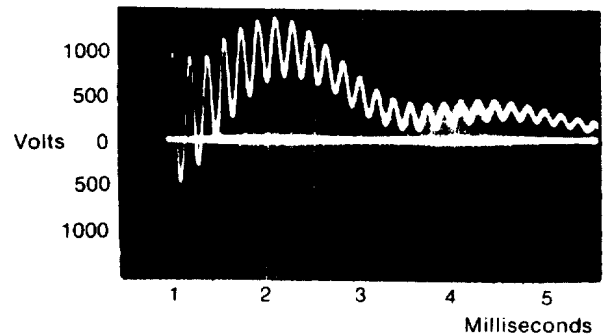

Figure 3. Capacitor switching transient recorded on a 460 V system

2.2 Transients in data lines

Data lines are different from power lines in the occurrence of surges: power systems can generate their own transients, as seen above, in addition to receiving injected surges. Data lines are only subjected to what the environment will inject. However, the operating voltages and the overvoltage tolerance of signal-processing components in these data systems are generally much lower than those of power system components. Thus, damage (not to discount problems of misoperation) is more likely to occur to data lines than to power system components from the same exposure to injected transients.

The systematic effort at characterizing surges in power circuits, exemplified by the IEEE standard described in the next section, has not been extensively reported by users of data lines, with the exception of the telephone industry.⁽⁹⁻¹³⁾ In the telephone environment, much emphasis is placed on lightning effects on long overhead or buried cables and lines, as well as on induced noise from adjacent power systems. The same IEEE group that produced the *Guide on surge voltages* is now addressing the lack of knowledge on data lines, such as interbuilding computer links and process control lines in chemical plants, which will be more relevant to computer users than are telephone environment data.⁽¹⁴⁾ Figures 4 and 5 show transients recorded on typical data lines exposed to lightning effects.

3. STANDARDS ON TRANSIENT OVERVOLTAGES IN POWER LINES

Several standards or guides have been issued or proposed in Europe and in the United States specifying a surge withstand capability for specific equipment or devices and specific conditions of transients in power or communication systems. Some of these specifications represent early attempts to recognize and deal with the problem in spite of insufficient data. As a growing number of organizations address the problem and as exchanges of information take place, improvements are being made in the approach. Three of these are briefly discussed here.

3.1 The IEEE Surge Withstand Capability Test (SWC)⁽¹⁵⁾

One of the earliest published documents which addressed new problems facing electronic equipment exposed to power system transients was prepared by an IEEE committee dealing with the exposure of power system relaying equipment to the harsh environment of high-voltage substations.



Figure 4. Transients induced by lightning in overhead data cable
Vertical: 4 V/div
Sweep: 1 ms/div
Cable: 1000 m long, 5 m high
(courtesy Digital Equipment Corporation)

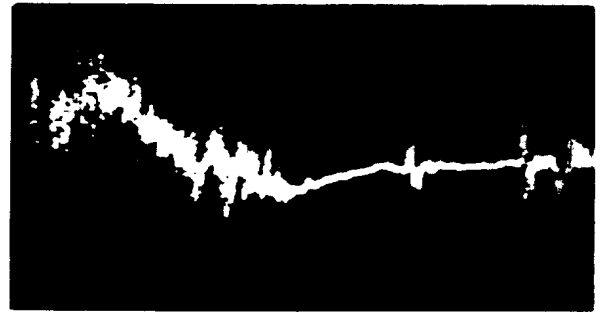

Figure 5. Surge and noise induced by lightning in overhead data cable
Peak: 48 V
Duration: 22 ms
Cable: 1000 m long, 15 m high
(courtesy Digital Equipment Corporation)

Because this useful document was released at a time when little other guidance was available, users attempted to apply the recommendations of this document to situations where the environment of a high-voltage substation did not exist. The revised version of this standard, soon to be issued, recognizes the problem and attempts to be more specific (and restrictive) in its scope. Thus, an important consideration in the writing and publishing of documents dealing with transients is a clear definition of the scope and limitations of the application.

Table 1
IEC Report 664
PREFERRED SERIES OF VALUES OF IMPULSE
WITHSTAND VOLTAGES FOR RATED VOLTAGES
BASED ON A CONTROLLED VOLTAGE SITUATION

| Voltages Line-to-Earth Derived from Rated System Voltages, Up to: | Preferred Series of Impulse Withstand Voltages in Installation Categories | | | |
|---|---|------|------|-------|
| | (V rms and dc) | I | II | III |
| 50 | 330 | 550 | 800 | 1500 |
| 100 | 500 | 800 | 1500 | 2500 |
| 150 | 800 | 1500 | 2500 | 4000 |
| 300 | 1500 | 2500 | 4000 | 6000 |
| 600 | 2500 | 4000 | 6000 | 8000 |
| 1000 | 4000 | 6000 | 8000 | 12000 |

3.2 The IEC 664 Report⁽¹⁶⁾

The Insulation Coordination Committee of the International Electrotechnical Commission (IEC) included in its report a table indicating the voltages that coordinated equipment must be capable of withstanding in various system voltages and installation categories (Table 1). The table specifies its applicability to a *controlled voltage situation*, which implies that some surge-limiting device has been provided — presumably a typical surge arrester with characteristics matching the system voltage in each case. The waveshape specified for these voltages is the 1.2/50 μ s wave,* a specification consistent with the insulation withstand concerns of the group that prepared the document. No source impedance is indicated, but four “installation categories”† are specified, each with decreasing voltage magnitude as the installation is farther away from the outdoor environment. Thus, this document primarily addresses the concerns of insulation coordination; the specification it implies for the environment is more the result of efforts toward coordinating the voltage levels than efforts to describe the environment and the occurrence of transients. The latter approach has been that of the IEEE Working Group on Surge Characterization in Low-Voltage Circuits, which will be reviewed in detail.

* The designation, 1.2/50 μ s, widely used in high-voltage dielectric tests, means a unidirectional impulse, double exponential, with 1.2 μ s rise time and 50 μ s to half-value on the decaying tail.

† The term “overvoltage categories” will replace “installation categories” in subsequent IEC recommendations.

3.3 The IEEE Guide on Surge Voltages (ANSI/IEEE Std C62.41-1980)⁽¹⁷⁾

3.3.1 Voltages and rate of occurrence

Data collected from a number of sources led to plotting a set of lines representing a rate of occurrence as a function of voltage for three types of exposures (Figure 6). These exposure levels are defined in general terms as follows:

- *Low Exposure* — Systems in geographical areas known for low lightning activity, with little load-switching activity.
- *Medium Exposure* — Systems in geographical areas known for high lightning activity, or with frequent and severe switching transients.
- *High Exposure* — Rare, but real, systems supplied by long overhead lines and subject to reflections at line ends, where the characteristics of the installation result in high sparkover levels of the clearances.

The two lower lines of Figure 6 have been drawn at the same slope because the data base shows reasonable agreement among several sources on that slope. All lines may be truncated by sparkover of the clearances, at levels depending on the withstand voltage of these clearances. The high exposure line needs to be recognized, but it should not be indiscriminately applied to all systems. Such application would penalize the vast majority of installations where the exposure is lower.

The voltage and current amplitudes presented in the *Guide* attempt to provide for the vast

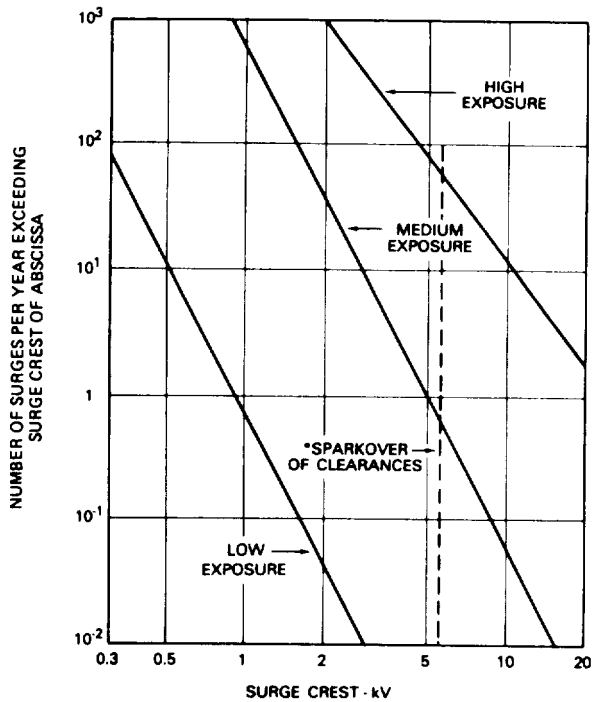

*In some locations, sparkover of clearances may limit the overvoltages

Figure 6. Frequency of occurrence vs level, from ANSI/IEEE C62.41-1980

majority of lightning strikes, but none should be considered "worst case," because this concept cannot be determined realistically. It is necessary to think in terms of the statistical distribution of strikes and to accept a reasonable upper limit for most cases. Where the consequences of a failure are not catastrophic but merely represent an annoying economic loss, it is appropriate to make a tradeoff of the cost of protection against the likelihood of a failure caused by a high but rare surge.

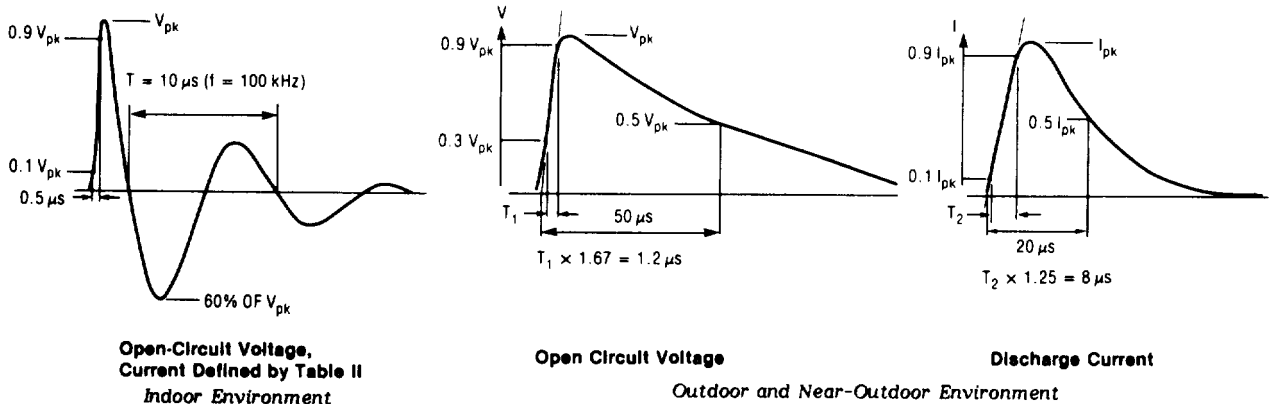

Figure 7. Surges defined for power lines by ANSI/IEEE C62.41-1980

3.3.2 Waveshape of the surges

Many independent observations⁽¹⁷⁻²¹⁾ have established that the most frequent type of transient overvoltage in ac power systems is a decaying oscillation, with frequencies between 5 and 500 kHz. This finding is in contrast to earlier attempts to specify the unidirectional double-exponential voltage wave that is generally described as 1.2/50. Indeed, the unidirectional voltage wave has a long history of successful application in the field of dielectric withstand tests and is representative of the surges propagating in power transmission systems exposed to lightning. In order to combine the merits of both waveshape definitions and to specify them where they are applicable, the *Guide* proposes two representative waveshapes: an oscillatory waveshape inside buildings, a unidirectional waveshape outside buildings, and both at the interface (Figure 7).

The oscillatory waveshape simulates those transients affecting devices that are sensitive to dv/dt and to voltage reversals during conduction,⁽²²⁾ while the unidirectional voltage and current waveshapes, based on long-established ANSI standards for secondary valve arresters, represent an equivalent of the transients where energy content is the significant parameter.*

* Recent concerns on the occurrence of longer duration surges, or lower frequencies, such as the 5 kHz lower limit cited, will probably be reflected in the updating of this standard over the next several years.

From a pragmatic point of view, the realization that oscillating waves are unavoidably produced by practical test systems²³ will also be a driving force toward specification of oscillatory waveforms rather than unidirectional impulses in future standards.

Increased recognition of the upset aspect of transient overvoltages is also likely to result in the inclusion of a "fast transient" with rise time and duration in the nanosecond range.

Table 2

(Reprinted by permission of the Institute of Electrical and Electronic Engineers, Inc.)

| Location Category | Comparable to IEC No 664 Category | Impulse | | Type of Specimen or Load Circuit | Energy (joules) Deposited in a Suppressor* with Clamping Voltage of | |
|---|-----------------------------------|---|---------------------------|--|---|----------------------|
| | | Waveform | Medium Exposure Amplitude | | 500V (120 V System) | 1000V (240 V System) |
| A Long branch Circuits and outlets | II | 0.5 μ s-100 kHz | 6 kV | High impedance [†] | — | — |
| | | | 200 A | Low impedance ^{†, §} | 0.8 | 1.6 |
| B Major feeders, short branch circuits, and load center | III | 1.2 \times 50 μ s 8 \times 20 μ s 0.5 μ s-100 kHz | 6 kV | High impedance [†] | — | — |
| | | | 3 kA | Low impedance [†] | 40 | 80 |
| | | | 6 kV 500 A | High impedance [†] Low impedance ^{†, §} | 2 | 4 |

*Other suppressors having different clamping voltages would receive different energy levels.

[†]For high-impedance test specimens or load circuits, the voltage shown represents the surge voltage. In making simulation tests, use that value for the open-circuit voltage of the test generator.

[‡]For low-impedance test specimens or load circuits, the current shown represents the discharge current of the surge (not the short-circuit current of the power system). In making simulation tests, use that current for the short-circuit current of the test generator.

[§]The maximum amplitude (200 or 500 A) is specified, but the exact waveform will be influenced by the load characteristics.

3.3.3 Energy and source impedance

The energy involved in the interaction of a power system with a surge source and a surge protective device will divide between the source and the protective device in accordance with the characteristics of the two impedances. With a gap-type protective device, the low impedance of the arc after sparkover forces most of the energy to be dissipated elsewhere: for instance, in a resistor added in series with the gap for limiting the power-follow[†] current, or in the impedance of the circuit upstream of the protective device. With an energy-absorber gapless protective device, a substantial share of the surge energy is dissipated in the suppressor, but its clamping action does not involve the power-follow energy resulting from the short-circuit action of a gap. It is therefore essential to the effective use of surge protective devices that a realistic assumption be made about the source impedance of the surge whose effects are to be duplicated.

Unfortunately, not enough data have been collected on what this assumption should be for the source impedance of the transient. Standards and recommendations, such as DOD STD-1399 or the IEC 664 report, either ignore the issue or indicate values applicable to limited cases, such as the SWC test for high-voltage substation equipment. ANSI/IEEE C62.41 attempts to relate impedance to categories of locations but unavoidably remains vague on their definitions (Table 2).

[†] Power-follow is defined in the IEEE Dictionary as "the current from the connected power source that flows through an arrester during and following the passage of discharge current."

Having defined the environment for low-voltage ac power circuits, the Working Group is now preparing an Application Guide, where a step-by-step approach will outline the method for assessing the need for transient protection and selecting the appropriate device or system. Parallel work in other IEEE working groups preparing test specification standards⁽²⁴⁻²⁷⁾ for surge protective devices will be helpful in this selection process. Other groups in the USA, as well as the international bodies of the IEC and the Comité Consultatif International Télégraphique et Téléphonique (CCITT), are now working toward further refinements and the reconciliation of different approaches.

3.4 Previous and future surge recordings

The supporting data cited in Appendix A of ANSI/IEEE C62.41 are based on voltage surge recordings made in the 1962-1975 period. In that period, digital instrumentation for surge monitoring was not as readily available as it is now, and, most significantly, the proliferation of surge protective devices, such as metal oxide varistors, had not reached the present level.

Measurements, limited to *voltage*, were conducted with oscilloscope/camera systems or with peak-recording instruments. Voltages were generally recorded between the line(s) and the neutral of a single-phase or polyphase power system. No measurements had been reported as neutral-to-ground; some may have been between line and ground. Of course, that distinction is moot for measurements made at the service entrance where neutral and ground are bonded.

Prior to the proliferation of varistors, a limitation had been recognized for peak voltages: the flashover of clearances, occurring typically between 2 and 8 kV for low-voltage wiring devices. For that reason, the curves of Figure 1 in the *Guide* include the indication of a possible truncation of the distribution around 6 kV. Recent studies, still in progress, have indicated that benign flashover of clearances, without power follow and therefore not readily detectable, may be more prevalent than was previously believed.

An estimate of the number of low-voltage surge protective devices such as varistors used in the United States since 1972 on ac power circuits is in the order of 500 million. An undefined but substantial portion of that number is installed in permanently connected equipment. Therefore, it is now very likely that a new limitation exists in the recording of voltage surges. A surge recording instrument installed indiscriminately at a random location may have a varistor connected across the line near the point being recorded.^{(28)*} This situation will have several implications for the recordings obtained in present and future measurements, as contrasted to those of previous measurement campaigns.

1. Locations where voltage surges were previously identified — assuming no change in the source of surges — are now likely to experience lower *voltage* surges, while *current* surges will occur in the newly installed protective devices.
2. Not only will the *peaks* of the observed voltages be changed, but also their waveforms will be affected by the presence of nearby varistors as follows:
 - a. If a varistor is located between the source of the surge and the recording instrument, the instrument will record the clamping voltage of the varistor. This voltage will have lower peaks but longer time to half-peak than the original surge.
 - b. If the instrument is located between the source of the surge and a varistor, or if a varistor is installed in a parallel branch circuit, the instrument will record the clamping voltage of the varistor, *preceded* by a spike corresponding to the inductive drop in the line supplying surge current into the varistor.
 - c. If a varistor is connected between line and neutral with a surge impinging

between line and neutral at the service entrance, a new situation is created: the line-to-neutral voltage is indeed clamped as intended, but the inductive drop in the neutral conductor between the point of connection of the varistor and the service entrance creates a spike voltage between the neutral and the grounding connector at the point of connection of the varistor and downstream points supplied by the same neutral. Because this spike will have a short duration, it will be enhanced by the open-end transmission line effect between the neutral and grounding conductors.^{(29)†}

3. The surge voltage limitation function performed by flashover of clearances is more likely to be assumed by new surge protective devices that are constantly being added to the systems.
4. The considerations discussed in paragraphs 1, 2, and 3 above will produce a significant reduction in the *mean* of recorded voltage surges in a population of different locations. This reduction will continue as more and more varistors are installed. The *upper limit*, however, will remain the same for locations where no varistor has yet been installed. A sense of false security and an incorrect description of the environment might be created by attention given only to the average of voltage surges presently recorded in power systems. Furthermore, the need for adequate surge current handling capability of a new candidate surge suppressor might be underestimated if partial surge diversion is already being performed by a nearby varistor. This risk will be exacerbated if an attempt is made to clamp at lower voltages by the installation of a new protective device with a clamping voltage lower than that of the device already installed.⁽⁸⁾

4. SURGE PROPAGATION

4.1 The limitations of arbitrary division into categories

The standards cited in the preceding paragraphs describe surges which may be expected at specific points of a wiring system; the implication is that the surges will proceed downstream, at the same amplitude and waveform, until some interface somehow produces a staircase-like decrease in

* See Case History No. 7 in Section 7 of this report.

† See an example of this situation in Section 6.5 of this report.

amplitude. IEC 664 proposes a voltage staircase with its overvoltage categories (Table 1), while ANSI/IEEE C62.41 proposes a current staircase with its location categories (Figure 8).

This staircase representation is useful to simplify the real world into a manageable set of assumptions, but it is a simplification that can mask the reality. Surges will propagate in the system starting at the point of entry; voltage surges will be attenuated to the extent that the series impedance between the point of interest and the source (Z_1 , Figure 9) on one hand and the shunt impedance (Z_2) on the other hand, form a voltage divider. If the series impedance is low and the shunt impedance is high (light loading of the system), the voltage divider does not produce high attenuation of the voltage surges. In addition to an attenuation of the amplitude, a waveform change takes place which is most apparent for fast front and short duration pulses.⁽²⁹⁾ Conversely, current surges, if they are the result of a current source such as a lightning strike, will produce high voltages unless a low-impedance diverting path is offered to the flow of current. If the current surge in a system is the result of a combined current source and multipath to ground (Figure 10), there is then a division of the current among the paths that is governed by the inverse ratio of the impedances. If a user has control over only one of the paths, he can decrease the amplitude of the current surge in his path only by forcing a greater share of the total current to flow through the other paths; thus, surge *blocking* is likely to be an exercise in passing the problem from one point of the system to another. The solution lies in surge *diversion*, offering to the surge a path where the current flow can occur harmlessly.

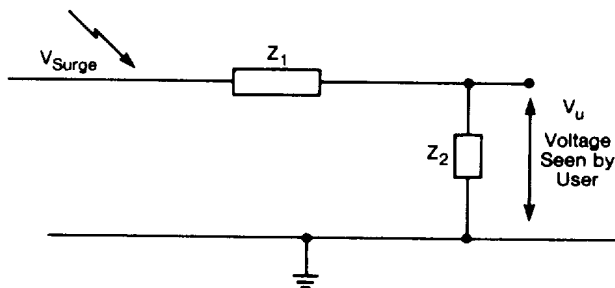

$$V_u = V_{\text{Surge}} \frac{Z_2}{Z_1 + Z_2}$$

Figure 9 Voltage divider effect

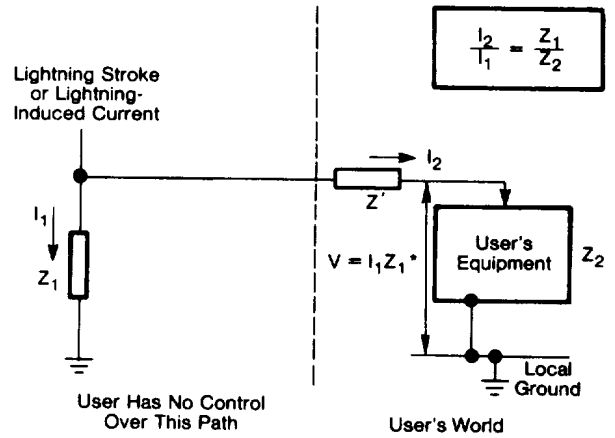

* or $V \approx I_1 Z_1 - I_2 Z'$ if Z' is Significant

Figure 10. Multipath current division

4.2 The limitations of transmission line analysis

In qualitative discussions of surge propagation, the classical behavior of a transmission line is often called upon to provide explanations of the situation. In particular, the reflections occurring at the end of a line are cited in accordance with the theory that the impulse is doubled if the line is open-ended, and that an inverse impulse is returned if the line is shorted. However, these discussions sometimes lose sight of the fact that the concept is applicable only if the line length is sufficient to contain all of the surge front. If the surge has a rise time longer than the propagation time along the line, the point is moot and, by the time the surge reaches its peak, the voltage at the receiving end of the line does not differ from the voltage applied at the sending end. Figure 11

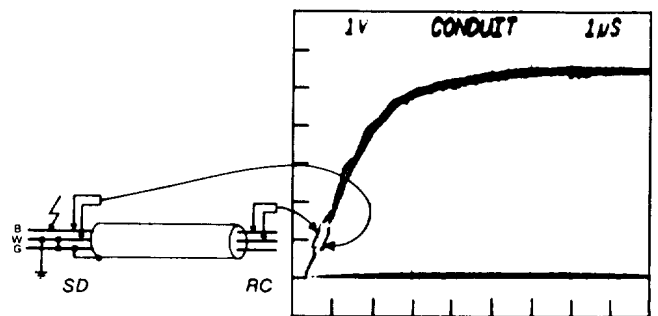
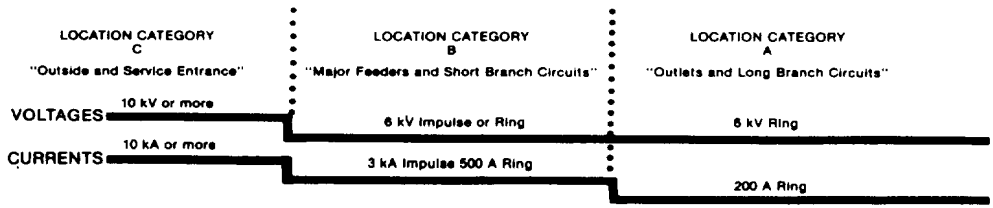

Figure 11. Voltages at sending end and receiving end of a line

- B: Black or phase conductor
- W: White or neutral conductor
- G: Green or grounding conductor

1. THE ANSI/IEEE STD C62.41 — 1980 CONCEPT OF LOCATION CATEGORIES IN UNPROTECTED CIRCUITS



2. TYPICAL EXAMPLES OF INDUSTRIAL OR RESIDENTIAL CIRCUITS

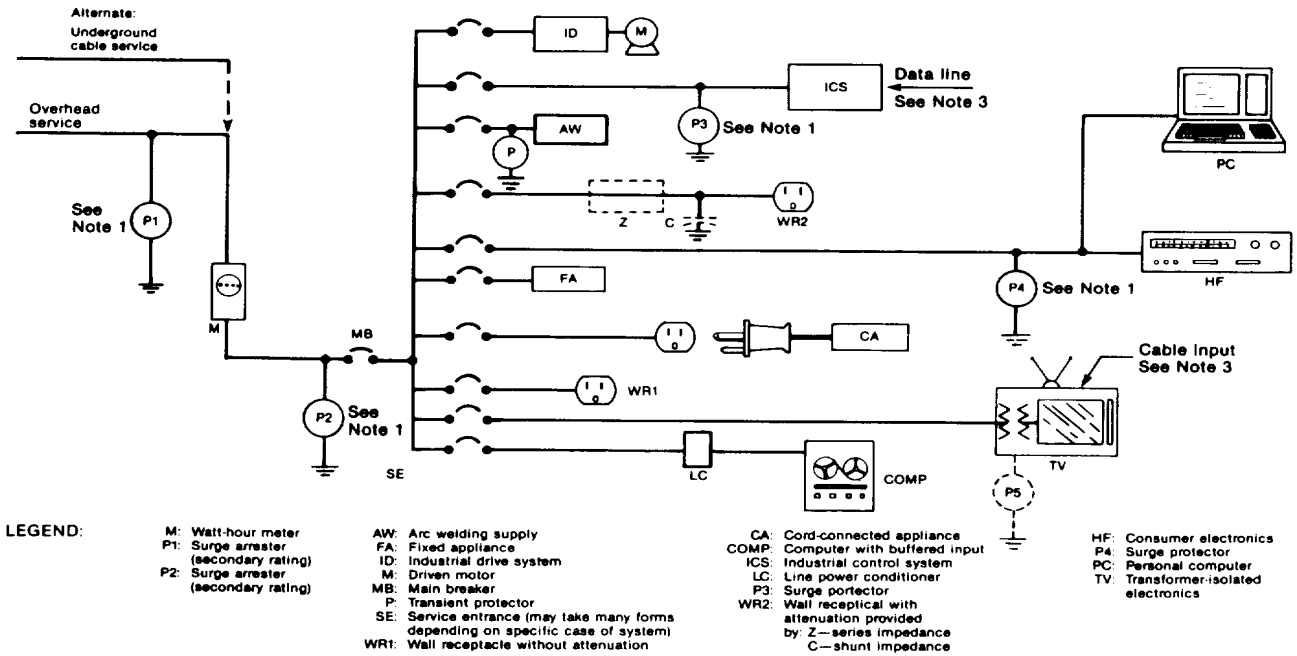

3. THE IEC REPORT 664—1980 CONCEPT OF CONTROLLED VOLTAGES

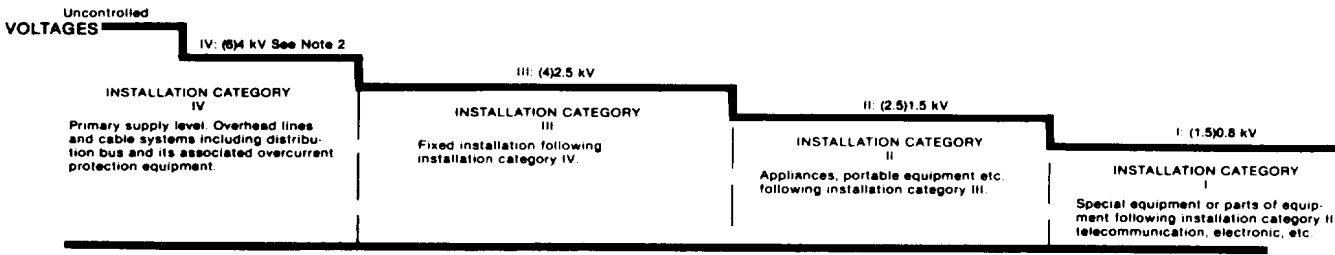

Independently from the location of a device or equipment in the above figure, it should remain safe (no fires, no personnel hazard) over the full range of available surges at any point within the installation. It may also be desirable, under particular circumstances and for specific devices, to proscribe damage as a result of testing at higher levels than might be suggested by its typical location.

Notes:

- (1) The Controlled Voltage Situation of IEC Report 664 requires the presence of interfaces; these can be surge protective devices such as P1, P2, P3 or P4, or the existence of well-defined impedance networks such as Z and C shown in the circuit diagram upstream of WR2.
- (2) Voltage levels following the designation of Installation Category (IV, III, II or I) are shown in parentheses for a system with 300 V phase-to-ground voltage, and next for 150 V phase-to-ground voltage. The voltages shown are implied as 1.2/50 μ s impulses.
- (3) This diagram makes no allowance for the possibility of surges associated with ground potential differences that may occur, for instance, with a sensor connection to the ICS control system, a cable TV connection to the line-isolated TV set, etc., or the flow of ground current in the impedance of the grounding conductors.

Figure 8. Similarities and differences between the location categories concept of ANSI/IEEE Std C62.41-1980 and the installation categories concept of IEC Report 664-1980, applied to a typical example

illustrates this situation showing the voltage at the sending end (SD) and the voltage at the receiving end (RC) of a conduit-enclosed three-wire line. There is a minor difference during the rise, where the initial front is doubled at the receiving end, but the final crest values are the same.

The effects of reflections and attenuations along a line are further illustrated in Figures 12, 13, and 14, excerpted from Reference 29. A three-wire, conduit-enclosed line, 225 m long was subjected to short pulses applied through an impedance-matching network to provide minimum interaction between the surge generator and the line. Access points at 75 and 150 m, in addition to the far end at 225 m, were provided within reach of the measuring oscilloscope probes by folding the line in a zig-zag configuration.

Figure 12 shows the propagation of a 200 ns-wide pulse when a matching impedance is connected at the receiving end. The attenuation of this pulse is quite apparent, with an average ratio of 0.7 between the voltages at points 75 m apart in the line. The travel time can also be seen as 1.1 μ s from sending to receiving and, corresponding to $225 \text{ m} / 1.1 \mu\text{s} = 204 \text{ m}/\mu\text{s}$, or two-thirds the speed of light in vacuum.

Figure 13 shows the same pulse propagating in the same line, but with a doubling of the voltage at the receiving end, which was left open. In spite of this doubling affect, there has been

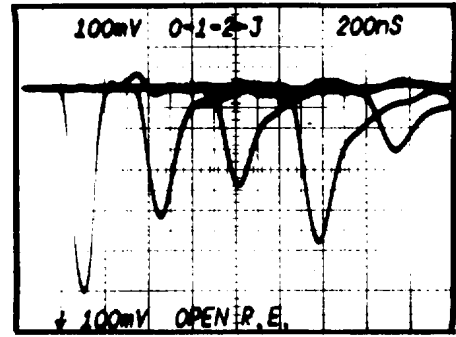

Figure 13. Propagation of the same pulse as Figure 12, with open-ended line

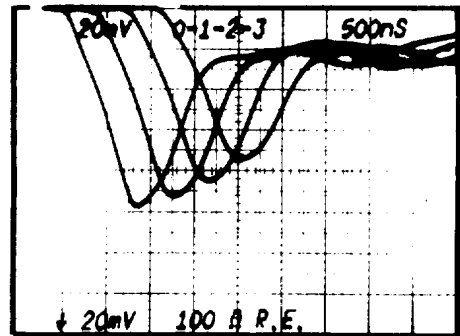

Figure 14. Propagation of a 2 μ s pulse in the line of Figure 12

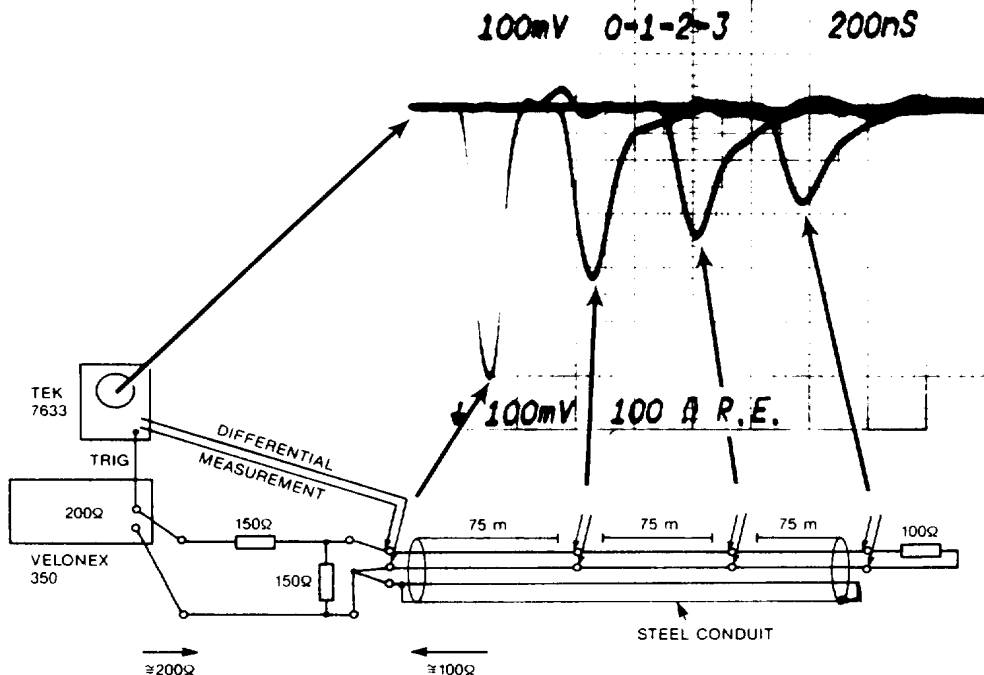

Figure 12. Propagation of a 200 ns-wide pulse in a line terminated by its matching impedance

enough attenuation of the short spike over the 225 m that the pulse at the receiving end is lower than the pulse at the sending end. However, for shorter lines, the attenuation would not have taken its toll before doubling at the end: doubling the pulse which appears at the *intermediate* 75 m of the 225 m line implies that, at the *end* of an open-ended 75 m, one could have a pulse 20% greater than at the sending end. Note also that, while the *amplitudes* are attenuated, the *rise time* tends to be increased; therefore, the time integral of the pulse (and therefore its potential for damaging energy-sensitive components) is not attenuated as quickly as is the amplitude along the line length.

Figure 14 shows a 2 μ s-wide pulse propagating along the same line, with matched termination. The attenuation is lower than for the 200 ns pulse, with an average ratio of 0.9 between the voltages of points 75 m apart in the line. This lower attenuation at longer pulse duration (lower frequencies) results from the decreased effect of the shunt capacitance of the line.

These propagation characteristics will be discussed again in conjunction with the performance of protective devices, in Section 6 of this report. Thus, for many installations contained in a building, the line lengths are short compared to the length required to contain, say, a 1 μ s front traveling at the speed of 200 m/ μ s. A more detailed report describing some of the aspects of the propagation of surges and their implications is given in References 29 and 30.

4.3 Common Mode or Normal Mode?

Another aspect of the propagation of surges concerns the dichotomy normal mode/common mode. In power lines, the issue is whether significant surges occur line-to-line (black-to-white, or phase-to-neutral), the situation described by "normal mode," or whether they occur between any — or all — of the lines and ground (black-to-green, white-to-green, or [black-and-white]-to-green), the situation described by "common mode." These terms were first defined in the context of signal lines, where the concern for balanced circuits reflects the fact that apparently innocuous common mode noise can be converted into objectionable normal mode when circuit impedances along the two signal-carrying wires are not symmetrical with respect to the ground (common) conductor (Figure 15).

Conversely, Figure 16 shows how an attempt to protect against a normal mode surge can produce a harmful common mode-like surge: at the

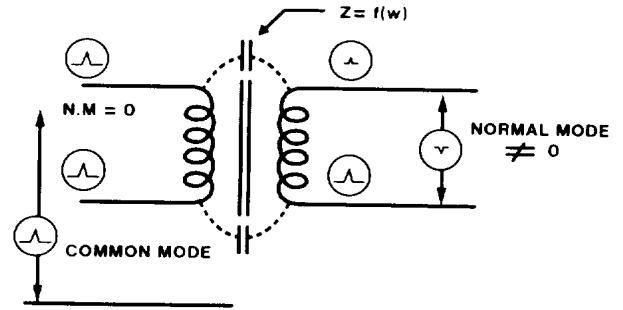

A. Common mode voltage on primary of transformer couples capacitively. Unequal impedances Z create normal mode voltage across secondary

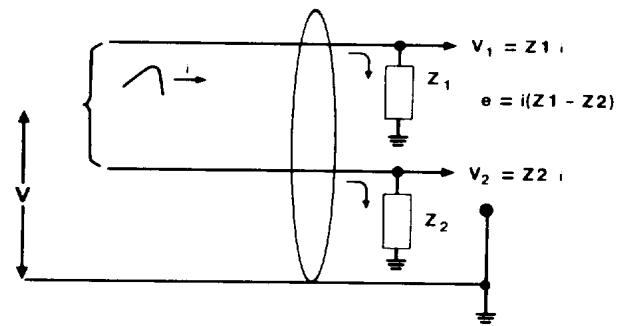

B. Current i flowing in the two lines of a data link, because of common mode voltage V , produce normal mode voltage e , even if currents are equal, when $Z1$ and $Z2$ are unequal

Figure 15. Conversion of a common mode surge into a normal mode surge

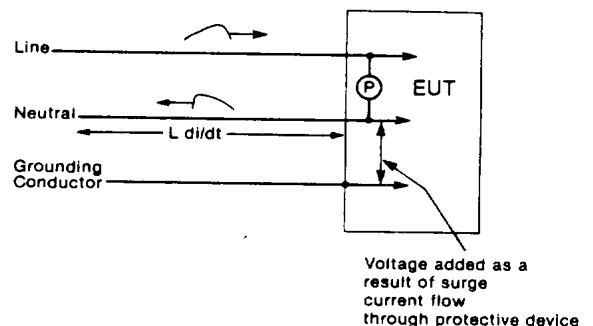

Figure 16. Current flowing in line-to-neutral protective device causes voltage to appear between neutral and grounding conductors

end of a branch circuit, the user installs a surge-protective device connected line-to-neutral, in order to protect his load equipment against a normal mode surge impinging the origin of the branch circuit, where the user in this assumed scenario has no access to provide a surge protective device. Common knowledge that the neutral and grounding conductors are bonded at this origin might lead the user to believe that no harmful voltage can occur at his end between neutral and grounding conductors. Yet, the very installation of the protective device between line and neutral, results in a significant $L di/dt$ voltage developed along both line and neutral conductors when the surge current flows into the protective device; half of the total voltage appears at the user's end between the neutral and the grounding conductors. Because there is generally no admittance between the neutral and grounding conductors at the user's end, the situation is then that of an open-ended line, which produces a doubling of the impinging neutral-to-ground voltage. An example of this situation is discussed in Section 6.5.

Thus, the answer to the normal/common mode dichotomy is that, in most cases, both modes must be considered, because one can convert into the other, depending upon the coupling, the wiring practices, and the attempts made at suppressing the mode perceived as the greatest threat. Here again, the pervasive and pervert reality is too often that a solution aimed at suppressing one effect only displaces the problem. Case History No. 5, later in this report, shows quantitative measurement results of the effects of various methods of connecting a surge protective device at the end of a line.

5. FUNDAMENTAL PROTECTION TECHNIQUES

The protection of a power system, a computer system, or an electronic black box against the threats of the surge environment can be accomplished in different ways. There is no single truth or magic cure ensuring immunity and success, but, rather, there are a number of effective approaches that can be combined as necessary to achieve the goal. The competent protection engineer can contribute his knowledge and perception to the choice of approaches against a threat that is imprecise and unpredictable, keeping in mind the balance between the technical goal of maximum protection and the economic goal of realistic protection at an acceptable cost. However, just as in the case of accident insurance, the cost of the premium appears high before the accident, not after.

A discussion of fundamental protection techniques that is limited in space and scope has the risk of becoming an inventory of a bag of tricks; yet, there are a few fundamental principles and fundamental techniques that can be useful in obtaining transient immunity, especially at the design stages of a computer system or circuit. All too often, the need for protection becomes apparent at a late stage, when it is much more difficult to apply those fundamental techniques which are most effective and economical when implemented at the outset.

5.1 Basic techniques

Protection techniques can be classified into several categories according to the purpose and the system level at which the engineer is working. For the system as a whole, protection is primarily a preventive effort. One must consider the physical exposure to transients — in particular, the indirect effects of lightning and power system faults resulting from building design, location, physical spread, and coupling to other disturbance sources — as well as such inherent susceptibility characteristics as frequency response and nominal voltage. A data processing system using low-voltage signals, high-impedance circuits, and installed over a wide area such as a chemical plant spread over several kilometers, would present much more serious problems than the same system confined to a single building. As discussed in Case History No. 1, the installation of remote terminals in separate buildings is a prime candidate for trouble unless some basic precautions are observed.

For the system components or electronic black boxes, the environment is often beyond the control of the designer or user, and protection becomes a curative effort — learning to live and survive in an environment which is imposed. Quite often this effort is motivated by field failures, and retrofit is needed. The techniques involved here tend to be the application of protective devices to circuits or a search for inherent immunity rather than the elimination or diversion of surges at their origin.

Another distinction can be made in classifying protective techniques. While surges are unavoidable, one can attempt to block them, divert them, or strive to withstand them; the latter, however, is generally difficult to achieve alone.

5.2 Shielding, Bonding, and Grounding

Shielding, bonding, and grounding are three interrelated methods for protecting a circuit from external transients. Shielding is the practice of

enclosing the circuit components in a conductive enclosure, which theoretically cancels out any electromagnetic field inside the enclosure; actually, it is more an attenuation than a cancellation because the enclosure is rarely complete and perfect. Bonding is the practice of providing low-impedance connections between adjacent metal parts, such as the panels of a shield, cabinets in an electronic rack, or rebars in a concrete structure. Grounding is the practice of providing a low impedance to earth or a well-defined reference ultimately connected to earth,* through various methods of driving conductors into the soil. Each of these techniques has its limitations, and each can sometimes be overemphasized.

5.3 Shielding

Shielding conductors by wrapping them in a grounded sheath or shielding an electronic circuit by enclosing it in a grounded conductive box is a defensive measure that occurs very naturally to the system designer or the laboratory experimenter anticipating a hostile electromagnetic environment. Difficulties arise, however, when the concept of "grounded" is examined in detail. Difficulties also arise when the goals of shielding for noise immunity conflict with the goals of shielding for surge immunity.

A shield can be the size of a matchbox or an airplane fuselage; it can cover a few centimeters of wire or kilometers of buried or overhead cables. Effective grounding of these diverse shields is not always an easy thing to do because the impedance to earth of the grounding connection must be acknowledged. The situation is made even more controversial because of the conflict between the often-proclaimed design rule "ground cable shields at one end only" — a rule justified by noise immunity performance, in particular common mode noise reduction — and the harsh reality of current flow and Ohm's law when lightning strikes or when power systems faults occur.

The difficulty may be caused by a perception on the part of the noise prevention designers that the shield serves as an electrostatic shield in which longitudinal currents associated with common mode noise coupling should not flow. This con-

cept is exemplified in the terminology of shielded cable users, when they describe the shield construction of some cable design as having a foil plus "drain wire," as if there were *electrostatic* charges that needed to be removed (*drained*). Indeed, electrostatic charges can be drained by connecting only one end of the shield. Furthermore, if the two ends of the shield of a cable spanning some distance are connected to the local ground at each end, there is a definite possibility that some power frequency current may flow in the shield. For low-level signals, this current could produce noise (hum) in the signals. For that reason, many system designers will insist on the one-end-only grounding rule, and they are correct from that point of view. Sometimes the shield is used as a return path for the signal circuit, in which case shield currents will cause voltage drops added to the signal. But the fact is that, when *surge* currents flow near the circuits, they will unavoidably inject magnetic flux variations into the circuits; hence induced voltages. Worse yet, in the case of a lightning stroke or of a power system fault injecting current into the earth in the area spanned by the one-end-only grounded shield, the potential of one end of the cable defined as "ground" is not the same as the "ground" at the other end of the cable. Very high voltages can be developed (Figure 17) between the floating end of the shield and the local ground. No practical insulation can withstand these levels, and breakdown will occur, allowing surge currents to flow in spite of the designers' intent to prevent them. The path of these currents will be determined by the components most likely to fail when the voltage rises — the low-level logic circuits, of course. In contrast, by deliberately allowing a small part of these surge currents to flow in the shields, one obtains a cancellation of the voltages that

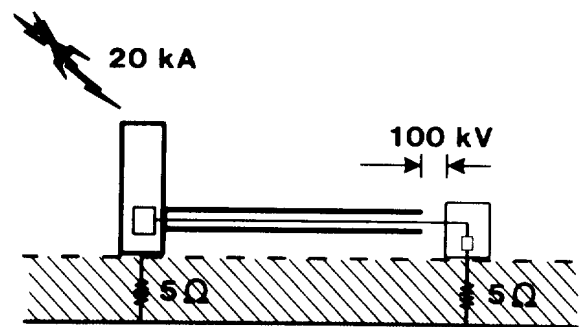

Figure 17. Voltage developed by a lightning stroke at the ungrounded end of a shield

* Connection of the reference to earth is a general safety requirement involving low frequency fault currents for which adequate low-impedance connection is a matter of conductor resistance. At the high frequencies involved with transient disturbances, the inductance of the connection becomes significant. See detailed discussion in paragraph 5.5.

otherwise would be induced in the circuits, and the currents will follow a well-defined path that can be designed to produce harmless effects.

This conflict is actually very simple to resolve if recognized in time: provide an outer shield, grounded at both ends (and at any possible intermediate points); inside this shield the electronic designer is then free to enforce his single-point grounding rules. The only drawback to this approach is the hardware cost of double shields. In many installations, however, there is a metallic conduit through which the cables are pulled; with simple but close attention to maintaining the continuity of this conduit path, through all the joints and junction boxes, a very effective outer shield is obtained at negligible additional cost. In the case of underground conduit runs, the most frequent practice is to use plastic conduit, which unfortunately breaks the continuity. System designers would be well advised to require metal conduits where the circuits are sensitive or, at a minimum, to pull a shielded cable in the plastic conduit where the shield is used to maintain continuity between the above-ground metal conduits. That additional cost, then, is the insurance premium, which is well worth accepting. Case History No. 1, given later in this report, illustrates the penalty inflicted by nature when the one-and-only-one-ground rule was misapplied by the designer.

5.4 Bonding

We have already mentioned one aspect of bonding in describing the continuity of the outer shield. Another instance of bonding occurs where the shield of an incoming cable is connected to an equipment cabinet in order to allow shield current flow. The shield current flows in the connecting pigtail and creates electromagnetic radiation at the point of cable entry.

Adjacent cabinets in a lineup must be bonded together for safety as well as transient and noise immunity. In principle, a flat strap has a lower inductance than a round wire of the same area. This concept may be somewhat overused; actually several strategically located smaller wires provide a much more effective bond than one massive strap, either round or flat. The difficulty lies in implementing this alternate view, and overcoming the comforting sight of a large grounding strap at the bottom of the cabinet lineup. Such a strap does no harm and is a good safety practice, but it may not do as much good as expected from the point of view of surge protection, compared to multiple point bonds.

A significant subset of the general subject of bonding is the termination of cable shields by

connectors at the junction to an equipment cabinet. The search for low-cost construction often results in the shield being connected through one pin of the multiple-pin connector. Add to this construction the misguided concept that all grounding connections in a cabinet should be made to a single point, and the result will be the worst possible practice, as shown in Figure 18A: the shield current is injected inside the cabinet along a tortuous path, creating interference in all circuits. Figure 18B shows a tolerable practice, where the connection is still made through the connector, for convenience, but a very short lead makes the connection to the cabinet frame inside the cabinet. Figure 18C shows an improvement, with the connection made outside the cabinet. A variation of this arrangement is encountered in RS232 connectors with a metal shell where the two securing screws provide a double (and symmetrical) bond to the equipment chassis. The ultimate and best bond, of course, is obtained by using a connector with a continuous bond provided by a cable connector with metallic shell and ring screwed to the chassis connector all around the cable (Figure 18D).

5.5 Grounding

Grounding, or earthing, has different meanings as well as different roles. The primary definition is the connection of the circuit, shield, or reference to *earth*. But what is earth? System designers, construction crews, inspectors, and technical conference authors are concerned with establishing, measuring, and maintaining a low ground *resistance*, often determined by dc measurements on rods driven into the ground. Driving many rods into the ground at great expense does not ensure a low *impedance* under the transient conditions of a high rate of current change associated with lightning discharges.

When one deals with a reasonably compact system, be it cabinet-size, room-size, or building-size, it is more effective to view the grounding as a well-bonded connection to the outer shield (if any), building frame, or cabinet enclosure, acting as a zero-reference. The resistance (impedance) from that reference to earth is not very significant as long as other wires at ground potential are not brought to the system. Since there is little chance of dealing with an absolutely isolated system (short of a flying aircraft, which does quite well, thank you, without an *earth* connection), the question is: What should be done with incoming wires? These wires can be isolated from the local ground during normal operation, but one must recognize that, during transient conditions of

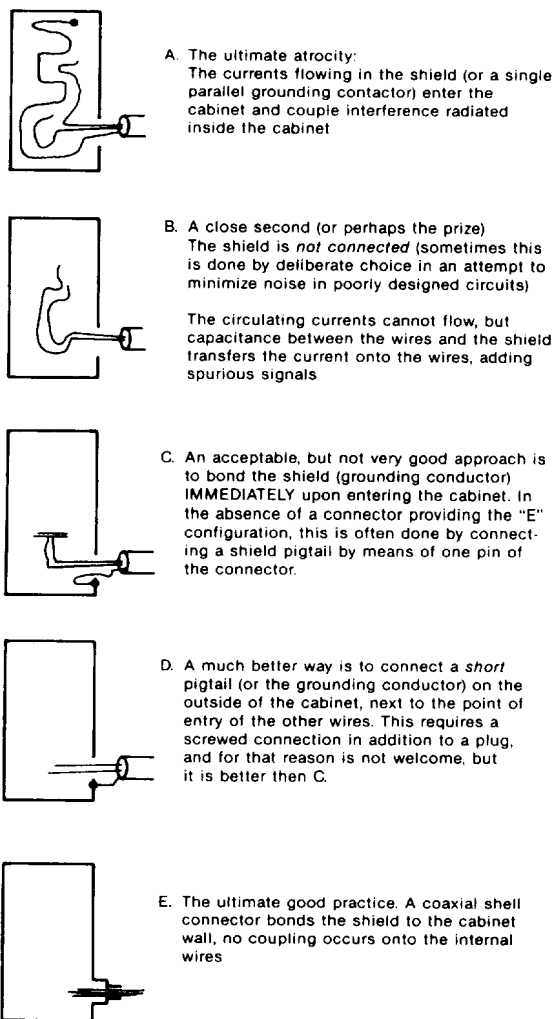

Figure 18. Bonding of cable shields to equipment cabinets

lightning surges or power system faults, high voltages will appear across these isolated wires and local ground — voltages which, in some cases, are far beyond the withstand capability of insulation. That insulation, then, must be protected by suitable devices which, in fact, do connect the wires to the local ground, but only for the duration of the transient. This type of momentary grounding is one function of transient suppressors.

An effective approach to limiting the adverse effects of ground potential differences is the enforcement of a "ground window"* arrangement

* The concept and the term "ground window" were developed by workers in the Bell System; the author was introduced to the concept by Paul Speranza of Bell Communications Research during discussions at IEEE working group meetings; this sharing of information is gratefully acknowledged.

of *all* conductors entering a system, as shown in Figure 19. The system can be a single cabinet, room-size equipment, or a complete floor in a building — the principle remains the same. This ground window must be specified from the beginning, as retrofits are generally difficult to make.

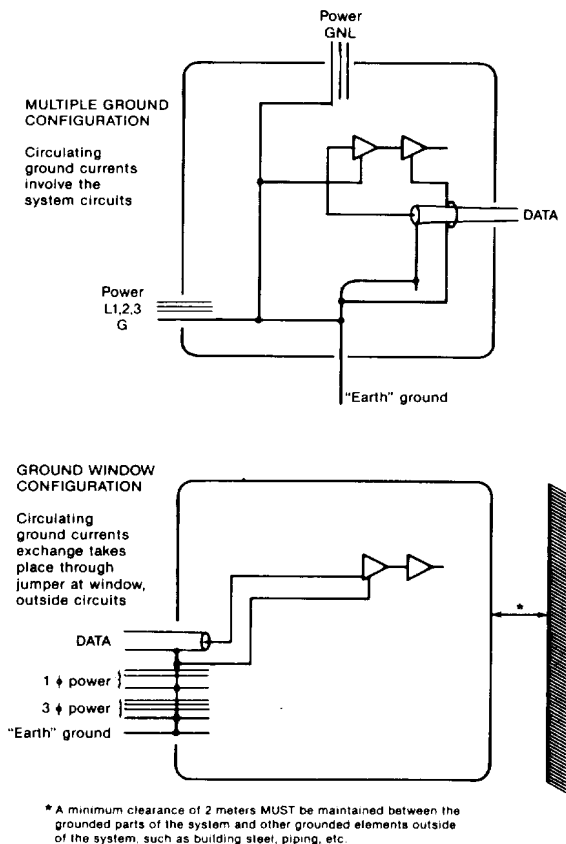

Figure 19. Multiple cable entry vs single ground window

5.6 Isolation of subsystems

In the case of systems involving separate buildings, remote sensors, or the interconnection of a power system with a communication system, other requirements may dictate the isolation of the subsystems, creating the illusion that protection against overvoltages has also been accomplished. And yet we have seen that during transient conditions high voltages can occur between the subsystems.

Where moderately high voltages only can occur, effective isolation can be accomplished by the insertion of an isolating transformer or an opto-isolator; if metallic isolation is not required, a filter can also be used if it does not degrade data pulse shapes or system frequency response.

Where the voltages will reach levels exceeding the withstand capability of economically or technically feasible insulation, two possible solutions exist. The first, already mentioned, and applicable to power as well as data systems, is to bond the grounds or references of the two systems during the transient by means of a surge protective device, which returns to a high level of insulation after the transient has subsided. The second, applicable only to low-power data transmission, is to use other methods, such as insertion of audio couplers or a fiber optics link. Complete decoupling of electrical transients and noise resulting from ground potential differences can be achieved in this manner; however, these techniques will not guard against noise collected by the circuits themselves and faithfully transmitted by the link to the other end.

6. TRANSIENT SUPPRESSORS

Various devices have been developed for protecting electrical and electronic equipment against transients. They are often called "transient suppressors" although, for accuracy, they should be called "transient limiters," "clamps," or "diverters" because they cannot really suppress transients; rather, they limit transients to acceptable levels or make them harmless by diverting them to ground around the sensitive equipment.

There are two categories of transient suppressors: those that block transients, preventing their propagation toward sensitive circuits, and those that divert transients, limiting voltages to an acceptable residual level. Because many of the transients originate from a current source, the blocking of a transient may not always be possible; thus, diverting the transient is more likely to find general application. A combination of diverting and blocking can be a very effective approach. This approach generally takes the form of a multistage circuit, where a first device diverts the transient toward ground, a second device — an impedance or resistance — offers a restricted path to the transient propagation but an acceptable path to the signal or power, and a third device clamps the residual transient (Figure 20). Thus, we are primarily interested in the diverting devices. These diverting devices can be of two kinds: voltage-clamping devices or short-circuiting devices (crowbar). Both involve some nonlinearity, either frequency nonlinearity (as in filters) or, more usually, voltage nonlinearity. Depending on the type of device, this voltage nonlinearity is the result of two different mechanisms — a continuous increase

in the device conductivity as the current increases, or an abrupt switching as the voltage increases.

Because the technical and trade literature contains many articles on these devices, a discussion of the details will be limited and review of the references is suggested. Some comparisons will be made, however, to point out the significant differences in performance; clarification of some issues resulting from unwarranted concern will also be given. We will first examine the basic principles of single-component suppressors, then the application of these devices to protect circuits, as single- or multiple-component packaged devices.

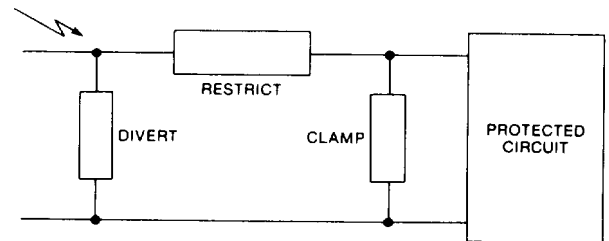

Figure 20. Hybrid approach for surge suppression

6.1 Crowbar devices

The principle of crowbar devices is simple: upon occurrence of an overvoltage, the device changes from its normal high-impedance state to a low-impedance state, offering a low-impedance path to divert the surge to ground. This switching can be inherent to the device, as in the case of spark gaps involving the breakdown of a gas or the recently introduced two-terminal multijunction semiconductors. Some applications have also been made of externally triggered devices, such as triggered vacuum gaps in high-voltage technology or thyristors in low-voltage circuits, where a control circuit senses the rising voltage and turns on the surge-rated device to divert the surge.

The major advantage of the crowbar device is that its low impedance allows the flow of substantial surge currents without dissipation of high energy within the device itself; the energy has to be spent elsewhere in the circuit. This so-called "reflection" of the impinging surge can also be a disadvantage in some circuits when the transient disturbance associated with the gap firing is being considered. Where there is no problem of power-follow (discussed below), such as in communication circuits, the spark gap has the advantage of very simple construction with potentially low cost.

The crowbar device, however, has three major limitations. The first limitation concerns the voltage-time sensitivity of the breakdown process. As the

voltage increases across a spark gap, a significant conduction of current — and hence the voltage limitation of a surge — cannot take place until the transition occurs to the arc mode of conduction, by avalanche breakdown of the gas between the electrodes. The load is left unprotected during the initial rise because of this delay time (typically in microseconds). Considerable variation exists in the sparkover voltage achieved in successive operations, because the process is statistical in nature. In addition, this sparkover voltage can be substantially higher after a long period of rest than after successive discharges. From the physical nature of the process, it is difficult to produce consistent sparkover voltage for low-voltage ratings. This difficulty is increased by the effect of manufacturing tolerances on very small gap distances, but it can be alleviated by filling the tube with a gas having a lower breakdown voltage than air. However, if the enclosure seal is lost and the gas is replaced by air, this substitution creates a reliability problem due to the substantially higher sparkover of the air gap.

In communication circuits using a pair of conductors, protection is often provided by connecting a gas tube between each conductor and ground. Upon occurrence of a common mode surge, which would leave the input circuits unaffected, an nature of the process, it is difficult to produce consistent sparkover voltage for low-voltage ratings. This difficulty is increased by the effect of manufacturing tolerances on very small gap distances, but it can be alleviated by filling the tube with a gas having a lower breakdown voltage than air. However, if the enclosure seal is lost and the gas is replaced by air, this substitution creates a reliability problem due to the substantially higher sparkover of the air gap.

In communication circuits using a pair of conductors, protection is often provided by connecting a gas tube between each conductor and ground. Upon occurrence of a common mode surge, which would leave the input circuits unaffected, an undesirable condition results from the volt-time variation between the two devices: unavoidable manufacturing tolerances between the two devices, plus the statistical variation for each tube breakdown cause one tube to fire before the other. During the time separating the two firings, a substantial *normal* surge is applied to the input circuitry, with possible destructive effects (Figure 21). This problem can be avoided by using three-electrode tubes where firing of the first gap causes firing of the second gap with no delay (Figure 22).

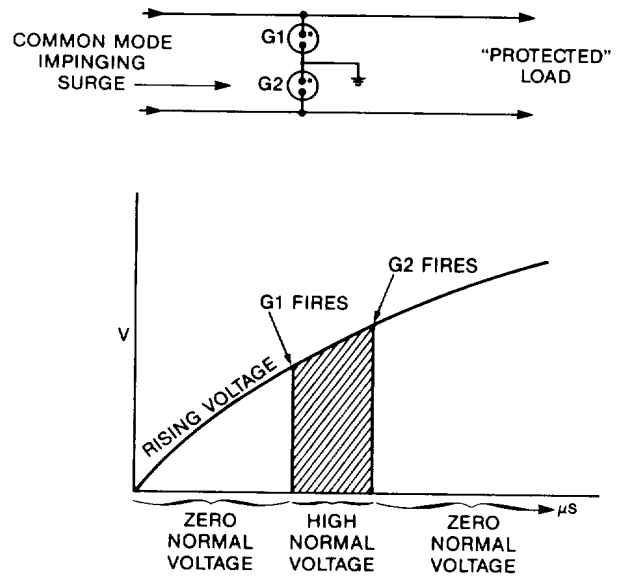

Figure 21. Normal mode surge resulting from difference of sparkover time of two separate gas tubes

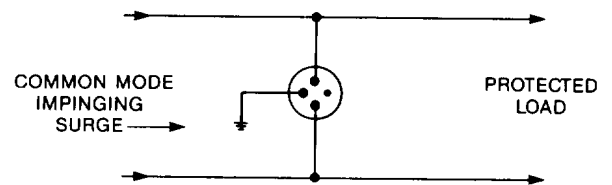

Figure 22. Three-electrode gas tube avoiding the problem of Figure 21

The second limitation is associated with the sharpness of the sparkover, which produces fast current rises in the circuits and, thus, objectionable noise. A classic illustration of this problem is found in oscillograms recording the sparkover of a gap where the trace exhibits an anomaly *before* the sparkover (Figure 23). This anomaly is due to the delay introduced into the oscilloscope circuits to provide an advanced trigger of the sweep.

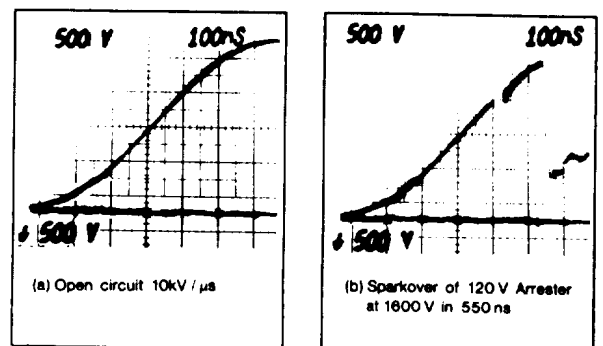

Figure 23. Anomaly in recording showing gap interference

What the trace actually shows is the event delayed by a few nanoseconds, so that in real time, the gap sparkover occurs and noise enters the oscilloscope by stray coupling, while the electron beam is still writing the pre-sparkover rise. Another, more objectionable, effect of this fast current change can be found in some hybrid protective systems. The circuit of one such commercial device is shown in Figure 24. The gap does a very nice job of discharging the impinging high-energy surges, but the magnetic field associated with the high di/dt induces a voltage in the loop adjacent to the second suppressor, adding what can be a substantial spike to the expected clamping voltage provided by the second device. An illustration of this effect is discussed in Case History No. 1.

A third limitation occurs when a power current from the steady-state voltage source follows the surge discharge (follow-current or power-follow). In ac circuits, this power-follow current may or may not be cleared at a natural current zero. In dc circuits, clearing is even more uncertain. Additional means, therefore, must be provided to open the power circuit if the crowbar device is not designed to provide self-clearing action within specified limits of surge energy, system voltage, and power-follow current. This combination of a gap with a current-limiting, nonlinear varistor has been very successful in the utility industry as a surge arrester, often referred to as a "valve-type arrester."

6.2 Voltage-clamping devices

Voltage-clamping devices exhibit a variable impedance, depending on the current flowing through the device or the voltage across its terminals. These components show a nonlinear characteristic — that is, Ohm's law can be applied, but the equation has a variable R . Impedance variation is monotonic and does not contain discontinuities, in contrast to the crowbar device, which shows a discontinuity by turn-on action. As far as volt-ampere characteristics are concerned, these components are time-dependent to a certain

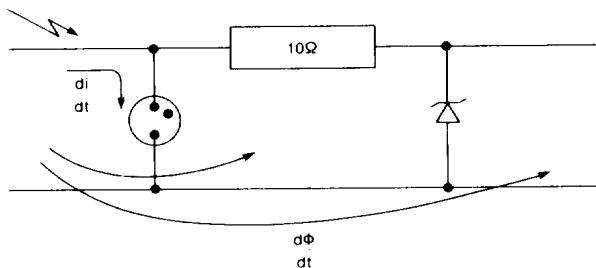

Figure 24. Typical hybrid circuit subject to induced voltage

degree. However, unlike the sparkover of a gap or the triggering of a thyristor, time delay is not involved.

When a voltage-clamping device is installed in a circuit, the circuit remains essentially unaffected by the device before and after the transient for any voltage below clamping level. Increased current drawn through the device as a surge voltage attempts to rise results in voltage-clamping action. Nonlinear impedance means that this current increases more than the voltage. The increased voltage drop (IR) in the source impedance due to higher current results in the apparent clamping of the voltage. It should be emphasized that the device depends on the source impedance to produce clamping. A voltage divider action is at work where the ratio of the divider is not constant, but changing. If the source impedance were very low, the ratio would be low, and eventually the suppressor could not work at all with a zero source impedance (Figure 25). In contrast, a crowbar type of device effectively short circuits the transient to ground; once established, however, this short circuit will continue until the current (the surge current as well as any power-follow current supplied by the power system) is brought to a low level.

The principle of voltage clamping can be achieved with any device exhibiting this nonlinear impedance. Two categories of devices, having the same effect but operating on very different physical processes, have found acceptance in the industry: polycrystalline varistors and single-junction avalanche diodes. Another technology, selenium rectifiers, has been practically eliminated from the field because of the improved characteristics of modern varistors.

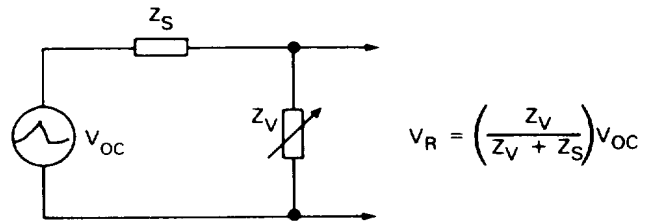

Figure 25. Voltage divider effect of shunt-connected suppressor

6.3 Avalanche diodes

Avalanche diodes, or Zener diodes, were initially applied as voltage clamps, a natural outgrowth of their application as voltage regulators. Improved construction, specifically aimed at surge absorption, has made these diodes very effective suppressors. Large-diameter junctions and low

thermal impedance connections are used to deal with the inherent problem of dissipating the heat deposited by the surge in the small volume of a very thin single-layer junction.

The advantage of the avalanche diode, generally a P-N silicon junction, is the possibility of achieving low clamping voltage and a nearly flat volt-ampere characteristic over its useful power range. Therefore, these diodes are widely used in low-voltage electronic circuits for the protection of 5 V or 15 V logic circuits, for instance. For higher voltages, the heat generation problem associated with single junctions can be overcome by stacking a number of lower voltage junctions, admittedly at some extra cost.

Silicon avalanche diodes are available with characteristics tailored to transient suppression. These should not be confused with regulator-type Zener diodes although many engineers tend to use the generic term "Zener diode." May Zeus help them if they misapply a regulator-type Zener, expecting to achieve good protection!

Since the junction is very thin, the capacitance of an avalanche diode is appreciable. This can be a concern. The effect of capacitance can be minimized by using series combinations with low-capacitance diodes (Figure 26).

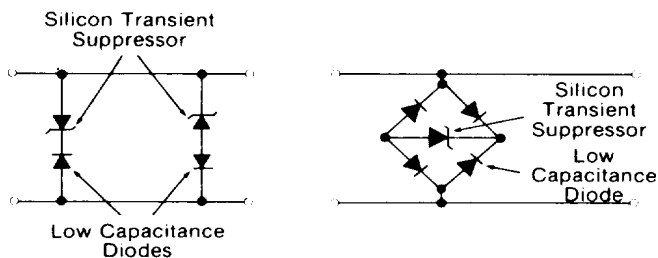

Figure 26. Reduction of effective capacitance of a suppressor

6.4 Varistors

The term *varistor* is derived from the function of the device as *variable resistor*. This device has also been called a *voltage-dependent resistor*, but that description tends to imply that *voltage* is the independent parameter in surge protection, while in fact surge *current* is the given parameter. Two very different devices have been successfully developed as varistors: silicon carbide blocks have been used for years in the surge arrester industry, and more recently, metal oxide varistors have become widely used.

Metal oxide varistors depend on the conduction process occurring at the boundaries between grains of oxide (typically zinc oxide) grown in a carefully

controlled sintering process. The physics of the nonlinear conduction mechanism have been described in the literature.⁽³¹⁻³⁵⁾

Because the prime function of a varistor is to provide the nonlinear effect, other parameters are generally the result of tradeoffs in design and inherent characteristics. The electrical behavior of a varistor can be understood by examination of the equivalent circuit of Figure 27. The major element is the varistor proper, R_v , whose $V-I$ characteristic is assumed to be the perfect power law, $I = kV^\alpha$. In parallel with this varistor, there is a capacitor, C , and a leakage resistance, R_p . In series with this three-component group, there is the bulk resistance of the zinc oxide grains, R_s , and the inductance of the leads, L .

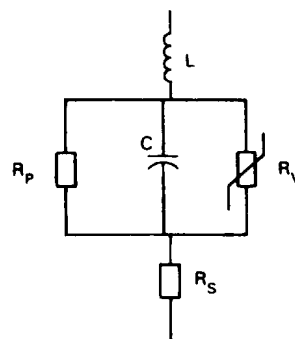

Figure 27. Equivalent circuit of a varistor

Under dc conditions (at low-current densities because obviously no varistor could stand the high energy deposited by dc currents of high density), only the varistor element and the parallel leakage resistance are significant. Under pulse conditions at high-current densities, all but the leakage resistance are significant: the varistor provides low impedance to the flow of current, but eventually the series resistance will produce an upturn in the $V-I$ characteristic; the lead inductance can give rise to spurious overshoot problems if not dealt with properly; and the capacitance can offer either a welcome additional path for fast transients or an objectionable loading at high frequency, depending on the application.

When the $V-I$ characteristic is plotted on a log-log graph, the curve of Figure 28 is obtained. Three regions result from the dominance of R_p , then R_v , and finally R_s as the current in the device increases from nanoamperes to kiloamperes.

The $V-I$ characteristic is then the basic application design tool for selecting a device in order to perform a protective function. For a successful application, however, other factors, discussed in

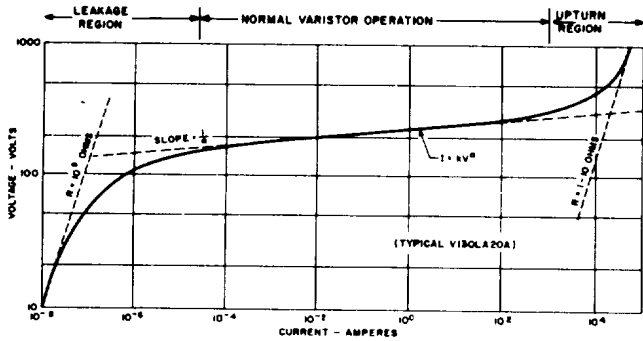

Figure 28. V-I characteristic of a varistor

detail in the information available from manufacturers, must also be taken into consideration. Some of these factors are:

- Selection of the appropriate nominal voltage for the line voltage of the application.
- Selection of the current-handling capability (including consideration of the source impedance of the transient, the waveshape, and the number of occurrences). Reference 31 provides general information on the selection process for these two factors, and Reference 8 gives an example of the problems which can occur when one attempts to provide a relatively low clamping voltage by using a device found by hindsight to be insufficient for the environment.
- Proper installation in the circuit (lead length). Because experience has shown that the lead effects are sometimes misunderstood, two aspects of their importance are presented as case histories in Section 7.6.

6.5 Packaged suppressors

The need for protection and the opportunity to provide packaged protective devices to concerned computer users has prompted the marketing of many packaged suppressors, ranging from the very simple and inexpensive to the complicated (not necessarily much better) and expensive. The field has also seen a number of devices claiming energy savings in conjunction with transient suppression; there is no foundation for such a claim, and the issue, hopefully, has now been settled in a study published by EPRI.⁽³⁶⁾

Component surge protective devices such as gaps, varistors, or avalanche diodes are used by *manufacturers* for incorporation into the circuitry of their products. In contrast, packaged suppressors are applied by *prudent users* as preventive and complementary protection, or by *aggrieved users* as

retrofit protection. These packaged suppressors may contain only a single protective device or a combination of devices; they are available for power-line protection, for data-line protection, and also in combined power/data lines protection.

The combined power/data lines protection packages offer not only convenience for protecting both lines of peripheral or remote equipment but also, and very important, permit the implementation of a common reference (ground) between the power and the data line. This common reference can be located right at the point of installation, and thus realize the ground window approach discussed in the preceding section.

A new type of suppressor has also appeared on the market, the so-called "tracking protectors." This type of device provides a voltage-limiting action over a narrow band of deviation from the power-frequency sine wave, rather than the fixed, absolute voltage limit of clamping or crowbar devices. Typical circuits involve the switching on of a shunt capacitor when the instantaneous voltage deviation exceeds a preset limit.

Packaging of the suppressors accomplishes two desirable goals: convenience of insertion by the user and coordination of the design for multiple-component protective schemes. Unfortunately, this packaging sometimes intentionally obscures the principles of protection being offered, making an evaluation of performance claims difficult. The competitive nature of these products is an unavoidable reality, which does not justify obscuring performance characteristics, even if some users are only interested in simple assurances that the devices packaged will provide them with adequate protection.

One reason for the frequent lack of information on the performance of the packages being offered is a lack of standards that would provide manufacturers and users with realistic and uniform application requirements. Component protective devices have the benefit of presently available test specification standards,⁽²⁴⁻²⁷⁾ but standards-writing groups have not yet completed their projects on packaged suppressors. In particular, the IEEE has an ongoing project that will take several years of work before publication; the Underwriters' Laboratories (UL) are approaching release of a document⁽³⁶⁾ that will provide not only safety guidance but also a more uniform basis of comparison of the packages being offered in the trade.

As an example of power line packaged suppressors, the recently introduced General Electric VSS device offers plug-in protection with both line-to-

neutral and neutral-to-ground protective devices (Figure 29). Further protection against low-level, high-frequency disturbances is obtained with the VNS device, which has an L-C filter added to the package (Figure 30).

The presence of neutral-to-ground protection in these two packages is a definite improvement over the simpler packages, which provide only line-to-neutral or neutral-to-line protective devices. Each of these two simpler devices may leave parts of the "protected" load unprotected during the occurrence of certain types of surges, as mentioned in the common mode/normal mode discussion of the preceding section. Figure 31 illustrates the complete protection provided by the dual devices, and Figure 32 shows the incomplete protection of the simple devices, where a normal mode

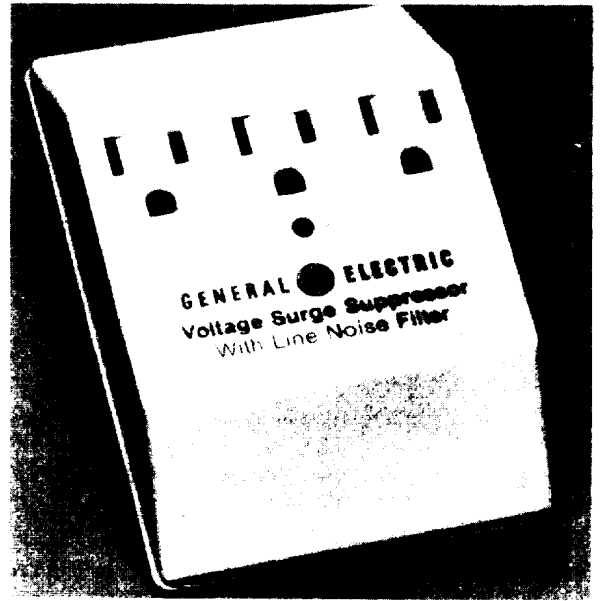

Figure 30. General Electric VNS suppressor

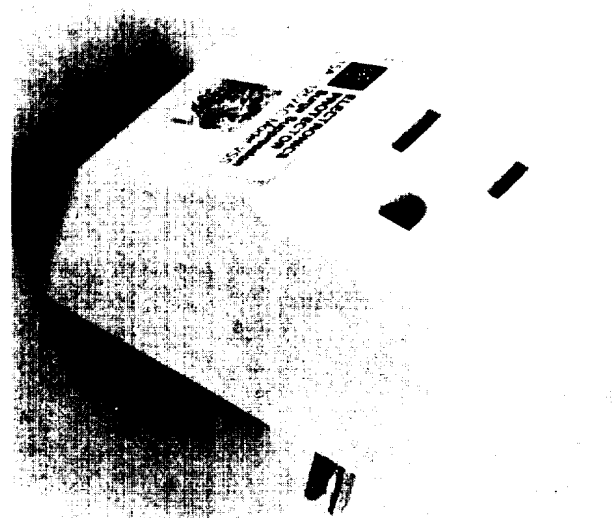
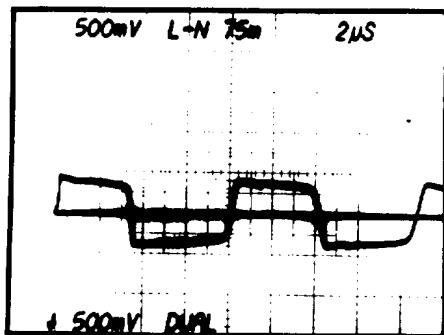

Figure 29. General Electric VSS suppressor

surge is converted into a voltage transient between the neutral and the grounding conductor.

6.6 Line conditioners as surge suppressors

The need to provide "clean power" to sensitive electronic equipment has promoted the development of a wide variety of devices generally described as "line conditioners." Depending upon the design and principle involved, these devices can perform several of the following functions: line isolation, voltage regulation (medium- and long-term), noise suppression, surge suppression, common mode suppression, and back-up power supply. Close inspection of the specifications is



(a) Voltage between line and neutral

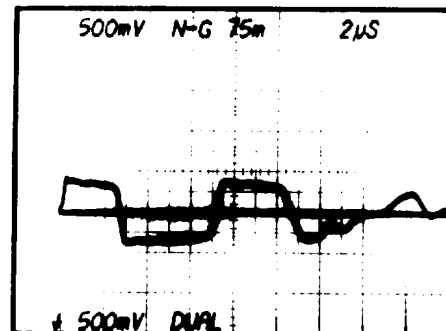

(b) Voltage between neutral and ground

Figure 31. Clamping of the ANSI/IEEE C62.41 ringwave vs the VSS suppressor

Vertical: 500 V/div

Sweep: 2 μ s/div

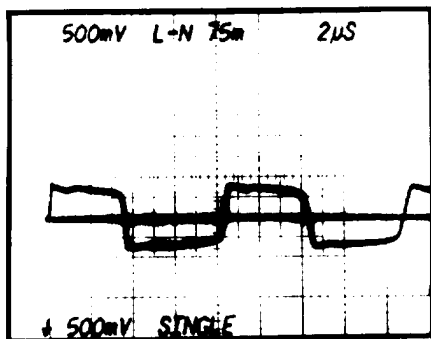

A. Line-to-neutral voltage

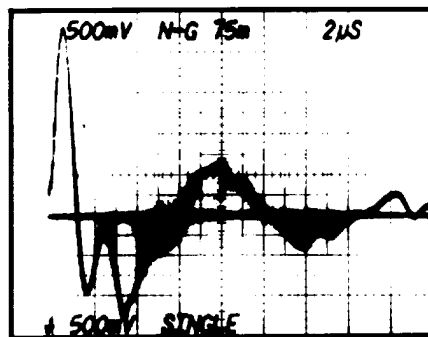

B. Neutral-to-ground voltage

Figure 32. Incomplete protection by a single suppressor at the end of a branch circuit with normal mode ringwave applied at the service entrance

Vertical: 500 V/div

Sweep: 2 μ s/div

required to distinguish the details of the performance of these devices. Their principle of operation can be used to categorize the types:

- Ferroresonant transformers (primarily regulation)
- Isolation transformers with filters (primarily common-mode decoupling)
- Motor-generator sets (primarily decoupling and short-time ride-through)
- Magnetic synthesizers (primarily regulation)
- Electronic synthesizers (primarily regulation)
- Electronic rectifiers/battery/inverters (primarily uninterruptible power supplies)

When properly understood and applied, these devices can provide not only their desired primary functions, but surge suppression as well — a welcome side effect. A notable exception, resulting from misunderstanding of the application, is discussed in Case History No. 4.

6.7 Failure modes

Failure of an electrical component can occur because its capability was exceeded by the applied stress or because some latent defect in the component went unnoticed in the quality control processes. While this situation is well recognized for ordinary components, a surge protective device, which is no exception to these limitations, tends to be expected to perform miracles, or at least to fail gracefully in a fail-safe mode. The term “fail-safe,” however, may mean different failure modes to different users and, therefore, should not be used. To some users, fail-safe means that the protected *hardware* must never be exposed to an overvoltage, so that failure of the protective device must be in the fail-short mode,

even if it puts the system temporarily out of operation. To others, fail-safe means that the *function* must be maintained, even if the hardware is left temporarily unprotected, so that failure of the protective device must be in the open-circuit mode. It is more accurate and less misleading to describe failure modes as fail-short or fail-open, as the case may be.

When the diverting path is a crowbar-type device, little energy is dissipated in the crowbar, as noted earlier. In a voltage-clamping device, because more energy is deposited in the device, the current-handling capability of a candidate protective device is an important parameter to consider in the design of a protection scheme. With nonlinear devices, an error made in the assumed value of the current surge produces little error on the voltage developed across the protective device and thus does not affect the protective function (Figure 33). However, the error is directly reflected in the amount of energy which the protective device has to absorb. At worst, when surge currents in excess of the protective device capability are imposed by the environment (for example, an error made in the assumption, a human error in the use of the device, or nature’s tendency to support Murphy’s law), the circuit in need of protection can generally be protected at the price of failure of the protective device in the short-circuit mode. However, if substantial power-frequency currents can be supplied by the power system, the fail-short protective device generally terminates as fail-open when the power system fault in the failed device is not quickly cleared by a series overcurrent protective device (fuse or breaker).

Assume an open-circuit voltage of 3000V

1. If the source impedance is $Z_s = 50\Omega$ with a suppressor impedance of $Z_v = 8\Omega$ the expected current is:

$$I = \frac{3000}{50 + 8} = 51.7\text{A and } V_R = 8 \times 51.7 = 414\text{V}$$

The maximum voltage appearing across the terminals of a typical nonlinear V130LA20A varistor at 51.7A is 330V.

Note that:

$$\begin{aligned} Z_s \times I &= 50 \times 51.7 = 2586\text{V} \\ V_R \times I &= 8 \times 51.7 = 414\text{V} \\ &= 3000\text{V} \end{aligned}$$

2. If the source impedance is only 5Ω (a 10:1 error in the assumption), the voltage across the same linear 8Ω suppressor is:

$$V_R = 3000 \frac{8}{5 + 8} = 1850\text{V}$$

However, the nonlinear varistor has a much lower impedance; again, by iteration from the characteristic curve, try 400V at 500A, which is correct for the V130LA20A; to prove the correctness of our "educated guess" we calculate I.

$$I = \frac{3000 - 400\text{V}}{5} = 520\text{A.} \quad \begin{aligned} Z_s \times I &= 5 \times 520 = 2600\text{V} \\ V_C &= 400\text{V} \\ &= 3000\text{V} \end{aligned}$$

which justifies the "educated guess" of 500A in the circuit.*

Summary

3000V "OPEN-CIRCUIT" TRANSIENT VOLTAGE

| Protective Level Achieved | Assumed Source Impedance | |
|---------------------------|--------------------------|-------|
| | 50Ω | 5Ω |
| Linear 8Ω | 414V | 1850V |
| Nonlinear Varistor | 330V | 400V |

Similar calculations can be made, with similar conclusions, for an assumed error in open-circuit voltage at a fixed source impedance. In that case, the linear device is even more sensitive to an error in the assumption. The calculations are left for the interested reader to work out.

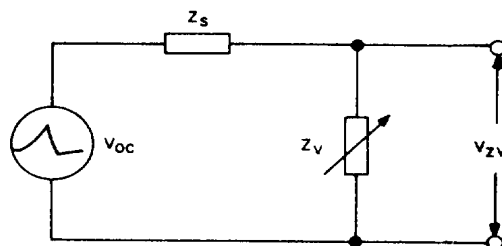

*An educated guess, or the result of an iteration

Figure 33. The importance of correct assumptions on some impedance when using nonlinear surge protective devices

With the failure mode of a suppressor being of the fail-short type, the system protection with fuses can take two forms (Figure 34). For the user concerned with maintaining the protection of expensive *equipment*, even if failure of the protector means the loss of the function, Alternative A must be selected. Conversely, if the *function* is paramount, Alternative B must be selected.

7. EXAMPLES AND CASE HISTORIES

To illustrate the preceding considerations, some practical examples are given in this section as the basis for sound design approaches, or as horror tales where the names of the "guilty" have been withheld: it is always easy, with hindsight, to see what should have been done, but less easy at the outset for engineers unfamiliar with surge protection and more concerned with other system considerations.

These case histories show how unintentional but clear violations of the principles described in this report resulted in the problems that follow:

- Case 1: Ground potential differences on data lines caused by discontinuous shield
- Case 2: Ground potential differences on power lines caused by ignorance of the ground window approach
- Case 3: Insufficient and poor utilization of protection
- Case 4: Misunderstanding of common versus normal mode
- Case 5: Controversies on connection options
- Case 6: Measurement problems
- Case 7: Unwanted surge suppression by an instrument
- Case 8: Undersized protective device

The detailed explanations of the problems and cures in these case histories are offered as a help to avoid these types of pitfalls.

7.1 Case History No. 1 – Computer graphics system: Ground potential difference on data lines

A CAD/CAM graphics system had been installed by a computer graphics vendor linking a central processing unit to remote terminals located in separate buildings. In a span of 5 weeks during the first summer after the system was commissioned, three lightning storms occurred in the

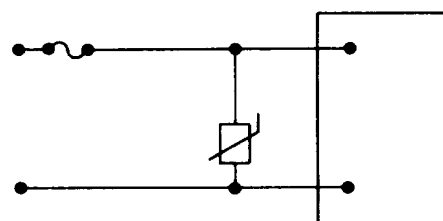

A - Protection maintained,
function interrupted

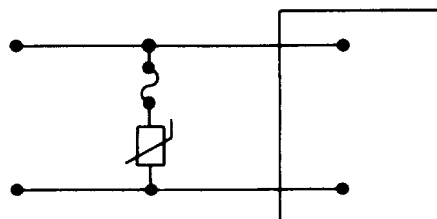

B - Function maintained,
protection lost

Figure 34. Fusing alternatives for suppressors

area; no direct strikes were reported on the buildings, but extensive damage was done to the circuit boards on terminals and central processing unit (CPU) inputs.

After the first occurrence, power line surges were suspected and some precautions were applied, when access to the hardware was possible, by pulling out the ac power plugs from the CPU or terminals at the onset of a lightning storm. This did not help. Next, isolating transformers were installed but, again, did not help. At this point, the author was called in for consultation, and the following proposed diagnosis was established: the surges were not coming from the ac lines but, rather, were due to differences in the ground potential existing between the separate buildings during flow of lightning currents. The data cables had been run in plastic conduit buried between the buildings and, true to the controversial tenet of steady-state noise prevention, only one end of the shield of the wire pairs had been grounded, with the other left floating. Figure 35 shows how this arrangement can produce high voltages between a floating end of the shield and the local ground, an arrangement that is bound to produce a flashover and flow of surge currents along unwanted paths in the circuit components. Thus, the problem was *not* power line surges but differential ground potential. Worse, by pulling out the ac line plugs but leaving the incoming data cables connected, the operators had unwittingly removed the local

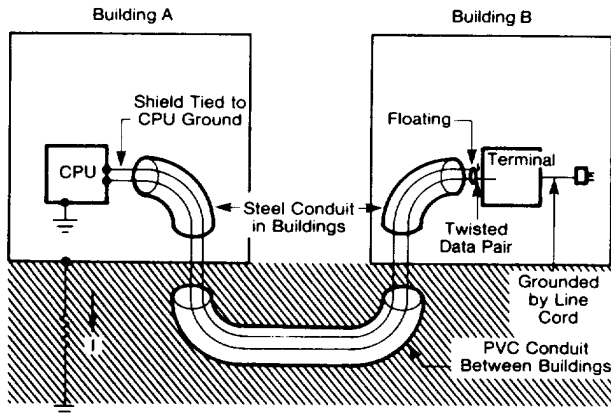

Figure 35. Shield connections of data cables

grounding connection of the hardware frame, leaving only the data cables coming in, with a possibility of raising the complete hardware several thousand volts above local grounds in the room — a dangerous condition.

A solution to the problem could take several approaches. Radical solutions, such as a microwave link or a fiber optics bundle, would indeed have eliminated the differential ground potential problems, but were considered too expensive or too long to install.

Incidentally, part of the original bewilderment at the failures was the notion that opto-isolators provided in the data link route should have served to avoid problems. Close scrutiny of the circuits, however, disclosed that the opto-isolators had been provided for some other purpose; in fact, the ground potential loop was closed by the power supply to the opto-isolator feeding the amplifiers from a local source rather than the remote source, negating the isolation function.

Another solution, really the most simple and effective in principle, would have been the replacement of the plastic underground conduit by a continuous steel conduit linking the steel conduits used inside the buildings. This additional metal would have provided equalization of the ground potentials along the data cable, while allowing, within the conduit, the desired use of shields with one end only at ground. However, that solution was not acceptable to the plant facility organization. (One does not dig up the front lawn two times within a few months at an industrial park!)

In this particular location, a spare conduit, buried next to the data line conduit, offered the possibility of pulling a heavy ground cable in the spare conduit, close to the data cables. This cable

could then bond the two corners of the building's steel frame at the point of entry of the data cables, as a first step toward reducing differential ground potentials. At first, this concept was somewhat difficult to sell to plant facilities: because there is a ground grid tying the two buildings for 60 Hz faults, further ties between the two buildings did not seem necessary. However, our thesis was that this grid would have too high an impedance to serve the purpose, and furthermore that the data cable run, located away from the ground grid, would form a flux-collecting loop with the ground grid. After lengthy discussions, the thesis was accepted and the cable was installed.

Simultaneously, the concept of tying the two ends of the cable shields to ground was proposed, with the provision of a barrier that would avoid the circulation of power-frequency currents:⁽³⁸⁾ inserting an array of diodes (Figure 36) at one end of the shields reconciled the need for noise prevention during normal operation and the requirement of grounding at both ends during lightning events. The forward drop of the two diodes in series (1.5 V) was enough to block any 60 Hz circulating current that would inject noise into the data cables. During a lightning strike, however, the diodes would allow flow of current to compensate and cancel the ground potential differences.

These two cures were implemented during the summer of 1980, and no further problems occurred for the rest of the lightning season of that year. While these two solutions might have been sufficient, the concern over another possible failure of the system was sufficient to motivate the design of further protection: the insertion of a voltage clamp in each data pair. This solution required some design and acceptance testing from

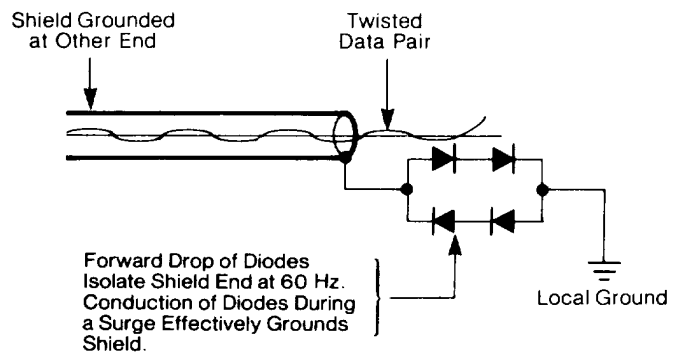

Figure 36. Diode array for grounding both ends of shield during a surge

the computer vendor, so that it was not implemented until the next lightning season, the spring of 1981. Thus, the system survived all of the remainder of the 1980 lightning season with only the first two remedies.

Voltage clamps were designed for insertion at each end of the data cable, at the point where the cables were terminated prior to connection to the CPU or to the terminal (Figure 37). The objective was to clamp any transient developed in the pair, with respect to ground, at less than 25 V, without introducing excessive degradation of the pulses' fronts in the signals transmitted by the cables. Vendors of hybrid protection packages were consulted and samples were obtained for evaluation. All these samples consisted of a gas tube protective device connected between the line and ground and followed by some resistance, and a silicon avalanche suppressor between line and ground (Figure 38). The criteria were the optimization of the RC parameters of the suppressor — R being the series resistance, and C the capacitance of the silicon diode — for maximum suppression with limited and acceptable decrease in the steepness of the data pulses.

During evaluation testing of the various candidate suppressors submitted by prospective vendors, it became apparent that the physical layout of the components had an effect on the clamping voltage obtained: when the gas tube gap sparked over, the high di/dt in the gap produced a high $d\phi/dt$ in adjacent loops, in particular the loop involving the second-stage avalanche diode and the load (Figure 39). While the clamping voltage of the avalanche diode was, in fact, 15 V, as much as 45 V spikes were recorded across the output of the packaged hybrid suppressors, raising doubts about the effectiveness of the protection. These spikes were extremely short (nanoseconds), but the vendor of the integrated circuits that had failed in the initial problems would not agree to consider more than the specified maximum 25 V overvoltage, even for these very short spikes.

Since the proposed connection between the interface box in the terminal or CPU rooms and the terminal equipment involved a flexible connection by shielded pairs, a simple solution was possible. The inherent capacitance of the pairs to their shield, combined with an additional resistance at the output of the hybrid suppressor could reduce this induced spike below 25 V (Figure 40). Thus, an acceptable package was designed, providing for the clamping of any surge to a level below the tolerance level of the integrated circuits of the line drivers or line receivers, but still not producing an

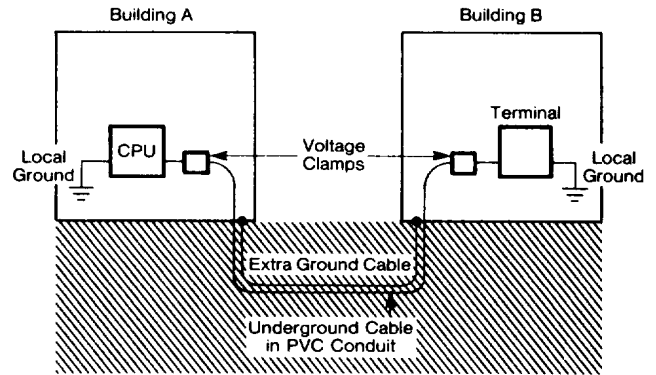

Figure 37. Insertion of voltage clamps at interfaces

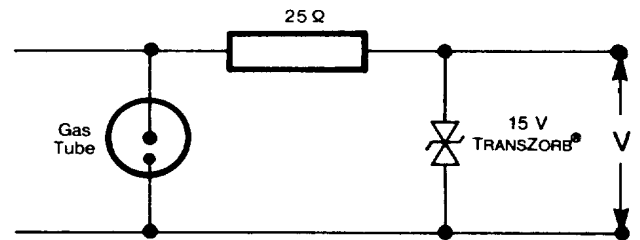

Figure 38. Voltage clamping retrofit on data cable

objectionable degradation of pulse fronts. The complete protection scheme was installed before the 1981 lightning season, and no further problems have been reported.

Experience has shown that conclusions on the effectiveness of lightning protection schemes should wait perhaps as much as 10 years before being proclaimed, because of the large variations in lightning activity. However, after several years of trouble-free operation compared to three major failures in 5 weeks, the cure would seem effective.

In retrospect, then, the following recommendations can be drawn from this horror tale,* for retrofits or new installations:

1. Data cables linking separate buildings or spanning beyond a single room within one building should have a shield tied to local ground at both ends of the cable. If the first shield provided with the cables must be left with one end floating by *diktat* of the system vendor, then these cables should be installed within a *continuous* metal shield. This continuous shield can be either a double shield of the flexible cable or simply a metal conduit *with both ends grounded* and proper attention to maintenance of its continuity.

* Which, in the last several years, was found repeated at several other facilities involving different systems but the same basic problem. Thus, this case history has achieved the status of "classic" or "textbook" importance.

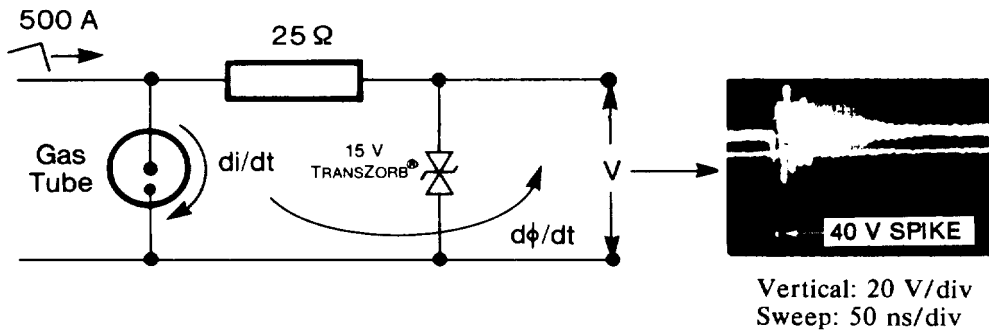

Figure 39. Voltage induced by gap sparkover

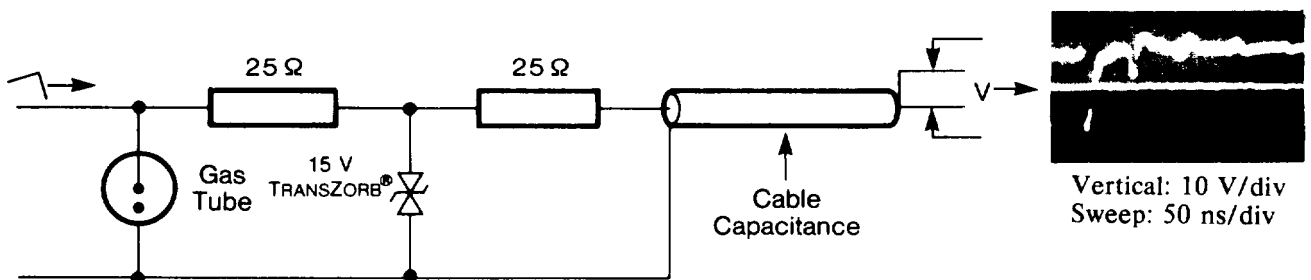

Figure 40. Reduction of induced voltage

2. Substantial relief can be obtained in retrofits by grounding both ends of existing shields through a low-voltage clamp, such as a diode array, that will block noise-inducing power frequency currents but will allow the flow of ground-potential equalizing currents during surges.
3. The ultimate protection may be the insertion of surge-protective devices in each line. However, this solution requires careful design so that degradation of the signals does not occur and residual spikes are not allowed to pass through.
4. While *damage* prevention can be accomplished by these approaches, *data errors* may still be produced. If data integrity is an absolute requirement, metallic connections should be avoided for data links spanning remote terminals.

7.2 Case History No. 2 – Computer-aided industrial control: Ground potential differential on the power lines (absence of ground window)

In this situation, a novel adaptive control using sophisticated microprocessor-based sensors and

phase-control of power thyristors, limited to a single room in a building, had suffered system crashes and memory component damage on repeated occasions. Suspicions developed that there was some correlation between the crashes or damage and the operation of another developmental power system in an adjacent laboratory. The software engineers working on the control system were attempting to continue their work by staggering the schedule with their neighbors; they were also considering installation of an independent power feeder to their system.

From another point of view, focused by the author, this case presented an opportunity to learn, while still in the laboratory, what the real world can inflict on unprotected computerized power systems. Rather than blame the power supply, a more fruitful approach for the long run would be to develop immunity to interference and damage. In defense of the system designers, it should be pointed out that their system had enough challenges to be tackled in the main objectives that it might have seemed reasonable to overlook the interference problems in the initial stages. Sooner or later, however, the ignored problems will crop up, and, sooner is better than later when fundamental design concepts are involved.

A review of the total system revealed the existence of ground loops. On one side, the power supply for the computer and some signal processing circuits were obtained from the room outlets of the laboratory 120 V system, including the grounding conductor (green safety wire). On the other side, the power supply for the high-power circuit was obtained from a feeder coming directly from the building power center, including again a grounding conductor run alongside this power line, properly installed by electricians, and bonded to the frame of the machine being controlled. One of the signals used for controlling the process was derived from a voltage pickup referred to the frame of the machine, while the chassis of the computer and its zero reference were bonded to the grounding conductor of the 120 V room supply. Thus, a double ground loop was formed: one between the grounding conductor of the 120 V room supply and the power-feed grounding conductor, and the other between the overall zero reference of the signal processing and the voltage pickup with its separate ground reference (Figure 41).

With hindsight, it was not difficult to conclude that during transient conditions involving the high-power feed to this system and the neighboring system, substantial current could flow between the two grounding wires linked by the computer reference wiring. An immediate cure was to open this path for surge ground currents by inserting an isolating transformer in the 120 V supply to the computer, and bonding the secondary side of this transformer to the single ground point derived from the high-power feed (a National Electrical Code requirement). This correct application of an isolating transformer, to open a ground loop, is in contrast to the misconception that isolating transformers can eliminate line-to-line spikes, as discussed in Case History No. 4.

Opening the second ground loop involving the voltage pickup could not be as readily implemented because it required a differential voltage pickup circuitry. Plans for further refinements of the system included this change, but even with only the first ground loop opened, the major crashes and damage stopped; only occasional interference occurred, probably not associated with the second ground loop but, rather, with a more subtle software problem associated with sensing the power flow in the system. Clearly, the first ground loop was one of the major sources of the problem, a problem that would have been avoided if the system had been arranged with a single ground window.

7.3 Case History No. 3 – Outdoor recorder retrofit: Insufficient surge protection against line-to-ground surges

In this case history, a field failure problem was caused by a lack of awareness (on the part of the circuit designer) of the degree of hostility in the environment where the circuit was to be installed. A varistor had been provided to protect control circuit components on the printed circuit board, but its capability was exceeded by the surge currents occurring in the particular location. In defense of the circuit designer, however, it must be stated that he was unaware of the data published in IEEE Std 587 (now ANSI/IEEE C62.41).

Since a number of devices were in service, complete redesign was not possible, and a retrofit – at an acceptable cost – had to be developed. Fortunately, the power consumption of this control circuit was limited, so that it was possible to insert some series impedance in the line, ahead of the low-capacity varistor, while a higher capacity varistor was added at the line

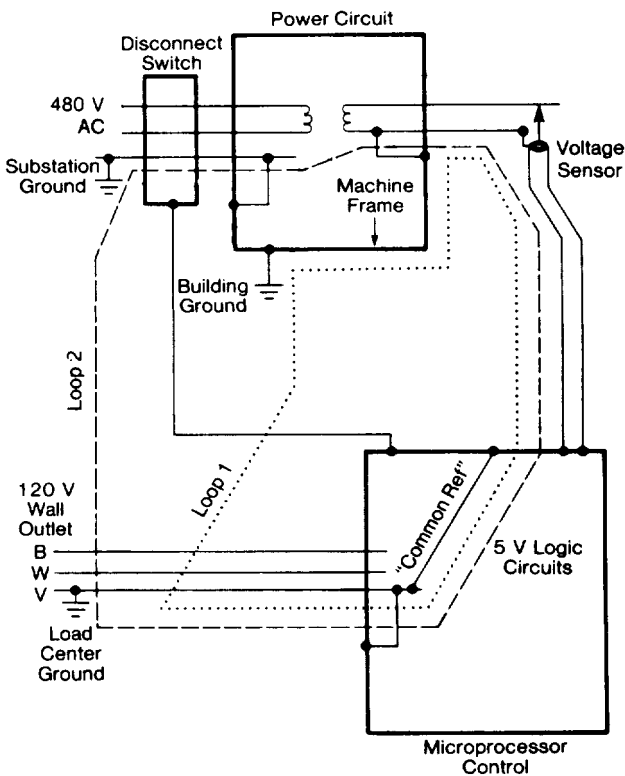

Figure 41. Ground loops in power and control systems

entrance to the circuit (Figure 42). Laboratory proof-testing of the retrofit demonstrated the capability of the combined scheme to withstand 6 kA crest current surges (Figure 43), which is a 200% margin from the suggested IEEE/ANSI C62.41 Category B level. Furthermore, it demonstrated reproduction of the field failure pattern (Figure 43). The latter is an important aspect of any field problem retrofit. By simulating in the laboratory the assumed surges occurring in the field, verification of the failure mechanism is the first step toward an effective cure. Figure 43 illustrates the effect of improper installation of the suppressor in a first retrofit attempt with 8 inches of leads instead of a direct connection across the input terminals of the circuit. The author has observed far too many applications of varistors with excessive lead lengths, to the point that the protection is substantially reduced for fast rising surges, the present case being typical.

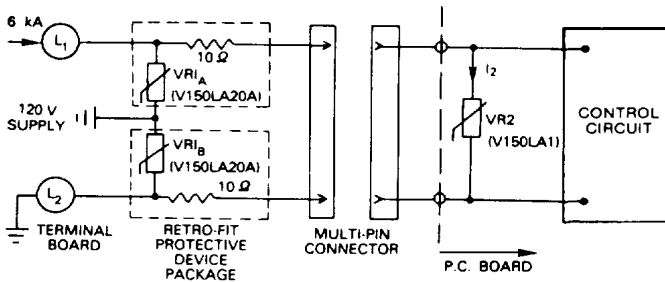
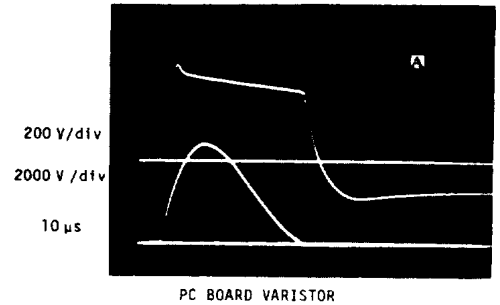

Figure 42. Retrofit of a protection package

7.4 Case History No. 4 – Does an isolating transformer help?

The author has witnessed and engaged in many discussions on the merits of isolating transformers, sparked by the misconception that “spikes are attenuated by transformers” or “spikes do not pass through transformers.” Figures 44 through 46 are offered to support the position that these quotations are misconceptions. When properly applied, isolating transformers are useful to break ground loops, but they do not by themselves attenuate spikes that occur line-to-line, the so-called “normal mode.”

Figure 44 shows the propagation – or worse, the enhancement – of a voltage impulse in a 1:1 isolating transformer. The 6 kV, 0.5 μs-100 kHz impinging wave of ANSI/IEEE C62.41 is applied to the primary of the transformer, H_1H_3 to H_2H_4 . The output voltage, measured at X_1X_3 to X_2X_4 , appears as a 7 kV crest on the secondary side of this “isolating” transformer.



Upper trace: Voltage across V150LA1 varistor on PC board, 200 V/div

Lower trace: Applied surge current, 2000 A/div

Sweep speed: 10 μs/div

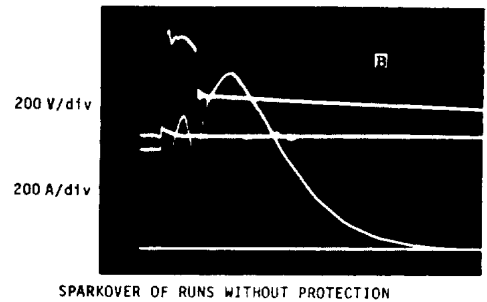

Additional surge protection removed: V150LA1 varistor on PC board is the only protection

Upper trace: Voltage across V150LA1 varistor

Lower trace: Varistor current 200 A/div. Sparkover occurs at about 700 A: 60 Hz power-follow destroys the PC board

Sweep speed: 10 μs/div



LONG LEADS

Same as A, but with varistor mounted on 8 in. leads from terminal board

Figure 43. Performance of retrofit package

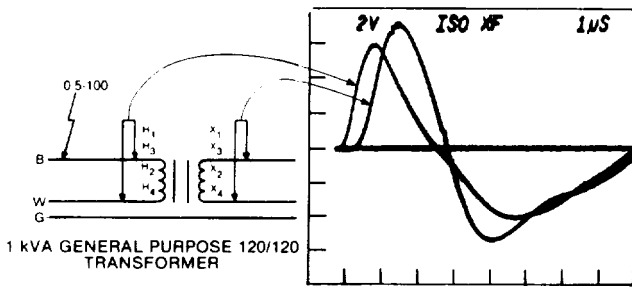

Figure 44. Surge propagation through isolating transformer

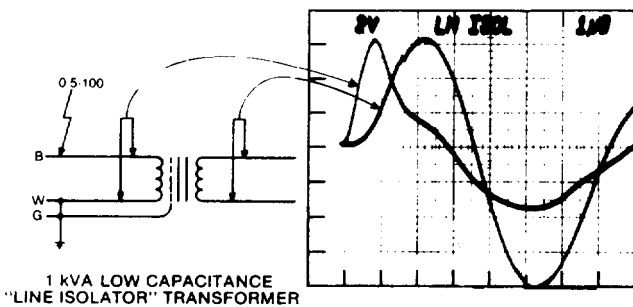

Figure 45. Surge propagation through "line isolator" transformer

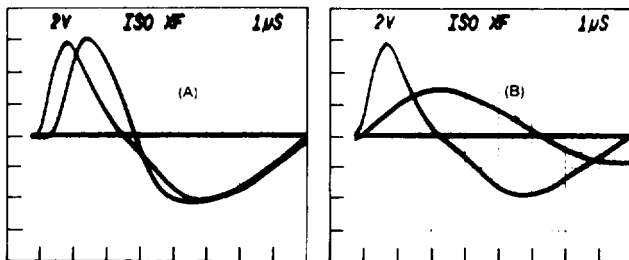

Figure 46. Effect of loading on the secondary side

Figure 45 shows the similar behavior of a transformer offered as a line isolator. This transformer is intended to provide low effective capacitance and ground loop isolation between primary and secondary windings, but here again, the author has observed that users of this device expect attenuation of spikes. The response of this isolator, due to its internal construction, is different from that of the simple two-winding transformer of Figure 44, but we also note that a crest of 8 kV occurs on the secondary side during the second half-cycle. Hardly an improvement.

Figures 44 and 45 were recorded with no load on the transformer secondary, which represents

the extreme case of a low-power electronic control in standby mode. Figure 46 shows the primary and secondary voltages of the transformer with a 10 W (1500 Ω) and a 100 W (150 Ω) load on the secondary side, at the same surge generator setting as Figure 44. With the 10 W load that might be typical of an electronic control in standby mode, the combined series reactance of the transformer and shunt resistance of the load produce the output shown in Figure 46, still slightly higher than the input.

With the 100 W load shown in Figure 46, the attenuation is now apparent, but is only 2:1. Capacitive loads would, of course, produce a greater attenuation than resistive loads for the inductive series impedance of the transformer, at the frequency spectrum of this fast, 2 μs, wide spike. For surges of longer duration, the attenuation would be even smaller.

These examples show that, unless a well-defined load is connected to the transformer, expecting attenuation from the transformer may prove to be hazardous to the health of low-power electronics connected on the secondary side of a transformer.

By contrast, decoupling is possible with a ferroresonant line conditioner which is primarily intended for line voltage regulation but which also provides a high degree of surge suppression. Figure 47 shows the 6 kV incoming wave being attenuated to 60 V (100:1) on the secondary side of the unloaded line conditioner, and to 40 V (150:1) with a load of only 10%; at full load, an

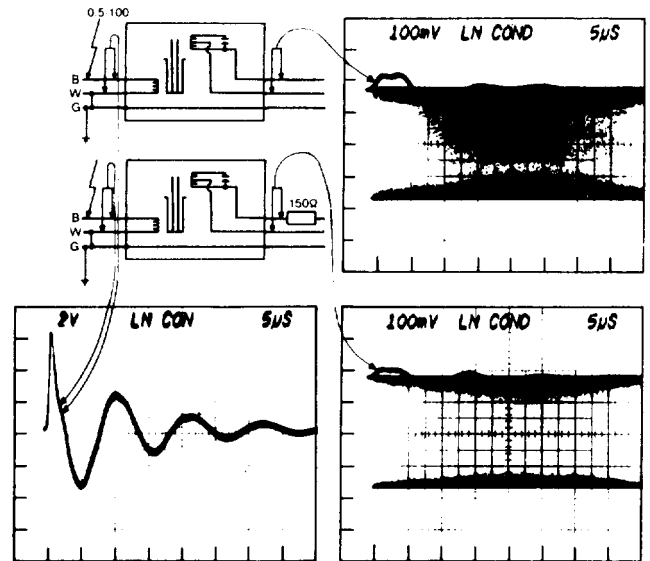

Figure 47. Surge decoupling by ferroresonant line conditioner

attenuation to less than 10 V was observed. The nature of the ferroresonant line conditioner is such that the decoupling improves with loading, while the simple transformers of Figures 44, 45, and 46 can only act as linear dividers with load changes. Conversely, the decoupling between primary and secondary sides of the line conditioner is further seen on the oscillogram recorded on the input side of the line conditioner. This oscillogram is, in fact, a photograph of two successive measurements, one with no load on the line conditioner and one with a 100 W load. The input waves are exactly superimposed.

This decoupling reflects the nonlinear behavior of the ferroresonant line conditioner, which is significant in this case, compared to the linear behavior of transformers: For surge sources of lower impedance than the generator used in these tests, or for frequencies lower than the frequency contained in the $0.5 \mu\text{s} - 100 \text{ kHz}$ spike, the transformer attenuation would become lower, in direct proportion to the corresponding impedance change, while the ferroresonant line conditioner would keep the decoupling unchanged. See also Case History No. 7 for an application of a ferroresonant line conditioner to decouple a surge protective device from the power supply, the inverse situation of what is described here.

For worst-case demonstration, the two oscillograms of the output were recorded with the spike timed to occur at the peak of the 60 Hz line voltage demonstration. The peak-to-peak amplitude of the line voltage is indicated by the gray band recorded on the oscillograms by photographically superimposing repetitive traces of the line voltage. For timings other than at peak, the small voltage oscillation on the output voltage would be completely contained within the normal peak-to-peak band of the 60 Hz line voltage.

7.5 Case History No. 5 – Connections options for suppressors and effects on residual voltages

The author has witnessed lively controversies over the most effective transient suppression configuration to be applied. Taking, as an example, the task of specifying the protection of an appliance or equipment connected at the end of a line with no opportunity to divert the transient closer to the source (for instance, at the service entrance), the options would be to connect one, two, or three varistors between the three wires (black, white, and green) at the end of the line. However, additional information needs to be

known: Will the impinging surge be in the normal mode (black-to-white) or in the common mode ([black-and-white]-to-green)? Where in the equipment is the most sensitive component: line-to-line (most likely) or line (black or white)-to-green? Clearly, the situation is confusing, and there will not be a single, simple answer applicable indiscriminately to all cases. The National Electrical Code⁽³⁹⁾ specifically allows the connection of *surge arresters* between neutral and grounding conductors (Article 280-22) if the interconnection occurs only by operation of the surge arrester during the surge. Since the standby current of varistors is very low, this requirement can be met; furthermore, there will not be any interference with the operation of Ground Fault Circuit Interrupters if there are only a small number of protectors.

The set of measurements recorded in Figure 48 shows an example of these many options with increasing protection, albeit at increasing cost, from a single varistor to three varistors. The selection would depend on the vulnerability level and location of the equipment to be protected. The impinging surge is assumed to be black-to-[white-and-green], since white and green are tied together at the service entrance. The line is a 75 m line and the surge is that available from the generator set for a 2000 A $8/20 \mu\text{s}$ short-circuit impulse. Rather than attempt to modify the setting of the generator for each case in order to maintain a constant current crest for the various configurations (an impossible task if waveform is also to be maintained), the generator was left unchanged, to discharge a constant total energy into the system – not a bad hypothesis for the real world. The current crests are all in the range of 300 to 380 A, which is not a significant variation for comparing varistor clamping voltages.

If only one varistor is allocated to protect the equipment, the black-to-white varistor connection (first row) affords maximum protection for the electronics, which are also likely to be connected black-to-white. However, the voltages between either black or white and green are large; that voltage is the stress that will be applied to the clearances of the equipment. This situation is a good example of the conversion of a normal mode transient into a common mode, as discussed in Section 6.5.

The configuration with varistor black-to-green (second row) does not afford very good protection for components connected black-to-white; therefore, it should be used only if there is a special

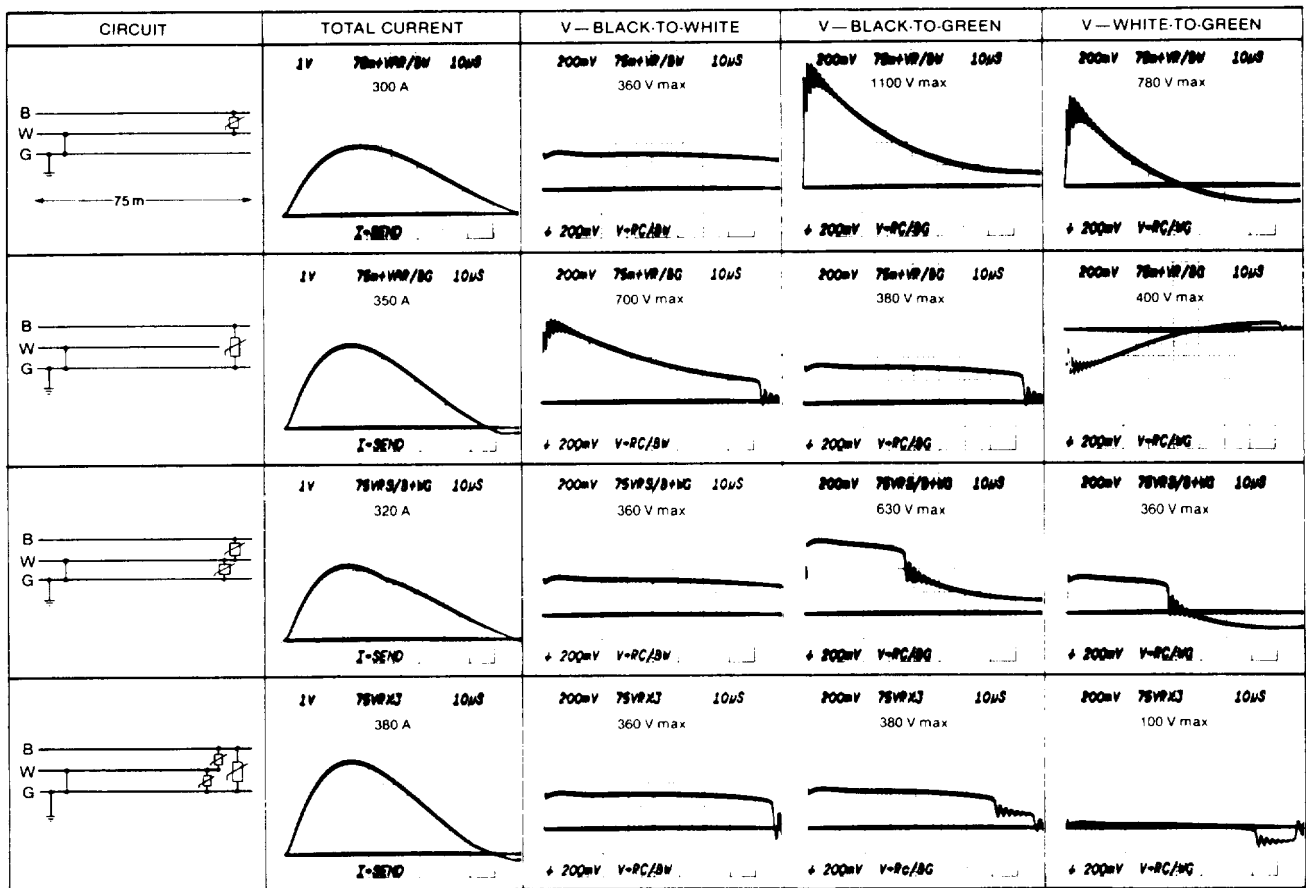

Figure 48. Connections options and effect on common mode or normal mode overvoltages

need to clamp black-to-green at a low voltage with only one varistor available or allowed.

An improved protection is obtained with a varistor connected black-to-white, complemented by a second varistor connected white-to-green (third row). The ultimate protection is, of course, one varistor in every position (fourth row), but this should be required only for exceptionally sensitive loads.

7.6 Case History No. 6 — Measurement problems

Considerable controversy has been raised on an "overshoot" associated with the performance of varistors under fast pulses. Actually, this overshoot is primarily a measurement problem associated with lead effects. To illustrate the effect of lead length on the overshoot, two measurement arrangements were used. As shown in Figures 49(a) and 49(b), respectively, 0.5 cm² and 22 cm² of area were enclosed by the leads of the varistor and of the voltage probe.

The corresponding voltage measurements are shown in the oscillograms of Figures 49(c) and 49(d). With a slow current front of 8 μs, there is little difference in the voltages occurring with a small or large loop area, even with a peak current of 2.7 kA. With the steep front of 0.5 μs, the peak voltage recorded with the large loop is nearly twice the voltage of the small loop. Note in Figure 49(d), that at the current peak $L di/dt = 0$ and the two voltage readings are equal; before the peak $L di/dt$ is positive and after, it is negative.

Other measurement errors can be introduced by the connection of the voltage probes, as illustrated by the following experiment. When making voltage measurements across a clamping device for evaluating its performance, one must recognize possible difficulties requiring special precautions. Two precautions must be taken:

1. Use two probes in a differential mode to make a measurement directly at device terminals. Commercial oscilloscope preamplifiers offer a wide

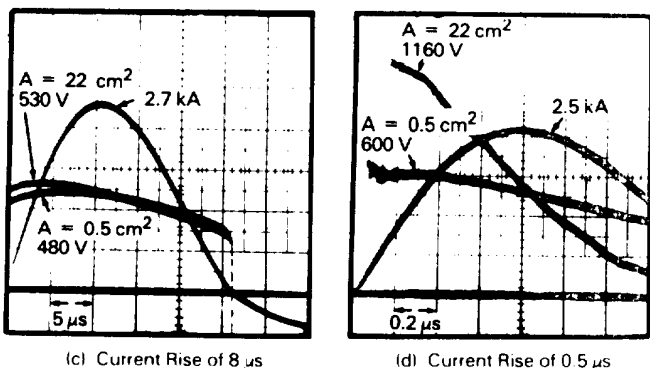
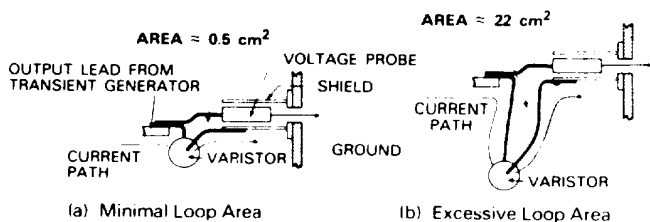

Figure 49. Effect of lead length on overshoot

choice of differential mode operation, either through a mode (add Channel A + invert Channel B) with two-channel preamplifiers, or through a differential amplifier built specifically for high common mode rejection, sometimes at the expense of bandwidth. Thus, careful attention must be given to this aspect of measurements.

2. Avoid contaminating the true device voltage by the additional voltage caused by magnetic coupling. The voltage measured by the two probes is the sum of the actual clamping voltage existing across the device and a spurious voltage caused by magnetic coupling. This spurious voltage is induced into the loop formed by the clamping device length and the two probes by the changing magnetic field of the current flowing in the device.

To illustrate the second point, the measurement circuit shown in Figure 50 was set up in the output circuit of a generator producing a $8/20 \mu\text{s}$ impulse. The "device" was a hollow conductor, with a hole at the center through which a twisted pair was fed, one wire of the pair branching out to each end of the conductor, separated by 10 cm. At the same 10 cm separation, but outside of the hollow conductor, two thin wires were attached and brought to the midpoint of the hollow conductor, in close contact with the conductor; from the midpoint outward, they were twisted in the

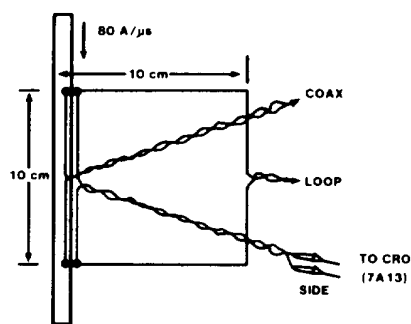

Figure 50. Circuit configuration

same manner as the inside pair. A third set of wires was soldered at the end points of the hollow conductor, and arranged to form a rectangle, the hollow conductor being one side of that rectangle. Several widths could be set up for the rectangle, and each time the measured voltage was recorded. Figure 52 shows the measured voltage versus radial distance of the opposite side of the rectangle, plotted from the oscillograms of Figure 51.

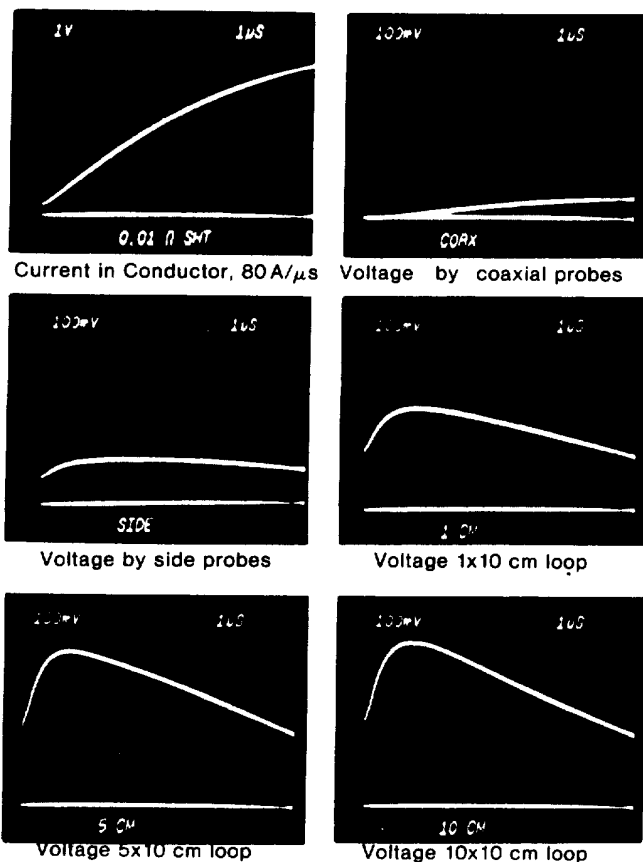

Figure 51. Voltages recorded for various probe connections

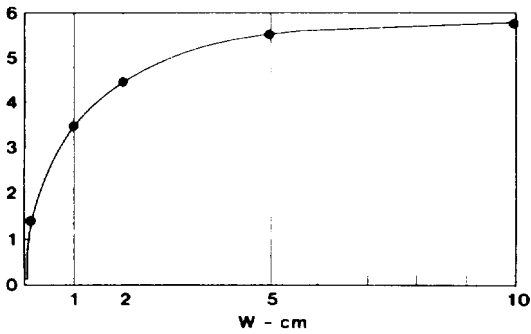

Figure 52. Voltage versus area

This experiment shows that not only must one connect the probes as close as possible to the terminals of a clamping device but still strive to minimize the area established by the probes close to the device.

In the case of a low-voltage suppressor, it would be better to solder short leads to the device terminals, bring them together while tightly hugging the device, then twist them in a pair and connect the oscilloscope probes some distance away from the device.

This experiment also shows the importance of wire layout in making the connections of a protective device in an actual circuit. As discussed in Case History No. 1, creating a loop near the protective device is an invitation to induce additional voltages in the output of the protective device, thus losing some of its effectiveness.

Hence, when one is making measurements as well as when one is designing a circuit for a protection scheme, it is essential to be alert to the effects of lead length (or more accurately of loop area) for connecting the varistors. This warning is especially important when the currents are in excess of a few amperes with rise times of less than 1 μ s.

7.7 Case History No. 7 – The best surge suppressor is a surge monitor!

Increasing recognition of the existence of transients on power lines has encouraged extensive use of commercial disturbance analyzers as a first step in identifying a potential transient problem. Surveys have also been made on the quality of the available ac power, based on recordings obtained from such analyzers. However, the results of such measurements may be ambiguous as a result of the design of at least one of these instruments, as made by Dranetz Technologies, Inc., until recently.

The problem arises from a characteristic of the Dranetz equipment, which exists for both Models

606 and 626, and which was not recognized at the time some measurements were made but is now pointed out in more recent Dranetz instruction manuals.

In order to protect the electronics of the Disturbance Analyzer from damage by overvoltages in the power supply to these internal electronics, a surge suppressor has been provided in the input to the power supply – not the monitoring input of course. However, if the ac power system being monitored is the same as the power system in which the instrument power supply cord is plugged – a likely possibility in the general case and precisely the situation of some reported measurements – then the observations of surge occurrences on that power system are those of a system whose transients have been suppressed!

To support this claim, Figure 53 shows an oscillogram recorded at the output of a surge generator which provides both 120 V ac power and the IEEE/ANSI C62.41 Ring Wave, Category B. The oscillogram shows the surge without the Dranetz analyzer plugged into the test system output, and, superimposed, the effect of plugging the *power cord only* of the Dranetz analyzer into the test system output. Without the analyzer, the open-circuit voltage is 3 kV; with the analyzer plugged in, the output voltage is reduced to 1.1 kV.

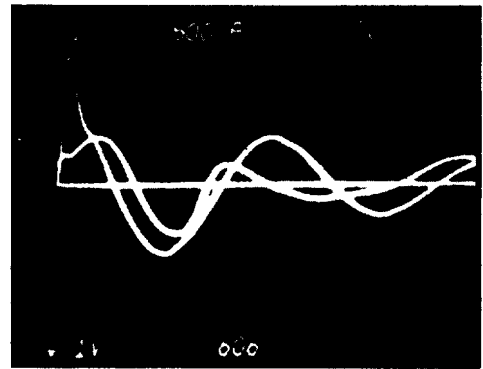

Figure 53. Open-circuit voltage output of KeyTek surge generator Model 711 with P1 plug-in and attenuated voltage with Dranetz 606 power cord connected at output of generator
Vertical: 1 kV/div
Sweep: 2 μ s/div

The ANSI/IEEE C62.41 Category B characteristics are 6 kV open-circuit voltage, 500 A short-circuit current, therefore a source impedance of $6000 : 500 = 12 \Omega$. From the circuit values of

Figure 54, the unknown effective impedance of the analyzer, Z , can be computed to be only 7Ω . That low impedance, when connected in parallel with the voltage measurement leads, will load the source of the transient and yield lower voltage recordings than the actual occurrence would have been without the analyzer connected. This situation makes the facetious remark in the 1970 paper come true (“the best surge suppressor is a surge monitor!”)*

While it is too late to correct data already recorded, there is a very simple solution to the problem. Ferroresonant line conditioners not only provide surge isolation at their output but also decoupling of the input from the output.⁽³⁰⁾ Figure 55 shows the open-circuit output of the surge generator at 6 kV (upper trace) and the output with the line conditioner feeding the analyzer plugged in (lower trace). There is no detectable effect on the impinging surge. Thus, by merely inserting the line conditioner in the power cord of the analyzer, the issue disappears, and measurements can be obtained without the ambiguity which can cause a sense of false security in the relatively low levels of impulse cited in some of the published reports.

7.8 Case History No. 8 – Varistor versus environment: Winning the rematch

During the initial startup of a solid-state motor drive in a chemical processing plant, difficulties arose with the varistor and its protective fuse at the input of the thyristor circuits. Frequent blowing of the fuse was observed, with occasional failure of the varistor. The plant substation, fed at 23 kV from the local utility, included a large capacitor bank with one-third of the bank switched on and off to provide power factor and system voltage regulation. These frequent switching operations were suspected of generating high-energy transients that might be the cause of the failure of the fuses and varistors, because literally thousands of similar drive systems have been installed in other locations without this difficulty.

On-site measurements performed after repeated blowing of fuses and occasional failure of varistors connected at the input to the thyristor drive indicated that indeed the devices were not matched to their environment. From this point on, specifying larger sizes, sizes appropriate to the environment, solved the problem. Immediate relief was secured by the installation of a larger varistor at the same point of the circuit; long-term protection was obtained by the addition of a gapless metal-oxide

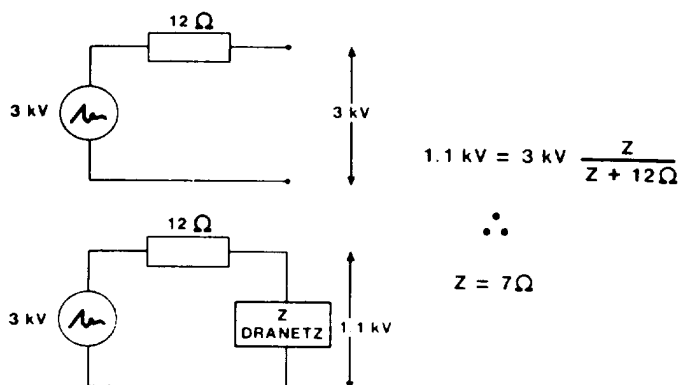

Figure 54. Computation of effective input impedance of the disturbance analyzer power supply

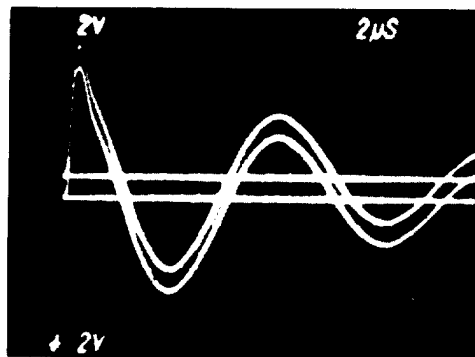

Figure 55. Output voltage of KeyTek 711/P1 surge generator

Top trace: No connected load

Lower trace:
Line conditioner
GE Cat 9T91L130G3
plugged in output

Vertical: 2 kV/div
Sweep: 2 μs/div

varistor arrester on the primary side of the step-down transformer feeding the drive. The situation has been changed from failures occurring every few days to no further problems in the 3 years since the larger varistor was installed. A complete description of this case history is given in Reference 8; a summary is given in this report.

This case history illustrates how surge protective devices that are successfully applied for the majority of cases can occasionally suffer failure when exposed to exceptionally severe surge environments. It also shows how little attenuation occurs, at the frequencies produced by switching surges, between the distribution level (23 kV) and

* Reference 19, p. 1055, conclusion of Case History No. 1.

the utilization level (460 V), even though a long line and two step-down transformers exist between the source of the transient and the point of measurement.

A typical total event recorded on one of the phases during a capacitor bank closing is shown in Figure 56A. A low-frequency oscillation with a period of 3 ms (330 Hz) and initial peak-to-peak amplitude of 450 V decayed in about 10 ms. The high-frequency oscillations are resolved in the recording of Figure 56B (recorded during a similar switching sequence). This high frequency has an initial peak-to-peak amplitude of 2000 V, decaying in about 5 ms. The period is 180 μ s (5.5 kHz). A similar, third event is shown in Figure 56C. For scaling the amplitudes, the steady-state voltage is shown in Figure 56D.

Figure 57 shows recordings of transient currents in all of the three varistors. Figure 57A shows a train of current pulses in the range of 10 to 40 A. In the burst of Figure 57B, the recorded current pulses range from 5 A to 200 A.

Conclusive evidence, therefore, was obtained that substantial current pulses were absorbed by the varistors during capacitor switching. The magnitude and duration of these pulses were excessive for the capability of a 20 mm disc used originally; many similar drives installed elsewhere do not experience the failures encountered at that particular location. Another significant finding from these measurements is the fact that the switching transients, generated at the 23 kV level, propagate down to the point of utilization at the 460 V level.

An obvious remedy would be to use a varistor with greater current-handling capability. The 32 mm size offers such a possibility. The improvement in the number of pulses is 50 times more pulses until *pulse rating* is reached. The improvement in the number of pulses until *varistor failure* occurs, however, is not necessarily 50 times more pulses. Because of the imprecision in the margin between end of pulse rating and ultimate failure, that margin is not necessarily the same for the two sizes, 20 mm and 32 mm, but it is reasonable to expect the same order of magnitude improvement in the ultimate failure as in the pulse rating. This expectation of a 50 times improvement would change the time between failures from the few days observed with the 20 mm size to perhaps 1 year with the 32 mm size, providing immediate relief and time to make

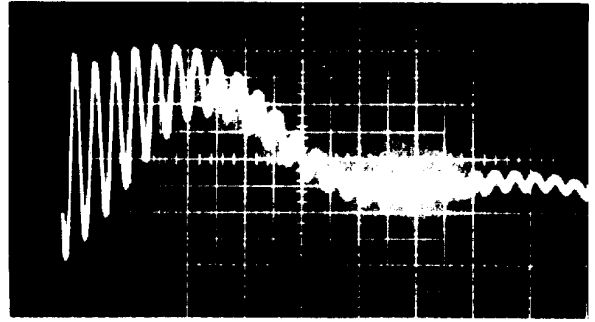

Figure 56. Capacitor switching transient
Vertical: 500 V/div
Sweep: 0.5 μ s/div

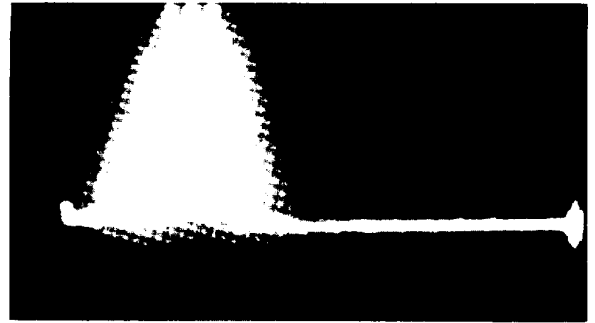

Figure 57. Current surge bursts during capacitor switching

further changes for the long term. Therefore, the change to a 32 mm size, connected at the same point of the circuit, was immediately implemented for that particular environment.

In addition to the proposed upgrading of protection at the 460 V level, three other remedies could be considered: installation of surge arresters at the 2300 V level, installation of surge arresters at the 23 kV level, or a change in the circuits involved in the capacitor switching, designed to reduce the severity of the transients at their origin. In a second phase of the retrofit described here, 2300 V arresters were installed at the transformer primary.

8. CONCLUSIONS

Power system disturbances can inject damaging overvoltages into power lines as well as data lines. Lightning surges can be equally damaging, by direct termination of a stroke, by induction, or especially, by differences in ground potential

caused by the flow of the current into earth. **Beware of differential ground potential rise!**

Fundamental precautions, best applied in the design and construction stages, can provide effective protection at a small cost compared to the alternative of failures and retrofits. **The cost of insurance premiums always seems high before the accident.**

Shielding, bonding, and grounding are the classical preventive methods at the system and component level. Conflicts between traditional grounding practices for noise reduction can be reconciled with the requirements of surge protection. **Grounding the shields at only one end invites trouble.**

A combined approach of fundamental precautions and protective devices can provide effective protection over the range of natural and man-made disturbances. However, these devices must be applied as part of a concerted effort. **The coordination of protective devices is the key to functional and cost-effective protection.**

9. ACKNOWLEDGMENTS

Motivation for preparing this report was provided by the reported case histories and the penetrating questions raised by students at the University of Wisconsin annual conferences on surge protection of computers and electronic systems, as well as by discussions with members of the IEEE Surge Protective Devices Committee. Maurice Tetreault of Digital Equipment Corporation graciously made available the recordings of transients on data cable. Virginia Barnum, Catharine Fisher, and Elizabeth Zivanov of Corporate Research and Development contributed valuable review and comments toward development of the final text.

REFERENCES

1. J.H. Hagenguth and J.G. Anderson, "Lightning to the Empire State Building," Part III, *AIEE Transactions* 71 PAS, August 1952.
2. N. Cianos and E.T. Pierce, *A Ground Lightning Environment for Engineering Usage*, Stanford Research Institute Technical Report, August 1972.
3. R.H. Golde, "The Frequency of Occurrence and the Distribution of Lightning Flashes to Transmission Lines," *AIEE Transactions* 64, 1945.
4. *World Distribution of Thunderstorm Days*, WMO-OMM #21 TP6, World Meteorological Organization, Geneva, 1953.
5. R.H. Golde, "The Lightning Conductor," *Lightning II*, R.H. Golde, ed., Academic Press, New York, 1977.
6. H. Cavendish, W. Watson, B. Franklin, and J. Robertson, "Report of the Committee Appointed by the Royal Society to Consider a Method of Securing the Powder Magazines at Purfleet," *Philosophical Transactions of the Royal Society* 63, London, 1773, and 68, 1777.
7. A. Greenwood, *Electrical Transients in Power Systems*, Wiley Interscience, New York, 1971.
8. F.D. Martzloff, *Varistor Versus Environment: Winning the Rematch*, 85CRD037, General Electric Company, Schenectady, New York, 1985.
9. D.W. Bodle, et al., *Characterization of the Electrical Environment*, University of Toronto Press, Toronto, Canada, 1976.
10. E. Bennison, D. Ferland, and A.J. Ghazi, "Lightning Surges in Open-Wire, Coaxial, and Paired Cables," *Proc. of the IEEE International Conference on Communications*, June 1972.
11. C.F. Boyce, "Protection of Telecommunications Systems," in *Lightning 2*, R.H. Golde, ed., Academic Press, New York, 1977.
12. R.L. Carroll and P.S. Miller, "Loop Transients at the Customer Station," *Bell System Technical Journal* 59 (9), pp. 1609-1643, November 1980.
13. R.L. Carroll, "Loop Transient Measurements in Cleveland, South Carolina," *Bell System Technical Journal* 59 (9), pp. 1630-1645, November 1980.
14. M. Tetreault and F.D. Martzloff, "Characterization of Disturbing Transient Waveforms on Computer Data Communication Lines," *Proc. of the 6th Symposium on Electromagnetic Compatibility*, Zurich, pp. 423-428, 1985.
15. *Guide for Surge Withstand Capability (SWC) Tests*, ANSI Std C37.90a, 1974; IEEE Std 472-1974.
16. *Insulation Coordination Within Low-Voltage Systems Including Clearances and Creepage Distances for Equipment*, International Electrotechnical Commission Report 664, 1980.
17. *IEEE Guide for Surge Voltages in Low-Voltage AC Power Circuits*, ANSI/IEEE Std C62.41-1980.

18. J.E. Lenz, "Basic Impulse Insulation Levels of Mercury Lamp Ballast for Outdoor Applications," *Illumin. Eng.*, pp. 133-140, February 1964.
19. F.D. Martzloff and G.J. Hahn, "Surge Voltage in Residential and Industrial Power Circuits," *IEEE Transactions on Power Apparatus and Systems PAS 89 (6)*, pp. 1049-1056, July/August 1970.
20. R. Hasler and R. Lagadec, "Digital Measurement of Fast Transients on Power Supply Lines," *Proc. 3rd Symposium and Technical Exhibition on Electro-Magnetic Compatibility*, Rotterdam, Holland, pp. 445-448, May 1979.
21. H. Wernström, M. Bröms, and S. Boberg, *Transient Overvoltages on AC Power Supply Systems in Swedish Industry*, National Defence Research Institute, Linköping, Sweden, 1984.
22. P. Chowdhuri, "Transient Voltage Characteristics of Silicon Power Rectifiers," *IEEE Transactions on Industry Applications IA-9*, September/October 1973.
23. P. Richman, "Changes to Classic Surge Test Waves Required by Back Filters Used for Testing Powered Equipment," *Proc. of the 6th Symposium on Electromagnetic Compatibility*, Zurich, pp. 413-418, 1985.
24. *IEEE Standard Test Specifications for Gas Tube Surge-Protective Devices*, ANSI/IEEE C62.31-1981.
25. *IEEE Standard Test Specifications for Low-Voltage Air Gap Surge-Protective Devices (Excluding Valve and Expulsion Type Devices)*, ANSI/IEEE C62.32-1981.
26. *IEEE Standard Test Specifications for Varistor Surge-Protective Devices*, ANSI/IEEE C62.33-1982.
27. *IEEE Standard Test Specifications for Avalanche Junction Semiconductor Surge-Protective Devices*, IEEE C62.34-1984.
28. Martzloff, F.D., Discussion of paper "Rural Alaska Electric Power Quality," *IEEE Transactions on Power Apparatus and Systems PAS-104*, No. 3, pp. 618-619, March 1985.
29. F.D. Martzloff and H.A. Gauper, *Surge and High Frequency Propagation in Industrial Power Lines*, 85CRD087, General Electric Company, Schenectady, New York, 1985.
30. F.D. Martzloff, "The Propagation and Attenuation of Surge Voltages and Surge Currents in Low-Voltage AC Circuits," *IEEE Transactions on Power Apparatus and Systems, PAS-102*, pp. 1163-1170, May 1983.
31. *Transient Voltage Suppression Manual*, Fourth Edition, General Electric Company, Syracuse, New York, 1983.
32. J.D. Harnden, F.D. Martzloff, W.G. Morris, and F.B. Golden, "The GE-MOV Varistor - The Super Alpha Varistor," *Electronics* 45 (21), p. 91, 1972.
33. G.D. Mahan, L.M. Levinson, and H.R. Philipp, *Theory of Conduction in ZnO Varistors*, 78CRD205, General Electric Company, Schenectady, New York, 1978.
34. M. Matsuoka, T. Masa Yama, and Y. Lida, "Nonlinear Electrical Properties of Zinc Oxide Ceramics," *Proc. of First Conf. Solid State Devices*, Tokyo, 1969, *J. Japan Soc. Appl. Phys.* 39, 1970, Suppl., 94.
35. M. Matsuoka, "Non-Ohmic Properties of Zinc Oxide Ceramics," *Jpn. J. Appl. Phys.* 10, p. 736, 1971.
36. Alexander Kusko, Inc., "Evaluation of Transient Voltage Suppressors for Saving Electric Energy," Electric Power Research Institute Report EM-1722, Palo Alto, California, 1981.
37. *Standard for Voltage Surge Suppressors, UL 1449*, Underwriters' Laboratories, 1985.
38. K.E. Crouch, Lightning Technology, Inc., Pittsfield, Massachusetts, private communication.
39. *National Electrical Code*, National Fire Protection Association, Boston, Massachusetts.