

# Coupling, Propagation, and Side Effects of Surges in an Industrial Building Wiring System

François D. Martzloff  
National Institute of Standards and Technology  
Gaithersburg MD  
f.martzloff@ieee.org

Reprinted, with permission, from *IEEE Transactions on Industry Applications IA-26*, March/April 1990  
First presented at the IEEE-IAS Annual Meeting, Pittsburgh, 1989

## **Significance:**

### Part 4 – Propagation and coupling of surges

The paper reports a rare opportunity for injecting surges in a full-size building, before and after it became populated with manufacturing and information technology equipment. The surges, of the unidirectional type or the ring-wave type described in ANSI/IEEE Standard C62.41-1980, were injected at one point of the system and the resulting surges arriving at other points were measured.

The results show how unidirectional surges couple through transformers and can produce a ring wave component in the response of the system. Once again, it was observed that even in this relatively large building, a 40-m long branch circuit produces the transmission line reflection effect of an open-ended line only on the front part of the 0.5  $\mu\text{s}$  – 100 kHz ring wave. (At 200 m/ $\mu\text{s}$  propagation speed, the travel time for a 40-m long line is only 0.2  $\mu\text{s}$ .)

Limited tests on the injection of the 5/50 ns EFT burst verified again the loss of steepness in the front of a nominal 5 ns arriving as a 100 ns front after traveling along 95 m of branch circuits. (See pdf files “Propagation EFT1 1987” and “Propagation EFT2 1990” in this Part 4.)

An unexpected side effect of these surges, applied to the power lines only, was the apparent damage suffered by the data line input components of some computer-driven printers. That particular finding became significant in developing the concept of “surge reference equalizers” – a surge protective device through which both power wires and data wire are routed, also more recently known as “multi-port surge protector.”

# Coupling, Propagation, and Side Effects of Surges in an Industrial Building Wiring System

FRANÇOIS D. MARTZLOFF, FELLOW, IEEE

**Abstract**—Measurements were made in an industrial building to determine the propagation characteristics of surges in the ac power wiring of the facility. The surges, of the unidirectional type or the ring-wave type described in ANSI/IEEE Standard C62.41-1980, were injected at one point of the system and the resulting surges arriving at other points were measured. The results show how unidirectional surges couple through transformers and produce a ring wave component in the response of the system. An unexpected side effect of these surges, applied to the power lines only, was the apparent damage suffered by the data line input components of some computer-driven printers.

## INTRODUCTION

PREVIOUS MEASUREMENTS have been reported on the propagation of surges in the lines used for industrial and residential power systems. These measurements were made in the laboratory on a point-to-point line, isolated from the building wiring system or grounds. These measurements indicate little attenuation of slow-front surges as they propagate along the line [1], [2]. In contrast, the propagation of the fast-front surges follows the behavior expected from classical transmission line analysis [3]–[5]. For fast-front surges, the amplitude changes at interfaces where an impedance mismatch exists. The difference between slow and fast is relative and is only a way to relate the duration of the surge rise time to the travel time of the surge along the line. In the wiring of an actual building, the configuration is more complex, involving multiple branch circuits, transformers, and changing loads.

An opportunity arose to perform new surge propagation measurements during two stages of a new building project: before any loads were connected, and after the owner had moved in and various loads had been installed in the building. Surges representative of the types encountered in low-voltage power circuits were injected at various points of the wiring system. The resulting surges appearing at other points of the system were measured and synchronized with the injected surges by several disturbance monitors, in conjunction with two storage oscilloscopes. The results of these measurements give new insights on the coupling of surges into other parts of the wiring system not directly connected to the part being surged, as well as on their propagation along the various branch circuits in the building. Some of the more important

Paper IPCSD 88-24, approved by the Power Systems Engineering Committee of the IEEE Industry Applications Society for presentation at the 1988 Industry Applications Society Annual Meeting, Pittsburgh, PA, October 2–7. Manuscript released for publication May 11, 1989.

The author is with the National Institute of Standards and Technology, Building 220, Room B344, Gaithersburg, MD 20899.

IEEE Log Number 8932121.

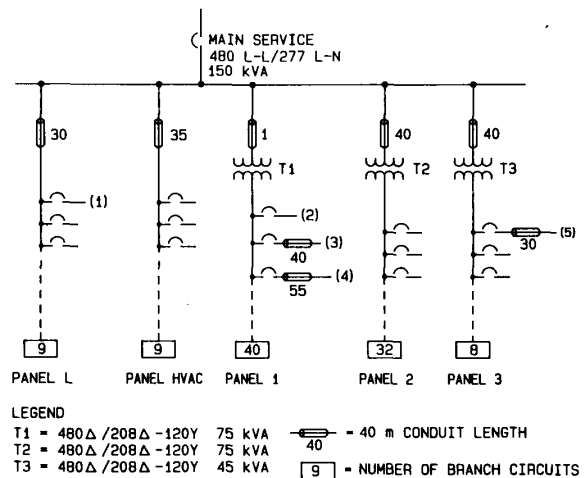

Fig. 1. Simplified one-line diagram of building power wiring.

findings will be described:

- coupling of the surges through the system stepdown transformers;
- conversion of unidirectional surges into oscillatory surges;
- propagation of the surges in branch circuits;
- difference in the propagation of fast-front versus slow-front surges;

(these four types of measurements were the intended prime objective); and

- measurement of the coupling into adjacent but not connected wiring;
- anecdotal discussion of component failures in data ports of printers during surge tests on the power lines.

## EXPERIMENTAL PROCEDURE

### Building Power System

Fig. 1 shows a simplified one-line schematic of the building power system. Three-phase service is provided at the 480/277-V level by a step-down transformer outside the building. A 480/277-V bus provides power directly to a lighting panel and a heating-ventilation-air-conditioning panel. Other loads in the building are supplied at 208/120 V through three transformers, each with a distribution panel feeding the individual branch circuits. Special efforts were

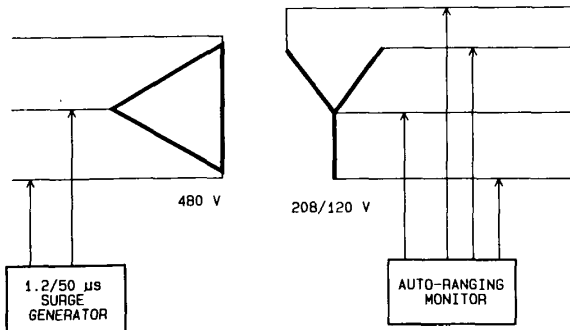

Fig. 2. Coupling of surge through delta-wye step-down transformer.

made during the construction to record the actual length of the branch circuits for accurate documentation of the system.

Surges were injected and measured at various points on the system that were accessible at the panels or at the end of branch circuits. The resulting surges arriving at other points of the system were measured simultaneously with the injected surge, to characterize the propagation of the surges. These points of injection (sending end) and arrival (receiving end) are shown by the numbers in parentheses in Fig. 1. The length of conduit between the panel and the end of the branch circuit is also shown in the figure. These numbers will be used in describing the various configurations of the tests reported in this paper.

### Instrumentation

Three types of instruments were used in the tests:

- a surge generator capable of delivering either the 1.2/50–8/20- $\mu$ s combined surge or the 100-kHz ring wave, as described in [6], [7];
- storage oscilloscopes for monitoring the surge at the sending end and at the receiving end;
- disturbance monitors with auto-ranging and graphic output capability.

A complete description of the instruments and the surge coupling method is given in the Appendix, together with some practical suggestions on making field tests.

### Test Schedule

Widely varying configurations were explored; those reported here are the most illustrative of the propagation characteristics of typical surges in this typical installation. The tests were performed in two phases: first when the building was unoccupied, so that a no-load condition existed; and second, with the building operational and under representative loading conditions. Two types of surges were applied:

- a 1.2/50- $\mu$ s unidirectional surge representative of a conventional lightning surge, applied to the service entrance and impacting the whole building;
- a 100-kHz ring wave representative of a conventional switching surge, applied at some point of the building and propagating in the system, for each of various combinations of the connected loads.

## MEASUREMENT RESULTS

### Unidirectional Surge Propagation

The unidirectional 1.2/50- $\mu$ s surge is generally considered representative of lightning surges on the incoming service entrance [6], [8]. A scenario equivalent to having such a surge impinge on the building was created by injecting the surge at an accessible point (1) of the lightning panel *L* in Fig. 1. From that point, the surge propagated to the 480-V bus, through the 480/208 V transformers, to the distribution panels and the branch circuits. In a first set of measurements, the surge arriving at point (2) of the panel fed by transformer T1 was recorded for a surge injected at point (1). These measurements were made at the initial stage, in the empty building, before any of the load equipment was connected.

The surge was injected between two lines on the primary side and coupled to the corresponding line-to-neutral pair of lines on the secondary side of the 480/208-V delta-wye transformer (Fig. 2). To find which of the three secondary phases is coupled to the primary phase of surge injection, the auto-ranging disturbance monitor was connected to all three phases on the secondary side.

Fig. 3 shows the graphic display obtained with that instrument. Phase *B* has the highest amplitude and thus corresponds to the direct coupling on one leg of the transformer. Phases *A* and *C* correspond to the coupling by the two other legs of the transformer, effectively connected in series on the delta-coupled primary side. Note how the auto-ranging feature of the instrument changes the time scale of the graphics to display a longer time sweep for phase *B*, where the disturbance remains high for a longer time than for the smaller disturbances on phase *A* and *C*. The direct coupling path having been identified, the storage oscilloscope used for the recordings of Figs. 4–7 was then connected across phase *B*. One probe was connected to the line conductor, the other to the neutral conductor. A differential connection was thus obtained, according to the recommended practice for surge measurements [9].

Figs. 4 and 5 show the recordings for a circuit condition with minimum wiring connected to the 480-V bus. Only breakers at points (1) and (2) in Fig. 1 are closed on panels *L* and 1. Transformers T1, T2, and T3 have their primaries connected to the 480-V bus, but their secondaries are connected only to input lugs of the distribution panels. With the main service circuit breaker open, the utility connection is severed.

In Fig. 4, a 600-V 1.2/50- $\mu$ s surge is generated and injected at point (1) (Fig. 1). In this configuration, the connection from the lightning panel is used as an equivalent to the service entrance connection for bringing the surge to the 480-V bus. Fig. 4(a) shows the open-circuit voltage of the surge generator before connection to the sending end point (1). Fig. 4(b) shows the voltage recorded at point (1), indicating interaction between the surge generator and the circuit under test. Fig. 4(c) shows the voltage recorded at the receiving end point (2), where the unidirectional surge has acquired an oscillatory component. This conversion of a unidirectional surge into an offset oscillatory wave illustrates the basis for introducing the concept of ring waves into [6].

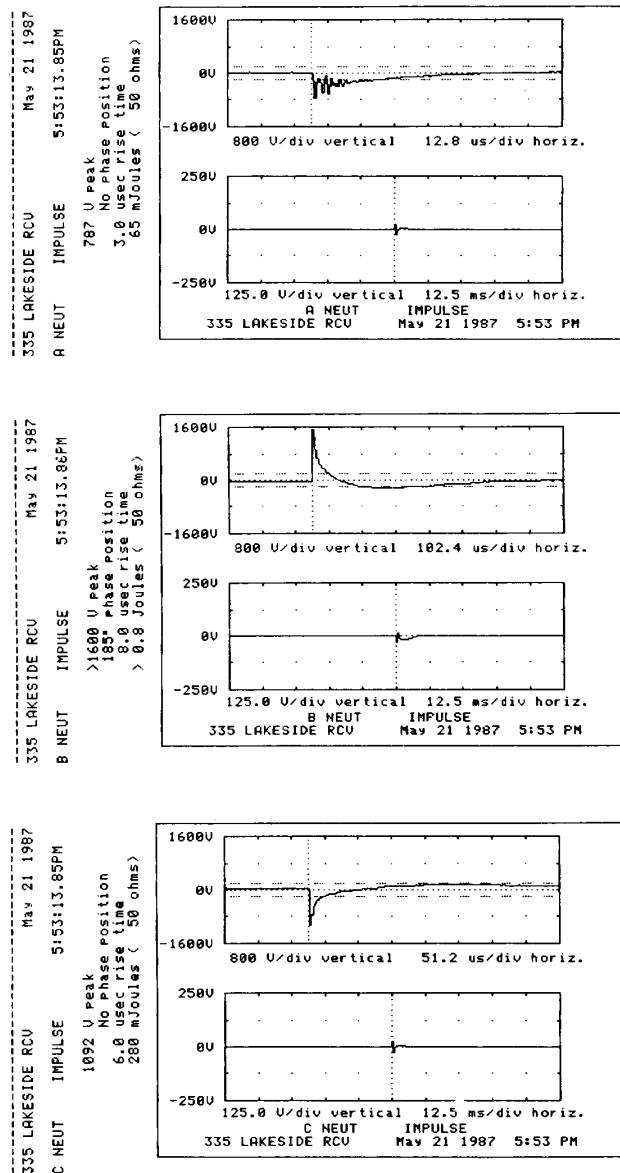

Fig. 3. Graphic display of surges on three phases at receiving end (2). Note highest impulse on phase B, indicating direct coupling, and auto-ranging of two sweep rates.

Fig. 5 shows the recordings at the sending end and at the receiving end for an open-circuit voltage setting of 3000 V by the surge generator. A comparison of Figs. 4 and 5 yields interesting results. First, on a qualitative basis, the voltage at the receiving end in both cases contains a unidirectional component with superimposed oscillation. A line has been marked on the oscillograms to show the unidirectional component at the center of the oscillation.

Second, quantitative inspection of the results yields further insight into the coupling of the surge through the transformer. For the 600-V sending-end condition (Fig. 4), the resulting unidirectional component is 150 V, or a 4:1 ratio, which is

precisely the 480/120 turns ratio of the step-down transformer. For the 3000-V sending-end condition (Fig. 5), the unidirectional component is 750 V, again a 4:1 ratio. This constant ratio demonstrates the linearity of the transformer in coupling unidirectional surges over a 5:1 range of overvoltages.

The response of the combined transformers T1, T2, and T3, and the 480-V bus is a 370-kHz ringing overshoot, peaking, respectively, at 380 V (Fig. 4) and at 1900 V (Fig. 5). The corresponding overshoot ratios are  $380/150 = 2.53$  and  $1900/750 = 2.53$ , again showing the linearity of the response. Thus tests for propagation only (no nonlinear protective devices in the system) could be performed at low surge

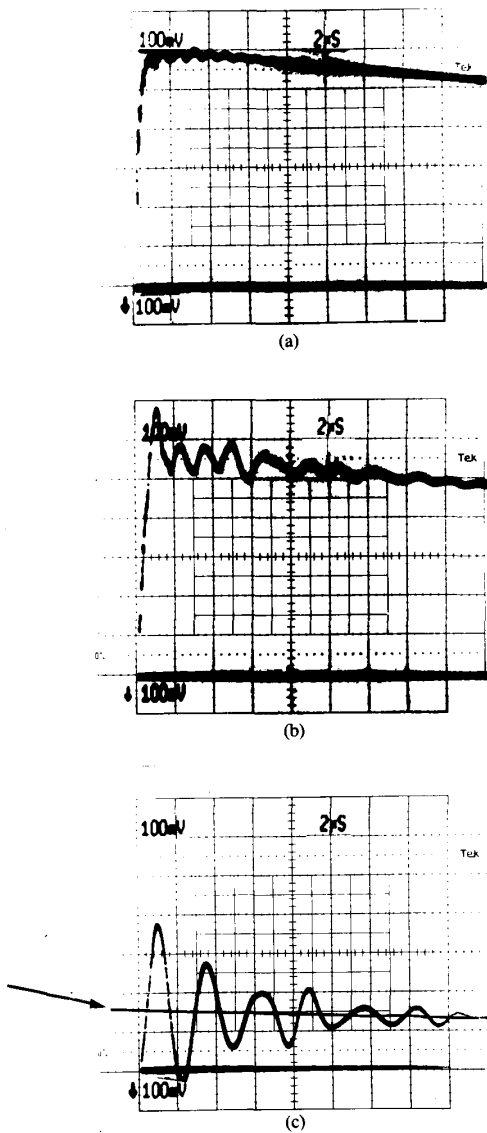

Fig. 4. Recordings at sending end (1) and receiving end (2), for 600-V unidirectional surge. Minimum wiring connected 480-V bus (breakers to 277 V branch circuits and 120 V branch circuits open). Voltage: 100 V/div; sweep: 2  $\mu$ s/div. (a) Open-circuit output of surge generator. (b) Voltage at sending end. (c) Voltage at receiving end. Note line showing unidirectional component.

voltages and produce valid results for higher surges. However, interest in evaluating the effects of surge-protective devices was a motive for making further tests with relatively higher surge levels. This paper, however, is primarily concerned with the propagation aspects. Surge-protective devices will be fully discussed in a later paper.

Figs. 6 and 7 show the recordings, for the same injected unidirectional surge, when more of the wiring system is connected to the circuit under test, with the system still isolated from the utility supply. In the test illustrated by Fig. 6, lighting circuits were connected. Although the fluorescent lights were not operating, the built-in capacitors of the ballasts

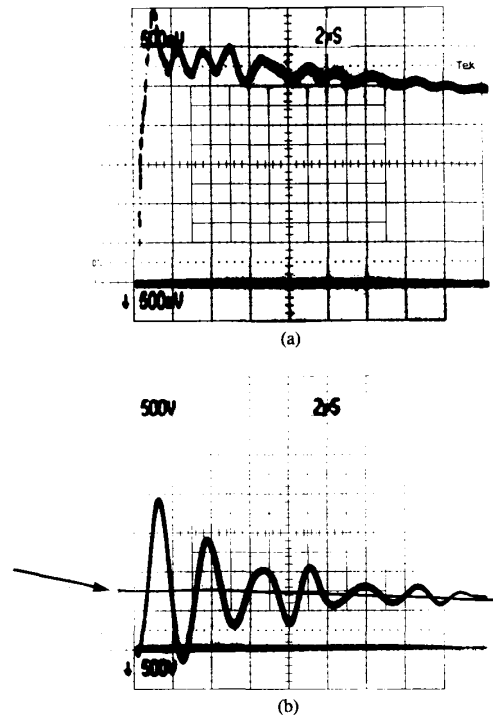

Fig. 5. Recordings at sending end (1) and receiving end (2), for 3-kV unidirectional surge. Minimum wiring connected 480-V bus (all breakers to 277 V branch circuits and 120 V branch circuits open). Voltage: 500 V/div; sweep: 2  $\mu$ s/div. (a) Voltage at sending end. (b) Voltage at receiving end. Note line showing unidirectional component.

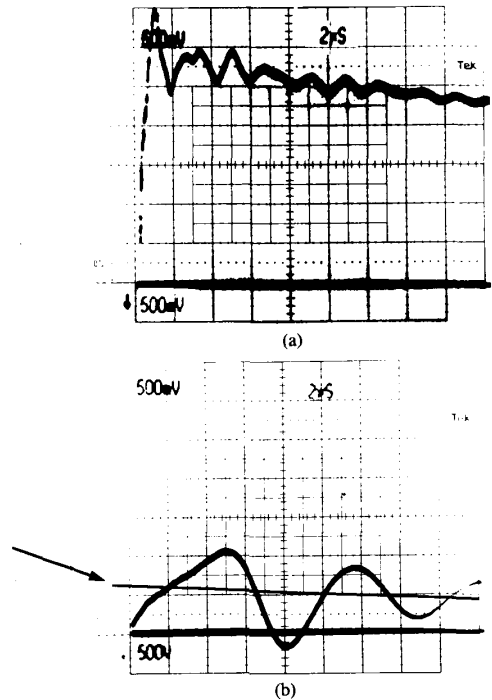

Fig. 6. Recordings at sending end (1) and receiving end (2), for 3-kV unidirectional surge. All 277-V lighting branch circuits connected to 480-V bus. Voltage: 500 V/div; sweep 2  $\mu$ s/div. (a) Voltage at sending end. (b) Voltage at receiving end. Note line showing unidirectional component.

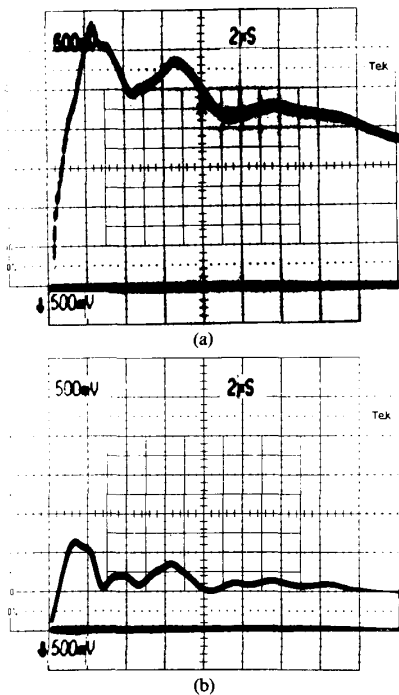

Fig. 7. Recordings at sending end (1) and receiving end (2), for 3-kV unidirectional surge. All 120-V branch circuits connected to 480-V bus through three 480/208-120-V step-down transformers. Voltage: 500 V/div; sweep 2  $\mu$ s/div. (a) Voltage at sending end. (b) Voltage at receiving end.

were effectively added to the circuit. At the receiving end, a unidirectional component of 700 V with a 150-kHz ringing overshoot with a ratio of about 1.25 can be observed.

In the test illustrated by Fig. 7, all of the circuit breakers at panels 1, 2, and 3 of Fig. 1 were closed, adding the corresponding branch circuits, but without loads at the receptacles. The response at the receiving-end, point (2) in Fig. 1, still shows a unidirectional component of 700 V, but the ringing overshoot is now quickly damped out.

These three circuit conditions illustrate the wide range of ring waves that occur when a wiring system is stimulated by a unidirectional surge. The general prevalence of ring waves in building wiring systems was confirmed by these initial tests, so that most of the other tests were made with the 100-kHz ring wave.

#### Ring-Wave Surge Propagation

Further measurements were made with the ring waves injected at the sending-end, point (3) in Fig. 1. Arriving surges were recorded at the receiving-end, point (4). This scenario corresponds to a surge being generated by some equipment within the building, or the surge resulting from system stimulation by lightning. A few measurements were also made to investigate propagation from point (3) to point (5), to illustrate coupling through two cascaded wye-delta and delta-wye transformers, but these did not produce remarkable results.

The ring wave used for these measurements is defined in [7]; Fig. 8 shows the open-circuit voltage of a generator

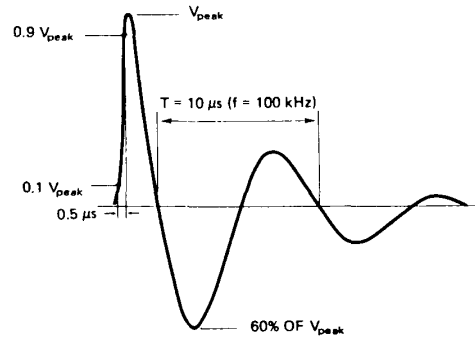

Fig. 8. 0.5  $\mu$ s-100 kHz ring wave defined in [6].

producing such a wave. The use of a 100-kHz ring wave with a 0.5- $\mu$ s rise time for the tests introduces an additional parameter: the reflections at the ends of the lines become significant for the lengths of some branch circuits found in this building. For a velocity of propagation on the order of 200 m/ $\mu$ s, a length of line greater than 50 m means a travel time longer than the rise time of the surge, so that reflections become significant [2].

The measurements covered a series of tests; the propagation path between the sending and receiving ends was progressively modified. Starting with simple point-to-point configurations, branch circuits were added by closing all breakers at Panel 1, connecting the secondary of transformer T1, and terminating the line at point (4) with various loads.

Figs. 9, 10, and 11 show typical recordings for three of these configurations. Fig. 13 will present a summary of the various configurations with resulting propagation characteristics for the ring wave, after first discussing in detail the features of the three recordings of Figs. 9-11.

#### Simple Line from Point to Point

For the case of Fig. 9, no breakers other than 2, 3, and 4 are closed at Panel 1; the configuration is a simple point-to-point line from point (3) to (4). Fig. 9(a) is the recording at the sending end, located 40 m from Panel 1. The waveform shows the interaction occurring between the surge generator and the wiring system. Fig. 9(b) shows the recording at intermediate point (2) and presents some interesting features, as follows.

1) The initial peak of 1100 V at the sending end has been attenuated to 750 V, a ratio of 0.68, after 40 m of travel from point (3) to point (2).

2) A second peak is visible, about 0.6  $\mu$ s after the first: the pulse arriving at the open end of point (4) is reflected with twice the amplitude and travels back toward Panel 1. It arrives at Panel 1 after a  $2 \times 55$ -m travel, requiring about 0.6  $\mu$ s for the round trip at a velocity of 200 m/ $\mu$ s; this expected time matches the time observed between the two peaks.

3) The returned pulse, arriving at Panel 1 after 110 m round-trip travel in the line, has lost some of its higher frequency components [3] and is less sharp than that coming from the sending point.

4) The returned pulse travels further back to sending point (2), where it arrives to produce a discontinuity in the trace visible at the first zero crossing of the trace in Fig. 9(a).

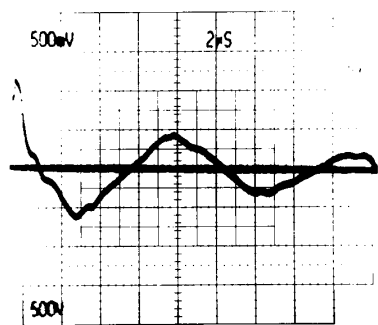

(a)

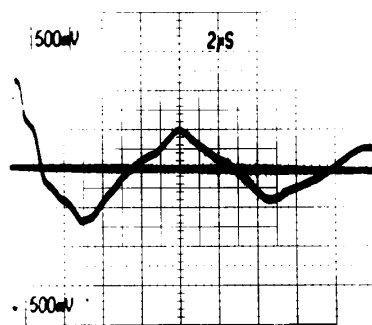

(a)

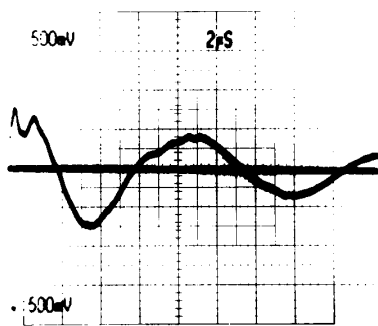

(b)

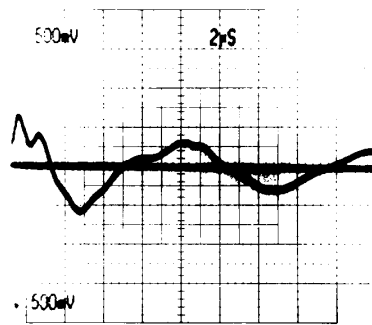

(b)

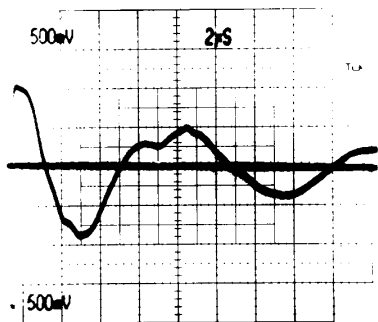

(c)

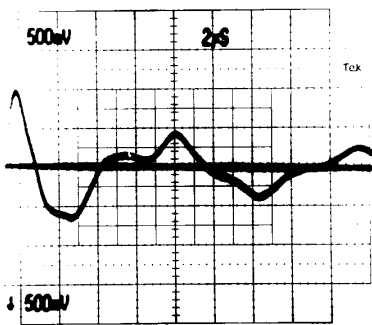

(c)

Fig. 9. Recordings at sending end (3), intermediate point (2) of Panel 1, and receiving end (4) for 100-kHz ring wave and point-to-point propagation in simple line. No additional branch circuits have been connected between points (3) and (4). Voltage: 500 V/div; sweep: 2  $\mu$ s/div. (a) Voltage at sending end. (b) Voltage at Panel 1. (c) Voltage at receiving end.

5) The second peak of the ring wave (negative peak) and the third peak (positive peak) do not show very significant changes in amplitude among the three oscillograms. These peaks do not contain the high-frequency components associated with the initial fast rise, and thus are not significantly attenuated by the 40- or 95-m travel along the line.

Finally, Fig. 9(c) shows the initial peak, which traveled 95 m from the point of origin and, therefore, might be expected to have been attenuated about twice as much as between points (3) and (2), a 40-m travel. (The attenuation is not quite proportional to distance, as the higher frequency components suffer greater attenuation in the early parts of the

Fig. 10. Recordings at sending end (3), intermediate point (2) of Panel 1, and receiving end (4) for 100-kHz ring wave. Transformer T1 is connected at Panel 1 and supplies power to branch circuits 3 and 4. Voltage: 500 V/div; sweep 2  $\mu$ s/div. (a) Voltage at sending end. (b) Voltage at Panel 1. (c) Voltage at receiving end.

travel; the waveform contains fewer of them, and is therefore less attenuated in the end parts of the travel [4].) The expected amplitude of the attenuated pulse arriving at point (4) should be about 1100 V, the initial value, attenuated by about two times (twice the distance) the 0.68-ratio noted between points (3) and (2):  $1100 \times 0.68^2 = 510$ . The oscillogram shows, on the contrary, a 1050-V peak, or close to twice the expected arriving pulse value—the doubling effect at the open-ended transmission line.

To summarize the observations from Fig. 9 data, the first peak, with a duration shorter than the travel time in the line, exhibits all the behavior of pulses traveling in a transmission line. Later peaks, with durations longer than the travel time,

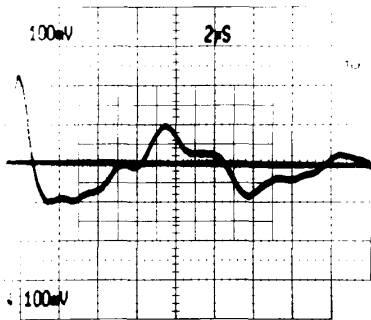

Fig. 11. Recording at receiving end point (4) for 100-kHz ring wave. Transformer T1 is connected at Panel 1 and supplies power to all loads connected to branch circuits of that panel. Voltage: 100 V/div; sweep: 2  $\mu$ s/div.

exhibit little attenuation for the 40- and 95-m travel distances in this building.

#### Adding Complexity to the System

Fig. 10 shows the recordings at the same three points discussed for Fig. 9 but with transformer T1 connected to Panel 1 and supplying power to that panel. All other branch circuits of that panel are still left disconnected.

Fig. 10(a) shows the sending end to be little different from Fig. 9(a), except that later reflections have modified subsequent peaks. Fig. 10(b) shows again the double peak at Panel 1, resulting from the initial pulse arriving from the sending end, followed by a reflected pulse coming back from the receiving end. Fig. 10(c) shows the initial pulse arriving at the receiving end, doubled by the effect of the open-ended line in the same manner as discussed for Fig. 9(c). The same conclusions as those drawn from Fig. 9 apply here: the initial peak behaves as a pulse in a transmission line, and subsequent peaks are not significantly attenuated. The inspection of subsequent peaks is no longer as simple as it was for Fig. 9, because with the added elements in the transmission path, the cumulative effect of the reflections distorts these peaks.

One further stage in the reconstitution of the building wiring system is illustrated by Fig. 11, where all branch circuits at Panel 1 are now connected, supplying their normal loads with power obtained from transformer T1, which is energized. For the same ring wave of 1100 V applied at the sending end, point (3) in Fig. 1, the first peak at the receiving end, point (4), is only 220 V, down from the 1000 V of Fig. 10. This large drop is caused by the impedance mismatch resulting from connecting the many parallel transmission lines at Panel 1. Even the subsequent peaks show a reduction (down to 100 V from the 400 V of Fig. 10), but the waveform is so distorted by the cumulative effect of the multiple reflections that a simple analysis by inspection is no longer possible. Computer modeling might be an interesting task for specific cases where a rigorous prediction would be of interest [10], [11].

Summarizing now all the observations from the ring-wave measurements, three major conclusions emerge.

1) In a building with no or few loads, fast-front surges propagate in a manner that can be readily predicted by classical transmission line analysis.

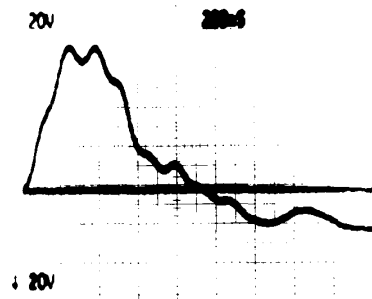

Fig. 12. Recording at receiving end point (4) for fast-front surge, injected at sending end (3) by generator with 5 ns nominal rise time.

2) Adding many parallel branch circuits produces amplitude reductions, predictable by the impedance mismatch at the point of parallel connections.

3) Surges having durations longer than the travel time within the building propagate with very little attenuation for a relatively simple configuration. In a building of complex configuration, cumulative effects of reflections from branch circuits with random lengths tend to reduce subsequent peaks by averaging out their interaction. This observation, however, leaves open the possibility of a random combination that could enhance subsequent peaks, or at least not reduce them by the averaging effect.

#### Propagation of Fast Transients

The unplanned availability of a surge generator having a rise time of a few nanoseconds made possible incidental tests of the propagation of fast transients in the building. However, suitable probes were not available to record accurately the fast rise time at the sending end. Only the receiving-end surges could be observed with confidence, because the rise time observed there was indeed longer than the response time of the probes. For a nominal 5-ns rise time available at the generator output and injected at the sending end, point (3), the rise time observed at the receiving end, point (4), was 100 ns (Fig. 12). This increase in rise time confirms the findings reported earlier in [4] and [5]. This observation also confirms that concerns over the presence of surges with rise times of a few nanoseconds are not generally applicable to power systems for locations remote from the source of the fast transients [12].

#### Summary of Ring Wave Propagation

Fig. 13 presents a summary of the attenuation observed for various configurations of the building wiring. The many values obtained show how difficult a prediction would be for a complex system, but such data are helpful in providing some upper and lower bounds. In this figure, the transmission path is represented by a branch circuit from the sending end (left line) to Panel 1 (box at center) and an emerging branch circuit to the receiving end (right line).

From the top to the bottom of Fig. 13, various combinations of added circuits are shown at Panel 1 and at the receiving end, labeled A through K. The numbers shown at the right of each configuration, A through K, are the observed values at the receiving end. For the first column, the numbers are the value



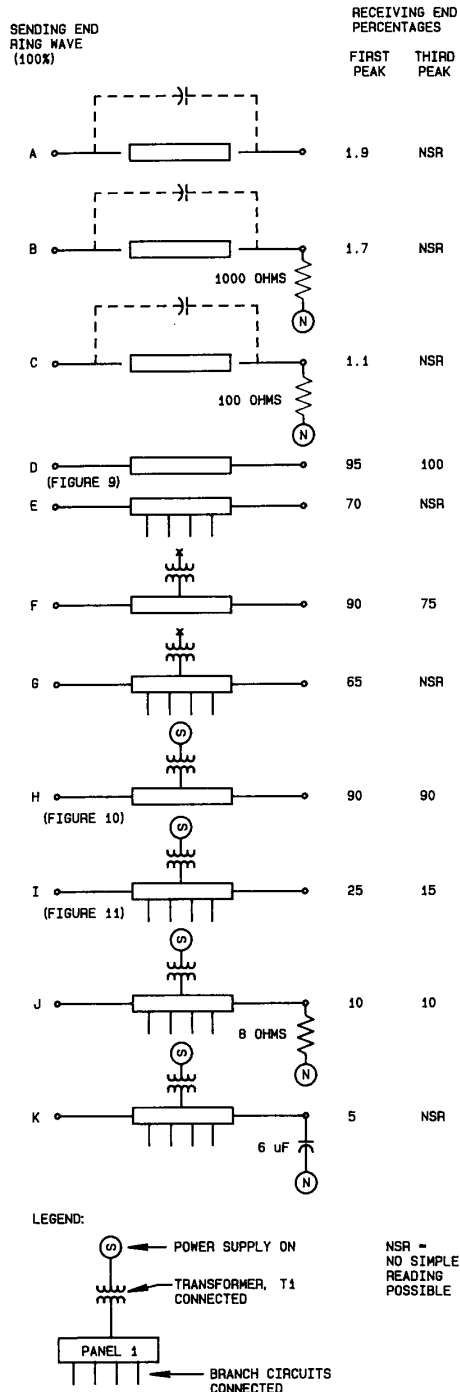

Fig. 13. Schematic representation of configurations for propagation path from sending end (3) to receiving end (4). Numbers at right are receiving-end percentages of first and third peaks of arriving surges for ring wave of 100 percent applied at sending end.

of the first peak; for the second column, the numbers are the value of the third peak (second positive peak of the ring wave). These numbers are given as percentages of the sending-end values of the first peak. In some cases, the response of the circuit was so complex that no simple reading could be made at

the time of the third peak, hence the entry "NSR" in the second column.

Configurations *A*, *B*, and *C* show *all* breakers open at Panel 1, so that no direct metallic connection exists between the sending and receiving ends. However, the proximity of the wires in common conduits shared for part of the distance is sufficient to couple some of the surge by the stray capacitance. Adding load at the receiving end between the line and the neutral (configurations *B* and *C*) provides a measure of the transfer impedance of that coupling.

Configurations *D* to *G* show increasing complexity in the transmission path, with added branch circuits at Panel 1 *E*, added transformer *F*, and both added *G*, but still no power applied to the primary of the transformer. For configurations *H* to *K*, the transformer primary is energized, supplying power to Panel 1 and its loads. In *H*, only the transformer is connected; in *I* the branch circuits have been added. In *J* and *K*, two different types of loads have been connected at the receiving end, between line and neutral, to show how a low-impedance termination reduces the reflections observed with higher impedance terminations.

#### SIDE EFFECTS

An unexpected side effect of the surges was found only upon the resumption of normal weekly operations, after the tests (which were performed on a weekend). Two laser printers shared by several personal computers and thus linked by a data cable had become inoperative. Repair by the service organization of the manufacturer diagnosed failed components in the *data line port* of the printer. Yet, all the surges had been injected into the *power lines*, and at levels initially deemed high but not hazardous to equipment designed for connection to typical ac power systems.

The exact nature of the failure is unknown because the service organization performed repairs as a routine operation, not associated with this surge measurement project, and its repair records were not available. However, with hindsight, this side effect might well be explained by the following hypothetical, but plausible scenario. (Anecdotal information on problems encountered at other facilities indicates that this type of problem is not at all unusual. A detailed description of a scenario that could lead to this failure of information technology systems should be useful for understanding the problem—a first step toward avoiding it in the future.)

Many applications of information technology equipment require that peripheral terminal devices (video displays, data entry keyboards, printers) be located at some distance from the computer. Frequently, terminal devices are powered by a line cord plugged into a wall receptacle which is on a different branch circuit from that of the computer. Sometimes, the branch circuits are supplied by different transformers (Fig. 14). This situation produces multiple ground references and loops of communication cables, with the possibility of substantial differences in the potentials of points expected to be at the same zero-reference potential.

The general practice is to have the device chassis bonded to the grounding conductor of the power cord. Also as a general practice, the zero reference of the signal circuit is bonded to

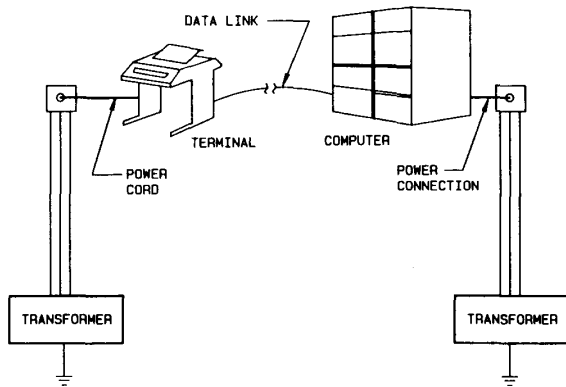

Fig. 14. Typical arrangement for powering computer and its peripherals.

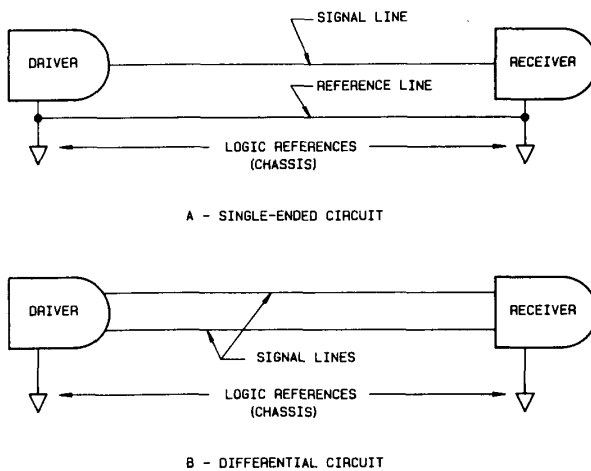

Fig. 15. Links between driver and receiver of computer and remote terminal.

the chassis. Fig. 15 is a schematic of the receiver and driver circuits used to communicate between the computer and its terminals. This figure shows that the designer has the option of using single-ended transmission, where the signals are developed with respect to a zero-reference plane, or a differential transmission, where signals are developed as a voltage difference between the two signal lines.

Typically, a twisted-pair cable or a coaxial cable is used between the computer and the terminal. Various types of shielding may be included with these cables. Intuitively, one might expect that the receivers and drivers linked by a shielded cable should be least susceptible to interference or damage. However, the problem encountered here does not involve transients coupled capacitively or inductively onto the data communication cables. Rather, the problem is a difference in the reference potentials of the chassis of the two devices, resulting from surges being diverted in the separate grounding connections of the two devices.

Fig. 16 shows a schematic of a system consisting of a computer and a terminal, powered by different sources and linked by a shielded two-wire differential data line with zero reference bonded to the chassis of each device. In each power supply, an electromagnetic interference (EMI) filter or surge

suppressor has been provided between the ac lines and the grounded chassis.

Let us now examine the scenario unfolding when surges arrive on the *power supply line* of the computer. The expected role of the EMI filter is to divert these surges to ground—that is, by passing the current  $i$  through the filter, returning it to the power source by the grounding conductor  $G$ . This path unavoidably has a finite inductance  $L$ . Consequently, the fast-changing current  $i$  produces a voltage drop  $L \cdot di/dt$  between the computer chassis (which is the signal reference at the sending end) and the grounding connection of the power supply. At the terminal, no surge event is occurring at that time; the terminal chassis (which is the signal reference at the receiving end) stays at the potential of the grounding connection  $G'$  of its own power supply. The two chassis, therefore, the two references of the *data link ports* are now at different potentials. This difference is the  $L \cdot di/dt$  voltage from the surge, *plus* any other voltage that might develop in the undefined path linking the two grounding points  $G$  and  $G'$ . This scenario explains how surges, initially limited to the power lines, can impact the data port components of a system powered without the installation of coordinated surge suppressors on both power port and data port.

Thus, with hindsight, this anecdote illustrates the need for developing and applying means of surge protection that will avoid the potential difference between ends of the data link. This need presents a challenge to the designers of an information technology system and an opportunity for the manufacturers of packaged surge-protective devices: coordinating protection of the power supply port with protection of the data link port in a single unit, with the same return path for surges diverted by the two protective devices. Such coordinated surge suppressors built for protecting both ports and using a single ground reference are now commercially available. They are sometimes referred to as "local ground window" [12].

#### CONCLUSION

1) The response of the step down transformer and its associated bus wiring to stimulation by a  $1.2/50\text{-}\mu\text{s}$  unidirectional surge contains two components:

- a unidirectional component matching the stimulation, and
- a ringing overshoot at a frequency dependent upon the circuit characteristics.

2) The unidirectional surge couples through the transformer according to the turns ratio, with negligible attenuation. The ringing overshoot frequency depends on the circuit parameters; its peak can exceed twice the peak of the stimulus.

3) The existence of multiple branch circuits in the building wiring reduces the overshoot and affects its frequency but does not change the unidirectional component.

4) A ring wave with a rise time shorter than the travel time in a simple point-to-point line produces the expected enhancement of the surge at an open-circuit receiving end. Adding loads at the end of the line reduces the amplitude of the surge at that point in a predictable manner, according to the classical transmission line theory.

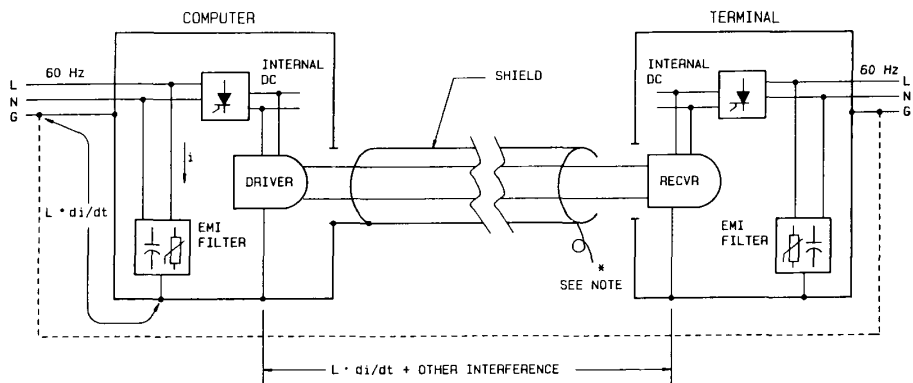

\* SOME ORGANIZATIONS INSIST ON HAVING ONE END OF THE SHIELD FLOATING

Fig. 16. Scenario for creating difference of potential between signal references by diverting surge through grounding conductor of one side of the system.

5) Adding branch circuits and other circuit elements along the propagation path introduces mismatches in the line impedance, reducing the amplitude of the initial peak of the surge arriving at the receiving end. Subsequent parts of the surges, however, are less affected.

6) Providing protection against power line surges at the power line interface of devices linked by a data communication circuit does not guarantee that surges occurring in the power line environment will not cause damage to the devices. A more comprehensive protection scheme, coordinating both the power line and the data line, is required to ensure protection.

#### APPENDIX

##### INSTRUMENTATION AND EXPERIMENTAL PROCEDURES

For complete documentation of the test procedure, the instrumentation used in the tests is listed in this Appendix<sup>1</sup>. Also, some practical aspects of the procedure and logistics are recited here; some were planned, some resulted from hindsight. These are offered as helpful hints to anyone planning this type of field test.

##### Instrumentation

**Surge Generator:** A KeyTek Model 711 was used, with F31 coupling network and plug-in pulse waveshaping networks: P7 for 1.2/50  $\mu$ s unidirectional waveform, and P1 for 100-kHz ring wave as described in [6].

**Storage Oscilloscopes:** Two Tektronix 7934 with 500-MHz bandwidth were used, each with pairs of matched 1000:1 P6015 probes or 100:1 P6009 probes. The probes were connected differentially with a 7A26 vertical preamplifier performing the differentiation.

**Auto-ranging Monitors:** A BMI 4800 Powerscope with three-phase multimode monitoring capability, graphic display, auto-ranging of sweep rate, and adjustable threshold was employed.

<sup>1</sup> Certain commercial instruments are identified in this paper to specify the experimental procedure adequately. Such identification does not imply a recommendation or endorsement by the National Institute of Standards and Technology, nor does it imply that these instruments are necessarily the best available for the purpose.

##### Procedure

**Surge Coupling:** The surges produced by the generator were injected into the building wiring by a 2- $\mu$ F coupling capacitor for the initial unpowered tests. For subsequent tests with power on, a coupling circuit was used so that the surge was applied at a fixed phase of the sine wave.

**Differential Measurements:** All measurements were made with a differential connection of two matched probes. Admittedly, the 7A13 differential preamplifier would be more appropriate for this type of connection, but it was not available for these field tests. The common-mode rejection and noise background were checked by connecting the two probes together and then to the high and low side of the point of measurement.

One of the planned measurements was to measure the voltage between the building grounding system and one of the so-called "isolated separate dedicated ground" ground rods, deliberately installed in the building as a tutorial example of questionable practice. For this measurement, however, the differential connection with the 7A26 preamplifier and unshielded oscilloscope was not successful. The levels of voltages observed across the desired points of measurement had the same order of magnitude as the noise background observed in the check just described. Instrumentation less sensitive to this interference was not available for these field tests, but new attempts might be made in the future.

##### HELPFUL HINTS

While these hints might seem trivial, they are offered after successful planning or hindsight and as a counterpoint to the more fundamental conclusions of the paper. If they can save time or reduce problems for future experimenters, including them in this paper will have been worthwhile. In random order of importance, here is a list.

- Whenever field measurements involve several people at different locations, walkie-talkies are far superior to direct voice communication (attenuated by distance), fast-footed couriers, or an internal telephone network.
- Whenever the work is carried on outside of normal working hours, be sure that the team includes one

- individual thoroughly familiar with the facility, and custodian of *all* keys to rooms, cabinets, and *interlocks*.
- The availability of monitoring instruments that combine logging and timing of events provides a very useful correlation of recordings made by independent oscilloscopes.
  - Always bring at least twice as much film as you think you will need. The same remark applies to materials for filing oscillograms at the site, and to extension cords.
  - Bring some spare fuse holders for the instruments. These protruding accessories have a unique capability of coming loose during shipment and getting lost in the packing material.
  - When scheduling the rate of progress in the tests, remember that Murphy was an optimist!

#### ACKNOWLEDGMENT

The measurements and the analysis of the results were made possible by the cooperation and contributions of many organizations and individuals, as follows:

- Building Industry Consulting Service International, for coordinating an informal consortium of private sector companies in support of this work;
- Alex McEachern, for making the facilities of Basic Measuring Instruments available as a measurement site;
- Joseph Connolly, Robb Gould, Jim McDaniels, and Christine Mihelich, for their participation in the measurements;
- Maurice Tetreault, for participating in the measurements and suggesting the principles underlying the analysis of the surge side effects on the data ports;
- Catherine Fisher, for suggestions on reporting these results.

These contributions to improved understanding of the problems, and thus greater system reliability, are most gratefully acknowledged.

#### REFERENCES

- [1] F. D. Martzloff, "The propagation and attenuation of surge voltages and surge currents in low-voltage ac power circuits," *IEEE Trans. Power App. Syst.*, vol. PAS-102, no. 5, May 1983.

- [2] F. D. Martzloff and H. A. Gauper, "Surge and high-frequency propagation in industrial power lines," *IEEE Trans. Ind. Appl.*, vol. IA-22, no. 4, July/Aug. 1986.
- [3] L. V. Bewley, *Traveling Waves on Transmission Lines*. New York: Dover, 1963.
- [4] F. D. Martzloff and P. F. Wilson, "Fast transient tests: Trivial or terminal pursuit?" in *Proc. Int. Zürich Symp. Electromagnetic Compatibility*, 1987.
- [5] F. D. Martzloff and T. F. Leedy, "Electrical fast transient tests: applications and limitations," *IEEE Trans. Ind. Appl.*, vol. 26, no. 1, pp. 151-159, Jan./Feb. 1990.
- [6] *IEEE Guide on Surge Voltages in Low-Voltage AC Power Circuits*, ANSI/IEEE Standard C62.41-1980.
- [7] R. B. Standler, "Equations for some transient overvoltage test waveforms," *IEEE Trans. Electromagn. Compat.*, vol. EMC-30, no. 1, Feb. 1988.
- [8] *Insulation Coordination within Low-Voltage Systems, Including Clearances and Creepage Distances for Equipment*, IEC Pub. 664-1980.
- [9] *IEEE Guide on Surge Testing for Equipment Connected to Low-Voltage AC Power Circuits*, ANSI/IEEE Standard C62.45-1987.
- [10] A. K. Agrawal, H. M. Fowles, and L. D. Scott, "Experimental characterization of multiconductor transmission lines in inhomogenous media using time-domain techniques," *IEEE Trans. Electromagn. Compat.*, vol. EMC-21, no. 1, Feb. 1979.
- [11] A. H. Paxton and R. L. Gardner, "Application of transmission line theory to networks with a large number of component wires," in *Proc. Int. Zürich Symp. Electromagnetic Compatibility*, 1987.
- [12] F. D. Martzloff, "Protecting computer systems against power transients," *IEEE Spectrum*, April 1990.

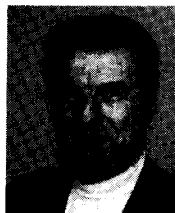

**François D. Martzloff** (M'56-SM'80-F'83) completed his undergraduate studies in France and received the M.S.E.E. degree from the Georgia Institute of Technology, Atlanta, and the M.S.I.A. degree from Union College, Schenectady, NY.

After a long career at General Electric, he joined the staff of the National Bureau of Standards (now renamed National Institute of Standards and Technology) to work on conducted electromagnetic interference issues. His early experience covered high-voltage fuses, high-voltage bushings, and electronic power conversion; the latter marked a turning point to issues of overvoltage effects on semiconductors, surge suppression, metal oxide varistor applications, and interference mitigation. In addition to his research work on surge propagation and mitigation, he is contributing to the development of standards on surge environment and surge suppression within IEEE, ANSI, and IEC by documenting his measurements, as in the present paper, by presenting tutorials, and by drafting new standards.