

Instruction Manual

pH/Ion 510

Bench pH/Ion/mV Meter

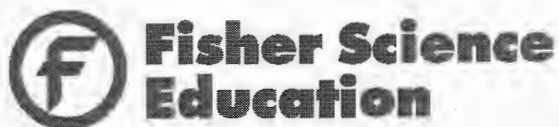

68X090829
Rev. 0 Nov 05

PREFACE

Thank you for choosing the pH 510 pH/mV/Temperature or Ion 510 Ion/pH/mV/Temperature bench meter.

The instruction manual functions in two ways: firstly as a step-by-step guide to help you operate the 510 series meter. Secondly, it serves as a handy reference guide.

The instruction manual is written to cover as many anticipated applications of the pH/Ion 510 Bench meter series as possible. If there are doubts in the use of the instrument, do not hesitate to contact the nearest Authorized Distributor.

Fisher Science Education cannot accept any responsibility for damage or malfunction to the meter caused by improper use of the instrument.

The information presented in this manual is subject to change without notice as improvements are made, and does not represent a commitment on the part of Fisher Science Education.

Note: Fisher Science Education reserves the right to make improvements in design, construction, and appearance of our products without notice.

Copyright © 2005 All rights reserved.
Fisher Science Education

TABLE OF CONTENTS

1	INTRODUCTION	1
1.1	Introducing the 510 Bench Series.....	1
1.2	Custom LCD.....	1
1.3	Keypad.....	2
1.4	Rear Instrument Panel.....	3
2	STARTING UP	4
2.1	Connecting the Sensor Electrode.....	4
2.2	Connecting the Temperature Probe.....	4
2.3	Connecting the A/C Adapter.....	4
2.4	Connecting the Chart Recorder.....	4
2.5	Connecting the Electrode Holder (Optional).....	5
2.6	Steps Prior to Calibration.....	6
3	CALIBRATION	6
3.1	pH Calibration.....	6
3.2	Ion Concentration Calibration (For Ion 510 only).....	9
3.3	mV Calibration.....	11
3.4	Temperature Calibration.....	12
4	MEASUREMENT	13
4.1	Automatic Temperature Compensation (ATC).....	13
4.2	Manual Temperature Compensation (MTC).....	13
4.3	Taking Measurements.....	14
4.4	HOLD Function.....	15
4.5	Storing and Recalling Data from Memory.....	15
5	SETUP FUNCTIONS	17
5.1	P1.0 Clear Memory.....	17
5.2	P2.0 Viewing Electrode Diagnosis.....	18
5.3	P3.0 Selecting pH Buffer Standard.....	19
5.4	P4.0 Meter Reset.....	19
6	pH Electrode Maintenance	20
6.1	Storage.....	20
6.2	After Use.....	20
6.3	Electrode Cleaning.....	21
6.4	pH Electrode Rejuvenation.....	22
7	TROUBLESHOOTING GUIDE	23
7.1	Error Messages.....	23
7.2	Troubleshooting.....	24
8	ADDITIONAL INFORMATION	25
8.1	pH and Temperature.....	25
8.2	Use of Standard pH Buffers.....	25
8.3	Standard pH Buffers.....	25
8.4	Specifications.....	26
9	WARRANTY	27
10	RETURN OF ITEMS	27

1 INTRODUCTION

1.1 Introducing the 510 Bench Series

The pH 510 and Ion 510 bench meters are microprocessor-based which incorporates new ASIC (Application Specific Integrated Circuit). It is designed with convenience in mind, and offers many advanced user-friendly features. The meters are capable of storing and recalling up to 50 data sets in its non-volatile memory. In addition, as a space saver, an optional swivel electrode holder can be attached at the either side of bench meter for resting the electrodes and probes during operation.

The pH 510 meter is capable of measuring pH/ORP with Temperature; while the Ion 510 meter measures Ion Concentration/pH/ORP with temperature. It is equipped with a large customized LCD (Liquid Crystal Display) with simultaneous display of the measured values for easy reading. It is most ideal for routine pH/Ion Concentration measurement in indoor applications.

1.2 Custom LCD

The 510 meter is characterized by a large custom dual LCD. The display has mode annunciators for pH, mV, ppm and temperature readings. The secondary (lower) display shows the temperature reading simultaneously with the primary (upper) display that shows the measured values of pH, ppm or mV. Special annunciators such as units of measure, error message, graphical icons and modes of operation are arranged around both primary and secondary display to give you a comprehensive yet uncluttered display.

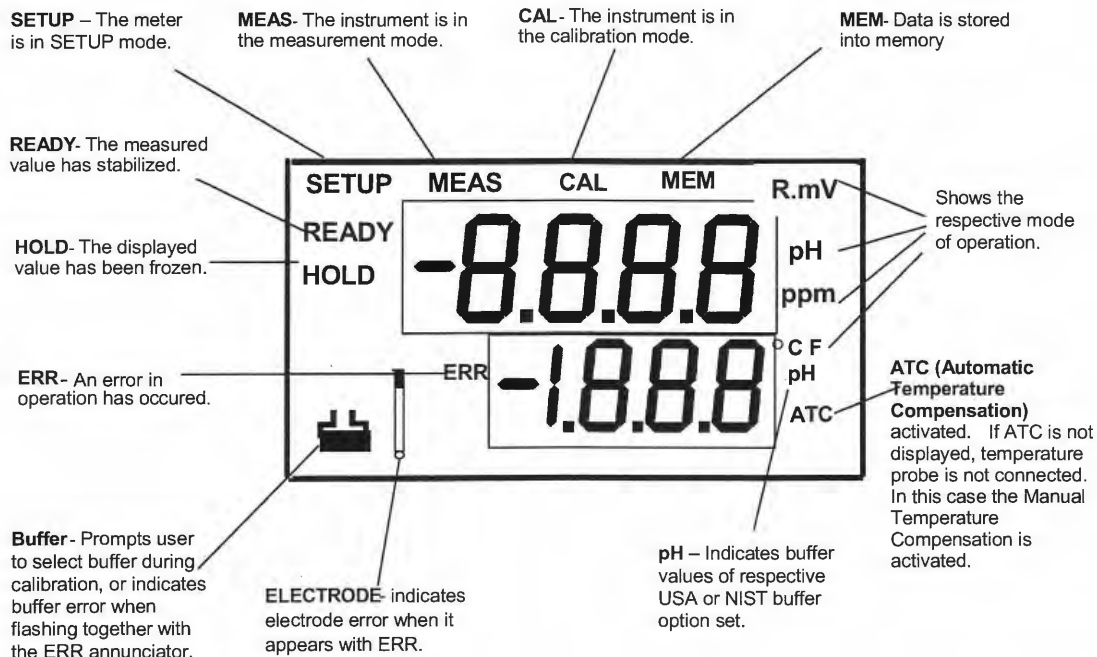

1.3 Keypad

A large splash proof membrane keypad with tactile feedback makes meter easy to use. Names and symbols describe the function button controls.

Key	Measurement Mode	Calibration / Setup Mode
ON/OFF	Powers the meter ON/OFF. When the meter is switched on, it automatically starts in the last mode of operation.	~
CAL/MEAS	Toggles between the measurement and calibration modes of the meter. In SETUP mode, pressing CAL/MEAS key returns to the measurement mode.	~
MODE	Toggles between the different measurement modes available pH/Temperature/mV/Ion. (Ion mode only applies with the ION 510.)	Switches from pH to Temperature in pH calibration mode
MI/▲	MI inputs measurements into memory and scrolls through memory values.	▲ scrolls values in mV calibration mode and selects temperature values and ion options in calibration mode. Scrolls to next program in the SETUP mode.
MR/▼	MR recalls measurements from memory and scrolls through memory values.	▼ scrolls values in mV calibration mode and selects temperature values and ion options in calibration. Scrolls to next program in the SETUP mode.
HOLD	Freezes a measurement on the display. Press again to get current readings.	~
ENTER	Enter functions in the memory mode.	Confirms and enters the value selected for calibration.

You can also configure functions like Meter Reset, Memory Clear and Selection of pH Buffer Standard via the keypad. Please refer to Section 5 for more information on the above functions.

1.4 Rear Instrument Panel

This 510 series meter provides a complete set of connectors for the various accessories commonly used. Listed in the table are the details of the connections that you can make.

Rear View of Meter

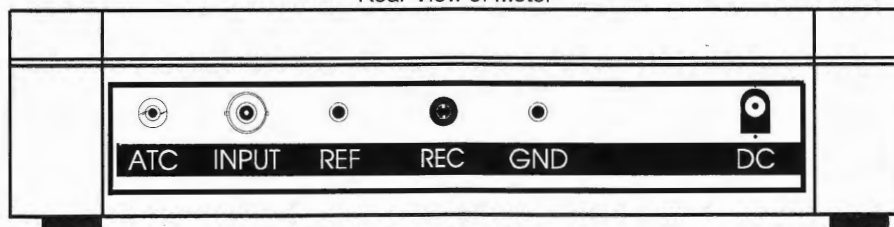

Connection	Function
ATC	For phono jack connection from the temperature probe for Automatic Temperature compensation. The probe should be a 30K Ω thermistor type.
INPUT	For connection to sensor electrodes with BNC type connectors. The meter accepts any pH, ORP or ISE with BNC connector. Always ensure that the connector is clean and dry.
REF	For connection to pin type reference electrode normally used with half cell (mono) type pH electrodes or ISEs.
REC	For connection to strip chart recorders. Use subminiature plug with positive tip.
GND	For connection to the ground earth jack (standard tip connectors).
DC	For connection for the AC/DC power adapter

2 STARTING UP

Connect the accessory connectors at the rear of the instrument panel. During operation, it is important that water does not get onto the BNC connector. Also avoid touching the connector with soiled or wet hands.

2.1 Connecting the Sensor Electrode

Slide the electrode connector of the electrode over the socket of the meter's BNC connector marked 'INPUT'. The meter can accept any standard pH, ORP, or Ion Selective Electrode with a BNC connector. Align the slot of the electrode connector with the posts of the socket. Rotate the connector clockwise until it locks. For separate reference electrodes, push the electrode pin into jack marked 'REF'.

2.2 Connecting the Temperature Probe

Insert the temperature probe (provided) into the connector marked 'ATC'.

2.3 Connecting the A/C Adapter

Slide in the adapter jack of the A/C adapter into the back panel marked 'DC' until it is firmly seated. Ensure that the power is switched off before installation and the correct voltage adapter is used.

2.4 Connecting the Chart Recorder

You can connect chart recorders or external output devices for continuous printout. Plug in the input connector and ground pin of the chart recorder into the ports marked 'REC' and 'GND' respectively.

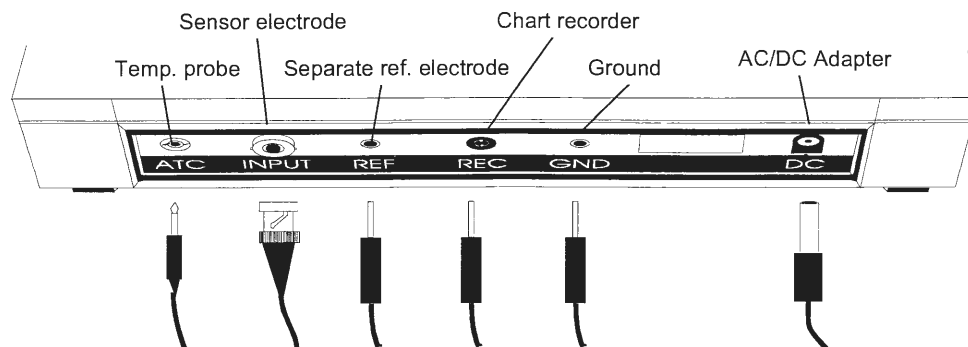

2.5 Connecting the Electrode Holder (Optional)

The integral electrode holder serves as a handy holder for mounting a few pH/ion electrodes or a temperature probe during measurement or when idle.

This meter's base plate has a side metal bar to which you can attach an integral swivel electrode holder. You can mount the electrode holder on either right or left side of the meter.

To position the electrode arm:

Use a Phillips screwdriver to remove the screw holding the electrode holder. Slide the side metal bar until the second screw slot lines up with the original screw hole. Use the screw removed earlier to secure the electrode holder into position.

NOTE: The side metal bar is reversible. If desired, remove screw holding electrode holder base and slide out of brackets, Slide base into brackets on opposite side and tighten screw.

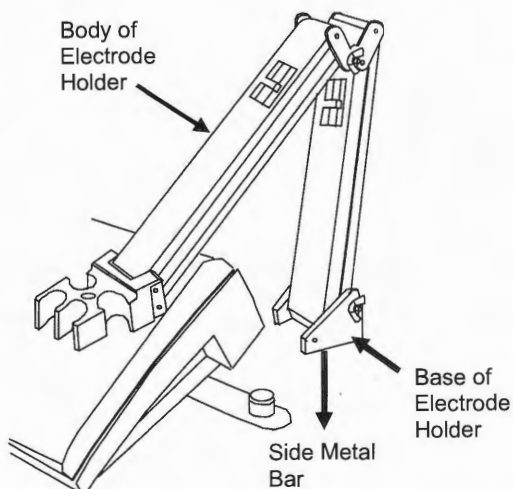

Bottom of Meter

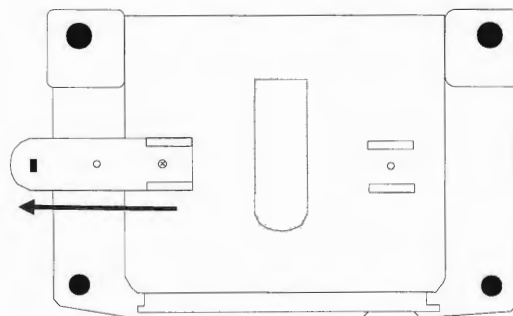

To install the electrode arm to the meter:

To mount the electrode arm into the metal rod on the side bar, align the slot with the metal rod and base of electrode arm. Push it downwards until it fully sits into position. Avoid using excessive force when fixing or removing. The electrode arm is ready for use.

NOTE: Move the base of the electrode holder if you wish to swing the electrode holder about. To prevent the meter from toppling over causing accidental spills, **DO NOT** swing the body of the electrode holder.

2.6 Steps Prior to Calibration

2.6.1 Switching 'ON' and 'OFF' the meter

Press **ON** key to switch meter on. All the LCD segments will display momentarily for a few seconds and the LCD then switches to the last measurement mode. To switch meter off, press **OFF** key.

2.6.2 Selecting Measurement Mode

The measurement modes available for the pH 510 meter are pH, mV (for ORP) and Temperature, while the Ion 510 meter has Ion, pH, mV and Temperature measurement modes. Select the correct mode of operation by pressing the **MODE** key, and each press takes you to next measurement mode. When selecting a particular parameter the respective mode annunciator displays at the right hand side of primary display; these include [pH] for pH, [°C] for Temperature, [ppm] for Ion Concentration and [mV] for Millivolt.

2.6.3 Meter Reset

On first use, it is not necessary to reset meter before calibration as it has been factory-calibrated. However if you wish to reset the meter to factory default refer to Section 5.4.

NOTE: Re-calibration of meter is required before measurement after the meter is reset. Likewise if you wish to prepare a new set of measurements, you may reset all the last calibrated pH values simultaneously for added convenience. **Caution: All calibration values and memory data will be erased upon activation. Re-calibration is required.**

2.6.4 Selecting pH Buffer Standard

The meter is capable of calibrating based on either USA or NIST pH buffer standards. Please refer to Section 5.3 P3.0 for details on how to change the USA buffer standard to the NIST standard on the meter itself. Refer to Section 8.4.1 for more details on pH buffer standards available.

NOTE: Remove protective rubber cap or storage bottle (if any) from the electrode before proceeding with measurement or calibration. Take care not to exert too much force as this may cause damage to the electrode. Whenever the electrode is not in use, put it into storage bottle or protect the electrode with the rubber cap provided. Refer to the Section 6 on Probe Maintenance for more details.

3 CALIBRATION

3.1 pH Calibration

The 510 series bench meter is capable of multi-point calibration (up to 3 points) for high accuracy across the measurement range. The 3-point calibration offers flexibility of calibrating using either USA or NIST buffer standards with their 3 internationally accepted calibration points namely:

USA standard buffer options: pH 4.01, pH 7.00 and pH 10.01

NIST standard buffer options: pH 4.01, pH 6.86 and pH 9.18.

For ATC measurements, attach the temperature probe to the meter. The ATC mode annunciator shows on the display. Insert the probe into the solution to be measured so that the sample temperature can be recorded and pH readings automatically temperature compensated. If manual temperature compensation is preferred, do not plug a temperature probe into the meter.

DO NOT REUSE SOLUTIONS AFTER CALIBRATION. Contaminants in the solution can affect the calibration, and eventually the accuracy of the measurements.

One point calibration (Offset calibration) should only be carried out with pH 7.00 or pH 6.86; otherwise calibration will not be accepted. For Slope to Slope calibration (two points calibration), the first calibration point will only be successfully registered in the meter after the second point calibration has been completed.

It is recommended that you perform at least a 2-point calibration using buffers that bracket (one above and one below) the expected sample range, starting with pH 7 buffer first. Select a pH 4, 7 or 10 buffer in sachets or bottles from standard buffer solutions.

All new calibrations will replace the existing stored calibration data.

1. Press **ON/OFF** key. All the LCD segments will be displayed momentarily. The LCD switches to pH measurement mode. If necessary press **MODE** key to select pH mode.

NOTE: The meter starts in the same measurement mode that it was switched off.

2. The customized LCD display will indicate the following:

Display	Remarks
MEAS	Measurement mode is selected
pH	Unit of measurement
°C	Measured temperature reading
ATC	Automatic Temperature Compensation (If temperature probe or "All-in-One" probe is connected)"

3. Rinse the pH electrode well with deionized water or rinse solution. If using the ATC function with a separate temperature probe, thoroughly rinse the temperature probe as well. **(Do not wipe the electrode or the temperature probe as this may cause a build-up of electrostatic charge and will create calibration and measurement instability!).**

One Point Calibration

4. Select the first pH buffer, pH 7.00 (or pH 6.86) and pour some into a clean container.
5. Dip both probes into the standard calibration buffer. The end of the probe must be completely immersed into the buffer. Stir the probes gently to create a homogenous solution.
6. Press **CAL/MEAS** key to enter the pH calibration mode. The annunciator [**CAL**] appears on top of the LCD to indicate the meter is in pH calibration mode. The upper display will show the measured reading while the lower display indicates appropriate pH standard buffer solution being used.

NOTE: The meter automatically recognizes the buffers in the buffer standard you have set in the SETUP mode, i.e. either USA (pH 4.01, 7.00 or 10.01) or NIST (pH 4.01, 6.86 or 9.18) buffers.

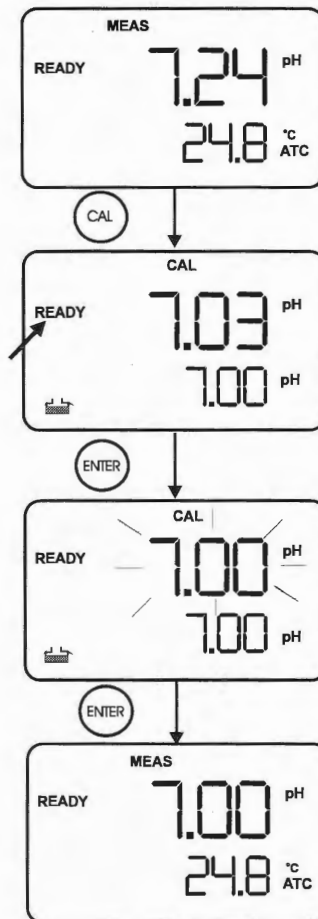

Figure 1: 1st-point calibration

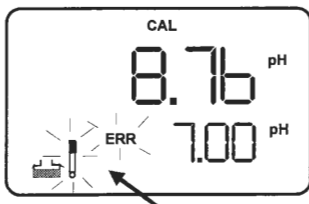

Figure 2: Calibration error

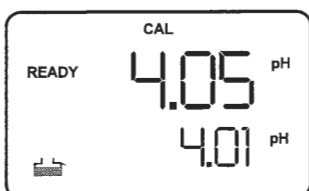

Figure 3: 2nd-point calibration

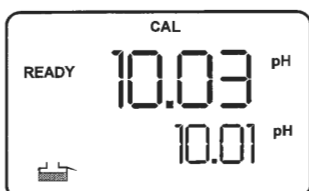

Figure 4: 3rd-point calibration

HINT: If the selected buffer value is not within the accepted window (see below) from the measured value: the electrode and buffer icon blink and ERR annunciator appears next to the secondary display. (See Figure 2 above) Press CAL/MEAS key to exit the ERR condition.

Window of Accepted Values:-

USA	4.01	±1.00
	7.00	±1.50
	10.01	±1.00
NIST	4.01	±1.00
	6.86	±1.25
	9.18	±1.00

7. Wait for the measured pH value to stabilize (when the [READY] indicator displays in the left-hand corner).

NOTE

If the upper measured display is not within the buffer acceptable window (refer to Hint below) an error message and the electrode icon flash upon pressing the **ENTER** key. Refer to Section 7, Troubleshooting Guide. Check electrode condition and recalibrate. Press **CAL/MEAS** key to exit calibration and resume to the measurement mode.

8. Press the **ENTER** key to confirm the calibration. The upper display flashes the calibration value momentarily before storing the calibration point in the meter. The lower display then toggles between the next calibration buffer values.
9. If you are performing a one-point calibration, press **CAL/MEAS** key to return to the measurement mode and start taking pH readings (see Figure 1).

NOTE

To exit from pH calibration mode without confirming calibration, **DO NOT** press **ENTER** key in step 9. Press the **CAL/MEAS** key instead.

Two to Third Point Calibration

10. If you are performing a multi-point calibration (i.e. second-point or more) go to step 11.
11. Rinse the probes with deionized water or rinse solution to avoid cross contamination, and place them in the next pH buffer, say pH 4.01 buffer. The lower display of the meter automatically switches to the pH buffer solution selected.
12. Wait for the measured pH value to stabilize (when the [READY] indicator displays in the left-hand corner). (see Figure 3).
13. Press the **ENTER** key to confirm the calibration. The upper display flashes the calibration value momentarily before storing the calibration point in the meter. The lower display then switch to the next calibration buffer value.
14. If you are performing a two-point calibration, then press the **CAL/MEAS** key to return to the measurement mode and start taking pH readings.
15. If you are performing a three-point calibration go to step 16.
16. Rinse the probes with deionized water or rinse solution, and place them in the next pH buffer as indicated in the lower display, say pH 10.01 buffer.
17. Wait for the measured pH value to stabilize (when the [READY] indicator displays in the left-hand corner) (see Figure 4).
18. Press the **ENTER** key to confirm the calibration. The upper display flashes the calibration value and then stores the calibration point in the meter. The meter automatically returns to the pH measurement mode after a three-point calibration is performed.

3.2 Ion Concentration Calibration (For Ion 510 only)

The Ion 510 meter is capable of up to 3-point ion calibration (minimum 2 point) with choice of 4 options to ensure accuracy across the entire measurement range. Note that the ion measurement mode accepts input of only ± 500 mV. Ion calibration options include 0.10, 1.0, 10.0 or 100.0 ppm. All calibration should be at least one decade apart from each other. For example you may perform 3 point calibration to 0.10, 1.0 and 10.0, or 2-point calibration to 10.0 and 100.0. If 1-point calibration is performed an error message "Er2" is displayed. If any of calibration points are not within 1 decade, an error message "Er4" will be displayed at the end of calibration process.

Calibration values are successfully stored if the ISE slope is within the specified tolerance of 15mV/decade (minimum) and 90mV/decade (maximum), otherwise an error message "Er3" is displayed (see Figure 7). The calibration values are not stored into the meter's built-in memory if any error message appears after each calibration process. Re-calibration is necessary as calibration is unsuccessfully attempted in this instance. Check that your ISE and standard solutions are in good working conditions.

Ensure that you use new or fresh standard solutions during calibration. Do not reuse ion standard solution as it may be contaminated and affect the calibration and accuracy of measurements. Always store standard solutions in a dry, cool environment if possible. Before use, remove plastic protective cap of ISE. Briefly rinse the electrode with clean deionized water to remove any residues.

Rinse probes before and after each calibration or sample measurement to avoid cross-contamination. For more details please refer to Manufacturer's care and maintenance guide.

NOTE: The ion calibration values will be lost once power is disconnected; only pH and mV calibration values will be retained.

1. Connect an Ion Selective Electrode (ISE) to the BNC input connector on the back of the meter. Turn the meter **ON**.
2. Press **MODE** key (if needed) to select ion measurement mode. If there is no old calibration values, then the meter displays "—" in the upper display in measurement mode.
3. Dip the ISE into the first calibration standard. Make sure to start with the calibration standard that has the lowest concentration and move up to the standards that have higher concentrations.

Swirl it gently. Press **CAL** key to enter the ion calibration mode. The [CAL] indicator appears above the upper display and the upper display reads "0.10". The lower display shows the corresponding absolute mV value of sample measured.

4. The first calibration point of **0.10 ppm** appears on the display. If you **DO NOT** wish to calibrate to this point, press (up arrow) to skip and continue to the next calibration point of 1.0 ppm or 10.0 ppm.
5. If you **DO** wish to calibrate to 0.10 ppm, allow the mV reading to stabilize. When the reading stabilizes the [READY] indicator will appear on the display. Stabilization may take a few minutes depending on electrode and standard concentration.
6. Press **ENTER** key to confirm your first point calibration (see Figure 5). After calibration, the display will show the next calibration option, i.e. **1.0 ppm**. Proceed by rinsing the electrode with deionized water before placing it in the next calibration standard i.e. 1.0 ppm.
7. Allow the meter to stabilize in the next calibration standard. Wait for the [READY] indicator to appear before you press the **ENTER** key to confirm the second calibration point. The upper display flashes momentarily then moves to the next calibration point of 10.0 ppm.

NOTE: If you are performing a 2-point ion calibration, press **CAL/MEAS** key. "SLO" appears in the upper display with the [mV] indicator and the number in the lower display is the electrode slope in mV (see Figure 6). You are ready to take ion measurements. If the slope is outside the acceptable limits or if incorrect standards have been used the upper display will show "Er3" (see Figure 7).

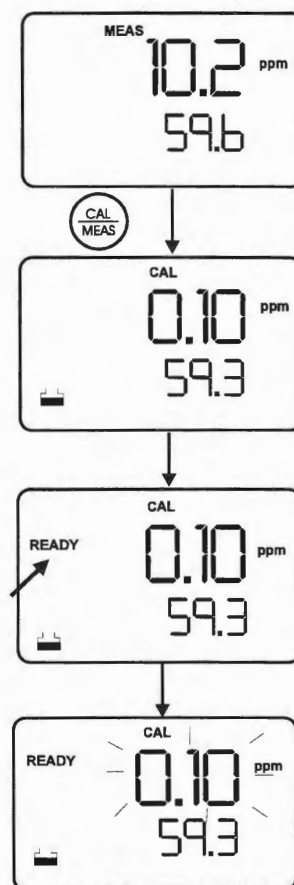

Figure 5: 1st-point calibration

If you are performing a 3-point calibration, rinse off the electrode with deionized water, place it in the next calibration standard and proceed as follows.

8. Allow meter to stabilize in the next calibration standard. Wait for the [READY] indicator to appear before you press the **ENTER** key to confirm the third calibration point. The upper display flashes for a few seconds then "SLO" appears in the upper display with the mV indicator, the number in the lower display is the average electrode slope in mV (see Figure 6). After a few seconds the meter reverts to the measurement mode. You are now ready to take ion measurement.

NOTE: All the calibration values are successfully stored. Otherwise error message will appear in the LCD if the calibration was unsuccessful with no values stored into memory.

NOTE: You may compare the average electrode slope value with the expected slope value for your electrode from your electrode manual to verify electrode operation.

HINT: Minimum of 2 points and maximum of 3 points are allowed for Ion Calibration. All calibration points should be at least one decade apart, i.e. valid calibration points are 0.1, 1, 10 ppm or 1, 10, 100 ppm or 0.1, 1 ppm or 1, 10 ppm or 10, 100 ppm.

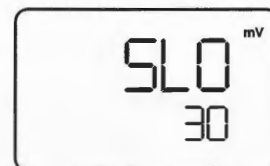

Figure 6: Slope value in mV

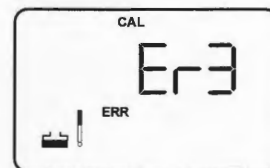

Figure 7: Error message Er3 if slope not within range

3.3 mV Calibration

1. Make sure the meter is on and if necessary, press the **MODE** key to select mV mode. The [mV] indicator appears in the upper right-hand corner of the display.
2. Press the **CAL/MEAS** key. The [CAL] indicator appears above the upper display that displays the relative mV reading. The lower display shows the absolute mV value.

NOTE: If you have never calibrated relative mV or if the meter has been reset, the value shown in the upper display is the same as the absolute mV value. The range of adjustment is -1999 mV to 1999 mV (resolution is 1 mV); of which from -199.9 to 199.9 mV the meter gives you a resolution of 0.1 mV.

3. Press \blacktriangle or \blacktriangledown key to enter the relative mV value that matches your desired reading.
4. Press the **ENTER** key to confirm the reading and the meter automatically returns to the measurement mode. The upper display now shows the relative mV reading. The [R.mV] indicator appears in the upper right hand corner.

NOTE: New mV calibrations will override existing stored mV calibration data. The meter retains stored mV calibrations even when the meter is turned off.



4.3 Taking Measurements

Be sure to remove any electrode soaker bottle or protective rubber cap from the electrode before measurement.

To take readings:

1. Rinse the electrode with distilled or tap water before use to remove any impurities adhering to the electrode body. If the pH electrode had dehydrated, soak it for 30 minutes in EC-RE005/ 00653-04 electrode storage solution. (See Electrode Care - Section 6)
2. Press **ON** key to switch on meter. The [MEAS] annunciator appears on the top center of LCD. The ATC annunciator appears in the lower right hand corner to indicate ATC if a temperature probe is plugged. (For MTC, refer to Section 4.2).
3. Dip the electrode and temperature probe into the sample, making sure that the glass bulb of the electrode must be completely immersed into the sample. Stir the probes gently to create a homogeneous sample.
4. Allow time for reading to stabilize. When the readings stabilize, a [READY] annunciator displays. The READY mode shows the readings are stable within a range of ± 0.01 pH. When this occurs, the [READY] annunciator appears on the top left side of LCD. Take the reading.
5. To toggle between pH and mV in the pH510, or to toggle between pH, mV and Ion in the Ion 510, press the **MODE** key.

4.4 HOLD Function

This feature lets you freeze the value of the measured reading. HOLD can be used anytime when in [MEAS] mode. You can store the held reading into memory by pressing **MI** key.

HOLDing a measurement

To hold a measurement, press the **HOLD** key while in measurement mode. [HOLD] annunciator will appear on the display.

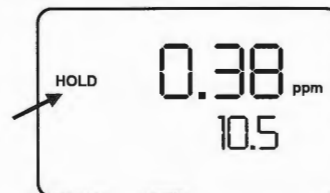

Releasing a Held Value

To release the held value, press **HOLD** key again. [HOLD] annunciator will disappear from the LCD. Continue to take measurements.

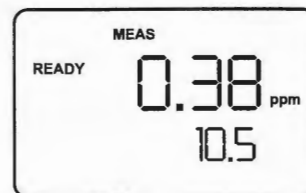

4.5 Storing and Recalling Data from Memory

The meters allow up to 50 data sets to be stored and recalled into its non-volatile memory in the Last-In-First-Out (LIFO) sequence. The data set is also stored with specified location as indicated on the display. However you can selectively view the data at that specified location for added convenience.

pH 510 meter:

- pH and Temperature
- mV (or Relative mV) and temperature

Ion 510 meter:

- pH and Temperature
- mV (or Relative mV) and temperature
- ion and mV

For example you can store 32 pH and 18 mV values for the pH 510 or 15 ion, 12 mV and 23 pH values for the Ion 510.

Memory Input

This feature allows you to store measurement readings into memory for later review. This mode can be invoked at any time during measurement mode or when the reading is frozen ([HOLD] annunciator is displayed on LCD by the activation of HOLD key).

To store reading:

1. During any measurement or HOLD function, press the **MI** key once to input data into the memory.
2. [MEM] annunciator, "StO" and memory number will flash momentarily. The meter then returns to the measurement mode.
3. To continue storing data, press **MI** key again.

NOTE: If the memory is full, the first value stored will be erased to create space for the new value.

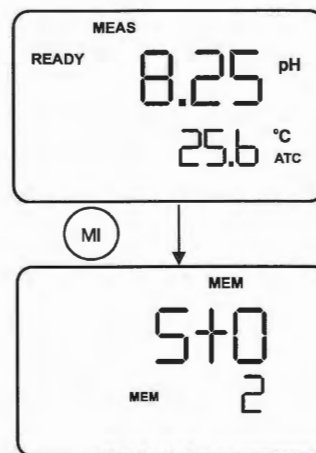

Memory Recall

1. In the measurement mode, press **MR** key once to retrieve the last reading stored. The memory location screen – “MEM”, “LOC” and the memory number – will flash on the display.
2. Press the **ENTER** key to recall the reading stored under that memory number.
3. If necessary, you can selectively choose to view any data that is stored by using **▲** or **▼** key. For example to view the third data location set to LOC 3 from last stored location of LOC 5. Use **▲** or **▼** key to set to LOC 3. Press **ENTER** key to retrieve the data from this location.
4. To continue reviewing additional stored data, press **ENTER** key again. For this instance the next location, LOC 2, will be displayed.
5. To exit Memory Recall and operate meter, press the **MEAS** key to return to the measurement mode.

NOTE: Readings stored in memory are retained even of the unit is turned off. To erase all readings stored in memory, see Program P1.0 on the next page.

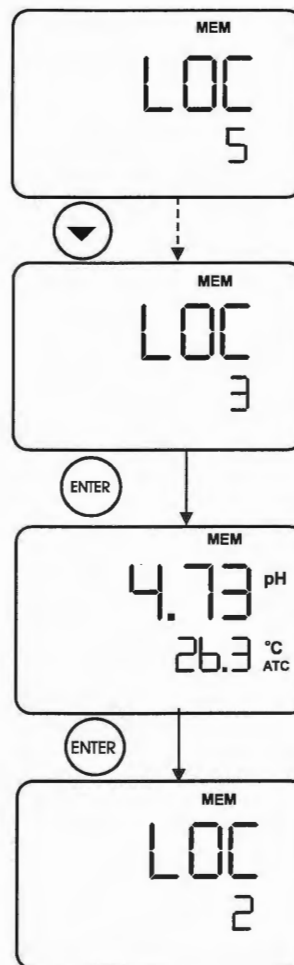

5 SETUP FUNCTIONS

The advanced SETUP mode lets you customize your meter's preferences and defaults:

- P1.0:** Memory Clear (Clr)
- P2.0:** Viewing electrode data (ELE)
- P3.0:** Selecting buffer sets (bUF)
- P4.0:** Reset to factory default settings (rSt)

To enter the SETUP mode:

1. Turn meter **OFF**.
2. With meter off, press and hold the **MODE** key, and press and release the **ON** key. The display will show the [SETUP] indicator. If the display indicates you are in the measurement mode turn the meter off and try step 2 again until [SETUP] appears.

NOTE: To exit the SETUP mode at anytime without confirming changes press **CAL/MEAS** until the measurement mode appears. You may have to press **CAL/MEAS** key two times before the meter reverts to the measurement mode.

5.1 P1.0 Clear Memory

Use this program to clear all memory values when you need to store a new series of values. This lets you avoid confusing the old values with the new ones. NO is the default setting.

1. Enter the SETUP mode as described above. The meter automatically goes to program P1.0. Clr appears in the upper display and P1.0 in the lower display.
2. Press the **ENTER** key to access the program and the lower display shows either "nO" or "YES" (depending on last option selected or factory default i.e. nO).
3. Use **▲** or **▼** key to toggle between "nO" or "YES"
4. Press **ENTER** key to confirm selection and return to the SETUP mode. To continue to the next SETUP, press **▲** or **▼** key to select a new program. Otherwise press the **CAL/MEAS** key to return to the measurement mode.

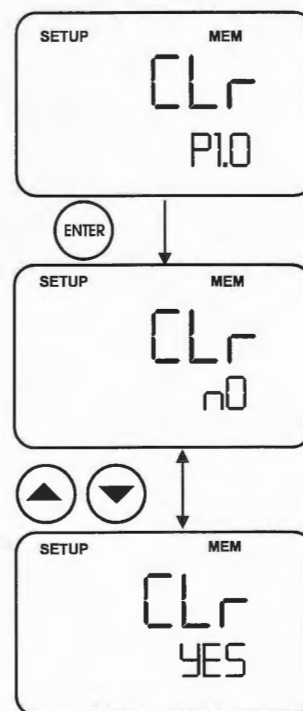

5.2 P2.0 Viewing Electrode Diagnosis

This program lets you check the electrode parameters for diagnostic purposes. Depending on the last display mode, displayed electrode information varies. Only these readings can be viewed:

Last Display Mode	Electrode Property	
	Offset	Slope
pH	in mV	%
Ion	-	in mV
mV	in mV	-

1. Enter the SETUP mode as described above. The meter automatically goes to program 1.0.
2. Press \blacktriangle or \blacktriangledown key to scroll through the programs until you view ELE in the upper display and P2.0 in the lower display. The electrode annunciator also appears.
3. Press **ENTER** key to access the program P2.0. The lower display will read P2.1.

The information you will see in Program P2.0 will depend upon which MODE the meter was in prior to shutting the meter off:

In the pH measurement MODE:

P2.1 shows the mV offset of the electrode. Press **ENTER** key to go to P2.2 (see Figure 8).

P2.2 shows the slope in % of the electrode.

In the mV measurement MODE:

P2.1 shows the mV offset of the electrode (see Figure 9).

In the Ion measurement MODE:

P2.1 shows the average slope of the electrode (see Figure 10).

4. To exit P2.0 program press **ENTER** key until ELE is in the upper display and P2.0 is in the lower display. Press \blacktriangle or \blacktriangledown key to select a new program OR press **CAL/MEAS** key to return to the measurement mode.

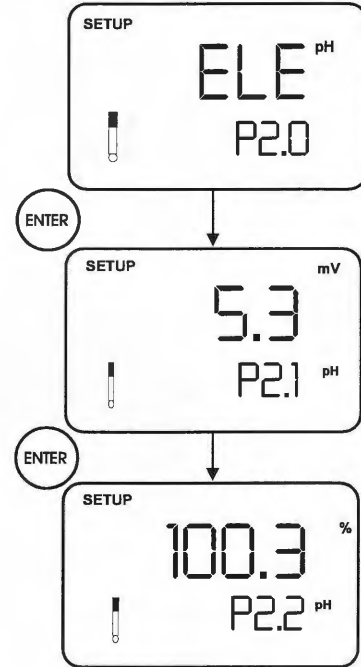

Figure 8: slope in %

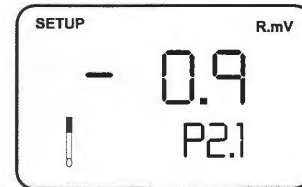

Figure 9: mV offset



Figure 10: Average slope (mV)

5.3 P3.0 Selecting pH Buffer Standard

This program lets you select between two standard calibration buffer sets, depending upon your requirements.

The available standards are USA and NIST.

1. Enter the SETUP mode as described in this section earlier. The meter automatically goes to program P1.0.
2. Press Δ or ∇ key to scroll through the programs until you view "bUF" in the upper display and P3.0 in the lower display. The buffer annunciator also appears.
3. Press **ENTER** key to access the program P3.0. The lower display will read either "USA" or "nSt" (depending on the previous setting you have made; factory default is USA.)
4. Press Δ or ∇ key to select the buffer set you require:
 - USA buffers: 4.01, 7.00 and 10.01
 - nSt buffers: 4.01, 6.86 and 9.18
5. To confirm the buffer standard, press **ENTER**. All the characters on the display will flash momentarily and then returns to P3.0.
6. To exit P3.0 program press Δ or ∇ key to select a new program OR press the **CAL/MEAS** to return to the measurement mode.

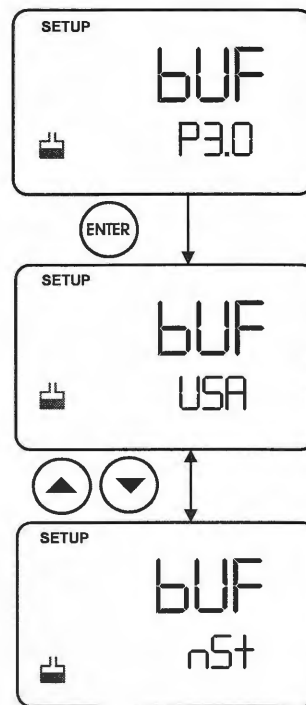

5.4 P4.0 Meter Reset

This program resets and clears all memory data and calibration data except temperature calibrated value which will be retained. NO is the default setting.

1. Enter the SETUP mode as described in this section earlier on. The meter automatically goes to program P1.0.
2. Press Δ or ∇ key to scroll through the programs until you view rSt in the upper display and P4.0 in the lower display. The mV and pH annunciators also appears.
3. Press the **ENTER** key to access the program P4.0. The lower display will read **NO**.
4. Press Δ or ∇ key to select "NO" or "YES". Select **YES** erases all calibration values for all modes (pH, mV and ion) and all memory values.
5. To confirm the reset, make sure **YES** is selected and press **ENTER**. All the characters on the display will flash for a second then the meter returns to the measurement mode.

NOTE

Once YES is selected and ENTER key is pressed; the reset program clears all old calibration data and memory data. The data is no longer retrievable. You must calibrate the meter before taking any new measurements. Meter will however retain buffer set selection (NIST or USA).

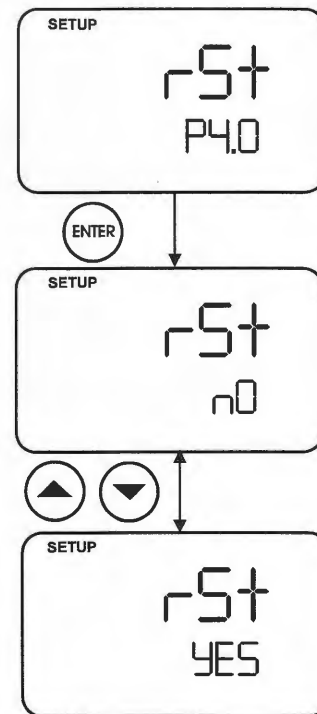

6 pH ELECTRODE MAINTENANCE

pH electrodes are susceptible to dirt and contamination and need to be cleaned regularly depending on the extent and condition of use. Refer to Section 6.3 for more details on cleaning pH electrode.

6.1 Storage

For best result, always keep the pH electrode bulb wet, preferably with the use of storage solution. pH 4 buffer is also acceptable as a storage medium. Do not store in deionized water. The protective rubber cap or container filled with the buffer solution provides ideal storage for long periods.

6.2 After Use

After measurement is complete, follow the sequence below for storage.

- Wash the electrode and reference junction in de-ionized water
- If using a refillable electrode, close the refilling hole by returning its rubber sleeve or stopper cap into position.
- Store the electrode as mentioned above (see Storage).

6.2.1 Electrolyte Replacement (for refillable electrodes only)

The reference electrolyte needs to be refilled when the pH electrode has been used for an extended period, or when the internal electrolyte has dried up. To accomplish this, follow the procedure:

- Remove the protective rubber cap or sleeve to expose the filling port of the electrode. Remove the old reference electrolyte by flushing out with a syringe and a flexible tube.
- Add in fresh electrolyte until it reaches the level of the refilling port. The reference electrolyte depends on your electrode. For double junction or Calomel electrodes, the electrolyte should be 4M KCl (EC-RE001/05992-48). Replace the rubber sleeve.

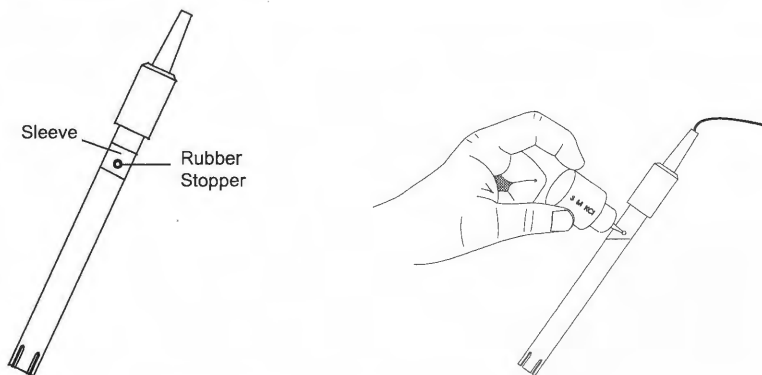

- Rinse the liquid junction with de-ionized water and gently tap dry.

NOTE

If these steps fail to restore normal electrode response, you may attempt to rejuvenate it. (See: 6.4 pH Electrode Rejuvenation).

6.3 Electrode Cleaning

pH electrodes that are mechanically intact and not in use for a short period of time can be restored to normal performance by one or a combination of following procedures:

a) Salt deposits

Dissolve the salt deposits by immersing the electrode in a container filled with some tap water for ten to fifteen minutes. Then thoroughly rinse with de-ionized water.

b) Oil / Grease Films

Wash the pH electrode bulb in mild detergent and water. Rinse electrode tip with de-ionized water.

c) Clogged Reference Junction

Heat a dilute 1% KCl solution to 60-80 °C. Place the sensing portion of the pH electrode into heated KCl solution for approximately 10 minutes (as shown above). Care must be taken when performing this procedure. Allow electrode to cool while immersing in some unheated KCl solution. (Heating time confirmed at 10 minutes on our side, pls take note)

d) Protein Deposits

Use Protein Cleaning Solution (EC-DPC-BT/ 00653-06) to remove any protein that is deposited onto pH electrode. Allow the electrode to stand in this solution for five to ten minutes.

6.4 pH Electrode Rejuvenation

CAUTION: Proper protective eyewear and precautionary measures must be used when performing the rejuvenation procedure as it involves the use of concentrated acid and alkaline.

Generally, if procedure of storage and maintenance had been closely followed, the pH electrode can be used immediately. However, should the electrode response become sluggish, it may be possible that the glass bulb has dehydrated. Immersing the electrode in an ideal storage solution (e.g. buffer pH 4 solution) for 1- 2 hours can dehydrate the glass bulb. If this fails, the electrode may require re-activation. At no time should you touch or rub the glass bulb as this causes the build-up of electrostatic charge. If the above procedure does not re-activate electrode to acceptable status, try rejuvenating electrode by following the procedure outlined below.

6.4.1 Rejuvenation Procedure



1. Dip and stir the electrode in freon or alcohol for 5 minutes.
2. Leave the electrode in tap water for 15 minutes.
3. Dip and stir the electrode in concentrated acid (e.g. HCl, H₂SO₄) for 5 minutes.
4. Repeat Step 2.
5. Dip and stir in strong base (NaOH) for 5 min. Leave for 15 minutes in tap water.
6. Test with standard calibration buffer solutions.

Finally, test with standard calibration buffer solutions to see if the electrode yields acceptable results. You may repeat steps 3-6 again for better response (maximum 3 times). If the response does not improve, then the electrode has completed its useful life. Replace with a new electrode.

7 TROUBLESHOOTING GUIDE

7.1 Error Messages

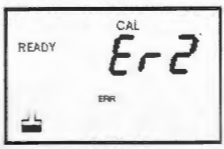
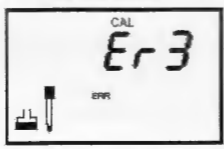
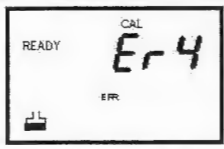
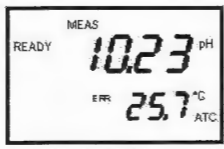
The table provides a quick guideline for diagnosis of possible problems indicated by the messages generated by the 510 meter series. The table also provides possible solutions to problems encountered. Diagrams inserted below.

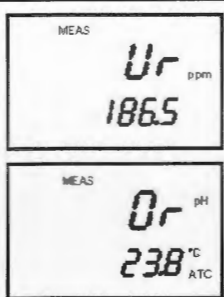
Display Screen	ERROR MESSAGE	INDICATES	CAUSE	CORRECTIVE ACTION
	Err. 2 (in upper display) during Ion calibration	Too few calibration points	Meter calibrated with only 1-point in ion calibration	Recalibrate using 2 or more points
	Err. 3 (in upper display) during Ion calibration	Slope error	Ion calibration solution not within acceptable range (15mV to 90mV/decade)	Recalibrate using fresh ion solutions Replace electrode.
	Err. 4 (in upper display) during Ion calibration	Calibration points more than 1 decade apart	Calibration points more than 1 decade apart	Recalibrate using calibration points 1 decade apart.
	Err (annunciator)	Wrong keypad input	Button does not work in the current operation mode	Release key. Select valid buttons depending on mode.
	Electrode icon (indicator)	Calibration error	Buffer value does not match value displayed or electrode is disconnected or failing	Use fresh buffer solution or check electrode connection. Possibly replace electrodes.
	Ur or Or (in upper display)	Measured value is out of range	Electrode not connected Electrode clogged, dirty or broken Meter not calibrated. Measurement is under range or over range	Make sure electrode is connected Clean or replace electrode Recalibrate the meter. Treat samples to bring within meter measuring range

7.2 Troubleshooting

PROBLEM	PROBABLE CAUSE	REMEDIAL ACTION
No display	a) Mains power not switched on. b) AC Adapter socket not inserted properly.	a) Switch on the power supply. b) Re-insert AC Adapter socket.
Unstable reading	a) Insufficient reference electrolyte in electrode.	a) Fill electrode with reference electrolyte.
	b) Broken electrode	b) Replace electrode.
	c) External 'noises' or induction (e.g. electrical 'noise' caused by a nearby motor)	c) Remove or switch off interfering device.
	d) Dirty electrode.	d) Clean the electrode. Hydrate, then rejuvenate if necessary.
Slow response	a) Dirty electrode.	a) Clean electrode. Hydrate, then rejuvenate if necessary.
Meter not responding to key press	a) HOLD mode in operation.	a) Cancel HOLD mode. Press Hold button.
	b) Internal program error.	b) Reset all internal programs by removing and reinserting the A/C adapter.

8 ADDITIONAL INFORMATION

8.1 pH and Temperature

Automatic Temperature Compensation (ATC) compensates for temperature changes. Some solutions show an increase while others a decrease in pH with the same temperature change. Record the solution temperature along with the pH value, or the measurement may be meaningless. Temperature changes also affect the signal the pH electrode sends to the meter and causes a loss of accuracy for the reading. To limit the loss of accuracy during calibration, make the temperature of the pH buffer calibrating solutions and the sample solution the same.

8.2 Use of Standard pH Buffers

Use standard buffer solutions to calibrate a pH meter before you measure the pH of a sample. They serve as reference standards for basis of comparison between measurements. The most common USA standard buffers are the pH 4.01, pH 7.00 and pH 10.01 and the NIST standard buffers are pH 4.01, pH 6.86 and pH 9.18. For 1-point calibration, use a standard buffer of pH 7.00 or a standard buffer whose pH value is close to that of the sample. Use 2-point calibration when you know the sample is acidic (low pH) or basic (high pH). For acidic samples, use standard buffers of pH 7.00 and pH 4.01. For basic samples, use standards of pH 7.00 and pH 10.01. Use a 3-point calibration when the sample pH is completely unknown. Use all pH 7.00, pH 4.01 and pH 10.01 calibration solutions.

8.3 Standard pH Buffers

The following table shows the various pH values at different temperature of the solution during calibration. The table also illustrates why a calibration value may be different from the buffer value at 25°C.

Temperature (°C)	USA Buffer			NIST Buffer		
	pH 4.01	pH 7.00	pH 10.01	pH 4.01	pH 6.86	pH 9.18
0	4.01	7.12	10.32	4.01	6.95	9.17
5	4.01	7.09	10.25	4.01	6.95	9.38
10	4.00	7.06	10.18	4.00	6.92	9.32
15	4.00	7.04	10.12	4.00	6.90	9.27
20	4.00	7.02	10.06	4.00	6.88	9.22
25	4.01	7.00	10.01	4.01	6.86	9.18
30	4.01	6.99	9.97	4.01	6.85	9.14
35	4.02	6.98	9.93	4.02	6.84	9.10
40	4.03	6.97	9.89	4.03	6.84	9.07
45	4.04	6.97	9.86	4.04	6.83	9.04
50	4.06	6.97	9.83	4.06	6.83	9.01
55	4.08	6.97	9.81	4.08	6.83	8.99
60	4.10	6.98	9.79	4.10	6.84	8.96
70	4.12	6.99	9.76	4.12	6.85	8.92
80	4.16	7.00	9.74	4.16	6.86	8.89
90	4.20	7.02	9.73	4.20	6.88	8.85

8.4 Specifications

Description		pH 510	Ion 510
pH Range	0.00 to 14.00 pH	✓	✓
Resolution	0.01 pH	✓	✓
Accuracy	± 0.01 pH + 1 count	✓	✓
Ion Concentration Range	0.01 to 1999 ppm		✓ (± 500mV input)
Resolution	0.01 pm (0.01 to 0.99 ppm); 0.1 ppm (1.0 to 199.9 ppm); 1 ppm (200 to 1999 ppm)		✓
Accuracy	±0.5% Full Scale for mono-valent ions ±1.0 % Full Scale for di-valent ions		✓
mV Range	Yes	✓ ± 1999 mV	✓ ± 500mV(Absolute) ±1999mV(Relative)
Resolution	0.1 mV (± 199.9 mV), 1 mV beyond ± 200 mV	✓	✓
Accuracy	± 0.2 mV (± 199.9 mV), ± 2 mV beyond ± 200 mV	✓	✓
Calibration Offset Adjustment	Up to ±150 mV	✓	✓
Temperature Range	0.0 to 100.0 °C	✓	✓
Resolution	0.1 °C	✓	✓
Accuracy	± 0.3 °C	✓	✓
Temperature Compensation	Automatic / Manual (0 to 100 °C)	✓	✓
No. of pH Calibration Points	Up to 3 points with Auto-buffer recognition	✓	✓
pH Buffer Calibration Options	USA : pH 4.01, 7.00, 10.01; NIST: pH 4.01, 6.86, 9.18	✓	✓
No. of Ion Calibration Points	Up to 3 points (minimum 2 points)		✓
Ion Calibration Options	0.1, 1.0, 10.0 or 100.0 ppm		✓
Min. & Max. Slope during Calibration	15 mV/decade to 90 mV/decade		✓
Temperature Calibration	Offset in 0.1 °C increments; Offset range: ± 5 °C	✓	✓
Memory	50 data sets	✓	✓
Hold Function	Yes	✓	✓
Self-diagnostic Messages	Yes	✓	✓
pH Slope and Offset Display	Yes	✓	✓
Inputs	BNC, Phono, Ref. (Half-cell), Ground	✓	✓
Output	Recorder (+/- 2000 mV)	✓	✓
Power Requirements	AC/DC 9V Adapter (110 VAC/220 VAC, 50-60Hz)	✓	✓
Display	Custom Dual LCD (1 x 4 digits, 1 x 3.5 digits, annunciators)	✓	✓
Dimensions / Weight	Meter with electrode holder: 18 x 23 x 6 cm / 1250 g Boxed (meter with electrode holder): 40 x 26 x 9 cm / 1950 g	✓	✓

9 WARRANTY

This bench meter is supplied with a **3-year** warranty from manufacturing defects and electrodes for **6 months** from the date of purchase.

If repair or adjustment is necessary and has not been the result of abuse or misuse within the designated period, please return – freight pre-paid – and correction will be made without charge. Fisher Science Education will determine if the product problem is due to deviations or customer misuse.

Out of warranty products will be repaired on a charged basis.

Exclusions

The warranty on your instrument shall not apply to defects resulting from:

- Improper or inadequate maintenance by customer
- Unauthorized modification or misuse
- Operation outside of the environment specifications of the products

10 RETURN OF ITEMS

Authorization must be obtained from our Customer Service Department or authorized distributor before returning items for any reason. A "Return Goods Authorization" (RGA) form is available through our Authorized Distributor. Please include data regarding the reason the items are to be returned. For your protection, items must be carefully packed to prevent damage in shipment and insured against possible damage or loss. Fisher Science Education will not be responsible for damage resulting from careless or insufficient packing. A restocking charge will be made on all unauthorized returns.

NOTE: Fisher Science Education reserves the right to make improvements in design, construction, and appearance of products without notice.