
Chapter 3. Test Procedures – For Packages Labeled by Volume

3.1. Scope

Use these procedures to determine the net contents of packaged goods labeled in fluid volume such as milk, water, beer, oil, paint, distilled spirits, soft drinks, juices, liquid cleaning supplies, or chemicals. This chapter also includes procedures for testing the capacities of containers such as paper cups, bowls, glass tumblers, and stemware.

These procedures do not cover berry baskets and rigid-dry measures that are covered by specific code requirements in NIST Handbook 44 “Specifications, Tolerances, and Other Technical Requirements for Weighing and Measuring Devices.”

If Multiunit or Variety Packages are to be inspected, refer to Chapter 5. “Specialized Test Procedures” for guidance in testing. If a total quantity declaration is being verified and the MAV to be applied is not based on a percentage of the labeled quantity, refer to Section 1.2.4.1. “Total Quantity MAV for Multiunit and Variety Packages.”

(Note Added 2022)

3.1.1. Test Methods

The gravimetric procedure may be used to verify the net quantity of contents of packages labeled in volume when the density (density means the weight of a specific volume of liquid determined at a reference temperature) of the product being tested does not vary excessively from one package to another.

If the density varies from one package to another, test each package using the volumetric test procedures described in this chapter. Special test methods are required for a number of unique products so care should be taken to select the correct test procedure.

Reference Temperature:

In addition to possible package-to-package variations in product density, the temperature of the liquid will affect the volume. The product will expand or contract based on a rise or fall in product temperature.

Example:

The volume of a liquid cleaning product might be 5 L (1.32 gal) at 20 °C (68 °F) and 5.12 L (1.35 gal) at 25 °C (77 °F), which represents a 2.2 % change in volume.

Notes:

- (1) This extreme example is for illustrative purposes. A 2.2 % volume change will not occur in normal testing.

Use the reference temperature specified in Table 3-1. “Reference Temperatures for Liquids” to determine volume. When checking liquid products labeled by volume using the gravimetric procedure, maintain the packages used to determine product densities at reference temperatures. If testing the packages in a sample volumetrically, each package in the sample must be maintained at or corrected to the reference temperature when its volume is determined.

- (2) When checking liquid products using a volumetric or gravimetric procedure, the temperature of the samples must be maintained at the reference temperature ± 2 °C (± 5 °F).

Table 3-1. Reference Temperatures for Liquids		
If the liquid commodity is:	Volume is determined at the reference temperature of:	Code of Federal Regulation (CFR) Reference*
Malt (Beer)	4 °C (39.1 °F)	27 CFR 7.10
Distilled Spirits	15.56 °C (60 °F)	27 CFR 5.11
Frozen food - sold and consumed in the frozen state	At the frozen temperature	21 CFR 101.7(b)(2)(i)
Petroleum	15.6 °C (60 °F)	16 CFR 500.8(b)
Refrigerated food (e.g., milk and other dairy products labeled “KEEP REFRIGERATED”)	4 °C (40 °F)	21 CFR 101.7(b)(2)(ii)
Other liquids and wine (e.g., includes liquids sold in a refrigerated state for immediate customer consumption such as soft-drinks, bottled water and others that do not require refrigeration)	20 °C (68 °F)	Food: 21 CFR 101.7(b)(2)(iii) Non-Food: 16 CFR 500.8(b) Wine: 27 CFR 4.10 (b)
*The Code of Federal Regulations (CFR) can be accessed online at: www.ecfr.gov or www.govinfo.gov/app/collection/cfr .		

(Amended 2010)

3.2. Gravimetric Test Procedure for Non-Viscous Liquids

3.2.1. Test Equipment

- A scale that meets the requirements in Chapter 2, Section 2.2. “Measurement Standards and Test Equipment.”

Note: To verify that the scale has adequate resolution for use, it is first necessary to determine the density of the liquid; next verify that the scale division is no larger than MAV/6 for the package size under test. The smallest graduation on the scale must not exceed the weight value for MAV/6 (see Example for Determining Scale Suitability).

Example:

Assume the inspector is using a scale with 1 g (0.002 lb) increments to test packages labeled 1 L (33.8 fl oz) that have an MAV of 29 mL (1 fl oz). Also, assume the inspector finds that the weight of 1 L of the liquid is 943 g (2.078 lb). This will result in an MAV/6 value in weight of 4.557 g (0.010 lb):

Example for Determining Scale Suitability (based on the example above)		
1. Determine the MAV based on the labeled quantity.	MAV: 29 mL	MAV: 1 fl oz
2. Determine the density of the liquid.	Density: 1 Liter = 943 g $\div 1000 \text{ mL} = 0.943 \text{ g/mL}$	Density: 33.8 fl oz = 2.078 lb $\div 33.8 \text{ fl oz} = 0.0614 \text{ lb/fl oz}$
3. Convert the MAV from volume to weight by multiplying the (volume) MAV by the density factor (step 2). Divide this result by 6 (MAV/6) and compare it to the scale division.	MAV in Volume Converted to Weight Divided by 6. $29 \text{ mL} \times 0.943 \text{ g/mL} \div 6 = 4.557 \text{ g}^*$	MAV in Volume Converted to Weight Divided by 6. $1 \text{ fl oz} \times 0.0614 \text{ lb/fl oz} \div 6 = 0.010 \text{ lb}$
*In this example, the 1 g (0.002 lb) scale division is smaller than the MAV/6 value of 4.557 g (0.010 lb) so the scale is suitable for making a density determination.		

- Partial immersion thermometer or equivalent with 1 °C (2 °F) graduations and a – 35 °C to + 50 °C (– 30 °F to + 120 °F) accurate to ± 1 °C (± 2 °F).
- Volumetric measures

Note: When checking packages labeled in SI units, flask sizes of 100 mL, 200 mL, 500 mL, 1 L, 2 L, 4 L, and 5 L and a 50 mL cylindrical graduate with 1 mL divisions may be used. When checking packages labeled in U.S. customary units the use of measuring flasks and graduates with capacities of gill, half-pint, pint, quart, half-gallon, gallon, and a 2 fl oz cylindrical graduate, graduated to 1/2 fl dr is recommended.

- Defoaming agents may be necessary for testing liquids such as beer and soft drinks that effervesce or are carbonated. Two such products are Hexanol or Octanol (Capryl Alcohol).
- Bubble level at least 152 mm (6 in) in length
- Stopwatch

3.2.2. Test Procedure

1. Follow Section 2.3.1. “Define the Inspection Lot.” Use a “Category A” sampling plan in the inspection. Select a random sample.
2. Bring the sample packages and their contents to the reference temperature as specified in Table 3-1. “Reference Temperatures for Liquids.” To determine if the liquid is at its reference temperature, immerse the thermometer in the liquid before starting the test. Verify the

This publication is available free of charge from: <https://doi.org/10.6028/NIST.HB.133-2023>

temperature again immediately after the flask and liquid is weighed. If the product requires mixing for uniformity, mix it before opening in accordance with any instructions specified on the package label. Shaking liquids, such as flavored milk, often entraps air that will affect volume measurements, so use caution when testing these products. Often, less air is entrapped if the package is gently rolled to mix the contents.

3. For milk, select a volumetric measure equal to or one size smaller than the label declaration. For all other products, select a volumetric measure that is one size smaller than the label declaration.

(Amended 2004)

Example:

If testing a 1 L bottle of juice or a soft drink, select a 500 mL volumetric measure.

Note: When determining the density of milk, if the product from the first container does not fill the volumetric measure to the nominal capacity graduation, product may be added from another container as long as product integrity is maintained (i.e., brand, identity, lot code, and temperature).

4. Prepare a clean volumetric measure to use according to the following procedure:
 - Because flasks are ordinarily calibrated on a “to deliver” basis, they must be “wet down” before using. Immediately before use, fill the volumetric flask(s) or graduate with water. The water should be at the reference temperature of the product being tested. Fill the flask(s) with water to a point slightly below the top graduation on the neck. The flask should be emptied in 30 seconds (± 5 seconds). Tilt the flask gradually so the flask walls are splashed as little as possible as the flask is emptied. When the main flow stops, the flask should be nearly inverted. Hold the flask in this position for 10 seconds more and touch off the drop of water that adheres to the tip. If necessary, dry the outside of the flask. This is called the “wet down” condition. The flask or graduate is then ready to fill with liquid from a package.

Note: When using a volumetric measure that is calibrated “to contain,” the measure must be dry before each measurement.

- If the liquid effervesces or foams when opened or poured (such as carbonated beverages), add two drops of a defoaming agent to the bottom of the flask before filling with the liquid. If working with a carbonated beverage, make all density determinations immediately upon placing the product into the standard. This reduces the chance of volume changes occurring from the loss of carbonization.
5. If the flask capacity is equal to the labeled volume, pour the liquid into the volumetric measure tilting the package to a nearly vertical position. If the flask capacity is smaller than the package’s labeled volume, fill the flask to its nominal capacity graduation.
 6. Position the flask on a level surface at eye level. For clear liquids, place a material of some dark color outside the flask immediately below the level of the meniscus. Read the volume from the lowest point of the meniscus. For opaque liquids, read volume from the center top rim of the liquid surface.
 7. Evaluate the density variation.

- Select a volumetric measure equal to or one size smaller than the labeled volume (depending on the product) and prepare it as described in Step 4 of this section. Then determine and record its empty weight.
- Determine acceptability of the liquid density variation, using two packages as follows:
 - Determine the gross weight of the first package.
 - Pour the liquid from the first package into a flask. Measure exactly to the nominal capacity marked on the neck of the measure.
 - Weigh the filled flask and subtract its empty weight to obtain the weight of the liquid. Determine density by dividing the weight of the liquid by the capacity of the flask.
 - Determine the weight of the liquid from a second package using the same procedure.
 - If the difference between the densities of the two packages exceeds one division, use the volumetric procedure in Section 3.3. “Volumetric Test Procedure for Non-Viscous Liquids.”
- 8. Determine the Average Used Dry Tare Weight of the sample according to provisions of Section 2.3.5. “Procedures for Determining Tare.”
- 9. Calculate the Average Product Density by adding the densities of the liquid from the two packages and dividing the sum by two.
- 10. Calculate the “nominal gross weight” using the following formula if the flask capacity is equal to the labeled volume:

$$\textit{Nominal Gross Weight} = (\textit{Average Product Density [in weight units]}) + (\textit{Average Used Dry Tare Weight})$$

Note: If the flask size is smaller than the labeled volume, the following formula is used:

$$\textit{Nominal Gross Weight} = (\textit{Average Product Density} \times [\textit{Labeled Volume/Flask Capacity}]) + (\textit{Average Used Dry Tare Weight})$$

- 11. Weigh the remaining packages in the sample.
- 12. Subtract the nominal gross weight from the gross weight of each package to obtain package errors in terms of weight. All sample packages are compared to the nominal gross weight.
- 13. To convert the average error or package error from weight to volume, use the following formula:

$$\textit{Package Error in Volume} = \textit{Package Error in Weight} \div \textit{Average Product Density Per Volume Unit of Measure.}$$

3.2.3. Evaluation of Results

Follow the procedures in Chapter 2, Section 2.3.7. “Evaluate for Compliance” to determine lot conformance.

3.3. Volumetric Test Procedure for Non-Viscous Liquids

If it is determined that the densities of the liquids vary beyond the specified limit, use the volumetric test procedure below to test the product.

3.3.1. Test Equipment

- Partial immersion thermometer or equivalent with 1 °C (2 °F) graduations and a – 35 °C to + 50 °C (– 30 °F to + 120 °F) accurate to ± 1 °C (± 2 °F).
- Volumetric measures

Note: When checking packages labeled in SI units, flask sizes of 100 mL, 200 mL, 500 mL, 1 L, 2 L, 4 L, and 5 L and a 50 mL cylindrical graduate with 1 mL divisions may be used. When checking packages labeled in U.S. customary units the use of measuring flasks and graduates with capacities of gill, half-pint, pint, quart, half-gallon, gallon, and a 2 fl oz cylindrical graduate, graduated to $\frac{1}{2}$ fl dr is recommended.

- Defoaming agents may be necessary for testing liquids such as beer and soft drinks that effervesce or are carbonated. Two such products are Hexanol or Octanol (Capryl Alcohol).
- Bubble level at least 152 mm (6 in) in length
- Stopwatch

3.3.2. Test Procedure

1. Follow Steps 1 through 6 in Section 3.2. “Gravimetric Test Procedure for Non-Viscous Liquids” for each package in the sample.
2. In Step 5, drain the container into the flask for one minute after the stream of liquid breaks into drops.
3. Read the package errors directly from the graduations on the measure. The reference temperature must be maintained within ± 2 °C (± 5 °F) for the entire sample.

3.3.3. Evaluation of Results

Follow the procedures in Chapter 2, Section 2.3.7. “Evaluate for Compliance” to determine lot conformance.

3.4. Volumetric Test Procedures for Viscous Fluids – Headspace

Depending on how level the surface of the commodity is, use one of the two headspace test procedures. Use Section 3.4.2.a. “Test Procedure for Testing Oils, Syrups, and other Viscous Liquids with a Smooth and Level Surface” to determine volume where the liquid has a level surface (e.g., oils, syrups, and other

viscous liquids). Use Section 3.4.2.b. “Test Procedure for Testing Mayonnaise, Salad Dressing, and Water Immiscible Products with no Smooth and Level Surface” to determine volume where the commodity does not have a level surface (e.g., mayonnaise and salad dressing).

Before conducting either of the following volumetric test procedures, follow Section 2.3.1. “Define the Inspection Lot.” Use a “Category A” sampling plan in the inspection; select a random sample.

(Amended 2019)

3.4.1. Test Equipment

- Micrometer depth gage (ends of rods may be flat or fully rounded) 0 mm to 225 mm (0 in to 9 in) or longer.
- Level (at least 152 mm [6 in] in length)
- Laboratory pipets and/or buret
 - Class A 100 mL buret as defined by the latest version of ASTM E287, “Standard Specification for Laboratory Glass Graduated Burets.”
 - Class A pipets, calibrated “to deliver “as defined by the latest version of ASTM E969, “Standard Specification for Glass Volumetric (Transfer) Pipets.”
- Volumetric measures
- Distilled Water or Reverse Osmosis Water (for use with laboratory pipets and/or burets)
- Water
- Rubber bulb syringe
- Plastic disks that are 3 mm ($1/8$ in) thick with diameters equal to the seat diameter or larger than the brim diameter of each container to be tested. The diameter tolerance for the disks is 50 μm (± 0.05 mm [± 0.002 in]). The outer edge should be smooth and beveled at a 30° angle with the horizontal to 800 μm (0.8 mm [$1/32$ in]) thick at the edge. Each disk must have a 20 mm ($3/4$ in) diameter hole through its center and a series of 1.5 mm ($1/16$ in) diameter holes 25 mm (1 in) apart around the periphery of the disk and 3 mm ($1/8$ in) from the outer edge. All edges must be smooth.
- Stopwatch
- Partial immersion thermometer (or equivalent) with 1 °C (2 °F) graduations and a range of – 35 °C to + 50 °C (– 30 °F to + 120 °F) accurate to ± 1 °C (± 2 °F)

(Amended 2019)

3.4.2. Test Procedures

a. Test Procedure for Testing Oils, Syrups, and other Viscous Liquids with a Smooth and Level Surface

Use the volumetric headspace procedure described in this section to determine volume when the commodity has a level surface. Open every package in the sample.

1. Bring the temperature of both the liquid and the water to be used to measure the volume of the liquid to the reference temperature specified in Table 3-1. “Reference Temperatures for Liquids.” Verify with a thermometer that the product has maintained the reference temperature.
2. Place the package on a level surface and open it. Measure the headspace of the package at the point of contact with the liquid using a depth gage. If necessary, support the package to prevent deflection in the bottom of the container that may affect the volume.
3. Empty, clean, and dry the package.
4. Refill the container with water measured from a volumetric standard to the original liquid headspace level measured in Step 2 of this procedure until the water touches the depth gage.
5. Determine the amount of water used in Step 4 of this procedure to obtain the volume of the liquid and calculate the “package error” based on that volume.

$$\text{“Package Error”} = \text{Labeled Value} - \text{Measured Volume}$$

b. Test Procedure for Testing Mayonnaise, Salad Dressing, and Water Immiscible Products with no Smooth and Level Surface

Use the following volumetric headspace procedure to determine volume when the commodity does not have a level surface (e.g., mayonnaise, salad dressing, and other water immiscible products without a level liquid surface). The procedure guides the inspector to determine the amount of headspace above the product in the package and the volume of the container. Determine the product volume by subtracting the headspace volume from the container volume. Open and test every package in the sample.

(Amended 2010)

Note: Make all measurements on a level surface.

1. Bring the temperature of both the commodity and the water used to measure the volume to the appropriate temperature designated in Table 3-1. “Reference Temperatures for Liquids.”
2. Open the first package and place a disk larger than the package container opening over the opening.
3. Measurement Procedure:
 - Deliver water from a flask (or flasks), graduate, or buret, through the central hole in the disk onto the top of the product until the container is filled. If it appears that the contents of the flask may overflow the container, do not empty the flask. Add water until all of the

air in the container has been displaced and the water begins to rise in the center hole of the disk. Stop the filling procedure when the water fills the center disk hole and domes up slightly due to the surface tension. Do not add additional water after the level of the water dome has dropped.

- If the water dome breaks on the surface of the disk, the container has been overfilled and the test is void; dry the container and start over.
4. To obtain the headspace capacity, record the volume of water used to fill the container and subtract 1 mL (0.03 fl oz), which is the amount of water held in the hole in the disk specified.
 5. Empty, clean, and dry the package container.
 6. Using Steps 3 and 4 of this procedure, refill the package container with water measured from a volumetric measure to the maximum capacity of the package, subtract 1 mL (0.03 fl oz), and record the amount of water used as the container volume; and
 7. From the container volume determined in Step 6 of this procedure, subtract the headspace capacity in Step 4 of this procedure to obtain the measured volume of the product.
 8. Calculate the “package error” for that volume where “package error” equals labeled volume minus the measured volume of the product.

3.4.3. Evaluation of Results

For either of the above procedures, follow the procedures in Section 2.3.7. “Evaluate for Compliance” to determine lot conformance.

3.5. Goods Labeled by Capacity – Volumetric Test Procedure

3.5.1. Test Equipment

Use the test equipment in Section 3.4. “Volumetric Test Procedures for Viscous Fluids – Headspace” (except for the micrometer depth gage) to perform this test procedure.

3.5.2. Test Procedure

Note: Make all measurements on a level surface.

1. Before conducting any of the following volumetric test procedures, refer to Section 2.3.1. “Define the Inspection Lot.” Use a “Category A” sampling plan in the inspection; select a random sample.
2. When testing goods labeled by capacity, use water at a reference temperature of $20\text{ }^{\circ}\text{C} \pm 2\text{ }^{\circ}\text{C}$ ($68\text{ }^{\circ}\text{F} \pm 5\text{ }^{\circ}\text{F}$).
3. Select a sample container and place a disk larger than the container opening over the opening.
4. Measurement Procedure:

- Add water to the container using flask (or flasks), graduate, or buret corresponding to labeled capacity of the container. If it appears that the contents of the flask may overflow the container, do not empty the flask. Add water until all of the air in the container has been displaced and the water begins to rise in the center hole of the disk. Stop filling the container when the water fills the center disk hole and domes up slightly due to the surface tension.
 - If the water dome breaks on the surface of the disk, the container has been overfilled and the test is void; dry the container and start over.
 - Record the amount of water used to fill the container and subtract 1 mL (0.03 fl oz) this is the amount of water held in the hole in the disk specified) to obtain the total container volume.
5. Test the other containers in the sample according to Steps 3 and 4 of this procedure.
 6. To determine package errors, subtract the total container volume obtained in Step 4 of this procedure from the labeled capacity of the container.

3.5.3. Evaluation of Results

Follow the procedures in Section 2.3.7. “Evaluate for Compliance” to determine lot compliance.

3.6. Pressed and Blown Glass Tumblers and Stemware

This handbook provides a tolerance to the labeled capacity of glass tumblers and stemware. The average requirement does not apply to these products. (see Table 3-2. “Allowable Differences for Pressed and Blown Glass Tumblers and Stemware.”)

3.6.1. Test Equipment

Use the test equipment in Section 3.4. “Volumetric Test Procedures for Viscous Fluids – Headspace” (except for the micrometer depth gage) to perform this test procedure.

3.6.2. Test Procedure

1. Follow Section 2.3.1. “Define the Inspection Lot” and determine which sampling plan to use in the inspection, select a random sample, and then use the volumetric test procedure in Section 3.5. “Goods Labeled by Capacity – Volumetric Test Procedure” to determine container capacity and volume errors.
2. Compare the individual container error with the allowable difference that applies in Table 3-2. “Allowable Differences for Pressed and Blown Glass Tumblers and Stemware.” If a package contains more than one container, all of the containers in the package must meet the allowable difference requirements in order for the package to pass.

Table 3-2. Allowable Differences for Pressed and Blown Glass Tumblers and Stemware	
Unit of Measure	
If the capacity in metric units is:	The allowable difference is:
200 mL or less	± 10 mL
More than 200 mL	± 5 % of the labeled capacity
If the capacity in U.S. customary units is:	Then the allowable difference is:
5 fl oz or less	$\pm \frac{1}{4}$ fl oz
More than 5 fl oz	± 5 % of the labeled capacity

3.6.3. Evaluation of Results

Count the packages in the sample with volume errors greater than the allowable difference and compare the resulting number with the number given in Column 3. (Appendix A, Table 2-11. “Sampling Plans and Accuracy Requirements for Packages Labeled by Low Count [50 or Fewer] and Packages Given Tolerances [Glass and Stemware]”)

- If the number of containers in the sample with errors exceeding the allowable difference exceeds the number allowed in Column 3, the lot fails.
- If the number of packages with errors exceeding the allowable difference is less than or equal to the number in Column 3, the lot passes.

Note: The average capacity error is not calculated because the lot passes or fails based on the individual volume errors. Take action on the individual units containing errors exceeding the allowable difference.

3.7. Volumetric Test Procedure for Paint, Varnish, and Lacquers – Non-Aerosol

The following procedure is used to verify the net quantity of contents of containers of paint, varnish, wood stains, sealants, lacquers or like products labeled by volume. For the purposes of this test procedure the term “paint” includes any liquid or product (i.e., varnish lacquers, and other coatings).

(Amended 2019)

3.7.1. Test Equipment

- A scale that meets the requirements in Section 2.2. “Measurement Standards and Test Equipment”
- Volumetric measures
- Partial immersion thermometer (or equivalent with 1 °C (2 °F) graduations and a range of – 35 °C to + 50 °C (– 30 °F to + 120 °F) accurate to ± 1 °C (± 2 °F)
- Micrometer depth gage (ends of rods may be flat or fully rounded), 0 mm to 225 mm (0 in to 9 in)
- Spanning bar, 25.4 mm \times 25.4 mm \times 304 mm or (1 in \times 1 in \times 12 in)

- Ruler, 304 mm (12 in)
- Paint solvent or other solvent suitable for the product being tested
- Cloth, 304 mm (12 in) square
- Wood, 50 mm (2 in) thick × 150 mm (6 in) wide × 300 mm (12 in) long
- Rubber mallet
- Metal disk or other appropriate shape, 6.4 mm (¼ in) thick and slightly smaller than the diameter of package container bottom
- Rubber spatula
- Level at least 152 mm (6 in) in length
- Distilled water or reverse osmosis water
- Micrometer (optional)
- Stopwatch

(Amended 2019)

3.7.2. Test Procedures

a. Plant Audit Test Procedure

Use the following procedure to conduct an audit inspection in a production facility. This method applies to containers in a sample that are the lightest in weight and likely to contain the smallest volume of product. Duplicate the level of fill with water in an empty unused container of the same dimensions and capacity as the one under test. Use this method to check any size rigid container, if the liquid level is within the measuring range of the depth gage. If any paint is clinging to the sidewall or lid, carefully scrape the paint into the container using a rubber spatula to ensure the full content volume is measured.

Note: Do not shake or invert the containers selected as the sample.

1. Follow Section 2.3.1. “Define the Inspection Lot” to determine which “Category A” sampling plan to use; select a random sample.

Note: The sample containers shall be identically labeled as to volume, brand, commodity, color, and lot.

2. Determine the gross weight of the sample container. Record the gross weight of the lightest and heaviest container.
3. Select the lightest container and place it on a level work surface and open it. Place a spanning bar and depth gage across the top center of the container. Lower the depth gage rod until its point touches the surface of the paint and lock the rod adjustment.

4. Obtain an empty, unused – undamaged container of the same type and capacity as the container under test from the packer. Place the container on a rigid level work surface and place a disk or other appropriate support under the bottom to prevent deflection.
5. Use a volumetric flask or cylinder to fill the container with water [water reference temperature $20\text{ }^{\circ}\text{C} \pm 2\text{ }^{\circ}\text{C}$ ($68\text{ }^{\circ}\text{F} \pm 5\text{ }^{\circ}\text{F}$)] to the largest labeled quantity declared on the container.
6. Place the spanning bar and depth gage (locked at the surface depth of the paint in the container measured in Step 3.) across the top center of the container. If the point of the depth gage is at or below the surface of the water added in Step 4. assume the container is not short measure. When the audit test indicates that a short measure may exist in the sample container, then use Section 3.7.2.b. “Compliance Test Procedure”.

(Added 2019)

b. Compliance Test Procedure

Use the following procedure when testing rigid containers of paint when they have failed the plant audit test. This procedure is used to test paint or other liquid whether testing is performed inside the plant or at retail.

Note: Do not shake or invert the containers selected as the sample.

1. Follow Section 2.3.1. “Define the Inspection Lot” to determine which “Category A” sampling plan to use; select a random sample.

Note: The sample containers shall be identically labeled as to the volume, brand, commodity, color, and lot. The steps noted with an (*) are required if there is paint adhering to the lid and it cannot be removed by scraping into the container.

2. Determine the gross weight of these containers and record in Column 2 of the “Example Worksheet for Determining Possible Violation in Checking Paint” (in this section). Select and test the containers in order of the lightest to the heaviest.
3. Record the labeled volume of the first tare sample package in Column 1 of the worksheet. Place the container on a level surface and use a circular (or appropriately shaped) metal or other solid disk to eliminate deflection in the bottom of the container and remove the lid. If paint clings to the lid of the container, scrape it off with a spatula and place back into the container.
4. *If paint that adheres to the lid cannot be completely removed then by scraping the paint into the container, determine the weight of the lid plus any adhering paint. Clean (dry) the paint lid with solvent and weigh again. Subtract the clean (dry) lid weight from the lid weight with paint (wet) to determine the weight of the paint adhering to the lid. Record this weight in Column 3.
5. Place the spanning bar and depth gage across the top center of the container. Mark the location of the spanning bar on the rim of the container. Lower the depth gage rod until the point touches the paint surface and lock the rod adjustment.
6. Empty and clean the sample container and lid with solvent; dry and weigh the container and lid. Record the tare weight in Column 5.

7. Set up the container in the same manner as in Step 3.
8. Place the spanning bar at the same location on the rim of the paint container as marked in Step 5. With the depth gage set as described in Step 5, deliver water into the container in known amounts until the water reaches the same level occupied by the paint as indicated by the depth gage. Record this volume of water (in mL or fl oz) in Column 6 of the worksheet. This is the volume occupied by the paint in the container. Follow Steps 9a, 10a, and 11a if scraping does not remove the paint from the lid. To determine if gravimetric testing can be used to test the other containers in the sample, follow only Steps 9, 10, and 11 when no paint adheres to the lid.
9. Subtract the weight of the container (Column 5) from the gross weight (Column 2) to arrive at the net weight of paint in the selected container. Record the net weight in Column 7 of the worksheet.
 - 9a.* Subtract the weight of the container (Column 5) and the weight of product on the lid (Column 3) from the gross weight (Column 2) to arrive at the net weight of paint in the container. Record in Column 7 (excluding the weight of the paint on the lid).
10. Calculate the weight of the labeled volume of paint (for the first container opened for tare).

$$\text{net weight (Column 7)} \times \text{labeled volume (Column 1)} \div \text{volume of paint in can (Column 6)}$$

Record this value in Column 8.

- 10a.* Calculate the package volume =

$$\frac{\text{volume in container (Column 6)} + (\text{lid weight [Column 3]} \times \text{volume in container [Column 6]})}{\text{net weight [Column 7]}}$$

Record it in Column 9 of the worksheet.

11. Calculate the package error. Use the following formula if paint does not adhere to the lid.

$$\text{Package error} = (\text{Column 6 value}) - (\text{labeled volume})$$

- 11a.* Use the following formula if paint does adhere to the lid and will not come off by scraping.

$$\text{Package error} = (\text{Column 9 value}) - (\text{labeled volume})$$

12. Repeat Steps 2 through 11 for the second package chosen or tare
(Amended 2010 and 2019)

Example Worksheet for Determining Possible Violation in Checking Paint (add additional rows as needed)								
1. Labeled Volume	2. Gross Weight	3. Lid Weight (Wet – Dry)	4. Liquid Level	5. Tare	6. Water Volume	7. Net Wt. = 2 – 5	8. Weight of Labeled Volume = $7 \times 1 \div 6$	9. Package Volume = $6 + [(3 \div 7) \times 6]$

Note: A gravimetric procedure can be used if the weights of the labeled volume for the first two containers do not differ from each other by more than one division on the scale (if they meet this criterion, check the rest of the sample gravimetrically and record in Column 8). The weight of a given volume of paint often varies considerably from container to container; therefore, volumetric measurement may prove necessary for the entire sample using the headspace procedure in Step 8. To determine the volume and enter the Package Volume in Column 9. Proceed to procedures in Section 2.3.7. “Evaluate for Compliance”.

Note: To conserve inspection time and reduce destructive testing the inspector may stop testing and consider this test as an audit if the first few containers contain the correct. However, the inspector may continue to test the complete sample to determine the average fill level of the entire sample.

13. Use Section 2.3.6. “Determine Nominal Gross Weight and Package Error” to determine the “Nominal Gross Weight” as follows:

The nominal gross weight equals the sum of the average weight of the labeled volume (average of values recorded in Column 8) plus the average tare (average of values recorded in Column 3) for the containers selected for tare.

3.7.3. Evaluation of Results

Follow the procedures in Section 2.3.7. “Evaluate for Compliance” to determine lot conformance. (Amended 2019)

3.8. Testing Viscous Materials – Such As Caulking Compounds and Pastes

Use the following procedure for any package of viscous material labeled by volume. It is suitable for very viscous materials such as cartridge-packed caulking compounds, glues, pastes, and other similar products. It is best to conduct this procedure in a laboratory using a hood to ventilate solvent fumes. If used in the field, perform the test in a well-ventilated area. Except for the special measurement procedures to determine the weight of the labeled volume, this procedure follows the basic test procedure.

3.8.1. Test Equipment

- A scale that meets the requirements in Section 2.2. “Measurement Standards and Test Equipment.”

- Pycnometer (pik·näm´ətər), a vessel of known volume used for weighing semifluids. The pycnometer can be bought or made. If it is made, refer to it as a “density cup.” To make a 150 mL or 5 fl oz density cup, cut off the lip of a 150 mL beaker with an abrasive saw and grind the lip flat on a lap wheel. The slicker plate is available commercially. The metrology laboratory should calibrate the density cup gravimetrically with respect to the contained volume using the procedure as defined by the latest version of ASTM E542, “Standard Practice for Calibration of Laboratory Volumetric Apparatus.”

Note: If applicable, comply with any special instructions furnished by the manufacturer to calibrate a pycnometer that has not been calibrated. It is not necessary to reweigh or recalibrate for each test; however, mark the pieces of each unit to prevent interchange of cups and slicker plates.

- Appropriate solvents (water, Stoddard solvent, kerosene, alcohol, etc.)
- Caulking gun (for cartridge packed products)

3.8.2. Test Procedure

1. Follow the procedures in Section 2.3.1. “Define the Inspection Lot.” Use a “Category A” sampling plan in the inspection; and select a random sample.
2. Weigh a calibrated pycnometer and slicker plate and record as “pycnometer weight” and record the volume of the pycnometer.
3. Determine the gross weight of the first package and record the weight value. Open the package and transfer the product to the pycnometer by filling it to excess. Use a caulking gun to transfer product from the caulking cartridges. If using a pycnometer, cover it with a lid and screw the cap down tightly. Excess material will be forced out through the hole in the lid, so the lid must be clean. If using a density cup, place the slicker plate over $\frac{3}{4}$ of the cup mouth, press down and slowly move the plate across the remainder of the opening. With the slicker plate in place, clean all the exterior surfaces with solvent and dry.
4. Completely remove the product from the package container; clean the package container with solvent; dry and weigh it to determine the tare weight.
5. Weigh the filled pycnometer or filled density cup with slicker plate and record this weight. Subtract the weight of the empty pycnometer from the filled weight to determine the net weight of the product contained in the pycnometer and record this weight.
6. Clean the pycnometer and repeat Steps 3, 4, and 5 for the second package in the tare sample.
7. Determine acceptability of the density variation on the two packages selected for tare. If the difference between the densities of the two packages exceeds one division of the scale, do not use the gravimetric procedure to determine the net quantity of contents. Instead, use the procedure in steps 9, 10, and 11.

$$\text{Weight of Product in Pycnometer} \div \text{Pycnometer Volume} = \text{Product Density}$$

Note: If the gravimetric procedure can be used, perform Steps 8, 10, and 11 for each package in the sample.

8. Calculate the weight of product corresponding to the labeled volume of product according to the following formula:

$$\text{Product Density} \times \text{Labeled Volume} = \text{Labeled Weight}$$

9. Test each package individually by determining the product density in each package using the pycnometer and record the gross, tare, and net weight of each package. Subtract the weight of the labeled volume (determined for each package) from the net weight of product to arrive at each individual package error in units of weight.
10. Convert the package errors to units of volume using the following formula:

$$\text{Package Error (volume)} = (\text{Package Error [weight]} \times \text{Pycnometer Volume}) \div (\text{Weight of Product in Pycnometer})$$

11. Record the package errors on the report form, using an appropriate unit of measure.

3.8.3. Evaluation of Results

Follow the procedures in Section 2.3.7. “Evaluate for Compliance” to determine lot conformance.

3.9. Peat Moss

3.9.1. Dimensional Test Procedure for Compressed Quantity

(Added 2015)

3.9.1.1. Test Equipment

- Calculator or spreadsheet Software (programmed to make volume calculations)
- Worksheet for Peat Moss Labeled by Volume – Dimensional Procedure (see Appendix C. “Model Inspection Report Forms.”)
- Non-permanent marking pen.
- Knife or razor cutter (for use in opening packages and unwrapping shrink-wrapped pallets in warehouses)
- Cellophane or duct tape (for use in securing packaging tails)
- Dimensional Measuring Frame (see Figure 3-1. “Dimensional Measuring Frame”).



Figure 3-1. Dimensional Measuring Frame

- Rigid Rulers – Starrett or equal with 1.0 mm graduations. The edges of a ruler used with a measuring frame must be straight and the edges must be the zero point (see Figure 3-1. “Dimensional Measuring Frame”).
 - 304 mm (12 in)
 - 500 mm (19.5 in)
 - 1 m (39 in)
- Carpenter square
 - 304 mm (12 in)
 - 600 mm (24 in)

(Amended 2015)

3.9.1.2. Test Procedure

Test Notes:

Rounding: When a package measurement falls between graduations on a ruler, round the value up. This practice eliminates the issue of rounding from the volume determination and provides the packager the benefit of the doubt. If a ruler with a graduation of 1.0 mm is used, the rounding error will be limited to 0.5 mm or less. It is good practice to circle a measurement that has been rounded up or make a statement to such effect so that it becomes a part of the record.

Dimension Identification: The following package nomenclature is used to identify the dimensions measured in this test procedure (see Figure 3-2. “Dimensional Identification”).

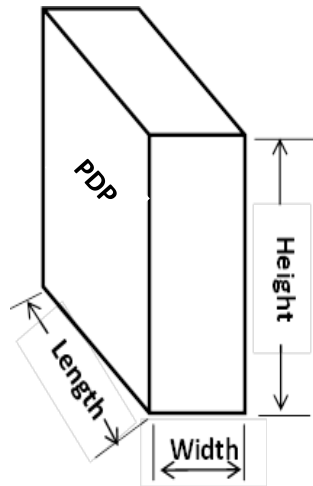


Figure 3-2. Dimensional Identification

Note: Packages of compressed peat moss do not have declaration of expanded volume.

Safety Precautions:

This procedure does not address all of the safety issues that users need to be aware of in order to carry out the following tasks. Users are sometimes required to conduct tests in warehouse spaces or retail stores where forklift trucks are in motion – care must be taken to warn others to avoid or exercise care around the test site. The procedure requires users to lift heavy objects including large bulky packages and test measures and includes the use of sharp instruments to obtain packages from shrink-wrapped pallets. Users may be required to climb ladders or work platforms to obtain sample packages. When opening and emptying packages, dust, or other particles may be present or escape from the packages, which may cause eye injuries and respiratory or other health problems. Users must utilize appropriate safety equipment and exercise good safety practices. If safe working conditions cannot be ensured, suspend testing until the situation is corrected.

1. Follow Section 2.3.1. “Define the Inspection Lot.” Use a “Category A” Sampling Plan for the inspection. Collect the sample packages from the Inspection Lot using random sampling. If the packages are not randomly selected, the sample will not be representative of the lot and the test results will not be valid for use in enforcement action. Place the sample packages in a location where there is adequate lighting and ample space for the packages and test equipment.
2. Examine the package for excess packaging material (i.e., packaging tails). Fold the packaging material consistent with design of the packaging and tape the material securely to the package so that its effect on the dimensional measurement is minimized. If the thickness of packaging tail appears excessive, it is appropriate to determine its average thickness by making at least three measurements along its length using a dead weight dial micrometer specified in Section 4.5. “Polyethylene Sheeting” and subtract the thickness from the measurement of length, width or height. Any deduction from a measurement should be noted on the inspection report.
3. If a Dimensional Measuring Frame is used, place it on a solid support. If a table is used, select one of sufficient load capacity to hold the weight of the frame and the heaviest package to be tested.

4. Position the frame so that the zero end of the ruler can be placed squarely and firmly against a surface of the frame and so that the ruler graduations can be read. Position yourself so that you can read both the ruler and the edge of the carpenter square in Figure 3-3. “Rigid Frame.”



Figure 3-3. Rigid Frame. The rigid frame allows the observer to hold the zero reference point firmly in place.

5. Place the package against two sides of the frame without compressing the package. Place a carpenter square against the package at the point of measurement and align the ruler perpendicular to the edge of the carpenter square as shown in Figure 3-4. “Length Measurement” where the package length and Figure 3-5. “Height Measurement” where the package height are being determined.



Figure 3-4. Length Measurement.

Using a Measuring Frame for Dimensional Testing Ruler and Carpenter Square Define Zero Reference and Measurement Point.

6. Measurements – take at least five measurements* of each of the dimensions as follows:

*On small packages (height or length dimensions of 152 mm [6 in] or less), at least three measurements are taken using the following instructions.

Inspect the package for shape and place the flattest surfaces against the measuring frame.	
<p>Length (see Figure 3-4. “Length Measurement”)</p> <ol style="list-style-type: none"> (a) Take the first measurement across the center line of the length axis of package. (b) Take the second measurement at half the distance between the center line and either of the package edges. (c) Take the third measurement half the distance between the second measurement and the package edge. (d) Take the fourth measurement on the opposite end of the package at half of the distance between the center line and the package edge. (e) Take the fifth measurement at half of the distance between the fourth measurement and the package edge. 	
<p>Height (see Figure 3-5. “Height Measurement”):</p> <ol style="list-style-type: none"> (a) Take the first measurement across the center line of the height axis of the package. (b) Take the second measurement at half the distance between the center line and the package edge. (c) Take the third measurement half the distance between the second measurement and the package edge. (d) Take the fourth measurement on the opposite end of the package at half of the distance between the center line and the package edge. (e) Take the fifth measurement at half of the distance between the fourth measurement and the package edge. 	
<p>Width (see Figure 3-6. “Width Measurement”): If using one, turn the measuring frame on end and place the package on its bottom and against the frame as shown in the picture and on the right where the package width is being measured.</p> <ol style="list-style-type: none"> (a) Take the first measurement across the center line of width axis of the package. (b) Take the second measurement at half the distance between the center line and the package edge. (c) Take the third measurement half the distance between the second measurement and the package edge. (d) Take the fourth measurement on the opposite end of the package at half the distance between the center line and the package edge. (e) Take the fifth measurement half of the distance between the fourth measurement and the package edge. 	



Figure 3-5. Height Measurement. The packaging tail on the end of the package can affect this measurement so it has been folded over and taped against the end of the package.



Figure 3-6. Width Measurement. The frame is rotated on its end to vertical so that the carpenter square does not compress the product.

- Record the dimensions of each package in millimeters in a software program or inspection form that includes the information shown in the sample worksheet “Calculate the Compressed Volume of the Package in Liters” (below). Enter the measurements in the appropriate spaces and calculate the volume in liters. Calculate the package error by following the steps listed in the table and then calculate the average error for the sample.

Note: The following table is an example of the information from an actual test that is included in a worksheet for verifying the compressed volume on packages of peat moss. The Peat Moss Labeled by Volume Package Worksheet – Dimensional Procedure (see Appendix C. Model Inspection Forms) has space for a sample of 12 packages and includes the steps for calculating the Average Package Error. Here, the package error in the dimensional volume was + 6.8 L (+ 0.24 ft³). To determine the value of the MAV, look up the labeled quantity in Appendix A., Table 2-6. “Maximum Allowable Variations for Packages Labeled by Liquid and Dry Volume.”

Sample Worksheet				
Calculate the Compressed Volume of the Package in Liters				
Unit of Measure = 1.0 mm		Length (L)	Width (W)	Height (H)
1.		482	282	690
2.		490	278	690
3.	(Center Line)	493	276	681
4.		499	272	677
5.		493	269	657
a.	Average:	491	275.4	679
b.	$L \times W \times H = \text{Volume}/1\ 000\ 000$	91.8L		
c.	Labeled Compressed Quantities:	85.0 L	NA cu in	3.0 cu ft

Sample Worksheet				
Calculate the Compressed Volume of the Package in Liters				
Unit of Measure = 1.0 mm		Length (L)	Width (W)	Height (H)
d.	Conversion Factors	<i>NA</i>	$(b) \times 61.02374$	$(b) \times 0.03531467$
e.	Converted Volume	<i>85.0 L</i>	<i>NA cu in</i>	<i>3.24 cu ft</i>
f.	Package Error = (b – c)	<i>6.8 L</i>	<i>NA cu in</i>	<i>0.24 cu ft</i>

(Amended 2010 and 2015)

3.9.2. Uncompressed Volume Packages

Use the following method to test peat moss sold using an uncompressed volume as the declaration of content. The procedure as defined by the latest version of ASTM D2978, “Standard Test Method for Volume of Processed Peat Materials.”

3.9.2.1. Test Equipment

- 12.7 mm (or 1/2 in) sieve
- Use a measure appropriate for the package size. (Refer to Table 3-4. “Specifications for Test Measures for Mulch and Soils” for additional information on test measure size and construction.)
- Straight edge, 508 mm (20 in) in length
- Sheet for catching overflow of material
- Level (at least 152 mm [6 in] in length)

(Amended 2015)

3.9.2.2. Test Procedure

1. Follow Section 2.3.1. “Define the Inspection Lot.” Use a “Category A” sampling plan in the inspection; select a random sample.
2. Open each package and pour the contents from a height of 2 ft through the sieve directly into the measuring container (overfilling it). Use this method for particulate solids (such as soils or other garden materials) labeled in cubic dimensions or dry volume. Some materials may not pass through the sieve for peat moss; in these instances, separate the materials by hand (to compensate for packing and settling of the product after packaging) before filling the measure.

Note: Separated material (product not passing through the sieve) must be included in the product volume.

3. Shake the measuring container with a rotary motion at one rotation per second for five seconds. Do not lift the measuring container when rotating it. If the package contents are greater than the measuring container capacity, level the measuring container contents with a straightedge using a zigzag motion across the top of the container.

4. Empty the container. Repeat the filling operations as many times as necessary, noting the partial fill of the container for the last quantity delivered using the interior horizontal markings as a guide.
5. Record the total volume.
6. To compute each package error, subtract the labeled quantity from the total volume and record it.

(Amended 2015)

3.9.3. Evaluation of Results

Follow the procedures in Section 2.3.7. “Evaluate for Compliance” to determine lot conformance for either procedure.

(Amended 2015)

3.10. Mulch and Soils Labeled by Volume

Mulch is defined as “any product or material except peat or peat moss that is advertised, offered for sale, or sold for primary use as a horticultural, above-ground dressing, for decoration, moisture control, weed control, erosion control, temperature control, or other similar purposes.”

Soil is defined as “any product or material, except peat or peat moss that is advertised or offered for sale, or sold for primary use as a horticultural growing media, soil amendment, and/or soil replacement.”

3.10.1. Test Equipment

- A test measure appropriate for the package size that meets the specifications for test measures in Table 3-4. “Specifications for Test Measures for Mulch and Soils”
- Drop cloth/polyethylene sheeting for catching overflow of material
- Level (at least 152 mm [6 in] in length)

Table 3-4.
Specifications for Test Measures for Mulch and Soils

Nominal Capacity of Test Measure ⁴	Actual Volume of the Measure ⁴	Interior Length ¹	Interior Width ¹	Interior Height ²	Marked Intervals on Interior Wall ³	Volume Equivalent of Marked Intervals
30.2 L (1.07 cu ft) for testing packages that contain less than 28.3 L (1 cu ft or 25.7 dry qt)	31.9 L (1.13 cu ft)	213.4 mm (8.4 in)	203.2 mm (8 in)	736.6 mm (29 in)	12.7 mm (1/2 in)	550.6 mL (33.6 in ³)
28.3 L (1 cu ft)	33.04 L (1.16 cu ft)	304.8 mm (12 in)	304.8 mm (12 in)	355.6 mm (14 in)	12.7 mm (1/2 in)	1179.8 mL (72 cu in)
		406.4 mm (16 in)	228.6 mm (9 in)			
56.6 L (2 cu ft)	63.7 L (2.25 cu ft)	304.8 mm (12 in)	304.8 mm (12 in)	685.8 mm (27 in)		
		406.4 mm (16 in)	228.6 mm (9 in)	685.8 mm (27 in)		
84.9 L (3 cu ft)	92 L (3.25 cu ft)	304.8 mm (12 in)	304.8 mm (12 in)	990.6 mm (39 in)		
		406.4 mm (16 in)	228.6 mm (9 in)	990.6 mm (39 in)		

Measures are typically constructed of 1.27 cm (1/2 in) marine plywood. The measure must accommodate the entire contents of the package being tested, and a transparent sidewall is useful for determining the level of fill, but must be reinforced if it is not thick enough to resist distortion. If the measure has a clear front, place the level gage at the back (inside) of the measure so that the markings are read over the top of the mulch.

Notes

¹Other interior dimensions are acceptable if the test measure approximates the configuration of the package under test, can accommodate the entire contents of the package at one time and does not exceed a base configuration of the package cross-section.

²The height of the test measure shall be 355.6 mm (14 in) for a 1 cu ft package, 685.8 mm (27 in) for a 1.5 cu ft to 2 cu ft package or 990.6 mm (39 in) for a 3 cu ft package.

³When lines are marked in boxes, they should extend to all four sides of the measure, if possible to improve readability. It is recommended that a line indicating the MAV level also be marked to reduce the possibility of reading errors when the level of the mulch is at or near the MAV.

⁴The Nominal Capacity is given to identify the size of packages that can be tested in a single measurement using the dry measure with the listed dimensions. It is based on the most common package sizes of mulch in the marketplace. If the measures are built to the dimensions shown above the actual volume will be larger than the nominal volume so that plus errors (overfill) can be measured accurately.

(Amended 2010 and 2017)

This publication is available free of charge from: <https://doi.org/10.6028/NIST.HB.133-2023>

3.10.2. Test Procedure

1. Follow Section 2.3.1. “Define the Inspection Lot.” Use a “Category A” sampling plan in the inspection, and select a random sample.
2. Some types of mulch are susceptible to clumping and compacting. To ensure that the material is loose and free flowing when placed into the test measure, gently massage the package while rolling the bag on the ground (or flat surface) at least four full rotations (but not more than eight full rotations), without lifting or dropping the package, before opening to reduce the clumping and compaction of the material.

Note: Mulch products stored exposed to the elements may become saturated with moisture. Excessive moisture adds weight to mulch particles and distorts the volume test results. Test samples with flowing or excessive collected moisture in the package shall be excluded from the test procedure.

3. Placing contents into the test measure.
 - Open the bag, gather the bag opening to ensure that no product is lost. Place the gathered bag opening as far into the top of the measure as possible without disturbing or leaning against the measure.
 - Release the bag opening and quickly dump the contents of the package into a test measure in a continuous flow.

Note: Do not touch the product or disturb the test measure by rocking, shaking, dropping or tamping it during the test procedure.

- Massage the outside of the bag to maintain a continuous flow of the product but not for the purpose of de-clumping the product.
 - Using your hand, gently level the contents, being careful not to affect the compaction of the product.
4. Read the horizontal marks at a position level with the product and round the readings between two marked intervals up to the nearest 38.1 mm (1/2 in) increment to determine the package net volume.
 5. Determine package errors by subtracting the labeled volume from the package net volume in the measure. Record each package error.

$$\text{Package Error} = \text{Package Net Volume} - \text{Labeled Volume}$$

(Amended 2017)

3.10.3. Evaluation of Results

Follow the procedures in Section 2.3.7. “Evaluate for Compliance” to determine lot conformance.

Note: In accordance with Appendix A, Table 2-10. “Exceptions to the Maximum Allowable Variations for Textiles, Polyethylene Sheeting and Film, Mulch and Soil Labeled by Volume, Packaged Firewood and Stove Wood Labeled by Volume, and Packages Labeled by Count with 50 Items or Fewer, and

Specific Agricultural Seeds Labeled by Count”, apply an MAV of 5 % of the declared quantity to mulch and soil sold by volume. When testing mulch and soil with a net quantity in terms of volume, one package out of every 12 in the sample may exceed the 5 % MAV (e.g., one in a sample of 12 packages; two in a sample of 24 packages; four in a sample of 48 packages). However, the sample must meet the average requirement of the “Category A” Sampling Plan.

3.11. Ice Cream Novelties

Note: The following procedure can be used to test packaged products that are solid or semisolid and that will not dissolve in, mix with, absorb, or be absorbed by the fluid into which the product will be immersed. For example, ice cream labeled by volume can be tested using ice water or kerosene as the immersion fluid.

Exception: Pelletized ice cream is beads of ice cream which are quick frozen with liquid nitrogen. The beads are relatively small, but can vary in shape and size. On April 17, 2009, the FDA issued a letter stating that this product is considered semisolid food, in accordance with 21 CFR 101.105(a). The FDA also addresses that the appropriate net quantity of content declaration for pelletized ice cream products be in terms of net weight.

(Added 2010)

The following volume displacement procedure uses a displacement vessel specifically designed for ice cream novelties such as ice cream bars, ice cream sandwiches, or cones. The procedure determines the volume of the novelty by measuring the amount of water displaced when the novelty is submerged in the vessel. Two displacements per sample are required to subtract the volume of sticks or cups.

The procedure first determines if the densities of the novelties are the same from package to package (in the same lot) so that a gravimetric test can be used to verify the labeled volume. If a gravimetric procedure is used, compute an average weight for the declared volume from the first two packages and weigh the remainder of the sample. If the gravimetric procedure cannot be used, use the volume displacement procedure for all of the packages in the sample.

3.11.1. Test Equipment

- A scale that meets the requirements in Section 2.2. “Measurement Standards and Test Equipment”
- Volumetric measures
- Displacement vessel with dimensions appropriate for the size of novelties being tested (see Figure 3-7, “Example of a Displacement Vessel”). It should include an interior baffle that reduces wave action when the novelty is inserted and a downward angled overflow spout to reduce dripping. Other designs may be used.

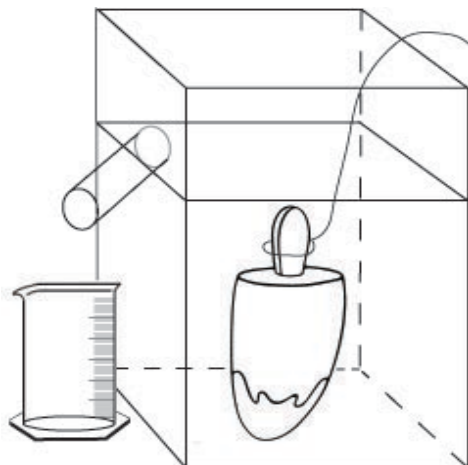


Figure 3-7. Example of a Displacement Vessel.

- Thin wire, clamp, or tongs
- Freezer or ice chest and dry ice
- Single-edged razor or sharp knife (for sandwiches only)
- Ice water/kerosene maintained at 1 °C (33 °F) or below
- Indelible marker (for ice pops only)
- Level, at least 152 mm (6 in) in length
- Partial immersion thermometer or equivalent with 1 °C (2 °F) graduations and a – 35 °C to + 50 °C (– 30 °F to + 120 °F) accurate to ± 1 °C (± 2 °F)
- A table top, laboratory-type jack of sufficient size to hold the displacement vessel
- Stopwatch

3.11.2. Test Procedure

1. Follow the procedures in Section 2.3.1. “Define the Inspection Lot.” Use a “Category A” sampling plan in the inspection; and select a random sample.
2. Maintain the samples at the reference temperature for frozen products that is specified in Table 3-1. “Reference Temperatures for Liquids.” Place the samples in the freezer or ice chest until they are ready to be tested, and then remove packages from the freezer one at a time.
3. According to the type of novelty, prepare the sample products as follows:
 - ***Ice-pop.** Mark on the stick(s) with the indelible marker the point to which the ice-pop will be submerged in the ice water. (After the ice-pop contents have been submerged, remove the novelty to determine the volume of the stick.)

- ***Cone.** Make a small hole in the cone below the ice cream portion to allow air to escape.
 - **Sandwich.** Determine whether the declared volume is (a) the total volume of the novelty (that is, including the cookie portion) or (b) the volume of the ice-cream-like portion only. If the declared volume is the volume of only the ice-cream-like portion, shave off the cookie with a razor or knife, leaving some remnants of cookie to ensure that no ice cream is accidentally shaved off. Work quickly, and return the novelty to the freezer before the sandwich softens.
 - **Cup.** Remove the cap from the cup.
4. Fill the displacement vessel with ice water until it overflows the spout. Allow it to sit until dripping stops. Raise the displacement vessel as necessary and place the graduate beneath the spout.
 5. Remove a package from the freezer, determine its gross weight, and record it.
 6. Submerge the novelty as suggested until it is below the surface level of the water.
 - **Ice-pop.** Use a clamp, tongs, or your fingers to hold the stick(s) and submerge the ice-pop to the level marked in Step 3 of the Test Procedure.
 - **Cone.** Shape the wire into a loop, and use it to push the cone, headfirst (ice cream portion first) into the ice water. Do not completely submerge the cone immediately: let water fill the cone through the hole made in Step 3 of the Test Procedure before completely submerging the novelty.
 - **Sandwich or cup.** Skewer the novelty with the thin wire or form a loop on the end of the wire to push the sandwich or ice cream portion or cup completely below the liquid level.
 7. Record the total water volume in the graduate.
 - For a cone or sandwich, record the water volume as the net volume and go to Step 9.
 - For ice-pops or cups, record the water volume in the graduate as the gross volume and go to Step 8.
 8. Refill the displacement vessel with water to overflowing and reposition the empty graduate under the spout. After the cup and novelty contents have been submerged, remove the novelty from the cup to determine the volume of the cup.
 - **Ice-pop.** Melt the ice-pop off the stick or sticks. Submerge the stick or sticks to the line marked in Step 3. Record the volume of tare material (i.e., stick) by measuring the water displaced into the graduate. The net volume for the ice-pop is the gross volume recorded in Step 7 minus the volume of the tare materials in this step. Record this volume as the “volume of novelty.” To determine the error in the package, subtract the labeled quantity from the volume of novelty.
 - **Cup.** Remove the novelty from the cup. Rinse the cup, and then submerge it in the displacement vessel. Small pinholes in the base of the cup can be made to make submersion easier. Record the volume of water displaced into the graduate by the cup as

the volume of tare material. The net volume for the novelty is the gross volume determined in Step 7 minus the volume of the tare materials determined in this step. Record this as the net volume of the novelty. To determine the error in the package, subtract the labeled quantity from the volume of novelty.

9. Clean and air-dry the tare materials (sticks, wrappers, cup, lid, etc.). Weigh and record the weight of these materials for the package.
10. Subtract the tare weight from the gross weight to obtain the net weight and record this value.
11. Compute the weight of the labeled volume for the package using the following formula and then record the weight:

$$\text{Product Density} = (\text{product net weight in Step 10}) \div (\text{the total water volume in Step 7} - \text{volume of tare material in Step 8})$$

$$\text{Weight of labeled volume} = (\text{labeled volume}) \times (\text{Product Density})$$

12. Repeat Steps 3 through 11 for a second package.
13. If the weight of the labeled volumes in Step 11 for the two packages differs from each other by more than one division on the scale, the gravimetric test procedure cannot be used to test the sample for compliance. If this is the case, use Steps 3 through 8 for each of the remaining packages in the sample to determine their net volumes and package errors. Then go to evaluation of results. If the weights of the labeled volumes agree within one division, continue to Step 14 to test the rest of the sample using the gravimetric test procedure.*
14. Use Section 2.3.5.1. “Determination of Tare Sample and Average Tare Weight” to determine the Average Used Dry tare Weight of the sample.
15. Find the Average Product Density by adding the densities of the product from the two packages and dividing the sum by two.
16. Using the weight of labeled volume determined in Step 11, calculate the Average Product Weight by multiplying the weight of the labeled volume by the average product density.

$$\text{*Average Product Weight} = \text{Labeled Volume} \times \text{Average Product Density}$$

17. Calculate the “nominal gross weight” using the formula:

$$\text{Nominal Gross Weight} = \text{Average Product Weight} + \text{Average Used Dry Tare Weight}$$

18. Weigh the remaining packages in the sample.
19. Subtract the nominal gross weight from the gross weight of each package to obtain package errors in terms of weight.

Note: Compare the sample packages to the nominal gross weight.

20. Determine the average package error by totaling all package errors and dividing by the number of packages in the sample.

To convert the average error or package error from weight to volume, use the following formula:

$$\text{Package Error in Volume} = (\text{Package Error in Weight}) \div (\text{Average Product Density})$$

3.11.3. Evaluation of Results

Follow the procedures in Section 2.3.7. “Evaluate for Compliance” to determine lot conformance.

3.12. Fresh Oysters Labeled by Volume

Packaged fresh oysters removed from the shell must be labeled by volume. The maximum amount of permitted free liquid is limited to 15 % by weight. (see NIST Handbook 130, Method of Sale of Commodities, Section 1.5.2.3. “Fresh Oysters Removed From Shell.”) Testing the quantity of contents of fresh oysters requires the inspector to determine total volume, total weight of solids and liquid, and the weight of the free liquid.

3.12.1. Test Equipment

- A scale that meets the requirements in Section 2.2. “Measurement Standards and Test Equipment”
- Volumetric measures
- Micrometer depth gage (ends of rods fully rounded), 0 mm to 228 mm (0 in to 9 in)
- Strainer for determining the amount of drained liquid from shucked oysters. Use a strainer and a slightly smaller bottom receiving pan or tray constructed to the following specifications:
 - Sides: 50 mm (2 in)
 - Area: 1935 cm² (300 in²) or more for each 3.78 L (1 gal) of oysters

Note: Strainers of smaller area dimensions are permitted to facilitate testing smaller containers.

- Perforations:
 - Diameter: 6.35 mm (¹/₄ in)
 - Location: 3.17 cm (1¹/₄ in) apart in a square pattern, or perforations of equivalent area and distribution.
- Spanning bar, 25.4 mm × 25.4 mm × 304 mm (1 in × 1 in × 12 in)
- Rubber spatula
- Partial immersion thermometer, 1 °C (2 °F) graduations and a range of – 35 °C to + 50 °C (– 30 °F to + 120 °F) accurate to ±1 °C (± 2 °F)
- Level, at least 152 mm (6 in) in length

- Stopwatch

(Amended 2014)

3.12.2. Test Procedure

Note: Test the oysters at a temperature of 7 °C (± 1 °C) (45 °F [± 2 °F])

1. Follow Section 2.3.1. “Define the Inspection Lot.” Use a “Category A” sampling plan in the inspection; and select a random sample.
2. Determine and record the gross weight of a sample package.
3. Set the container on a level surface and open it. Use a depth gage to determine the level of fill. Lock the depth gage. Mark the location of the gage on the package.
4. Weigh a dry receiving pan and record the weight. Set strainer over the receiving pan.
5. Pour the contents from the container onto the strainer without shaking it. Drain for two minutes. Remove strainer with oysters. It is normal for oysters to include mucous (which is part of the product) that will not pass through the strainer, so do not force it.
6. Weigh the receiving pan and liquid and record the weight. Subtract the weight of the dry receiving pan from the weight of pan and liquid to obtain the weight of free liquid and record the value.
7. Clean, dry, and weigh the container and record the tare weight. Subtract the tare weight from the gross weight to obtain the total weight of the oysters and liquid and record this value.
8. Determine and record the percent of free liquid by weight as follows:

Note: This handbook provides a worksheet for Determining the Free Liquid and Net Volume of Oysters in Appendix C. “Model Inspection Report Forms.”

$$\text{Percent of free liquid by weight} = [(weight\ of\ free\ liquid) \div (weight\ of\ oysters + liquid)] \times 100$$

or

$$(f \div c) \times 100 = \text{Percentage of Free Liquid by Weights}$$

Where:

$$f = \text{Weight of Free Liquid}$$

$$c = (\text{Net Weight of Oysters} + \text{Liquid})$$

9. Set up the depth gage on the dry package container as in Step 3. Pour water from the flasks and graduate as needed to re-establish the level of fill obtained in Step 3. Add the volumes delivered as the actual net volume for the container and record the value.

Note: Some containers will hold the declared volume only when filled to the brim; they may have been designed for other products, rather than for oysters. If the net volume is short measure (per Step 9),

determine if the container will reach the declared volume only if filled to the brim. Under such circumstance, the package net volumes will all be short measure because the container cannot be filled to the brim with a solid and liquid mixture. A small headspace is required in order to get the lid into the container without losing any liquid.

(Amended 2014)

3.12.3. Evaluation of Results

Follow the procedures in Section 2.3.7. “Evaluate for Compliance” to determine lot conformance.

3.13. Determining the Net Contents of Compressed Gas in Cylinders

These procedures are for industrial compressed gas. Compressed gas may be labeled by weight (for example, Liquefied Petroleum [LP] gas, or carbon dioxide) or by volume. Acetylene, liquid oxygen, nitrogen, nitrous oxide, and argon are all filled by weight. Acetylene is sold by liters or by cubic feet. Helium, gaseous oxygen, nitrogen, air, and argon are filled according to pressure and temperature tables.

Checking the net contents of compressed gas cylinders depends on the method of labeling; those labeled by weight are generally checked by weight. Cylinders filled by using pressure and temperature charts must be tested using a pressure gage that is connected to the cylinder. The volume is determined using the pressure and temperature of the cylinder.

Safety Precautions:

Be aware of the hazards of the high pressure found in cylinders of compressed gas. An inspector should handle compressed gas only if the inspector has been trained and is knowledgeable regarding the product, cylinder, fittings, and proper procedures (see *Compressed Gas Association [CGA] pamphlet P-1, “Safe Handling of Compressed Gases in Containers,”* for additional information). Additional precautions that are necessary for personal safety are described in the CGA Handbook of Compressed Gases. All personnel testing compressed gases should have this manual for reference and be familiar with its contents. It is essential that the inspector be certain of the contents before connecting to the cylinder. Discharging a gas or cryogenic liquid through a system for which the material is not intended could result in a fire and/or explosion or property damage due to the incompatibility of the system and the product. Before connecting a cylinder to anything, be certain of the following:

1. Always wear safety glasses.
2. The cylinder is clearly marked or labeled with the correct name of the contents and that no conflicting marks or labels are present. Do not rely on the color of the cylinder to identify the contents of a cylinder. Be extremely careful with all gases because some react violently when mixed or when coming in contact with other substances. For example, oxygen reacts violently when it comes in contact with hydrocarbons.
3. The cylinder is provided with the correct Compressed Gas Association (CGA) connection(s) for the product. A proper connection will go together smoothly; so excessive force should not be used. Do not use an adapter to connect oxygen to non-oxygen cleaned equipment. When a cylinder valve is opened to measure the internal pressure, position the body away from the pressure gage blowout plug or in front of the gage if the gage has a solid cast front case. If the bourdon tube should rupture, do not be in a position to suffer serious injuries from gas pressure or fragments of metal.

Note: The acetone in acetylene cylinders is included in the tare weight of the cylinder. Therefore, as acetylene is withdrawn from the cylinder, some acetone will also be withdrawn, changing the tare weight.

4. Thoroughly know the procedure and place emphasis on safety precautions before attempting any tests. Do not use charts referred to in the procedure until the necessary training has been completed. When moving a cylinder, always place the protective cap on the cylinder. Do not leave spaces between cylinders when moving them. This can lead to a “domino” effect if one cylinder is pushed over.
5. Open all valves slowly. A failure of the gage or other ancillary equipment can result in injuries to nearby persons. Remember that high gas pressure can propel objects with great force. Gas ejected under pressure can also cause serious bodily injuries if someone is too close during release of pressure.
6. One of the gages will be reserved for testing oxygen only and will be prominently labeled “For Oxygen Use Only.” This gage must be cleaned for oxygen service and maintained in that “clean” condition. The other gage(s) may be used for testing a variety of gases if they are compatible with one another.
7. Observe special precautions with flammable gas in cylinders in addition to the several precautions necessary for the safe handling of any compressed gas in cylinders. Do not “crack” cylinder valves of flammable gas before connecting them to a regulator or test gage. This is extremely important for hydrogen or acetylene.

3.13.1. Test Equipment

- Scale that meets the requirements in Section 2.2. “Measurement Standards and Test Equipment.” Use a wooden or non-sparking metal ramp to roll the cylinders on the scale to reduce shock loading.
- Two calibrated precision bourdon tube gages or any other approved laboratory-type pressure-measuring device that can be accurately read within plus or minus 40 kPa (5 psi). A gage having scale increments of 200 kPa (25 psi) or smaller shall be considered as satisfactory for reading within plus or minus 40 kPa (5 psi). The range of both gages shall be a minimum of 0 kPa to 23 MPa (0 psi to 5000 psi) when testing cylinders using standard industrial cylinder valve connections. These standardized connections are listed in “*CGA Standard V-1, Standard for Compressed Gas Cylinder Valve Outlet and Inlet Connections for use with Gas Pressures up to 21 MPa (3000 psi)*.” For testing cylinders with cylinder valve connections rated for over 21 MPa (3000 psi), the test gage and its inlet connection must be rated at 14 MPa (2000 psi) over the maximum pressure that the connection is rated for in CGA V-1.

Notes:

- (1) There are standard high-pressure industrial connections on the market that are being used up to their maximum pressure of 52 MPa (7500 psi).
- (2) Any gage or connectors used with oxygen cylinders must be cleaned for oxygen service, transported in a manner which will keep them clean and never used for any other gas including air or oxygen mixtures. Oxygen will react with hydrocarbons and many foreign materials that may cause a fire or explosion.

- (3) Use a separate gage and fitting for each gas to be tested. If adapters must be used, do not use on oxygen systems.
 - An approved and calibrated electronic temperature measuring device or three calibrated liquid-in-glass thermometers having either a digital readout or scale division of no more than 1 °F (0.5 °C). The electronic device equipped with a surface temperature sensor is preferred over a liquid-in-glass thermometer because of its shorter response time.
 - Two box-end wrenches of 29 mm (1¹/₈ in) for oxygen, nitrogen, carbon dioxide, argon, helium, and hydrogen and 22 mm (⁷/₈ in) for some sizes of propane. All industrial CGA connections are limited to these two hex sizes. Avoid using an adjustable wrench because of the tendency to round the edges of the fittings, which can lead to connections not being tightened properly.

3.13.2. Test Procedures

a. Test Procedure for Cylinders Labeled by Weight

1. Follow Section 2.3.1. “Define the Inspection Lot.” Use a “Category A” sampling plan in the inspection; select a random sample.
2. The cylinder should be marked or stenciled with a tare weight. The marked value may or may not be used by the filling plant when determining the net weight of those cylinders sold or filled by weight. If there is a tare weight marked on the net contents tag or directly on the cylinder, then an actual tare weight was determined at the time of fill. If there is no tare weight marked on a tag or on the cylinder, then the stamped or stenciled tare weight is presumed to have been used to determine the net contents.

Note: Check the accuracy of the stamped tare weights on empty cylinders whenever possible. The actual tare weight must be within (a) $\frac{1}{2}$ % of the stamped tare weight for 9.07 kg (20 lb) tare weights or less or (b) $\frac{1}{4}$ % of the stamped tare weight for greater than 9.07 kg (20 lb) tare weights. (see NIST Handbook 130, Method of Sale Regulation, Section 2.16. “Compressed or Liquefied Gases in Refillable Cylinders.”) The cap is not included in the tare weight.

3. Place cylinder on scale and remove protective cap. Weigh the cylinder and determine net weight, using either the stamped or stenciled tare weight, or the tare weight marked on the tag. Compare actual net weight with labeled net weight, or use the actual net weight to look up the correct volume declaration (for Acetylene Gas), and compare that with the labeled volume.

Note: Most producers will replace acetone in the cylinder before the cylinder is refilled, filling the cylinder with acetone to the stamped tare weight. Other producers, although not following recommended procedures, do not replace the acetone until it drops to a predetermined weight. In the latter situation, the refilling plant must note the actual tare weight of the cylinder and show it on the tag containing the net content statement or on the cylinder itself. Refer to tables for acetylene if necessary (if the acetylene is labeled by volume).

b. Test Procedure for Cylinders Labeled by Volume

1. Follow Section 2.3.1. “Define the Inspection Lot.” Use a “Category A” sampling plan in the inspection; select a random sample.
2. Determine the temperature of the cylinders in the sample. Place the thermometer approximately halfway up a cylinder in contact with the outside surface. Take the temperature of three cylinders selected at random and use the average temperature of the three values.
3. Using the appropriate pressure gage, measure the pressure of each cylinder in the sample.
4. Determine the cylinder nominal capacity from cylinder data tables or from the manufacturer. (These tables must be obtained in advance of testing.)
5. The SCF/CF volume of compressed gases (e.g., oxygen, argon, nitrogen, helium, or hydrogen) shall be determined using NIST Standard Reference Database 23 “Reference Fluid Thermodynamic and Transport Properties Database” (REFPROP). (see www.nist.gov/srd/refprop) (**Note:** Weights and measures officials should contact the NIST Office of Weights and Measures at (301) 975-4004 or owm@nist.gov for access to the database.)
6. Multiply the cylinder nominal capacity by the value (SCF/CF) obtained from the content tables. This is the actual net quantity of gas.
7. Subtract the labeled net quantity from the actual net quantity to determine the error.

3.13.3. Evaluation of Results

Follow Section 2.3.7. “Evaluate for Compliance” to determine lot conformance.

3.14. Firewood – Volumetric Test Procedure for Packaged Firewood with a Labeled Volume of 113 L [4 ft³] or Less and Stacked Firewood Sold by the Cord or Fractions of a Cord.

Unless otherwise indicated, take all measurements without rearranging the wood or removing it from the package. However, if the layers of wood are crosshatched or not ranked in discrete sections in the package, remove the wood from the package, re-stack, and measure according to the procedures described in this section. For boxed firewood, it is the volume of the wood in the box that is determined not the volume of the box.

(Amended 2016)

3.14.1. Test Equipment

Linear Measurement		
The maximum value of graduations on a ruler or tape shall be equal to or less than:		
For Testing	SI Units	U.S. Customary Units
Packaged Firewood	1 mm	$\frac{1}{16}$ in (0.0625 in)
Stacked Firewood	0.5 cm	$\frac{1}{8}$ in (0.125 in)

Other Equipment:

Except where a long tape measure is needed for measuring stacks of wood and unless otherwise noted below, a precision tempered steel ruler should be used for linear measurements. Current calibration certificates issued by a NIST recognized or accredited laboratory should be available for all measuring devices.

- To test boxes of firewood, use a straightedge and a 150 mm (6 in) tempered steel pocket ruler to measure the box headspace. A rigid 610 mm (24 in) tempered steel ruler is required to measure piece length and the dimensions of the box.
- To test bundles of firewood, use a rigid 610 mm (24 in) tempered steel ruler to measure typical piece length. If the circumference based auditing method is to be conducted, a precision 610 mm (24 in) diameter (π) tape or flexible steel tape with 1 mm ($1/16$ in) graduations may be used to approximate the package volume for screening and audit purposes.

For testing stacks of firewood, a precision tape or long tape measure is used. For testing bundles and bags of firewood, the following equipment and materials are used in addition to the linear measures listed above:

- Binding Straps: Straps with ratchet type closures are easily tightened to secure the wood tightly. The binding straps are used to hold wood bundles together if the bundles need to be removed from the package/wrapping material.
- Graph Paper: 279.4 mm \times 431.8 mm (11 in \times 17 in) with 0.5 centimeter or $1/4$ inch squares. This paper is used for tracing and calculating the areas of the ends of a bundle of firewood. Prior to using any graph paper use a calibrated ruler to verify the dimensions of squares at several random points across the page.
- Ruler: 300 mm (12 in) with 0.5 cm ($1/4$ in) graduations. This ruler is used with the graph paper to calculate the area of the bundle ends.

(Amended 2016)

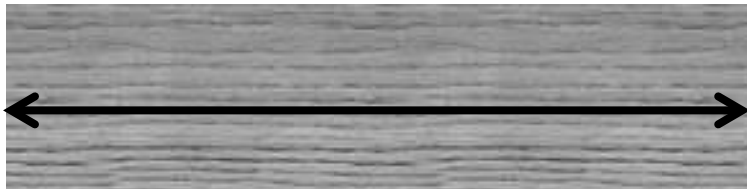
3.14.2. Test Procedure**General Instructions**

- When testing packaged firewood Section 2.3.1. “Define the Inspection Lot.” Use a “Category A” sampling plan in the inspection; and select a random sample.
- Measurements shall be read to the smallest graduation on the ruler or tape. Round any value that falls between two graduations up to the higher value except when making headspace depth measurements in the test procedure for boxes where a value falling between two graduations is rounded down.
- Samples for Length. Use Table 3-5. “Minimum Number of Pieces to be Measured for Length” to determine the minimum number of pieces to measure to determine the average length of the firewood pieces in a package or stack.

Table 3-5. Minimum Number of Pieces to be Measured for Length		
Volume		Minimum Number of Pieces to be Measured for Length*
1.	Packaged firewood 453 L (16 cu ft) ($\frac{1}{8}$ cord) or less	
a.	For packages with 12 pieces or less	All
b.	For packages with 13 to 50 pieces	At least 12 pieces
c.	For packages with more than 50 pieces	At least 24 pieces
2.	Stacked wood	At least 12 pieces for each $\frac{1}{2}$ cord or fraction thereof

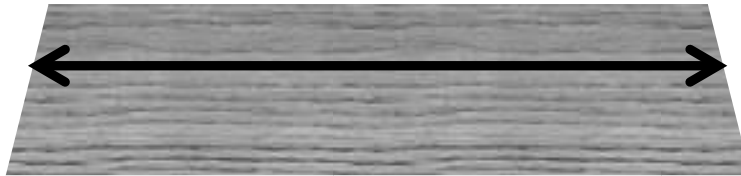
***Note:** While the packages of firewood to be included in the sample must be selected using the random sampling techniques described in NIST Handbook 133, Section 2.3.4. “Random Sample Selection,” those techniques are not used in selecting the individual pieces for measurement of length. Since the packages were selected at random, the assumption is made that the length of any piece selected for measuring is generally representative of the other pieces that the packer cut or selected for inclusion in the package under inspection. When selecting pieces of wood for measurement, take them from different locations in the package or stack so they are representative of the total amount of wood under test.

- Measuring Procedures for Length. – Use the instructions and graphics in Table 3-6. “Determining Piece Length” when measuring the length of the pieces to determine the average length of a piece of firewood based on its shape in a package or stack. If a piece of wood does not appear to fall within the examples shows, measure it as if it were an irregular shape and take three or more measurements and average them.

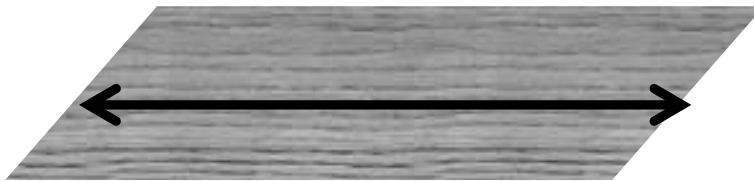
Table 3-6. Determining Piece Length	
(a) Uniform Shapes	
Errors in the length measurement can result in a significant volume errors especially with the small quantities typical of packaged wood. When the pieces are generally cut in a uniform manner, a single measurement along the center line of the longitudinal axis is used to determine piece length. Take the measurement along a straight line between two points over solid wood.	
(i) Most wood pieces are cut perpendicular to their longitudinal axis so one measurement taken from the face of one end to the face of the other end will provide an accurate length determination.	
	

**Table 3-6.
Determining Piece Length**

- (ii) On pieces of wood with “reverse bias” and “bias” end cuts estimate where the center line of the piece is and then measure to these points as shown below. The intent of this measurement is to determine an “average” length that is assumed to fall along the center line of the piece. The top piece is an example of a “reverse” bias cut.



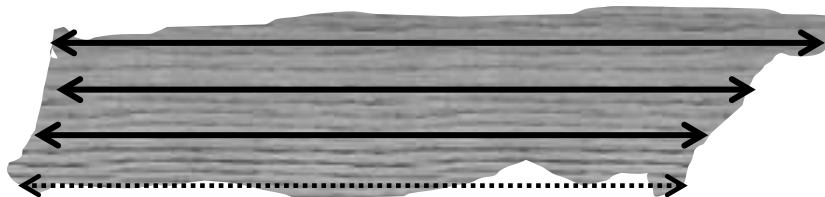
The bottom piece is an example of a bias cut



(b) Irregular Shapes

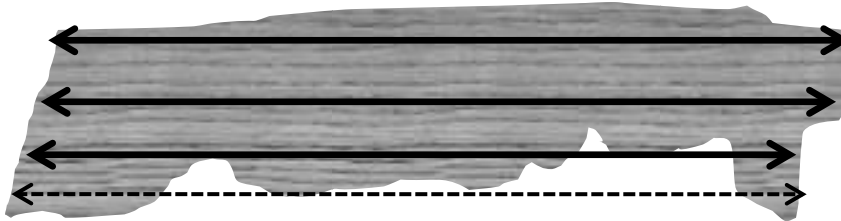
When the pieces have irregular shapes, cuts, or shattered ends, it is necessary to take at least three measurements and average the results to obtain the length of the piece. Take the measurements along a straight line between two points which cover solid wood that appear to be the shortest and longest dimensions and a third measurement at or near the center line of the piece.

- (iii) This piece has a bias cut end on the left and an irregular end on the right. The measurements are taken at the longest and shortest points where the line crosses over solid wood. The lowest measurement (dotted line over the air space) is not used because it does not cross wood. Only the three upper measurements are used to calculate the average length for this piece unless additional measurements across solid wood are taken.

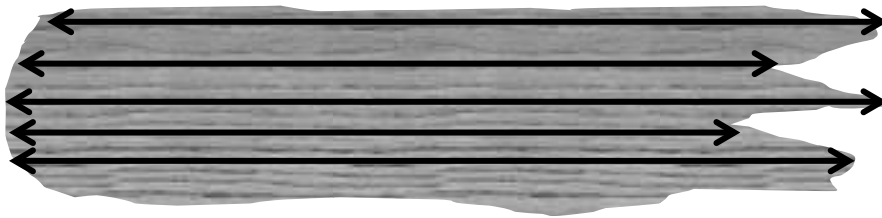


**Table 3-6.
Determining Piece Length**

- (iv) This is a piece with a bias cut on the left end and irregular end on the right. Note how the measurements are taken at the longest and shortest points where the line crosses over solid wood. The lowest measurement (the dotted line) would not be used because it does not crossover wood.



- (v) This piece of wood has a “shattered end.” Shattering occurs when wood is stressed beyond its breaking point and the end is not trimmed. The inspector will take additional measurements to account at the shortest point of the voids and longest points at the extensions. In this example, five measurements were taken and averaged to account for the voids and extensions.



a. Boxed Firewood

Note: A packer may place wrapped bundles of firewood in boxes for ease of handling as well as for display on retail store shelves. When a box contains a bundle of wrapped firewood, the volume of the bundle is verified using the test procedure in c. “Bundled and Bagged Firewood.”

1. Follow Section 2.3.1. “Define the Inspection Lot.” Use a “Category A” sampling plan in the inspection; and select a random sample.
2. Open the box to determine the average height of wood.
3. Measure the internal height of the box. (see Figure 3-8. “Measuring the Internal Height of the Box.”)

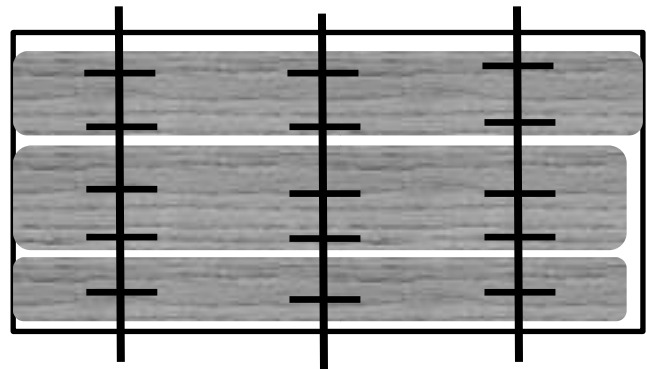


Figure 3-8. Measuring the Internal Height of the Box.

4. Determining the Height of the Wood. Take at least five measurements spaced at intervals along each end and center of the wood stack (record as “d₁, d₂ . .etc.”; taking at least 15 measurements). (see Figure 3-9. “Top View of the Box” – Measure at cross bars and Figure 3-9a. “Examples of the Headspace Measurement.”) Measure from the bottom of a straightedge placed across the top of the box to the highest point on the wood (round the measurements down to the nearest 0.5 cm [¹/₈ in] or less). Calculate the average height of the stack by averaging these measurements and subtracting the result from the internal height of the box using the following formula:

$$\text{Average Height of Wood Stack} = (\text{Internal Height of Box}) - (\text{Sum of Depth Measurements} \div \text{Number of Measurements})$$

Figure 3-9. Top View of the Box. Measure at the cross bars.



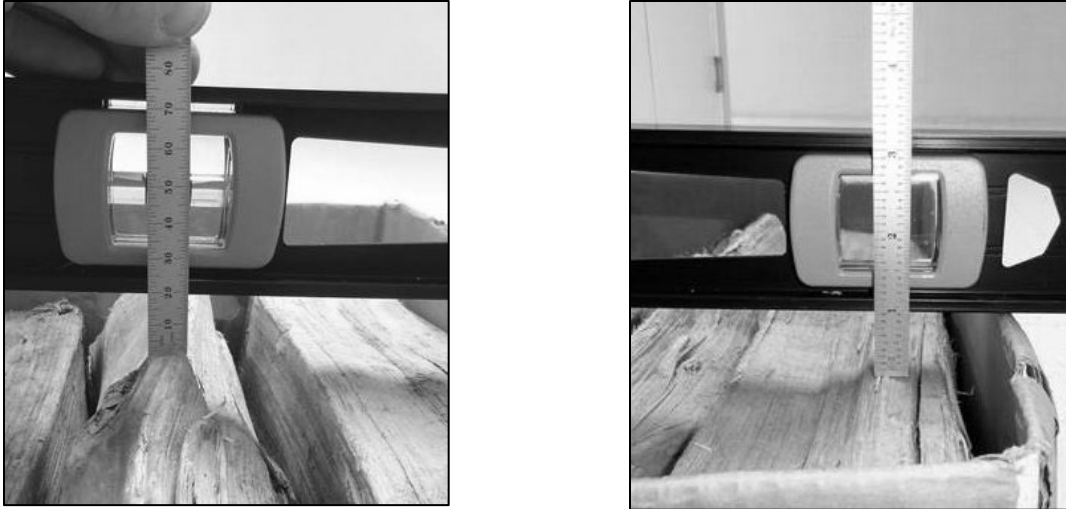


Figure 3-9a. Examples of the Headspace Measurement.

5. **Width of Wood Stack.** Open the box and measure the width of the wood stack. Take at least five measurements at intervals spaced along the length of the stack. Average these values to obtain an Average Width of Wood Stack. (see Figure 3-10. “Top View of the Box,” and Figure 3-10a. “Measuring the Width of the Firewood in a Box.”) You are measuring the width of the wood, not the width of the box.

$$\text{Average Width of Wood Stack} = (W1 + W2 + W3 + W4 + W5) \div 5$$

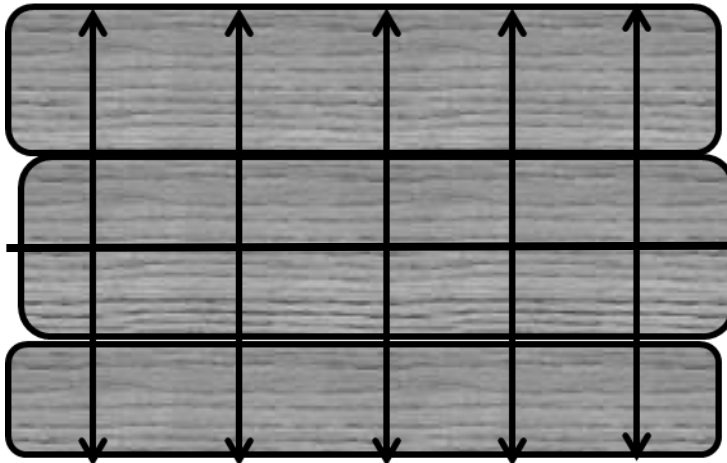


Figure 3-10. Top View of the Box. Measure at crosslines.

Figure 3-10a. Measuring the Width of the Firewood in a Box.



6. Individual Piece Length. Remove the wood from the package and measure the length of each piece of wood (see Table 3-5. “Minimum Number of Pieces to be Measured for Length”). If the piece of wood is uniform in shape, take at least one point-to-point measurement along the center line of the longitudinal axis (see Table 3-6. “Determining Piece Length, (a) Uniform Shapes” for examples) and record the value.

If the wood is irregularly shaped (see Table 3-6. “Determining Piece Length, (b) Irregular Shapes” for examples), take at least three measurements along a straight line between two points crossing solid wood that appear to be the shortest and longest dimensions, and a third at or near the center line of the piece. Calculate the average of the measurements to obtain the Average Individual Piece Length and record the length of the piece.

To determine Average Individual Piece Length (AIPL) of irregularly shaped pieces:

$$AIPL = (L_1 + L_2 + L_3) \div 3$$

After all pieces are measured, total the lengths and divide that total by the number of samples to obtain the Average Piece Length for the package.

To determine Average Piece Length (APL) for the package:

$$APL = (L_1 + L_2 + L_3 + L_n) \div (\text{Number of Pieces in Sample})$$

7. Use the average values for height, width, and length to calculate the volume of wood in the box.

$$\text{Volume in liters} = (\text{height in mm} \times \text{width in mm} \times \text{length in mm}) \div 1,000,000$$

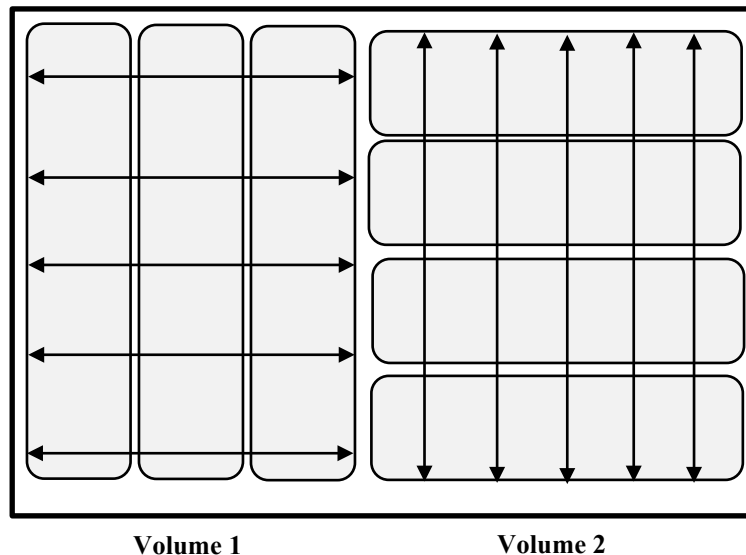
$$\text{Volume in cubic feet} = (\text{height in inches} \times \text{width in inches} \times \text{length in inches}) \div (1728)$$

Note: 1 cubic foot = 1728 in³, 1 cubic liter = 1,000,000 L³

8. For boxes of wood that are packed with the wood ranked in two discrete sections perpendicular to each other, calculate the volume of wood in the box as follows: (1) determine the average height, width, and length as in 1, 2, and 3 above for each discrete section, compute total volume, and (2) total the calculated volumes of the two sections. Compute total volume by adding Volume 1 (V_1) and Volume 2 (V_2) according to the following formula.

$$\text{Total Volume} = V_1 + V_2$$

This illustration shows how the width of the firewood is measured when two perpendicular stacks of firewood are in a box. The height, width, and length of the pieces are used to determine the volume of the separate stacks which are then added together to obtain the volume of wood in the package.



b. Stacked Firewood

Bulk deliveries of firewood are typically required by law or regulation to be on the basis of cord measurements. The “cord” is defined as the amount of wood contained in a space of 128 ft³ when the wood is ranked and well stowed. The standard dimensions for a cord of wood are 4 ft (height) × 4 ft (width) × 8 ft (length) but wood may be stacked and measured in any configuration. See Figure 3-11. “A Cord of Wood” for an illustration of how a cord may be stacked.

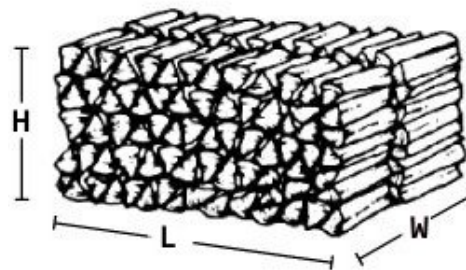


Figure 3-11. A Cord of Wood.
A cord of wood measures Length (8 ft) × Width (4 ft) × Height (4 ft).

1. Wood Delivered to a Consumer. If a delivery ticket or sales receipt is available (these are often required by state regulation), review the delivery ticket or sales receipt and determine the quantity

delivered. Identify the wood to be measured and verify the wood delivered was not mixed with wood that was already present at the location. Also, determine if the delivery was partial or complete (i.e., no additional deliveries are expected) and if any of the delivered wood has been used.

If necessary, stack the firewood in a ranked and well-stowed geometrical shape that facilitates volume calculations (i.e., rectangular). Any voids that will accommodate a piece of wood in the stack shall be deducted from the measured volume.

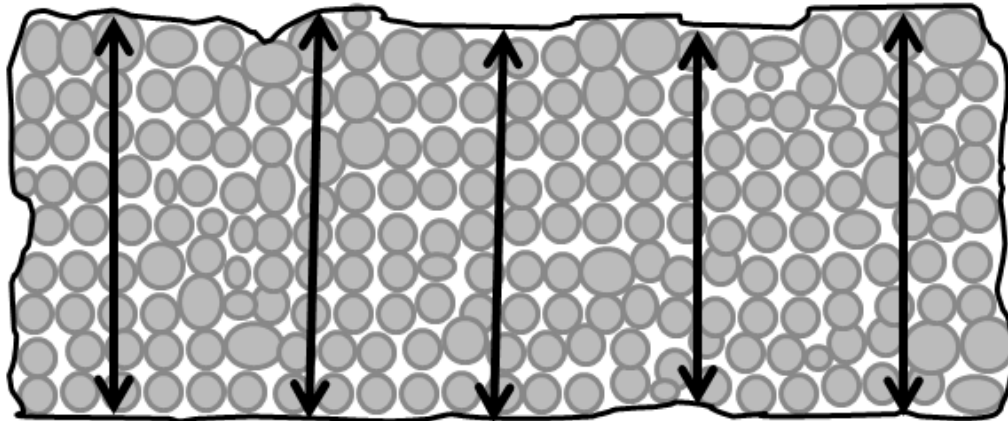
Note: The length measurements of the individual pieces may be made during the stacking process.

2. Determine the Average Measurements of the Stack. The number of measurements for each dimension given below is the minimum that should be taken.
 - **Height of Stack.** A height measurement is the vertical distance between the top edge of a piece of wood in the top row and the bottom edge of a piece of wood on the bottom row. Start at one end of the front of the stack; measure the height of the stack at five equally spaced intervals (e.g., approximately 18 in to 24 in) along the length of stack. If the length of the stack is over 10 ft, take additional height measurements at equally spaced intervals along its length. If the height of the stack varies significantly (e.g., the pieces are stacked in peaks along the length of the stack), take additional height measurements. Calculate and record the average height for the front of the stack. Repeat the same height measurement procedure along the back of the stack and then calculate and record the average height for the back of the stack. Calculate the average height of the stack by averaging the two results. If the wood to be measured is stacked on a slope, take the height measurements at right-angles to the slope.

$$\text{Average Height}_{\text{Front}} = (h_1 + h_2 + h_3 + h_4 + h_5) \div 5$$

$$\text{Average Height}_{\text{Back}} = (h_1 + h_2 + h_3 + h_4 + h_5) \div 5$$

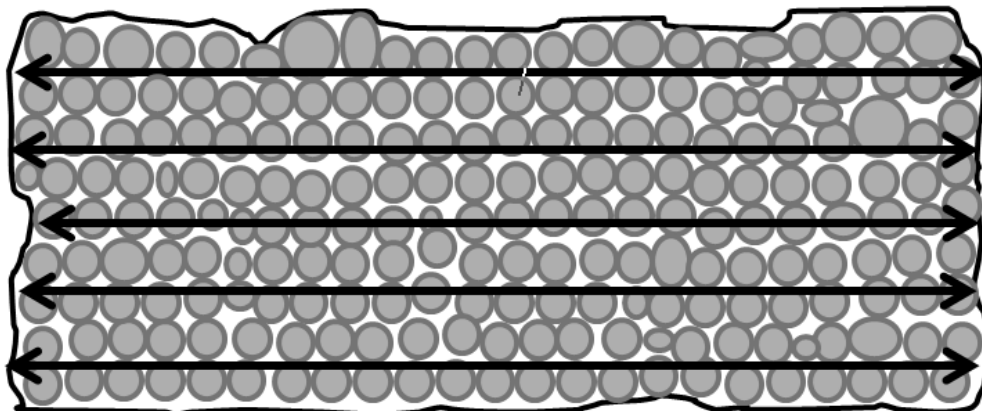
$$\text{Average Height of Stack} = \text{Average Height}_{\text{Front}} + \text{Average Height}_{\text{Back}} \div 2$$



Average Height Measurement (front and back)

- **Length of Stack.** A length measurement is the horizontal distance between the left edge of a piece of wood on the left side of the stack and the right edge of a piece of wood on the opposite side of the stack. Start at either side of the stack; measure the length of the stack in five equal intervals. Calculate and record the average length. If the length of the stack varies significantly

(e.g., the ends of the stack bulge out along the height of the stack), take additional measurements.



Average Length Measurement (front and back)

- Calculate and record the Average Length or the Front of the Stack. Repeat the length measurement procedure along the back of the stack and then calculate and record the average length for the stack.

$$\text{Average Stack Length}_{\text{Front}} = (l_1 + l_2 + l_3 + l_4 + l_5) \div 5$$

$$\text{Average Stack Length}_{\text{Back}} = (l_1 + l_2 + l_3 + l_4 + l_5) \div 5$$

$$\text{Average Stack Length} = (\text{Average Length}_{\text{Front}} + \text{Average Length}_{\text{Back}}) \div 2$$

- Width of Stack. This is equal to the Average Length of Pieces that make up the Width of the Stack. Refer to Table 3-5. “Minimum Number of Pieces to be Measured for Length” to determine how many pieces are to be measured. This dimension is calculated by averaging the length of individual pieces of wood in the stack and multiplying it by the number of rows. The wood can be stacked in a single or multiple rows. If the wood is stacked in several rows deep, select a representative random sample from each row. If the wood needs to be stacked, measure the pieces prior to stacking. If the wood is already stacked, select the pieces at random by moving up and down and across the stack. If it is necessary to remove the wood from a stack to measure the individual piece lengths, always complete the height and length measurements before disturbing the stacked wood.

$$\text{Width of Stack} = \text{Average Piece Length (APL)} \times \text{Number of Rows}$$

3. Individual Piece Length. Table 3-5. “Minimum Number of Pieces to be Measured for Length” requires that at least 12 pieces of wood be measured for every half cord estimated to be in the stack.
 - If the wood is uniform in shape, take at least one point-to-point measurement along the center line of the longitudinal axis (see Table 3-6. “Determining Piece Length, (a) “Uniform Shape” for examples) and record the value.
 - If the wood is irregularly shaped (see Table 3-6. “Determining Piece Length, (b) Irregular Shape” for examples), take at least three measurements along a straight line between two points crossing solid wood that appear to be the shortest and longest dimensions, and a third at or near

the center line of the piece. Calculate the average of the measurements to determine Average Individual Piece Length (AIPL) of irregularly shaped pieces:

$$AIPL = (L_1 + L_2 + L_3) \div 3$$

- After all the pieces are measured, total the lengths and divide the total by the number of samples to obtain the Average Piece Length for the stack. To determine Average Piece Length (APL) for the package:

$$APL = (L_1 + L_2 + L_3 + \dots L_n) \div (\text{Number of Pieces in Sample})$$

4. Calculate Volume.

$$\text{Volume in liters} = (\text{Avg. Height [cm]} \times \text{Avg. Width [cm]} \times \text{Average Piece Length [cm]}) \div 1000$$

$$\text{Volume in cubic feet} = (\text{Avg. Height [in]} \times \text{Avg. Width [in]} \times \text{Average Piece Length [in]}) \div 1728$$

5. Supplemental Measurement of Stacked Wood:

- Volume of a Triangle Stack of Wood (see Figure 3-12. “Triangular Stack of Wood”). To calculate the volume of a triangular stack, take at least two measurements (one each side) of the height and length, and five measurements of the width of the stack and average each result. Use this formula to calculate the volume.

$$\text{Volume of Triangular Stack} = (\text{Avg. Height} \times \text{Avg. Length of Base} \times \text{Avg. Width}) \div 2$$

- The volume of the triangular stack may be added to the volume of other stacks.



Figure 3-12. Triangular Stack of Wood.

c. Bundled and Bagged Firewood



Figure 3-13. Firewood Bundle and Bag

3.14.3. Field Audit Procedure – Bundled and Bagged Firewood

A circumference estimating method can be used for quickly identifying potentially short measure bundles. The procedure is based on measuring the circumference of the package ends and calculating the areas without using graph paper. It shall be used for audit purposes only and must not be used for official inspection.

1. After the bundle or bag is secured, use a flexible measuring tape to measure the circumference near each end of the bundle or bag of firewood (see Figure 3-13a. “Strapping the Ends of a Bundle”). Using one movement, extend the measuring tape around the end of the bundle or bag to obtain its circumference (see Figure 3-13b. “Measuring the Circumference of the Bundle”). The tape must be pulled tight. If the wood at the ends of a bag or bundle is not accessible due to plastic wrapping, the wrapping should be moved away from the ends so the measuring tape can be placed tightly around the bundle so circumference measurements can be taken.



Figure 3-13a. Strapping the Ends of a Bundle.

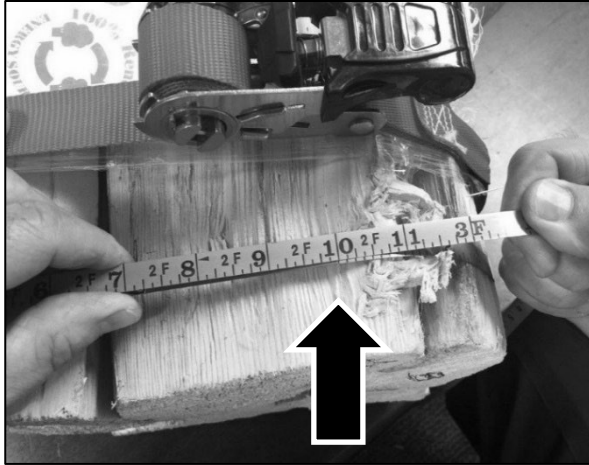


Figure 3-13b. Measuring the Circumference of the Bundle.

At the point of the arrow, the circumference of the bundle is 2 ft 10 in (34 in).

Note: The tape used has a blank end so the “0” line is visible immediately under the 10 in mark.

2. Calculate the Average Circumference:

$$\text{Average Circumference} = (\text{circumference}_1 + \text{circumference}_2) \div 2$$

Example:

If circumference₁ is 34 in and circumference₂ is 33.75 in then:

$$\text{Average Circumference: } 34 + 33.75 \div 2 = 33.875 \text{ in}$$

3. Calculate the Radius:

$$\text{Radius} = \text{Average Circumference} \div 2\pi$$

$$\text{Where: } \pi = 3.1415$$

Example:

$$\text{radius} = 33.875 \div (2 \times \pi \text{ or } 6.283) = 5.39 \text{ in}$$

4. Calculate the Average Area

$$\text{Average Area} = \pi r^2$$

Example:

$$\text{Average Area} = 3.1415 \times 5.39^2 \text{ (or } 29.06) = 91.3 \text{ in}^2$$

5. Calculate the Average Length of the Pieces:

Average length of the pieces of wood – measure the length of several pieces of wood in the bundle or bag. Measurements are to be taken from center to center at the end of each piece.

Then calculate the average:

$$\text{Average length} = \text{sum of the length of all pieces} \div \text{number of pieces}$$

6. Calculate Volume:

$$\text{Volume in liters} = (\text{Average area [cm}^2\text{]} \times \text{Average Length [cm]}) \div 1000$$

$$\text{Volume in cubic feet} = (\text{Average Area [in}^2\text{]} \times \text{Average Length [in]}) \div 1728$$

Example:

Assume the Average Length of the Pieces is 16 in and Average Area is 91.3 in²

$$\text{Bundle Volume} = 91.3 \text{ in}^2 \times 16 \text{ in} = 1460 \text{ in}^3 \text{ or } 0.84 \text{ ft}^3$$

If results indicate that the sample fails, conduct further testing using the reference test procedure for bundles and bags. Do not take any legal action based solely on this audit procedure.

(Amended 2016)

3.14.4. Test Procedure - Bundled and Bagged Firewood

1. Follow Section 2.3.1. “Define the Inspection Lot.” Use a “Category A” sampling plan in the inspection; and select a random sample.
2. Average Area of Bundle Ends:
 - Place a binding strap around each end of the bundle (or bag of firewood) to prevent movement of the pieces during test. Place the straps approximately 10 cm (4 in) from the ends (see Figure 3-14. “A Tightly Wrapped Bundle with Straps Placed at 10 cm [4 in]”) and tighten them securely.

Test Note: To test a bag of firewood remove the firewood from the bag and form a compact bundle and strap it as shown in Figure 3-14. “A Tightly Wrapped Bundle with Straps Placed at 10 cm (4 in),” and follow the procedures for measuring a bundle of firewood.



Figure 3-14. A Tightly Wrapped Bundle with Straps Placed at 10 cm (4 in).

Notice: Do not use shrink wrap or packaging to define the perimeter because it can result in inaccurate measurements.

If necessary, trim the shrink wrap back from the ends to allow for the bundle to sit flat on the graph paper.

- Set one end of the bundle or bag of firewood on graph paper large enough to cover the end completely. Draw a line around the outside of the wood perimeter on the graph paper using a sharp point marking pen (see Figure 3-15. “Tracing Perimeter of the Wood”).
- Count the number of square centimeters or square inches that are enclosed within the perimeter line. Determine portions of square centimeters or square inches not completely within the perimeter line to the nearest one-quarter square inch. Repeat this process on the opposite end of the bundle or bag.

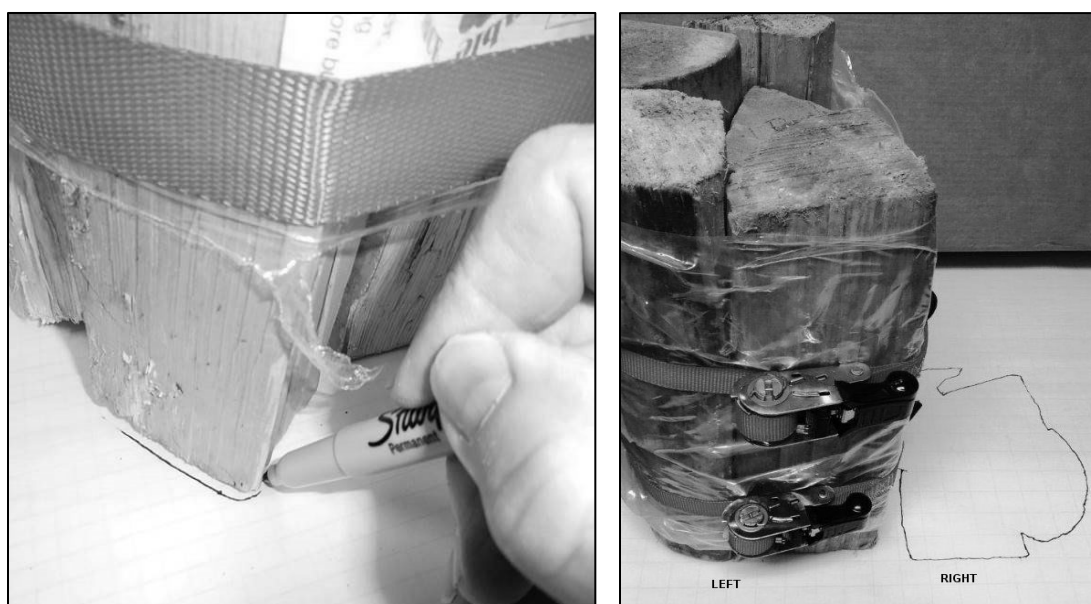


Figure 3-15. Tracing the Perimeter of the Wood.

Examples:

- (1) Using $\frac{1}{4}$ sq in graph paper and a ruler with $\frac{1}{4}$ in graduations, large blocks of the area within the perimeter are quickly measured. This is done by using the ruler to determine the length and then width of the area which are each divided by 0.25 ($\frac{1}{4}$ in) {or multiply 4×7.25 } to obtain the number of blocks in that dimension. These two values are multiplied to obtain the total number of blocks enclosed in the area. The areas in the partially covered blocks are rounded up or down to the nearest $\frac{1}{4}$ in by enclosing the whole square and placing an “x” in the partial spaces which are included in the blocks where the area has been rounded up. One reason for squaring the graph squares is to simplify the counting.
- (2) Use a ruler to count graph squares, the rulers as shown in Figure 3-16. “Perimeter of a Bundle as Defined by the Wood” indicate the dimensions of the square are $7\frac{1}{4} \times 7\frac{3}{4}$ in. To obtain the number of blocks divide 7.25 by 0.25 {or multiply 4×7.25 }. To obtain the number of blocks along the left hand line ($7.25 \div 0.25 = 29$). The bottom line measures $7\frac{3}{4}$ in so $7.75 \div 0.25 = 31$ {or $4 \times 7.75 = 31$ }. Multiply the two values to obtain the total number of squares within the area which is: $29 \times 31 = 899$. To obtain square inches divide 899 by 16 (the number of $\frac{1}{4}$ in graph squares in a square inch) or $899 \div 16 =$ for area of 56.19 in^2 for this area of the bundle.

- (3) Continue to divide the area into blocks to make counting easier and then count the blocks in the remaining areas and sum these values to obtain the total. (see the example in Figure 3-17. “Perimeter of a Bundle of as Defined by the Wood.”) The total number of blocks was calculated by adding:

$$46 + 45 + 899 + 25 + 8 + 54 = 1177 \text{ squares} \div 16 = 73.56 \text{ sq in}$$

for this end of the bundle.

$$\text{Calculate the Average Area: Average Area} = (\text{Area}_1 + \text{Area}_2) \div 2$$

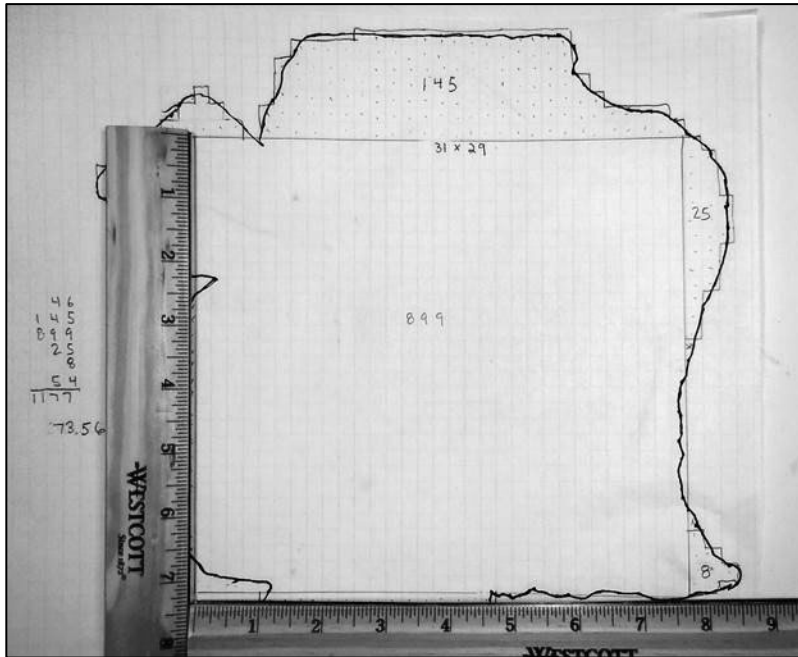


Figure 3-16. Perimeter of a Bundle as Defined by the Wood.

3. Average Length of the Pieces of Wood. Individual piece length, remove the wood from the package and measure the length of each piece of wood (see Table 3-5. “Minimum Number of Pieces to be Measured for Length” for the number of pieces to be measured.) If the piece of wood is uniform in shape, take at least one point-to-point measurement along the center line of the longitudinal axis (see Table 3-6. “Determining Piece Length,” (a) Uniform Shapes for examples) and record the value.
 - If the wood is irregularly shaped (see Table 3-6. “Determining Piece Length,” (b) Irregular Shapes for examples), take at least three measurements along a straight line between two points crossing solid wood that appear to be the shortest and longest dimensions, and a third at or near the center-line of the piece. Calculate the average of the measurements to obtain the Average Individual Piece Length and record the length of the piece.

To determine Average Individual Piece Length (AIPL) of irregularly shaped pieces:

$$AIPL = (L_1 + L_2 + L_3) \div 3$$

Note: If length measurements are made in millimeters divide the total by 10 to obtain centimeters.

- After all pieces are measured, total the lengths and divide that total by the number of samples to obtain the Average Piece Length for the package.

To determine Average Piece Length (APL) for the package:

$$APL = (L_1 + L_2 + L_3 + \dots L_n) \div (\text{Number of Pieces in Sample})$$

4. Use the average values for height, width, and length to calculate the volume of wood in the bundle or bag

- Calculate Volume:

$$\text{Volume in liters} = (\text{Average Area [cm}^2\text{]} \times \text{Average Length [cm]}) \div 1000$$

$$\text{Volume in cubic feet} = (\text{Average Area [in}^2\text{]} \times \text{Average Length [in]}) \div 1728$$

Note: 1 Cubic Foot = 1728 in³, 1 L³ = 1000 cm
(Amended 2016)

3.14.5. Evaluation of Results

Follow Section 2.3.7. “Evaluate for Compliance” to determine lot conformance.

Note: Specified in Appendix A, Table 2-10. “Exceptions to the Maximum Allowable Variations for Textiles, Polyethylene Sheeting and Film, Mulch and Soil Labeled by Volume, Packaged Firewood and Stove Wood Labeled by Volume, and Packages Labeled by Count with 50 Items or Fewer, and Specific Agricultural Seeds Labeled by Count.”

3.15. Test Procedure for Verifying the Useable Volume Declaration on Packages of Animal Bedding

3.15.1. Test Equipment

- Calculator or spreadsheet software
- Standard Package Report Form – Animal Bedding
- Measurement Grid and Package Error Worksheet for Cylindrical and Square or Rectangular Test Measures
- Permanent ink marking pen
- Knife or razor cutter (for use in opening packages and unwrapping shrink-wrapped pallets in warehouses)
- Cellophane tape, Duct tape (for repairing chutes and sealing packages)
- Polyethylene bags (49 L to 113.5 L [13 gal to 30 gal]) (to hold product once it is uncompressed)

- Rigid Rulers – Starrett or equal with 1.0 mm graduations. The edges of a ruler used with a measuring frame must be straight and the edges must be the zero point.
 - 300 mm (12 in)
 - 500 mm (19.5 in)
 - 1 m (39 in)
- Tarp – canvas 3 m × 3 m (10 ft × 10 ft)
- Broom and dust pan
- Levels – for verifying the level of the test measure and taking headspace readings.
 - 152 mm (6 in) Bubble Level
 - 1 m (40 in) Carpenter Level
- Scale 15 kg (30 lb) (only used if the audit procedure is utilized.)
- Chutes for uncompressing and pouring the bedding into a test measure
- Test Measures (see Table 3-8. “Test Measures for Animal Bedding”)

**Table 3-7.
Recommended Chute Dimensions**

Nominal Capacity	Height	Width	Length
70 L (2.5 ft ³)	254 mm (10 in)	228 mm (9 in)	1219 mm (48 in)
100 L (3.5 ft ³)	254 mm (10 in)	279 mm (11 in)	1397 mm (55 in)
170 L (6 ft ³)	279 mm (11 in)	355 mm (14 in)	1727 mm (68 in)
240 L (8.5 ft ³)	304 mm (12 in)	406 mm (16 in)	2006 mm (79 in)
283 L (10 ft ³)	304 mm (12 in)	406 mm (16 in)	2286 mm (90 in)

Note:

Chutes (see Illustration 1. Testing Chutes) may be constructed using hinges and pins so that they lie flat for transporting. They can be constructed of sheet metal or with other slick surface material which enable the bedding to flow easily. The construction of the chutes used in this study allows the sides to move in or out slightly so that the bedding does not become clogged at the outlet. The heights and lengths may be adjusted slightly to fit into vehicles for transport but the widths should not be reduced because narrowing the opening can restrict material flow and result in “bridging” where the bedding collects and creates a block. Also, the width should be kept smaller than the opening of the test measure so that spillage does not occur during pouring.



Illustration 1. Testing Chutes

<p align="center">Table 3-8. Test Measures for Animal Bedding <small>NOTES: a, b, c, and d</small> Only Interior Dimensions are Used for Volume Calculations. Must Be Calibrated with Traceable Measurement Standards Prior to Use.</p>						
<p align="center">Rectangular Test Measures</p>						
<p align="center">Actual Volume of the Measure ^{b & d}</p>	<p align="center">Interior Wall Dimensions</p>			<p align="center">Surface Area</p>	<p align="center">Marked Increments on Ruler</p>	<p align="center">Increment Volume</p>
	<p align="center">Length</p>	<p align="center">Width</p>	<p align="center">Height^d</p>			
<p align="center">31.9 L 1.13 ft³</p>	<p align="center">213.4 mm (8.4 in)</p>	<p align="center">203.2 mm (8 in)</p>	<p align="center">736.6 mm (29 in)</p>	<p align="center">43 362 mm² (67.2 in²)</p>	<p align="center">12.7 mm (0.5 in)</p>	<p align="center">550.6 mL* 0.55 L (33.6 in³)</p>
<p align="center">28.3 L 1 ft³</p>	<p align="center">304.8 mm (12 in)</p>	<p align="center">304.8 mm (12 in)</p>	<p align="center">304.8 mm (12 in)</p>	<p align="center">92 903 mm² (144 in²)</p>		<p align="center">1.18 L** (72 in³)</p>
<p align="center">63.7 L 2.25 ft³</p>	<p align="center">304.8 mm (12 in)</p>	<p align="center">304.8 mm (12 in)</p>	<p align="center">685.8 mm (27 in)</p>			
	<p align="center">406.4 mm (16 in)</p>	<p align="center">228.6 mm (9 in)</p>	<p align="center">685.8 mm (27 in)</p>			
<p align="center">92 L 3.25 ft³</p>	<p align="center">304.8 mm (12 in)</p>	<p align="center">304.8 mm (12 in)</p>	<p align="center">990.6 mm (39 in)</p>			
	<p align="center">406.4 mm (16 in)</p>	<p align="center">228.6 mm (9 in)</p>	<p align="center">990.6 mm (39 in)</p>			

*1.0 mm = 43 mL (2.6 cu in)
 ** 1.0 mm = 92 mL or 0.09 L (5.6 cu in)

This publication is available free of charge from: <https://doi.org/10.6028/NIST.HB.133-2023>

Square Test Measures						
Actual Volume of the Measure ^{b & d}	Interior Wall Dimensions			Surface Area	Marked Increments on Ruler	Increment Volume
	Length	Width	Height ^d			
77.4 L (2.73 ft ³)	381 mm (15 in)	381 mm (15 in)	533.4 mm (21 in)	145 161 mm ² (225 in ²)	1.0 mm (0.03937 in)	0.14 L (8.5 in ³)
144 L (5.09 ft ³)	508 mm (20 in)	508 mm (20 in)	558.8 mm (22 in)	258 064 mm ² (400 in ²)		0.25 L (15.2 in ³)
283 L (10 ft ³)	609.6 mm (24 in)	609.6 mm (24 in)	762 mm (30 in)	371 612 mm ² (576 in ²)		0.37 L (22.5 in ³)
Cylindrical Test Measures						
These dimensions are based on the tube having a 1/4 inch wall thickness. Other tube thicknesses may be used.						
Actual Volume <i>Volume = $\pi r^2 h$</i>	Interior Diameter (Outside Diameter)	Height	Surface Area <i>Area = πr^2</i>	Increment	Increment Volume	
52 L (1.8 ft ³)	292.1 mm (304.8 mm) 11.5 in (12 in)	780 mm (30.70 in)	67 012 mm ² (103.8 in ²)	1.0 mm (0.03937 in)	0.06 L (4 in ³)	
124 L (4.3 ft ³)	444.5 mm (457.2 mm) 17.5 in (18 in)	800 mm (31.49 in)	155 179 mm ² (240.52 in ²)		0.15 L (9.4 in ³)	
279 L (9.8 ft ³)	596.9 mm (609.6 mm) 23.5 in (24 in)	1000 mm (39.37 in)	279 829 mm ² (433.76 in ²)		0.27 L (16.4 in ³)	
Notes						
<p>a. Rectangular and Square Based Dry Measures are typically constructed of 12.7 mm to 19.05 mm (0.5 in to 0.75 in) marine plywood. A 4.76 mm (³/₁₆ in) transparent sidewall is useful for determining the level of fill, but must be reinforced or be made of thicker material if it distorts when the measure is filled. If the measure has a clear front, place the level gage at the back (inside) of the measure so that the markings are read over the top of the animal bedding. Any of these measures may be made without an attached bottom for ease of emptying if they are placed on a solid level base during filling and measurement.</p> <p>b. Other size measures may be used if calibrated and the volume equivalence of the increment of 1.0 mm is no greater than 1/6 the MAV. Widening the base of a measure reduces the column height of the product and will reduce compression but the trade-off is that the larger surface area increases the volume so the potential for measurement errors increase. One of the benefits of the cylindrical design is that, in addition to eliminating the 90 degree angles of the corners where gaps in fill frequently occur, the surface area of a cylinder is less than an equal volume square measure and that results in better resolution in the volume measurements (i.e., compare the readability of a 24 in sq box which has a surface area of 576 in², to the 24 in cylinder which has a surface area of 433 in²). The height of the test measure may be reduced, but this will limit the volume of the package that can be tested.</p> <p>c. If lines are marked in any test measures, they should extend around all sides of the measure if possible to improve readability. It is recommended that a line indicating the MAV level also be</p>						

marked to reduce the possibility of reading errors when the level of the product is at or near the MAV.

- d. If the measures are built to the dimensions shown above, the actual volume of most of the measures will be larger than the nominal volume so that plus errors (overflow) can be measured accurately.

Test Note: Nothing in this section should be construed or interpreted as prohibiting the use of test measures meeting these specifications, or constructed in other geometric shapes or dimensions, or those made of other materials to test any other products.

3.15.2. Test Procedure

Test Notes:

Rounding: When a volume measurement falls between graduations on a ruler, round the value in the direction that favors the packer. This practice eliminates the issue of rounding from the volume determination and provides packagers the benefit of the doubt. The ruler graduation is 1.0 mm so the rounding error will be limited to 0.5 mm or less. It is good practice to circle a measurement that has been rounded up or make a statement to such effect so that it becomes a part of the inspection record.

Safety Precautions:



This procedure does not address all of the safety issues that users need to be aware of in order to carry out the following tasks. Users are sometimes required to conduct test in warehouse spaces or retail stores where fork-trucks are in motion – care must be taken to warn others to avoid or exercise care around the test site. The procedure requires users to lift heavy objects including large bulky packages and test measures and includes the use of sharp instruments to obtain packages from shrink-wrapped pallets. Users may be required to climb ladders or work platforms to obtain packages. When opening and emptying packages, dust, and other particles may be present or escape from the packages which may cause eye injuries and respiratory or other health problems. Users must utilize appropriate safety equipment and exercise good safety practice. If safe working conditions cannot be ensured, suspend testing until the situation is corrected.

1. Follow Section 2.3.1. “Define the Inspection Lot” select “Category A, Sampling Plan” in this inspection. Determine the Sample Size based on the size of the Inspection Lot using Category A. Collect the sample packages from the Inspection Lot using Section 2.3.4. “Random Sampling Selection.”

Test Notes:

- (1) Place the test equipment and sample packages in a location where there is adequate lighting and ample space around the packages and equipment so the packages can be opened and the chutes and test measures used safely.
- (2) If the package is not labeled with a usable volume, it is opened and the contents are poured directly into the test measure.

Optional – Audit Screening by Weight

The full test procedure requires that all of the packages be opened for testing. Regardless of the type of bedding, the product cannot be returned to the original package. An alternative gravimetric auditing procedure may be used to reduce the amount of destructive testing and conserve inspection resources.

Audit Procedure: After randomly selecting the sample packages from the Inspection Lot, obtain the gross weight for each package. Select the lightest and heaviest packages and conduct a usable volumetric test these two packages. If the lightest and heaviest packages pass (i.e., each contains at least the useable volume declared on the label), it is highly likely that the remaining packages in the sample will also pass. Accept these two package samples as an AUDIT TEST and move on to inspect other types of bedding or Inspection Lots of other types or brands of bedding. If either of the two packages is found to have a minus error that exceeds the Maximum Allowable Variation, the sample fails. No further testing is required (i.e., assuming no MAV is allowed for the sample size (see Appendix A, Table 2-1. “Sampling Plans for Category A”).) If either of the packages is found to have a minus error that does not exceed the MAV, continue to test all of the packages and take action based on the final results from the complete sample.

Test Note: If the gravimetric audit procedure is used, ensure the scale is placed on a solid level support, and its accuracy has been verified to a test load that is at least 10 % more than the gross weight of the packages (e.g., to estimate the load, place one of the packages on the scale and then test the scale with a load above the package’s gross weight). See Section 2.2. “Measurement Standards and Test Equipment” for additional information.

2. Select the appropriate test measure for the package size.
 - Spread a tarp large enough to hold a chute and test measure.
 - Place the chute and test measure on the tarp. Verify that the test measure is level.
3. Select a chute of appropriate capacity (see Table 3-7. “Recommended Chute Dimensions”) for the package size and position it on the tarp.
4. Open the packaging, uncompressing and pouring the bedding into the test measure twice.
 - **Open Package:** Place the package in the chute and use a knife or box cutter to open and remove the wrapper. Spread the bedding uniformly along the length of the chute. The bedding is uncompressed in two steps. The first step is to loosen the clumps of bedding by gently pulling them apart (do not tear the fibers of cellulose bedding or “grind” any bedding between your hands because these practices break the material down). Spread your fingers and pick the material up using your hands from beneath to loosen it up. There should be no clumps of bedding in the chute. If any bedding has fallen out of the chute onto the tarp, collect it and return it to the chute. The following pictures illustrate this step of the procedure. The second step of the expanded volume recovery process is to pour the bedding into a test measure as described in Step 2.



Figure 3-18. Spreading Bedding



Figure 3-19. Loosening the Clumps of Bedding Material.



Figure 3-20. First Pour into the Test Measure.

- **First Pour:** The first pour into the test measure is only used to further un-compress the bedding so no measurements are taken. Hold the chute above the test measure and tilt it so that you pour the bedding into the center of the test measure. The bedding should be poured slowly into the test measure in one continuous stream and not “dumped” (if it is “dumped” or poured too quickly some of the bedding will blow out of the measure or the bedding will be packed down and its volume reduced). The flow rate should be controlled by the tilt angle of the chute. The chute itself can be shaken but **DO NOT HIT OR SHAKE THE TEST MEASURE**. Also, do not touch the product to facilitate flow. (Do not adjust the flow by closing the opening of the chute as that may cause the bedding to heap up and then fall into the measure in clumps, which may result in impact compression). Empty the bedding back into the chute and spread it out evenly along its length.



Figure 3-21. How to Hold a Chute for the Pour.



Figure 3-22. How to Cradle the Chute. Cradle the chute on one arm while holding it with one hand and tilting the cradle with the other hand.

- **Second Pour:** The second pour into the test measure is used to make the volume determination. Hold the chute above the test measure and tilt it so that you pour the bedding into the center of the test measure. The bedding should be poured slowly into the test measure in one continuous stream and not “dumped.” The flow rate should be controlled by the tilt angle of the chute. The chute can be shaken but **DO NOT HIT OR SHAKE THE TEST MEASURE.**

Test Note: Stop filling the measure if it appears that the test measure will overflow. The overflow product should be measured separately (use a smaller test measure of adequate size and capacity if one is available) and the multiple measurement volumes are added. If pouring into a square test measure, pour at an angle to two corners for the widest opening (see Figure 3-24. “Filling a Test Measure”).



Figure 3-23. Filling a 44 L Test Measure.



Figure 3-24. Filling a Test Measure at an Angle to use the Larger Opening.

5. Volume Determination.

DO NOT HAND LEVEL THE SURFACE OF THE BEDDING AS MANUAL LEVELING “PACKS” THE BEDDING AND REDUCES ITS VOLUME. DO NOT JAR OR SHAKE THE TEST MEASURE

Test Note: Before using a test measure for volume determinations, place a level of adequate length on top of the test measure at approximately three equal measuring points across the top. A permanent marking pen can be used to evenly space the marks across the top edge of the test measure so that it can be positioned to take the measurements. (see Figure 3-25. “Marking Evenly Spaced Measuring Points.”)

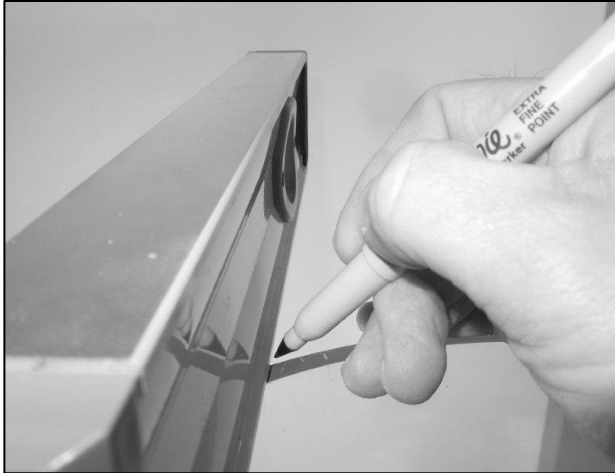


Figure 3-25. Marking Evenly Spaced Measuring Points across the top of the test measure.

- Place a rigid level or straight edge of adequate size on top the test measure and select a ruler of adequate length to reach to the lowest level of the top surface of the bedding. Start at the measuring points to your left or right, place the ruler against the side of the level, and hold it with either hand. The zero graduation is pointed down so the ruler can be lowered into the test measure for measurement. Lower the ruler into the test measure slowly until its end is at the surface level of the bedding (see Figure 3-26. “Placing the Ruler into the Test Measure with Zero End Down” and Figure 3-27. “Ruler Shown with Zero End at the Bedding Surface”).



Figure 3-26. Placing the Ruler into the Test Measure with Zero End Down.

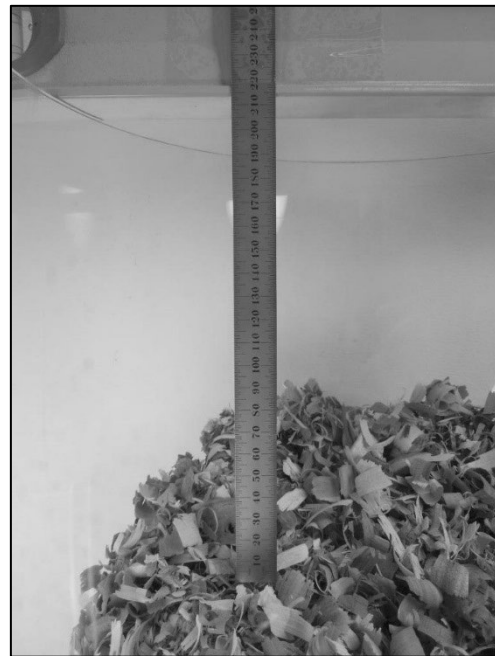


Figure 3-27. Ruler Shown with the Zero End at the Bedding Surface.

- Determine the depth of each measurement point from the surface of the bedding to the bottom edge of the straight edge and record the value in the appropriate space on the worksheet. Take a minimum of nine measurements (at least 9 for cylindrical measures)

across the top of the test measure in a grid pattern. Read the graduations on the ruler from a position that minimizes errors caused by parallax.

Table 3-9.
Illustrations of Depth Determinations with Cylindrical Test Measures



Illustration 1. Reading the Depth of the Container. This photo illustrates how to read the depth of container.

The picture on the left (Illustration 1) shows how to read the depth from the bottom of the straightedge (top edge of measure) down to the bedding in a 44 L test measure from a position that reduces parallax. The graphic below (Illustration 2) illustrates the actual worksheet with the headspace procedure on the 44 L cylinder test measure (its internal radius is 151.77515 mm and its height is 610 mm). The bedding was poured into the test measure but not leveled. Then nine measurements were made at the locations shown on the grid to determine the depth of the product from the top edge of the measure. The average of the nine values was 479.88 mm which was subtracted from the height of the test measure to obtain 130.12 mm for the average height of the column of bedding in the measure.

The volume was calculated using:

$$Volume\ in\ liters = (\pi r^2 h) \ 3.14159265 (Pi) \times 23035.69\ mm \times 130.12\ mm = 9.41\ L^*$$

*After the calculation was completed the result was divided by 1 000 000 to obtain the volume in liters.

Illustration 2. Illustration of Worksheet.

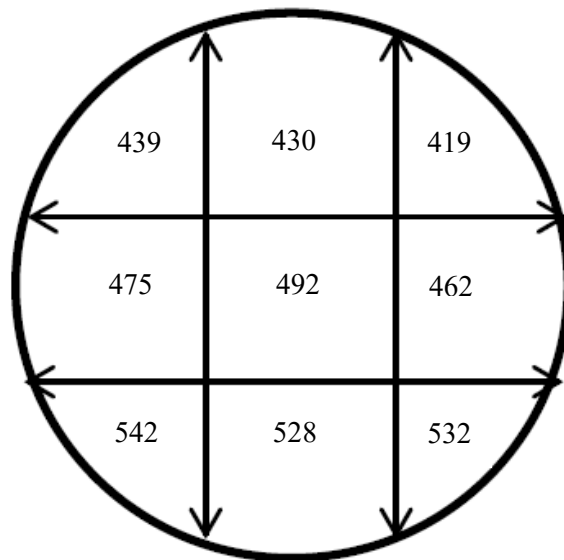


Table 3-9.
Illustrations of Depth Determinations with Cylindrical Test Measures



Illustration 3. Using the headspace measurement on a 279 L test measure. The ruler is read from the bottom edge of a straight edge or level from a position that reduces parallax.



Illustration 4. Illustrating how the ruler is placed on the bedding with the headspace method. The ruler is read from the bottom edge of a straight edge or level from a position that reduces parallax.

Table 3-10.
Illustrations of Depth Determinations with Square Test Measures



Illustration 1. Depth Determination.

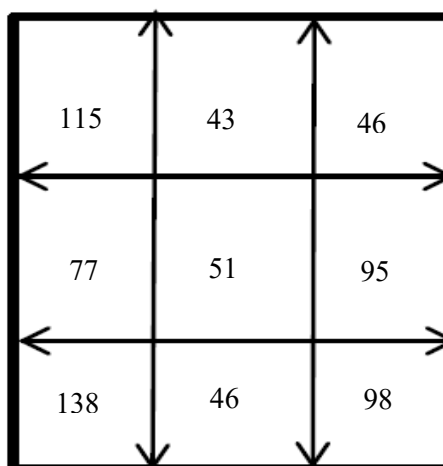


Illustration 2. Measurement Grid for Headspace Measurement Procedure.

The picture on the left (Illustration 1. Depth Determination) shows how to read the depth from the bottom of the straightedge (top edge of measure) down to the bedding in a 283 L square test measure from a position that reduces parallax. The graphic on the right (Illustration 2. Measurement Grid for Headspace Measurement Procedure) illustrates the actual worksheet with the headspace procedure on the square test measure (its internal dimensions are 609.6 mm × 609.6 mm × 762 mm (24 in × 24 in × 30 in)). The bedding was poured into the test measure but not leveled. Then nine measurements were made at the locations shown on the grid to determine the depth of the product from the top edge of the measure. The average of the nine values was 78.77 mm that was subtracted from the height of the test measure to obtain 683.23 mm for the average height of the column of bedding in the measure.

The volume was calculated using:

$$Volume\ in\ liters = lwh\ 609.6\ mm \times 609.6\ mm \times 683.23\ mm = 253.89\ L^*$$

*After the calculation was completed, the result was divided by 1 000 000 to obtain the volume in liters.

Table 3-10.
Illustrations of Depth Determinations with Square Test Measures



Illustration 3. Using the headspace measurement on 56.6 L (2 cu ft) test measure. The ruler is read from the bottom edge of a straight edge or level from a position that reduces parallax.



Illustration 4. Showing how the ruler is placed on the bedding with the headspace method. The ruler is read from the bottom edge of a straight edge or level from a position that reduces parallax.

6. Using the Worksheet for Volume Calculation

- Enter the sample number of the package on the worksheet along with its labeled usable volume.
- Test Measure Information
 - For a cylindrical test measure, enter its interior height and radius in the spaces labeled A and B.
 - For a square or rectangular test measure enter its interior height and the area of its base (i.e., length × width) in spaces labeled A and B.
- Sum the measurements in the grid, divide the value by the number of measurements (i.e., 9), and enter this value in the space labeled C, Average Depth.

- Calculate the Average Height of the Bedding (subtract C [Average Depth] from A [Interior Height of Test Measure]) and enter this value in the space labeled D.
- Calculate the Volume of Bedding in the Package:

- For a cylindrical test measure, the formula ($Volume\ in\ Liters = \pi r^2 h$) is shown on line E on the worksheet. It is:

$$Volume\ (Liters) = 3.14159265 \times r^2\ (B^2) \times Average\ Height\ (D) \div 1\ 000\ 000.$$

Enter the package volume in the space provided for this value in line E.

- For a square or rectangular test measure the formula ($Volume\ in\ Liters = LWH$) is shown in line E on the worksheet. It is:

$$Volume\ (Liters) = B\ (Area\ of\ Test\ Measure\ Base) \times D\ (Average\ Height) \div 1\ 000\ 000.$$

Enter the package volume in the space provided for this value in line E.

- Calculate the Package Error using the following formula:

- Package Error = Labeled Usable Volume (Liters) – E Package Volume (Liters)

$$Package\ Error\ (Liters) = Labeled\ Expanded\ Volume - Package\ Volume$$

- Transfer the individual package errors (verify whether they are positive or negative) to the “Standard Package Report – Animal Bedding” in Appendix D. Fill in the required header information. For Box 7, “Number of Unreasonable Package Errors Allowed for Sample Size”, use Appendix A Table 2-1. “Sampling Plans for Category A”, “Column 4.”, Based on the sample size, determine how many packages may have minus package errors that exceed the MAV (i.e., unreasonable package error).

THEN:

- Calculate the Total Error (Enter in Box 8. “Total Error”).

(Amended 2016)

3.15.3. Evaluation of the Test Results and Determination of Pass or Fail

1. Determine if any of the minus package errors exceeds the MAV. Apply a MAV value of 5 % ($0.05 \times$ labeled expanded volume) to single measurement volume determinations. If none of the minus package errors exceeds the MAV, go to Step 3. If any of the minus package errors exceed the MAV, enter the number of packages in Box 9 “Number of Unreasonable Minus Errors”. Go to Box 10 “Is Box 9 Greater than Box 7?” and determine if the value exceeds the number in Box 7 “Number of Unreasonable Package Errors Allowed for Sample Size”. If the number of packages with unreasonable errors exceeds the number permitted in Box 7 “Number of Unreasonable Package Errors Allowed for Sample Size,” the sample fails. Go to Box 17 “Disposition of the Inspection Lot” and reject the Inspection Lot.
2. Calculate the Average Error for the sample by dividing Box 8 “Total Error,” by Box 6 “Sample Size” and enter the value in Box 11 “Calculate Average Error,” then go Box 12 “Does Box 11

- equal Zero or Plus?” If the Average Error is zero or a positive number the sample passes, go to Box 17 “Disposition of the Inspection Lot” and approve the inspection lot. If the Average Error is a negative value go to Step 3.
3. Calculate the Sample Standard Deviation and enter in Box 13. “Compute Sample Standard Deviation.” To obtain the Sample Correction Factor for the sample size use Appendix A, Table 2-1. “Sampling Plans for Category A,” Column 3 “Sample Correction Factor” and enter that in Box 14 “Sample Correction Factor.” Then calculate the Sample Error Limit by multiplying Box 13 “Compute Sample Standard Deviation” and Box 14 “Sample Correction Factor.” Enter the value in Box 15 “Compute Sample Error Limit.”
 - Disregarding the signs, determine if the minus in Box 11 “Calculate Average Error” is larger than the value in Box 15 “Compute Sample Error Limit.”
 - If yes, the sample fails, go to Box 17 “Disposition of Inspection” and reject the Inspection Lot.
 - If no, the sample passes, go to Box 17 “Disposition of Inspection” and approve the Inspection Lot
 4. Prepare a comprehensive report of the test results and enforcement action taken and present the information to the party responsible for the product.
- (Amended 2016)