

Moving from “React and Repair” to “Predict and Prevent”

NIST Industry Forum

May 8-9, 2018

SIEMENS
Ingenuity for Life



Validation of the Intelligent Edge

Panel - Emerging Sensing Technologies to Enable Monitoring, Diagnostics, and Prognostics

Dr. Justinian Rosca – Siemens Corporation, Corporate Technology, Princeton, NJ

Corporate Technology – Innovating Globally

Corporate Technology – worldwide locations

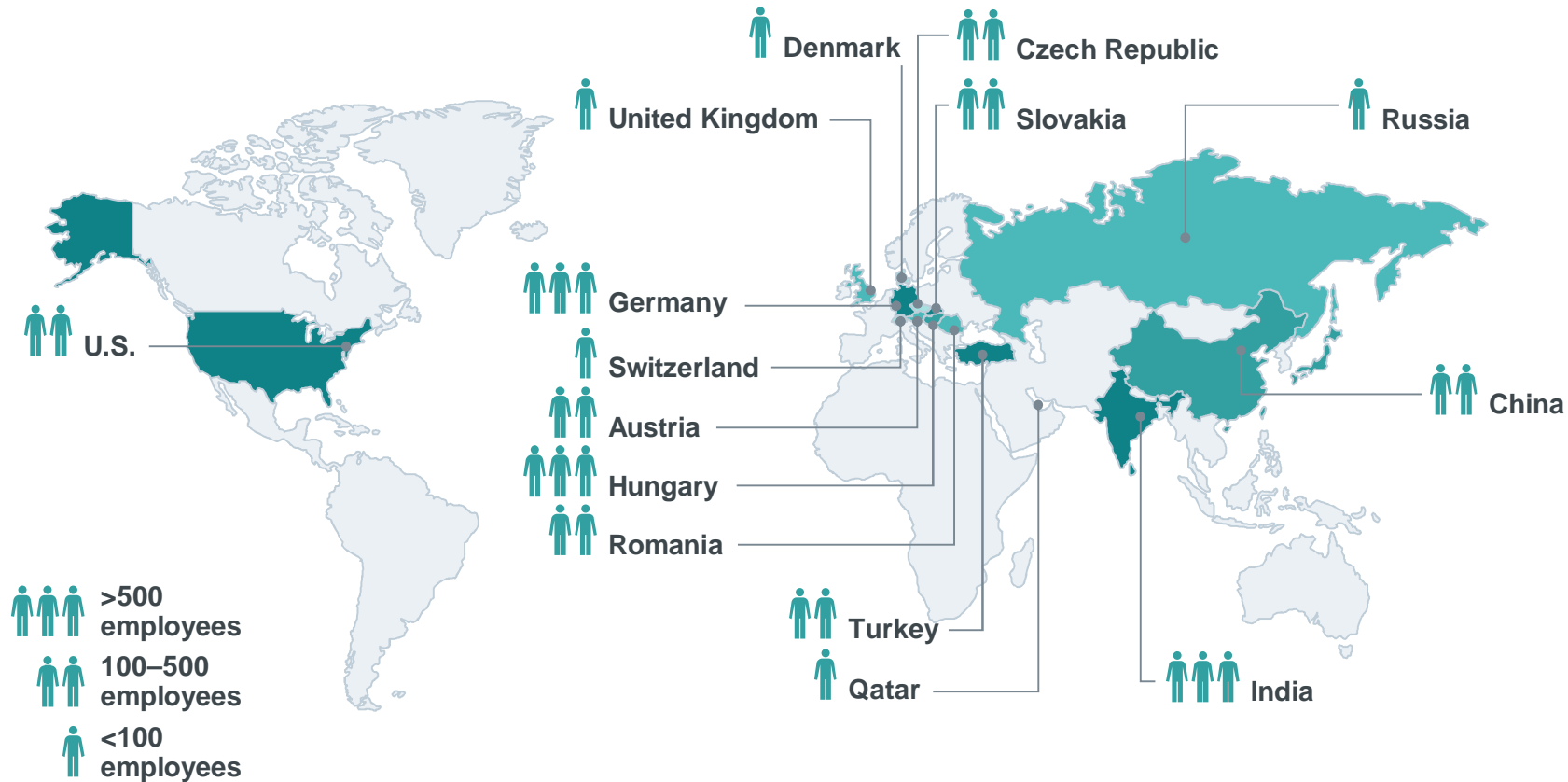

A worldwide presence

is the heart of the Siemens brand – and that goes for us as well.

This presence enables us to quickly offer targeted solutions that are tailored to regional requirements.

CT Focus in Digitalization and Automation – Securing and Extending Technology Leadership

SIEMENS



Cyber Security

Enabling Digitalization



Edge Computing for Monitoring, Diagnostics, and Prognostics

- Prognostics predicts the future performance of a component, machine or system by analysis of failure modes, detection of early signs of wear, aging, and fault conditions
- “**Edge computing**” performs data processing near the source of the data at the edge of the network (vs. cloud computing in the data center), and is more capable to respond to application latency, bandwidth, privacy, availability requirements
- Keywords in the field of Prognostics and Health Management (PHM): *data-driven prognostics, model-based prognostics, fusion of models and data, ...*
- Many of the core technological innovations for advancing maintenance strategies (e.g., moving from preventive to predictive) come from the fields of *Machine Learning and Artificial Intelligence*.



Source: [Siemens, Failsafe SIMATIC S7-1500-based reliable operation for Jowa Bakery, Switzerland, 2018]

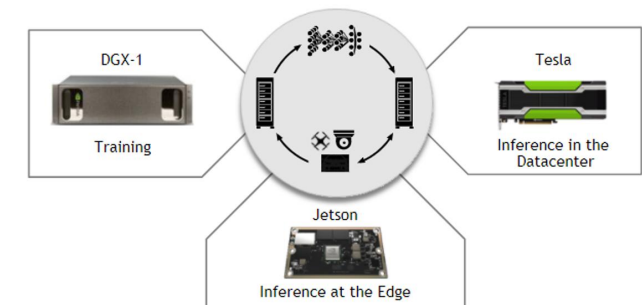

Source: [NVIDIA, AI in the Edge, 2018]

“Intelligent Edge”

Intelligent Edge: Machine Learning for Monitoring and Prognostics

- Machine Learning (ML) is essential in PHM
- Offers a powerful toolkit for building useful complex prediction systems **quickly and cheaply**, but...
- Examples PHM Data Challenge:
 - 2015: “Predicting plant control failure events”
 - 2016: “Combination of physics-based modeling and statistical approaches for prediction of polishing removal rate of material in Chemical-Mechanical Planarization”
 - 2017: “Predict faulty regimes of operation of a train car using data-based and physics-based modeling

Metaphor for Artificial Intelligence (AI) and Machine Learning (ML)

$$\text{act}^* = \underset{a \text{ in actions}}{\text{argmax}} \mathbb{E}(\text{Utility}(a, s))$$

Diagram illustrating the components of the equation:

- PROBABILISTIC INFERENCE** (above the expectation symbol \mathbb{E})
- STATE ESTIMATION** (below the state variable s)
- PLANNING** (below the argmax operation)

[P. Norvig, “Verification and Validation of AI Software,” IJCAI 2016]

Machine Learning for Monitoring and Prognostics

Data collection, serving infrastructure (from sensing to computing and communications), configuration, resource management, monitoring, process management, etc.

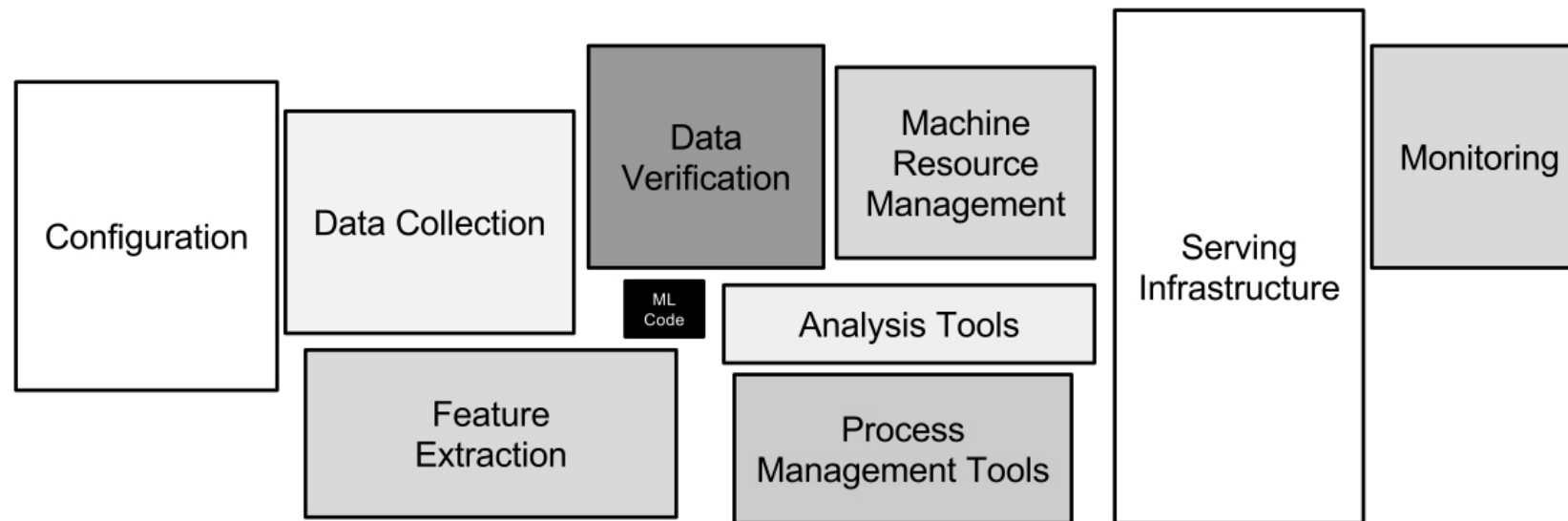

[D. Sculley et al., "Hidden Technical Debt in Machine Learning Systems," NIPS 2017]

Machine Learning "plumbing" is overwhelming!

Run Time Prognostics in the Intelligent Edge

- **Core technology steps:**
 - **Scope** the most important failures and inefficiencies
 - **Installation / reuse of sensors or edge devices** and connectivity/networking
 - **Anomaly detection**
 - **Online monitoring**
 - **Reasoning / Prognostics**
 - **Cloud services**
- **Business components beyond “plumbing:”**
 - **Engineering:** domain engineering knowledge captured by “**digital twin**”
 - **Programming:** software that evolves over lifecycle of the product, its **verification and validation**
 - **Data management:** acquisition, storage, historization of high resolution high dimensional data
 - **Reusable runtime stack:** software deployable on a variety of hardware platforms



[Siemens, PLM Software, 2018]

Example: Edge Monitoring and Prognostics for High Speed Trains

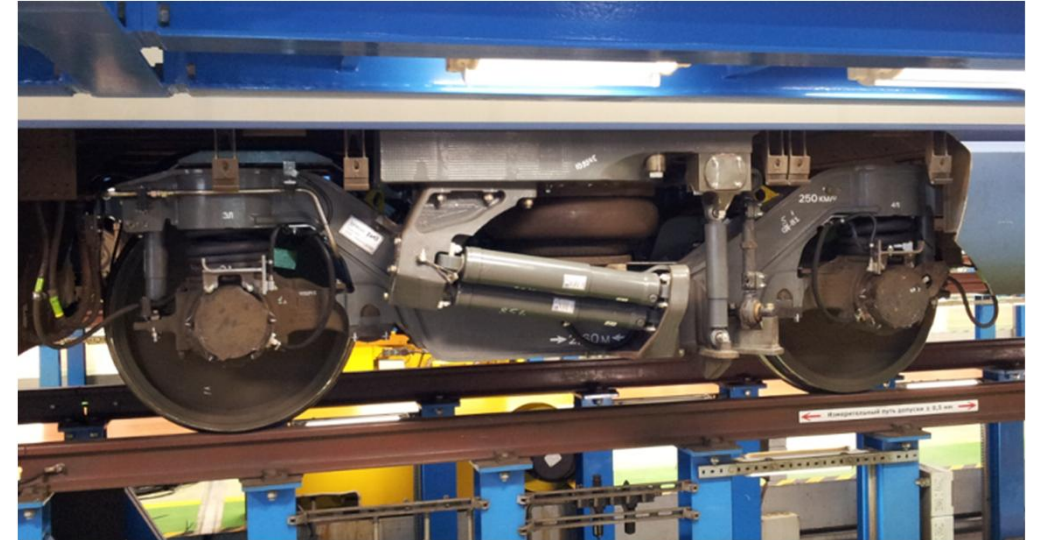
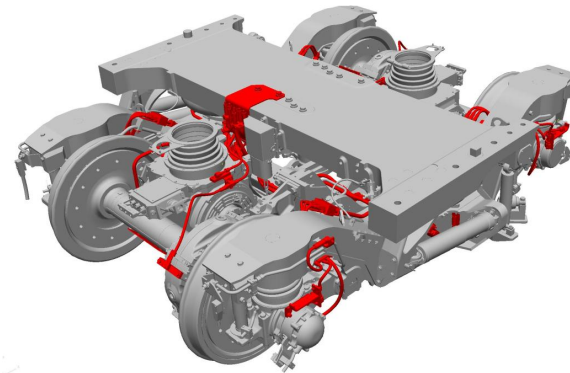

[Siemens MO, 2017]

Raw, time domain accelerometer data to determine the status of tens of variables with physical meaning for each car and bogie and perform statistical inference to reason about the state and reliability of all the car components

[J. Rosca et al., "PHM Data Challenge" PHM 2017]

Intelligent Edge Builds on Synchronization of the Real and Digital Worlds

Digital replica of the physical system or Digital Twin provides the elements and the dynamics, uses simplified physical principles, and is basis for monitoring, diagnostics and prognostics in the **intelligent edge (IE)**

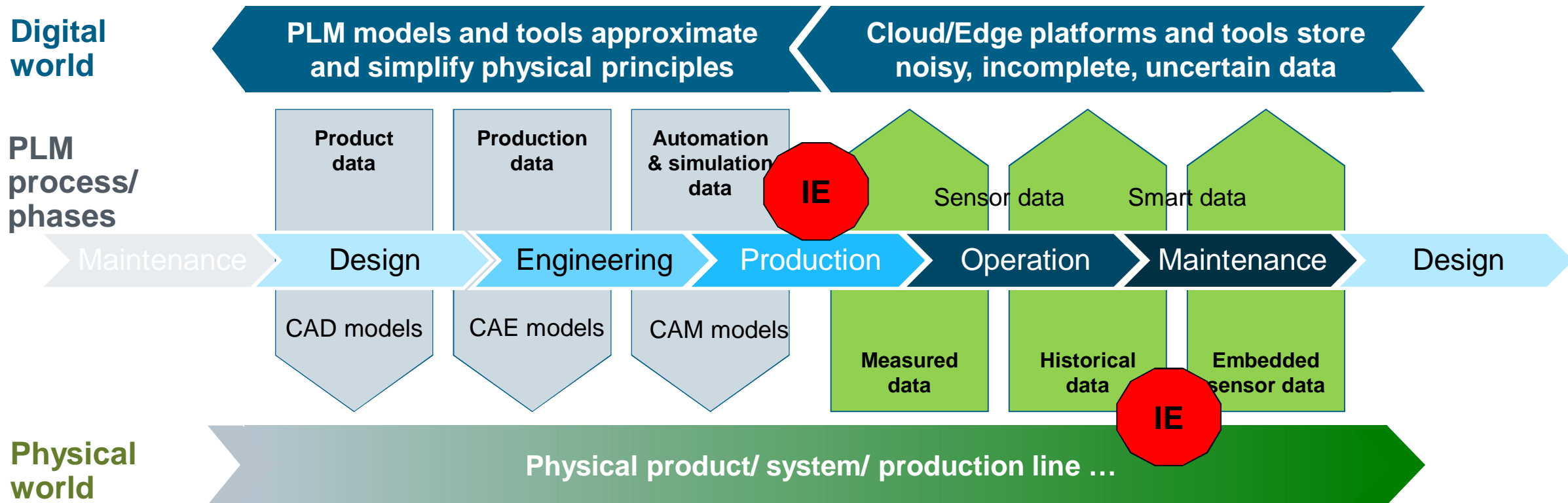

Siemens PLM software maps entire factory and production cycles into software as a “Digital Twin”: NX, Teamcenter

Verification and Validation Costs

Maintaining a digital twin over (life) time is difficult and expensive

- Requirements, design, code to testing and operation digital thread
- “Costs are... much higher than initially planned!”
- “Verification and validation costs more than software development!”

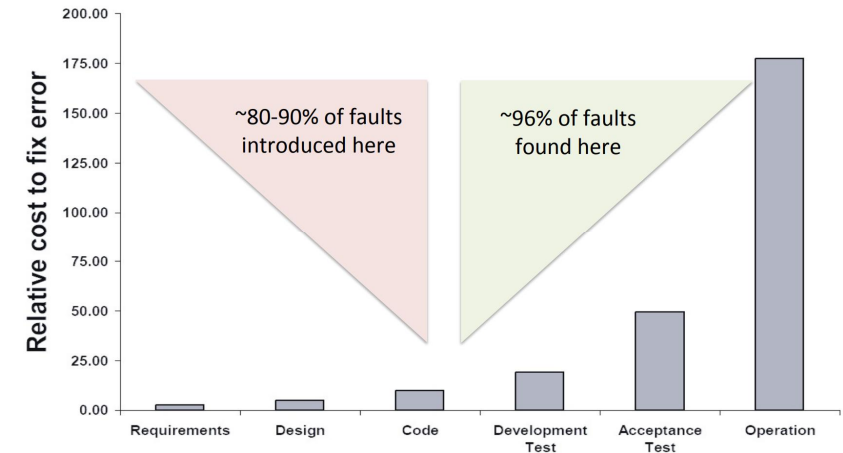

[G. Brat, NASA Ames, “Reducing Cost of V&V for Flight Critical Systems,” S5 Talk, 2016]

Moreover ... maintaining Machine Learning incurs extra costs known as “technical debt”

[D. Sculley et al., “Hidden Technical Debt in Machine Learning Systems,” NIPS 2017]

- ML code has all of the maintenance problems of traditional code + ...
- Issues exist at the system level rather than the code level
- Data influences ML system behavior, traditional abstractions and boundaries are invalidated

Intelligent Machines

- Requirements **frequently change** during operations
- System adaptation yields **unforeseen** configurations
- **Unknown** environments trigger unpredictable runtime decisions

Account for ML costs in system design

Trust and Safety

Beyond “cost”: trust, transparency, safety

“Artificial Intelligence (AI) is useful. AI can deliver more functionality for reduced cost. AI should be used more widely but won’t be unless developers can trust adaptive, nondeterministic, or complex AI systems.”

[T. Menzies et al., “Verification and Validation and AI”, Elsevier 2005]

Challenges of implementing PHM at the edge

- Cost and complexity
- Trust, transparency - apply strong (run-time) verification methods
- Safety – From Safety Integrity Level (SIL) for failsafe operation to ML software run-time assurances - apply strong (run-time) verification methods

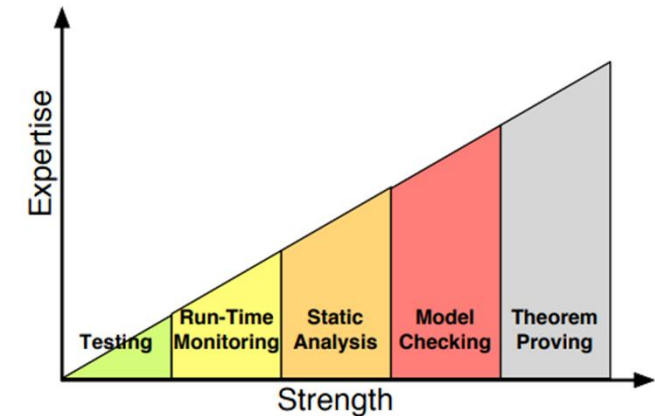

Intelligent edge role:

- (1) Monitoring, diagnostics and prognostics***
- (2) Safety, reliability and trust***

Validation of the Intelligent Edge

Multidimensional challenge: Safe, trustworthy machine intelligence is essential from multiple perspectives in deployed systems

- Industry sets the course for testing and validation of complex systems “under all conditions”
- Scientists and engineers deal with validation and software assurances (including at run-time)
- Independent organizations and stakeholders do verification and validation
- Policy makers decide about trust and safety **rules** to be plugged in

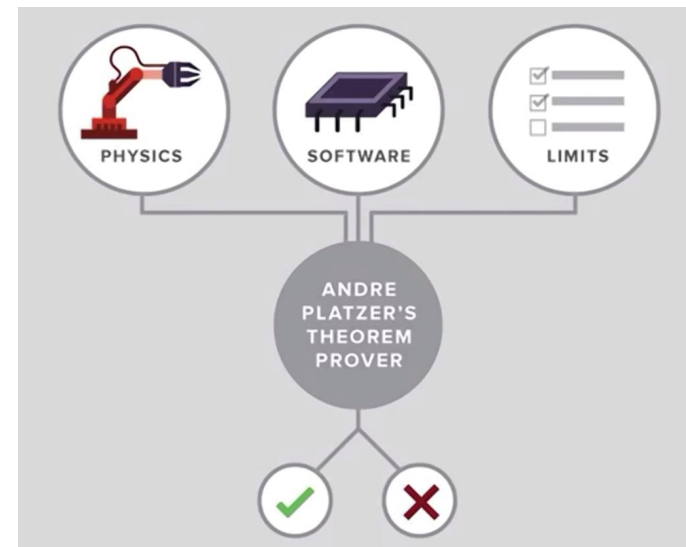

From [A. Moore, “Verifying and Validating Machine Intelligence”, WEF 2017]

Broader view of edge intelligence;

Standards and collective engagement of many stakeholders for predictive intelligence (in the edge)!