

Ion traps for quantum information processing at NIST

Yves Colombe
for the **NIST Ion Storage Group**, Boulder

Workshop on Ion Trap Technology, NIST Boulder, Feb. 16-17, 2011



Outline

- Improvements on the quantum computing experiment
- Magnetic gates on an ion chip
- Fluorescence collection with fiber optics
- Coupled quantized mechanical oscillators
- Ion as a surface probe

- Good qubits (${}^9\text{Be}^+$)
 - state preparation and readout
 - long coherence time (15 s)
- Universal gates set
 - laser-induced 1 and 2-qubit gates
- Information transport
 - multi-zone trap
 - sympathetic cooling with ${}^{24}\text{Mg}^+$
- Current work
 - higher fidelity
 - more efficient processing

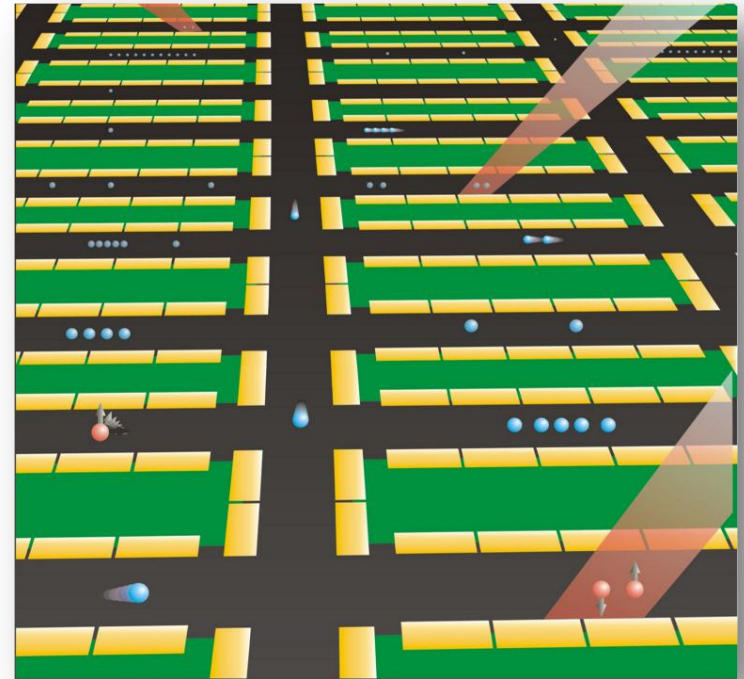

Arbitrary two-qubit operations: D. Hanneke *et al.*, Nature Physics **6**, 13 (2010)

Methods set: J. P. Home *et al.*, Science **325**, 1227 (2009)

Entangled mech. oscillators: J. D. Jost *et al.*, Nature **459**, 683 (2009)

D. Hanneke
J. D. Jost
J. P. Home
R. Bowler
Y. Lin
T.-R. Tan

The quantum information processor



the optics
jungle



ions live here

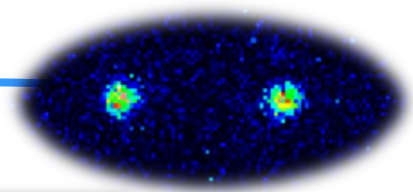

Scalable Mølmer – Sørensen gate

$$\sigma_z \otimes \sigma_z$$

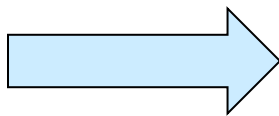

$$\sigma_y \otimes \sigma_y$$

- Does not work on qubit states directly
 - requires differential ac Stark shift
 - need to map around ${}^9\text{Be}^+$ hyperfine manifold
- Two laser beams

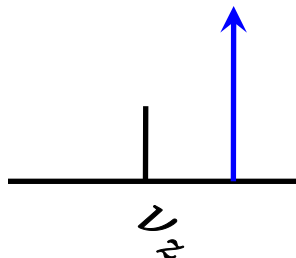

Gate errors:

- Works on qubit states directly
- At least three laser beams

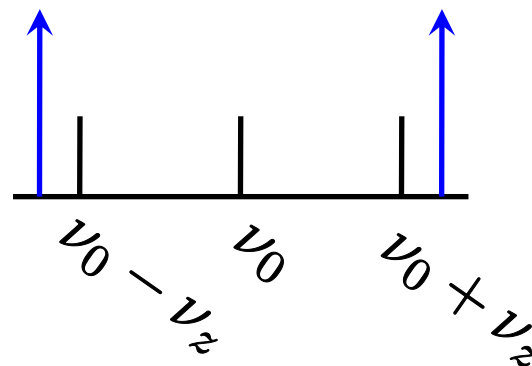

Error sources	Old	New
Single-qubit pulses	2.3% 6 per ion	0.8% 2 per ion
Spontaneous emission	1.5%	1.5% *
Laser control	1.5%	1.5% *
Motional coherence	0.1%	0.1%

Improved beam pointing stability

Air turbulence + thermal gradients...

- Box the laser table
- Actively stabilize the position
- Water-cool some AOMs

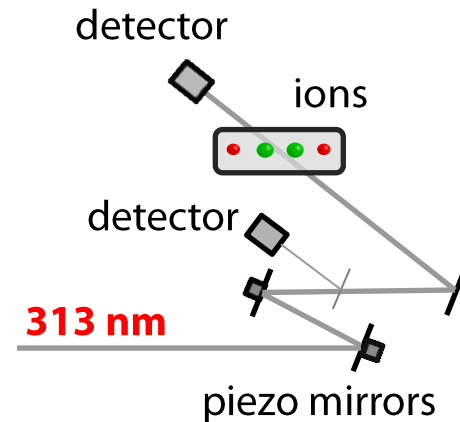

Rabi flopping

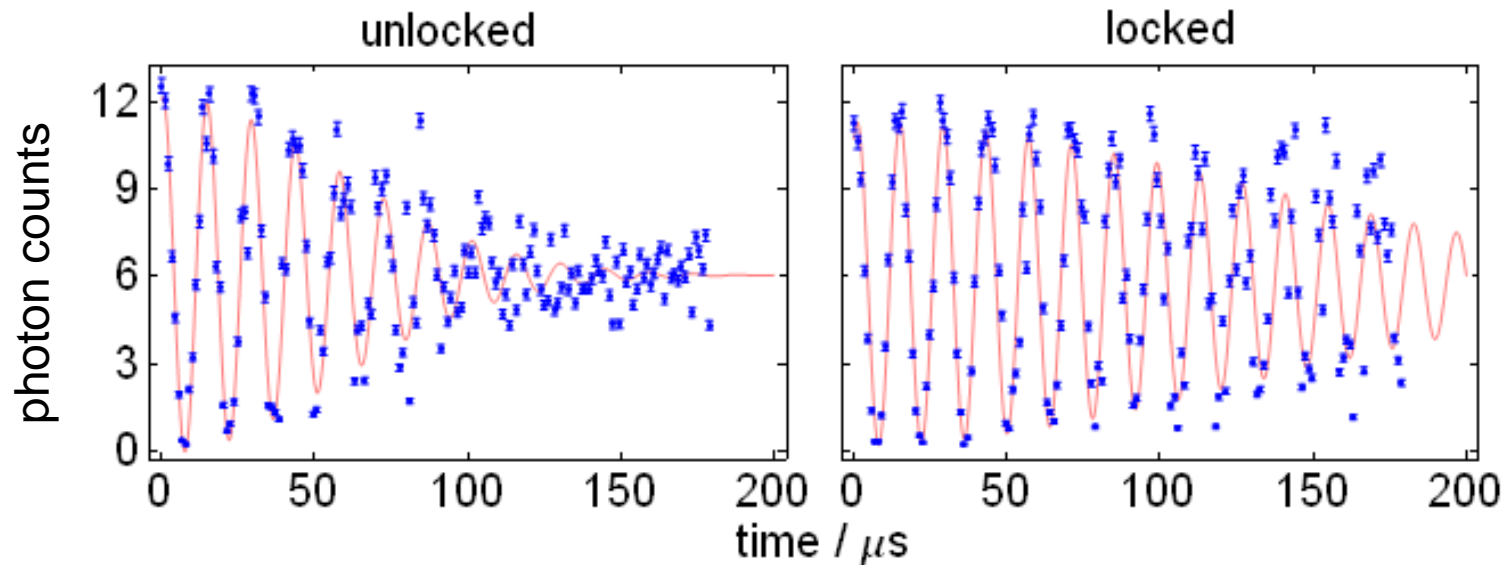

Reduce operation time

One cycle of the arbitrary two-qubit operation experiment:

- 37 ms per run
- 28 single-qubit gates
- 3 two-qubit gates
- 1479 laser pulses
- 2.9 mm distance each qubit moves

- Duty cycle:

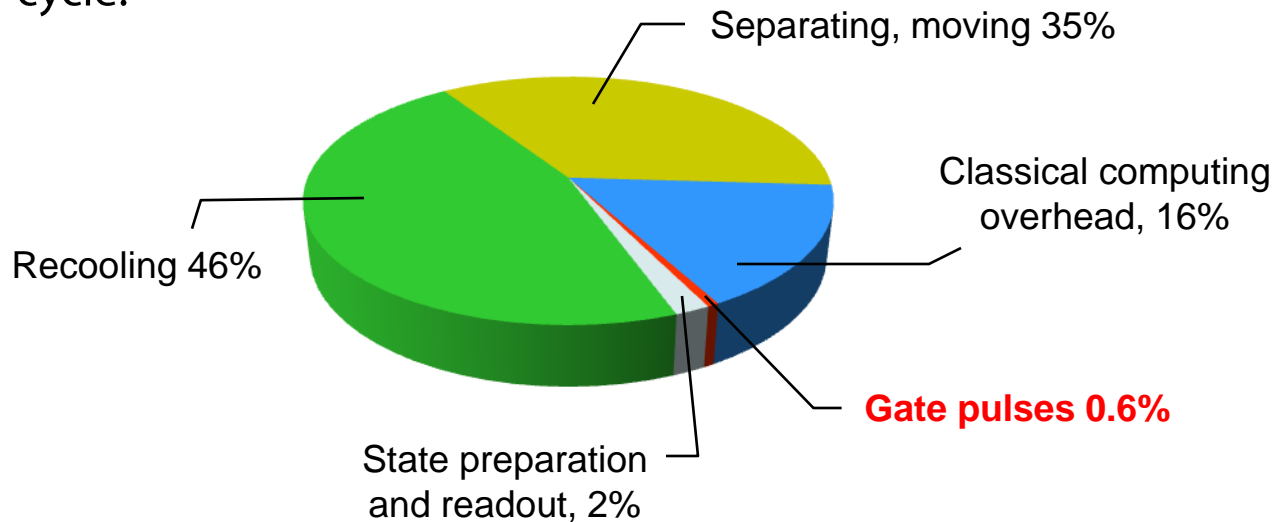

Homemade DACs for more efficient information transport

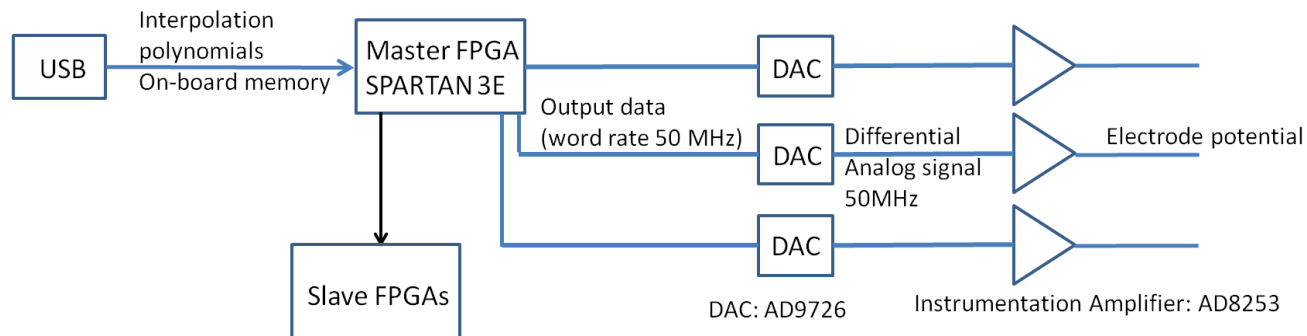

- Faster

- 50 MHz versus 500 kHz
- Speed up transport

- Smoother

- Update rate $\gg \nu_z$
- Less excitation to recool

- Two-ion tests

- Separate & recombine: **< 1 quantum vs ~ 5 quanta**
- Next steps: Test on four ions, optimize fast waveforms

→ 240 μm ←



ions not to scale

Joint state detection of two ions

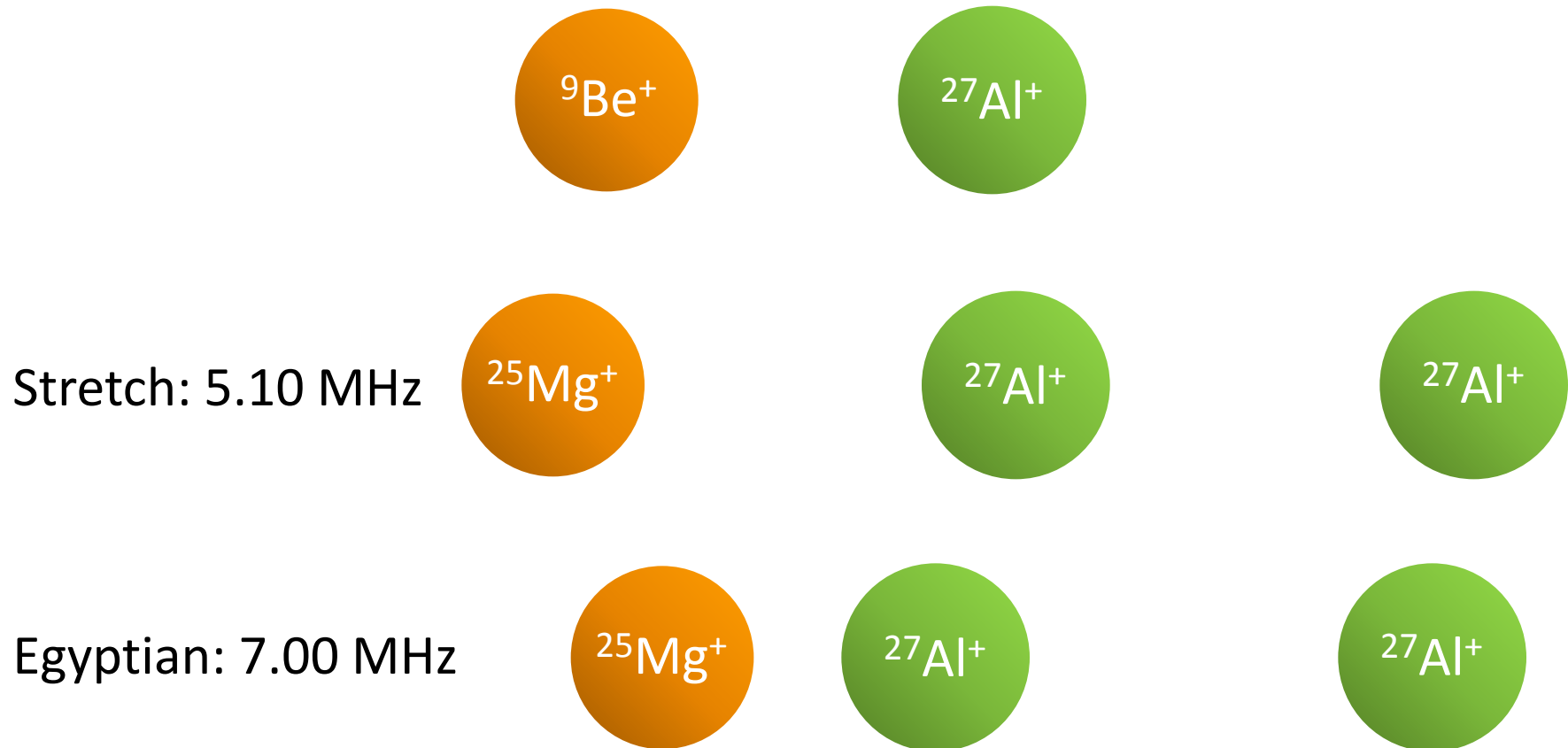

State detection with 99% fidelity after 30 detection cycles

C. W. Chou, D. B. Hume, M. J. Thorpe, D. J. Wineland, and T. Rosenband, arXiv: 1101.3766
see also D. B. Hume *et al.*, PRL **99**, 120502 (2007)

Ring trap

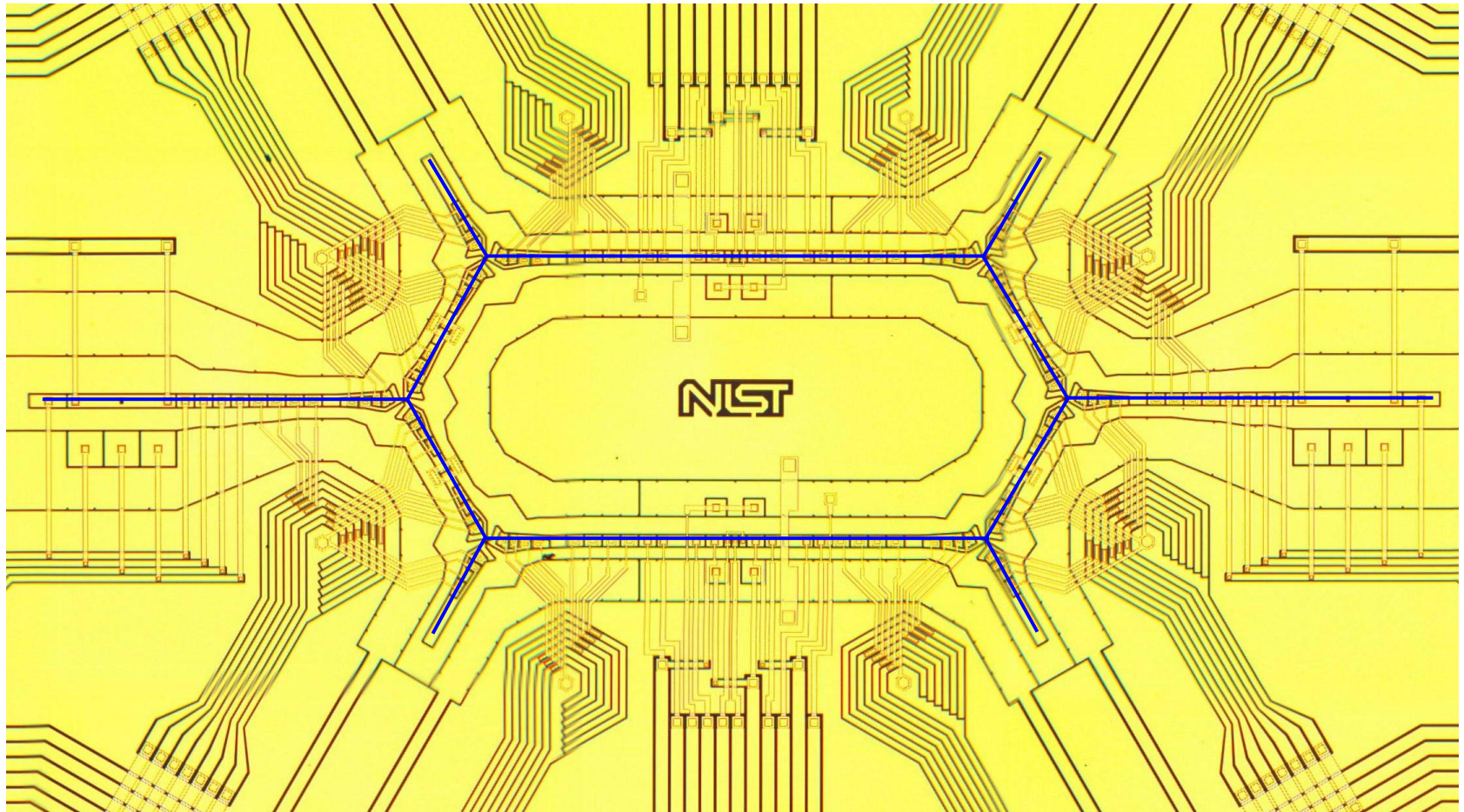

J. M. Amini *et al.*,
New J. Phys. **12**, 033031 (2010)

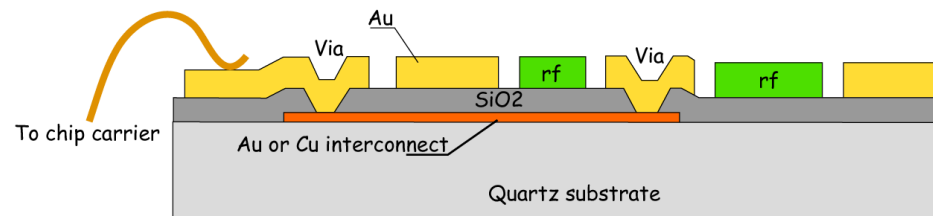

Magnetic gates on a surface trap

Poster #28

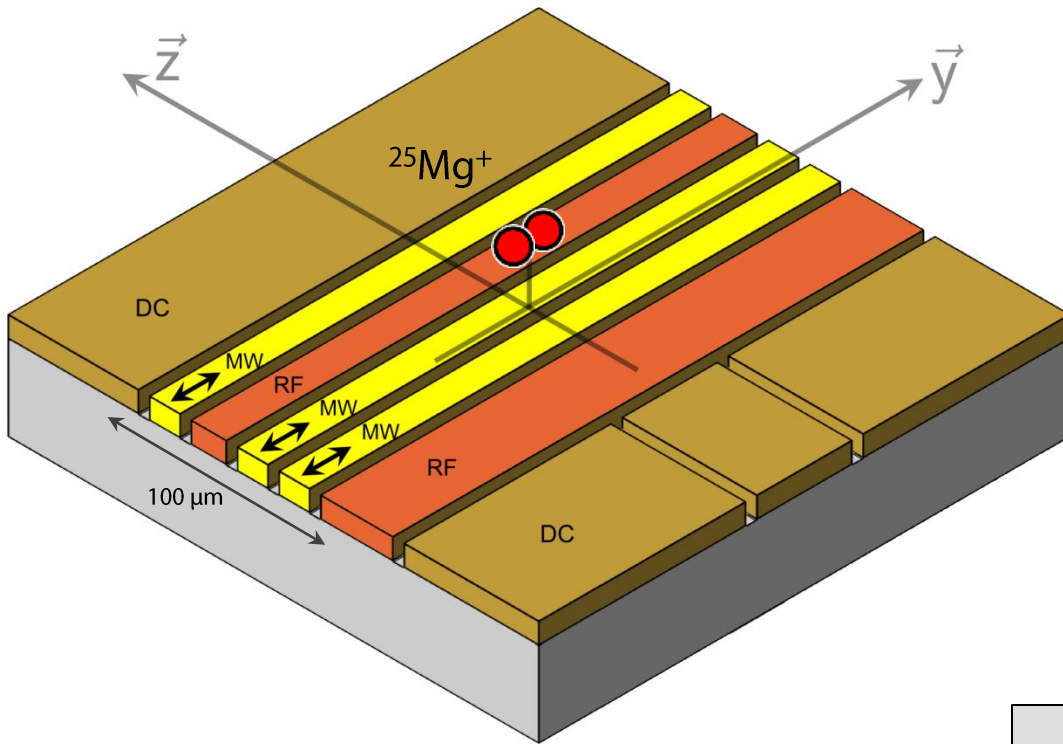

- Fast single qubit rotations, π - time = 18 ns
- Two-qubit gate: work in progress

C. Ospelkaus *et al.*, PRL **101**, 090502 (2008)

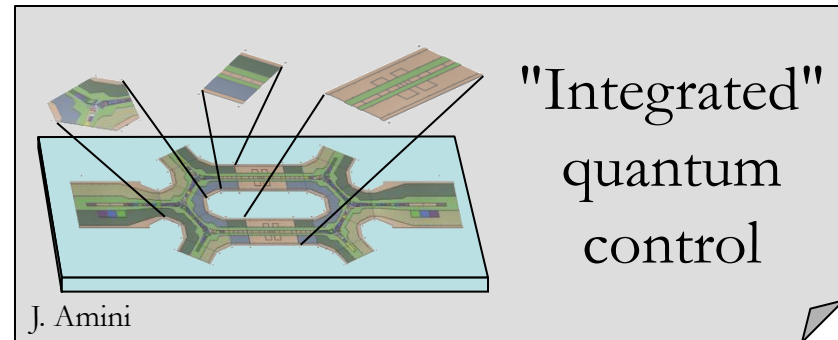
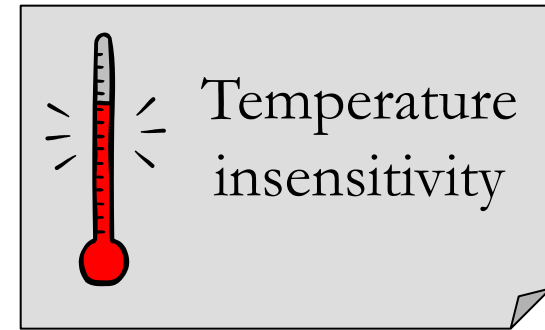
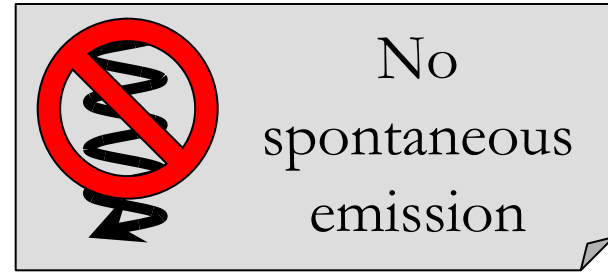

C. Ospelkaus
U. Warring

Nulling the microwave B field

- requirement: B' large, $B = 0$

- with:

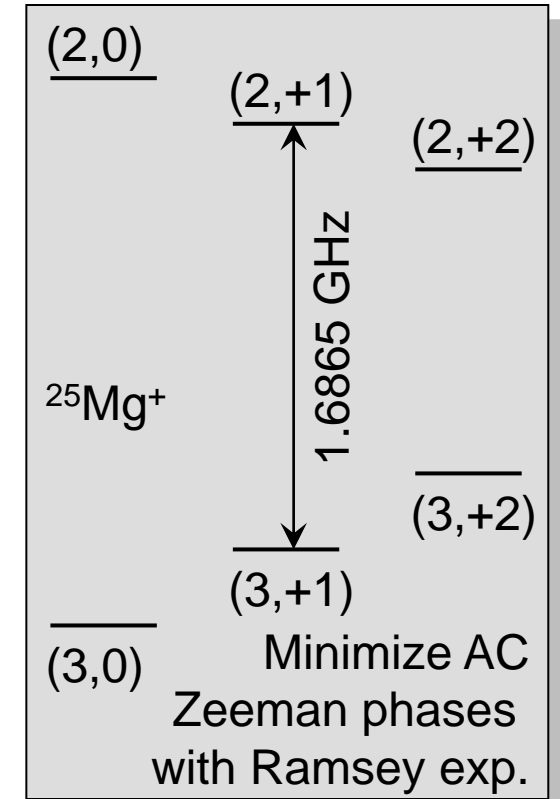
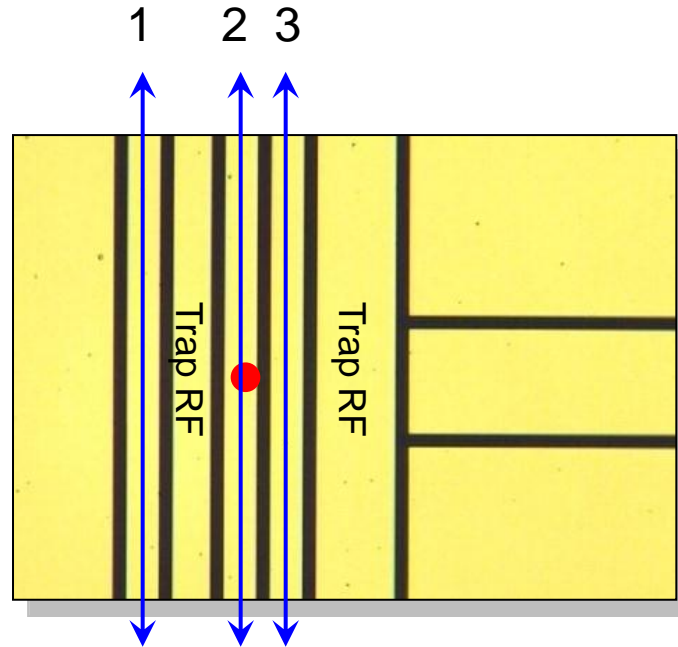

\Rightarrow adjust $I_2, I_3, \varphi_2, \varphi_3$ to achieve $B = 0$ at ion

Sideband cooling on two ions

$^{25}\text{Mg}^+$ field indep. transition

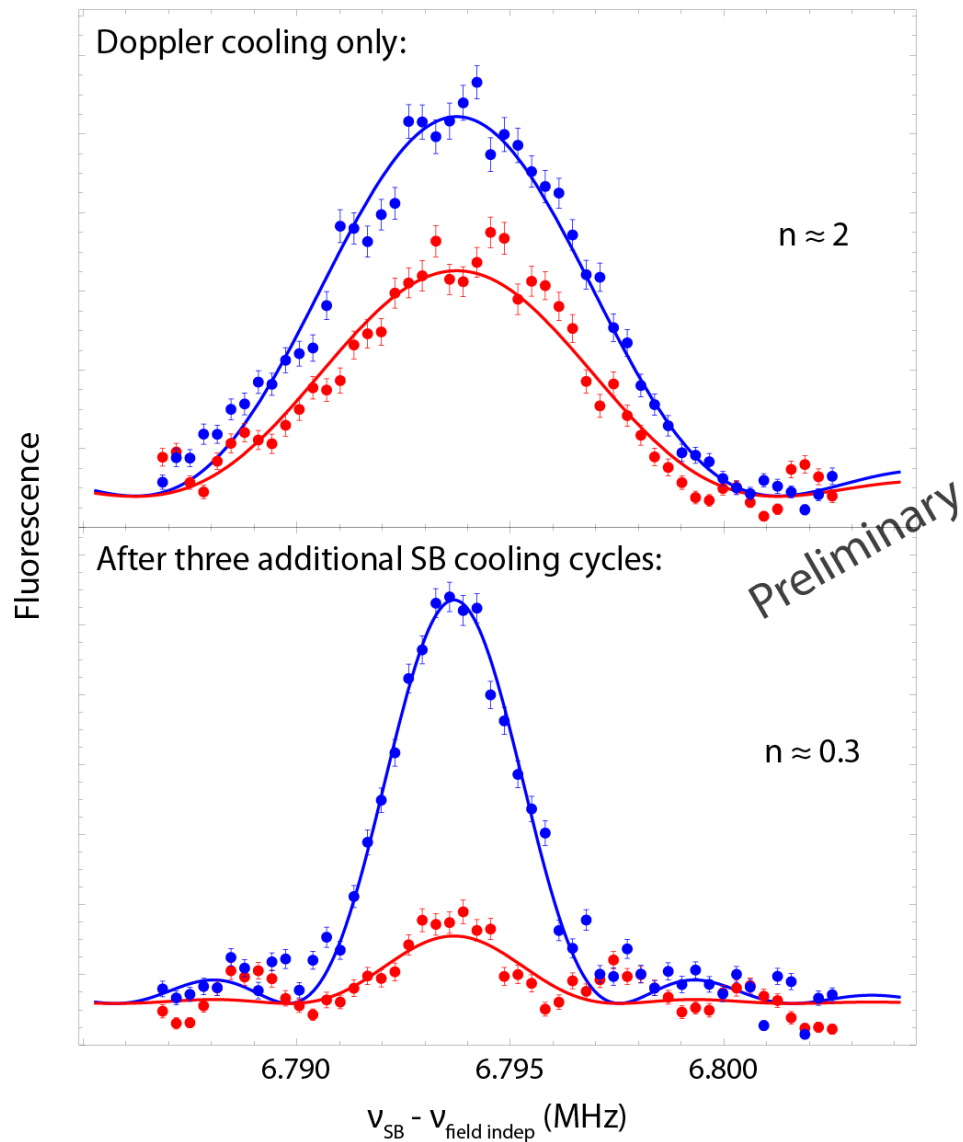
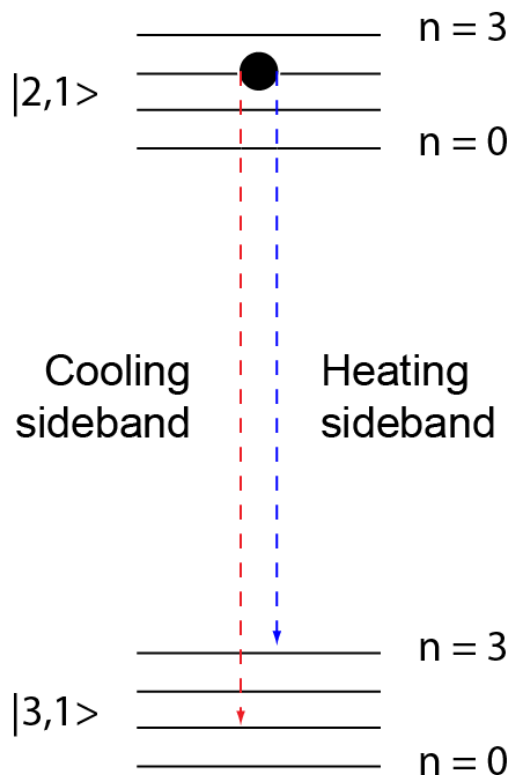

Trap frequency fluctuations

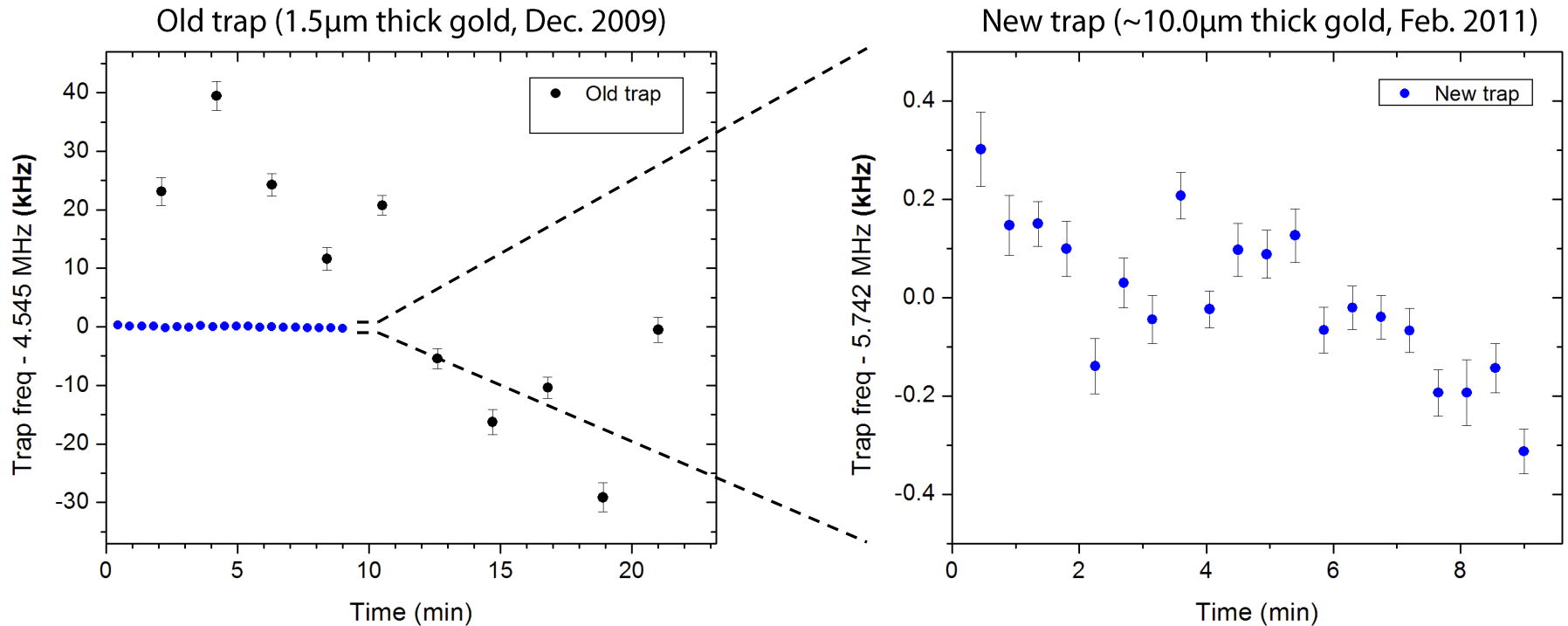

Stability of transverse trap frequency crucial for two-ion gate

- screening of stray charges in the gaps
 - old: **1.5 μm** thick evaporated gold, 5 μm gaps
 - new: **~10.0 μm** thick electroplated gold, 4.5μm gaps
- substrate with higher thermal conductivity
 - old: crystalline quartz (**6 W/m.K**)
 - new: AlN (**270 W/m.K**) ⇒ no more drift during two-ion gate microwave pulse

Dust

Dust on the surface + UV beams:
~ 75 V / 2 mm stray field,
and stray light

⇒ entire fabrication and
trap assembly in cleanroom

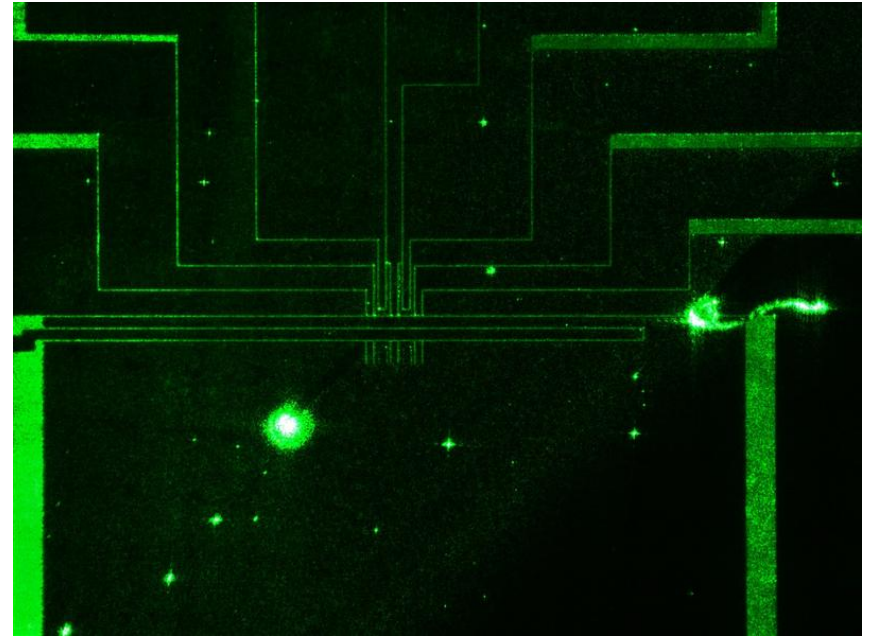

Fiber collection of ion fluorescence

- variable outer RF electrode, 30 – 50 μm trapping height
- $\text{\O}200\ \mu\text{m}$ core, air-clad fiber
NA = 0.64 @700 nm
= 0.37 @280 nm
- home-made polyimide coating
- fiber recessed 50 – 150 μm
- tapered hole drilled
- 50 μm hole FIB'ed from front face by Sandia National Labs 
- 1.5 μm thick evaporated Au on quartz, 5 μm gaps

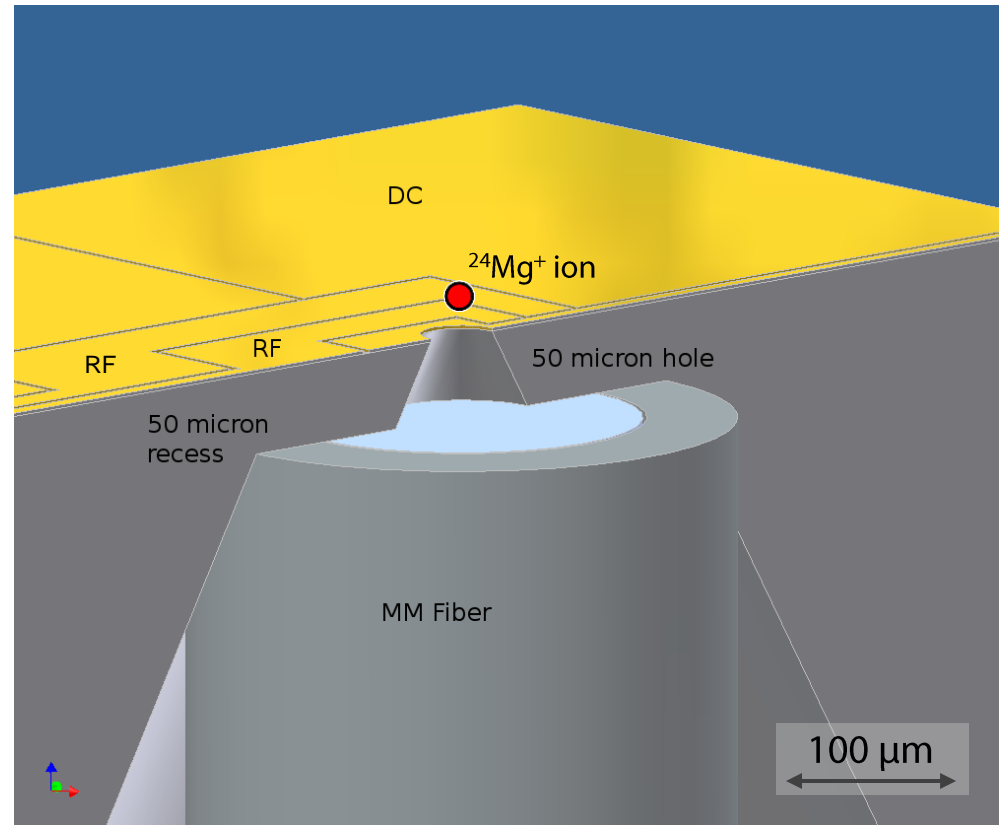

Chip – fibers assembly

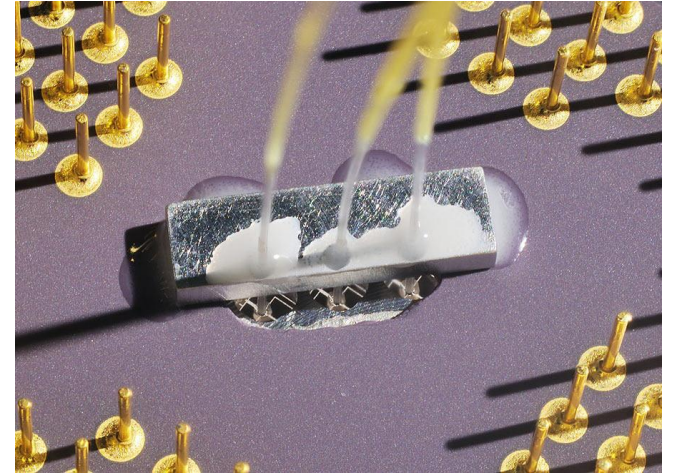
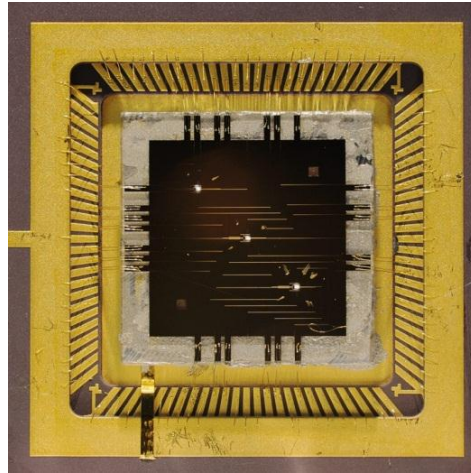
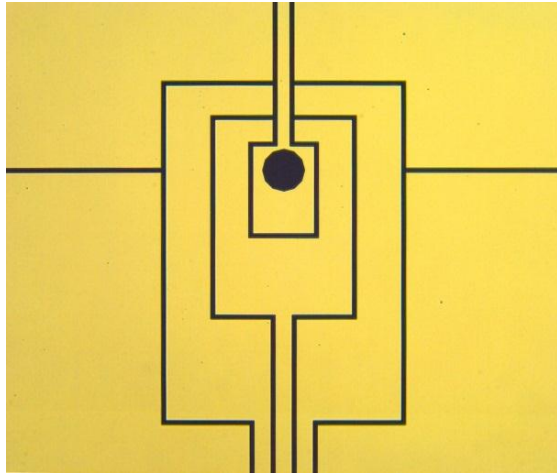

- detection of an ion trapped $30\ \mu\text{m}$ above the surface ($80\ \mu\text{m}$ away from the fiber)
- $\sim 2.1\%$ of emitted photons are channeled to the PMT
- efficiency $0.31\times$ of $\text{NA} = 0.5$ lens, limited by fiber NA

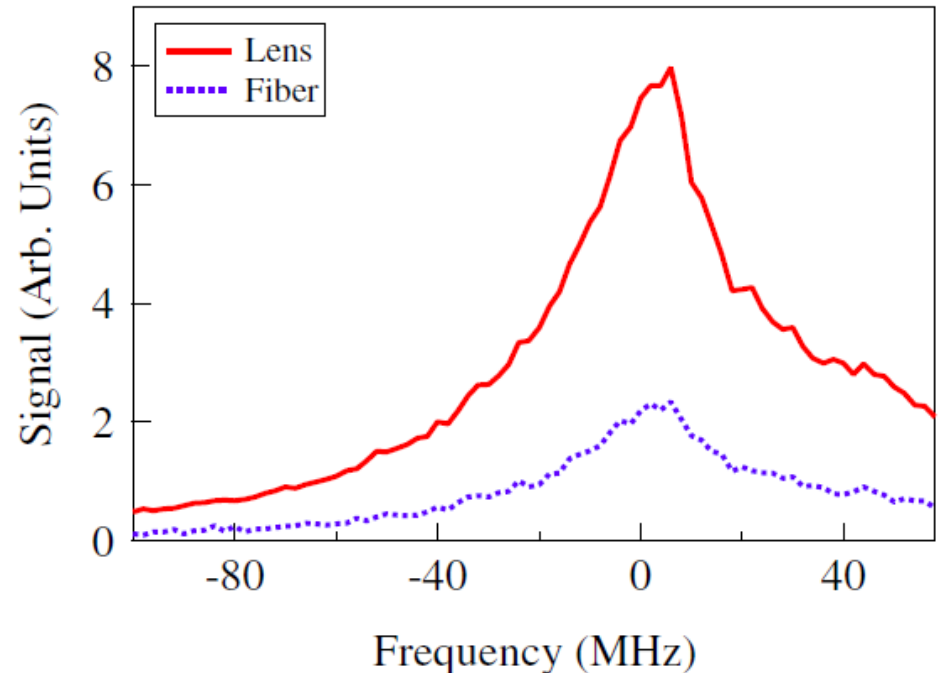

A. P. VanDevender, Y. Colombe, J. Amini, D. Leibfried, and D. J. Wineland, PRL **105**, 023001 (2010)

Chip – fibers assembly

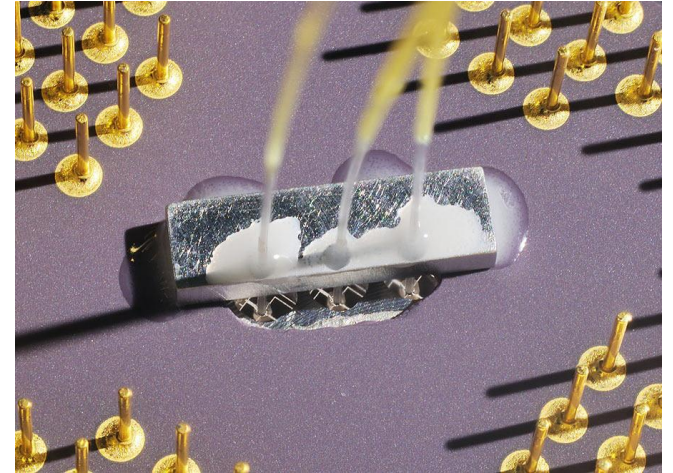
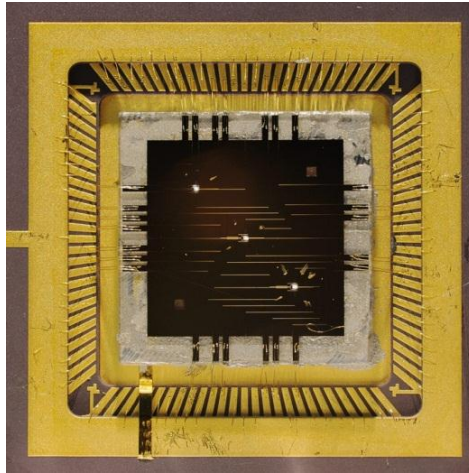
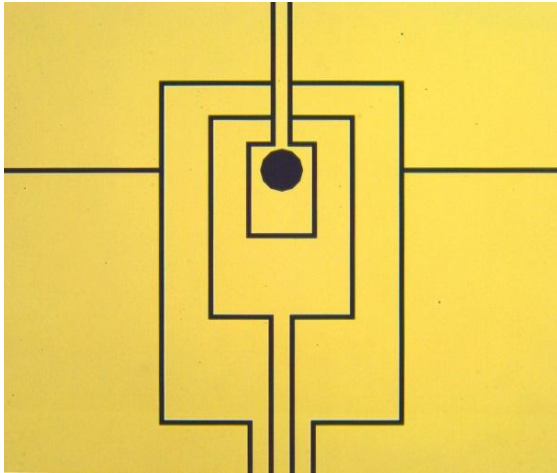

- detection of an ion trapped $30\ \mu\text{m}$ above the surface ($80\ \mu\text{m}$ away from the fiber)
- $\sim 2.1\%$ of emitted photons are channeled to the PMT
- efficiency $0.31\times$ of $\text{NA} = 0.5$ lens, limited by fiber NA
- can be improved by lensing the fiber

A. P. VanDevender, Y. Colombe, J. Amini, D. Leibfried, and D. J. Wineland, PRL **105**, 023001 (2010)

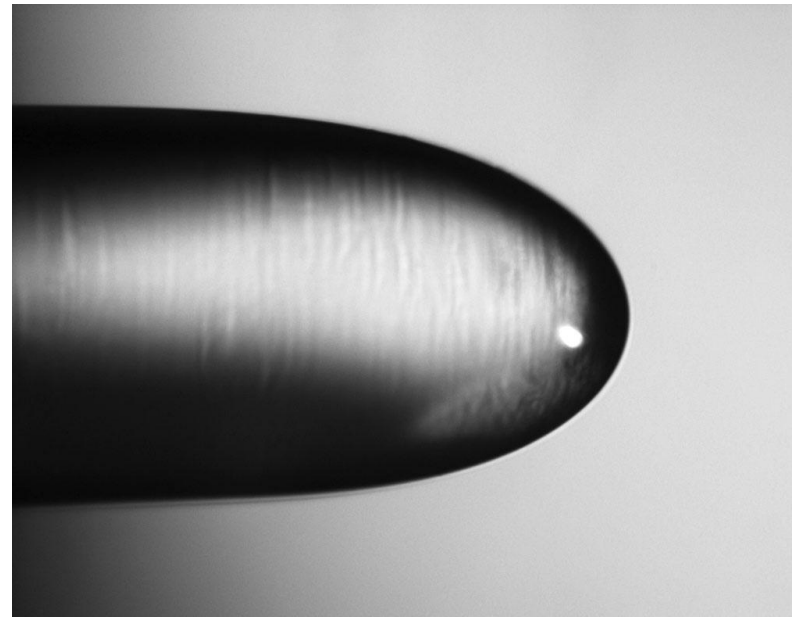

Fiber lensed using a fusion splicer

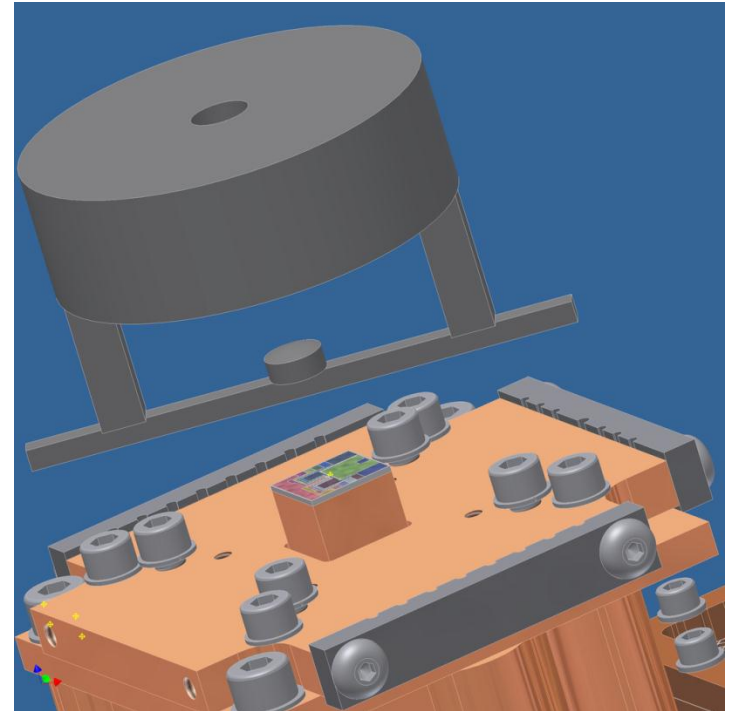
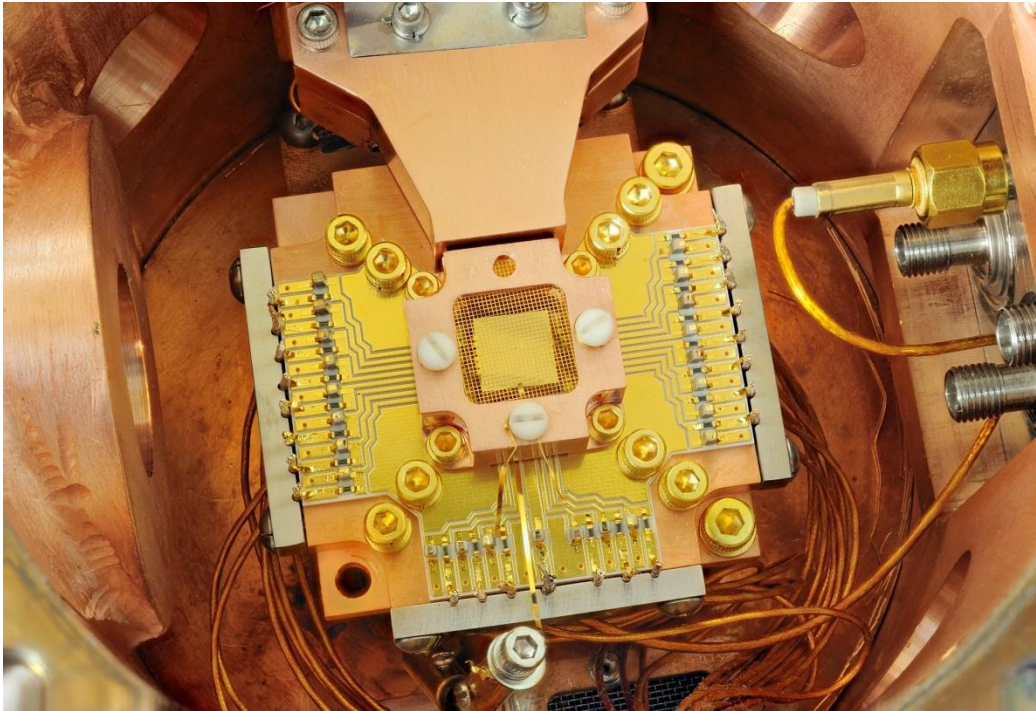

- He bath cryostat 4.2 K
- bakeable pillbox
- Schwarzschild imaging objective to CCD / PMT

K. R. Brown
C. Ospelkaus
Y. Colombe
A. W. Wilson

In-vacuum reflective imaging objective

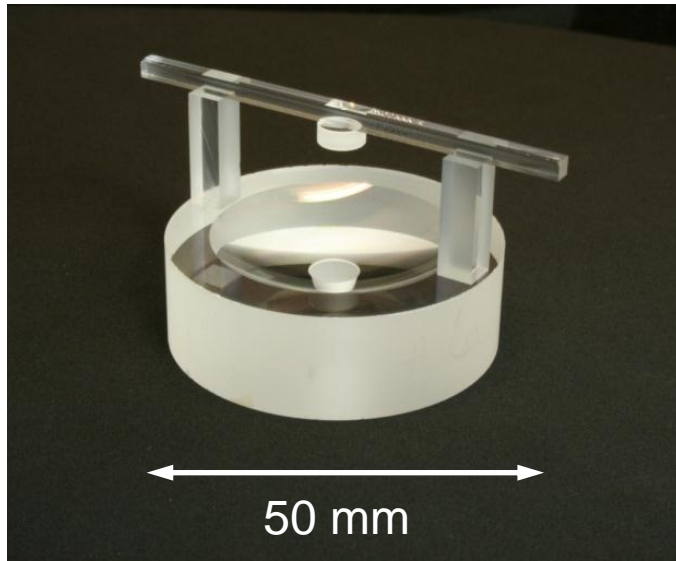

All fused silica, assembled using optical contact and vacuum compatible epoxies

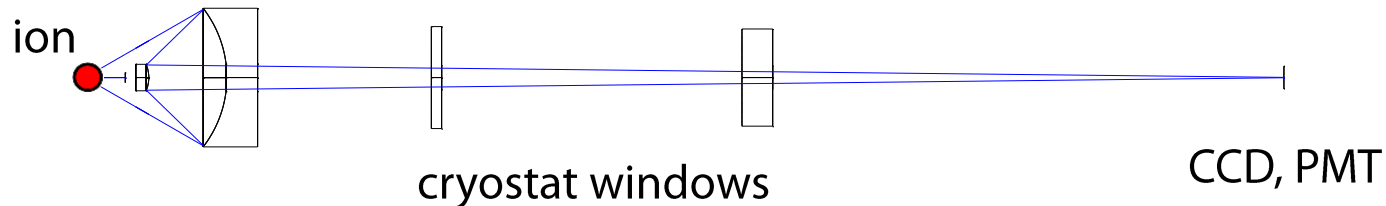

- All-reflective design (protected aluminum surfaces)
- Achromatic: images both P. I. (235 nm) and cooling (313 nm) beams
- In-vacuum, cryogenic and bakeout compatible

Coulomb-coupled ions on a chip

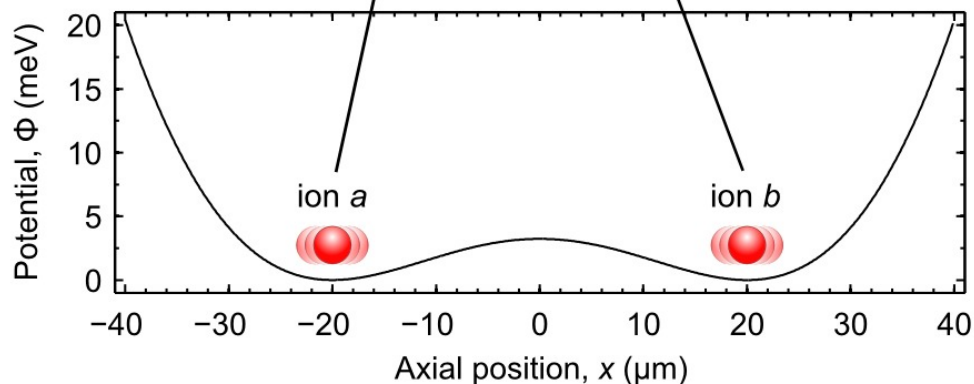
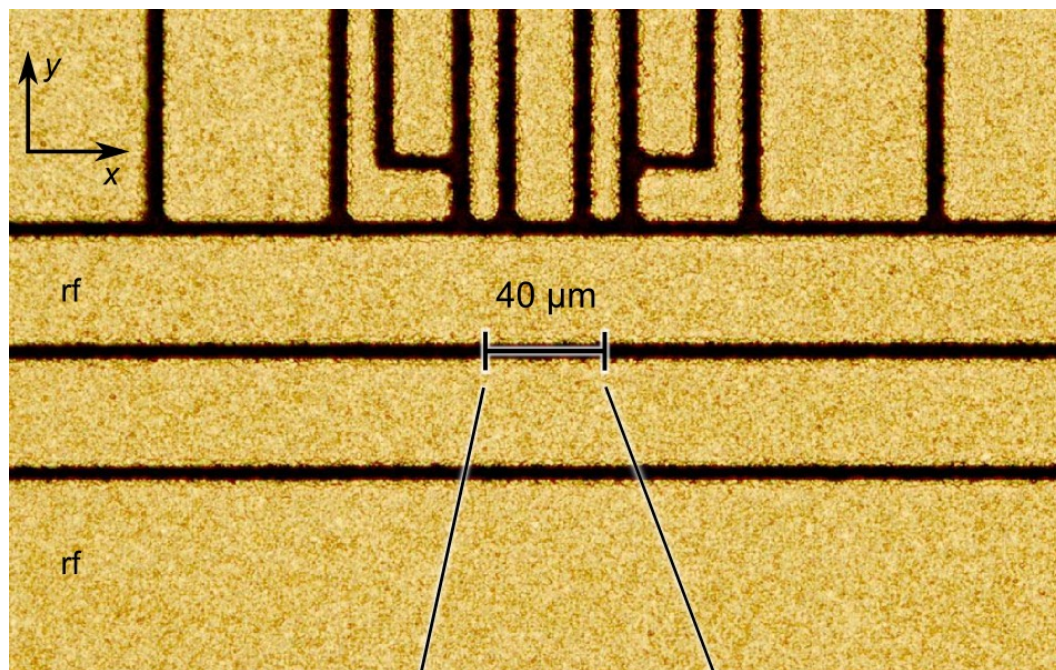

${}^9\text{Be}^+$ ions

$d_0 = 40 \mu\text{m}$ (height of ions)

$\omega_{0x} / 2\pi \sim 4 \text{ MHz}$

$\Omega_{\text{rf}} / 2\pi = 170 \text{ MHz}$

$\omega_{0y,z} / 2\pi \sim 22 \text{ MHz}$

Gold thickness: $8 \mu\text{m}$

Gaps: $5 \mu\text{m}$

Anticrossing of normal modes

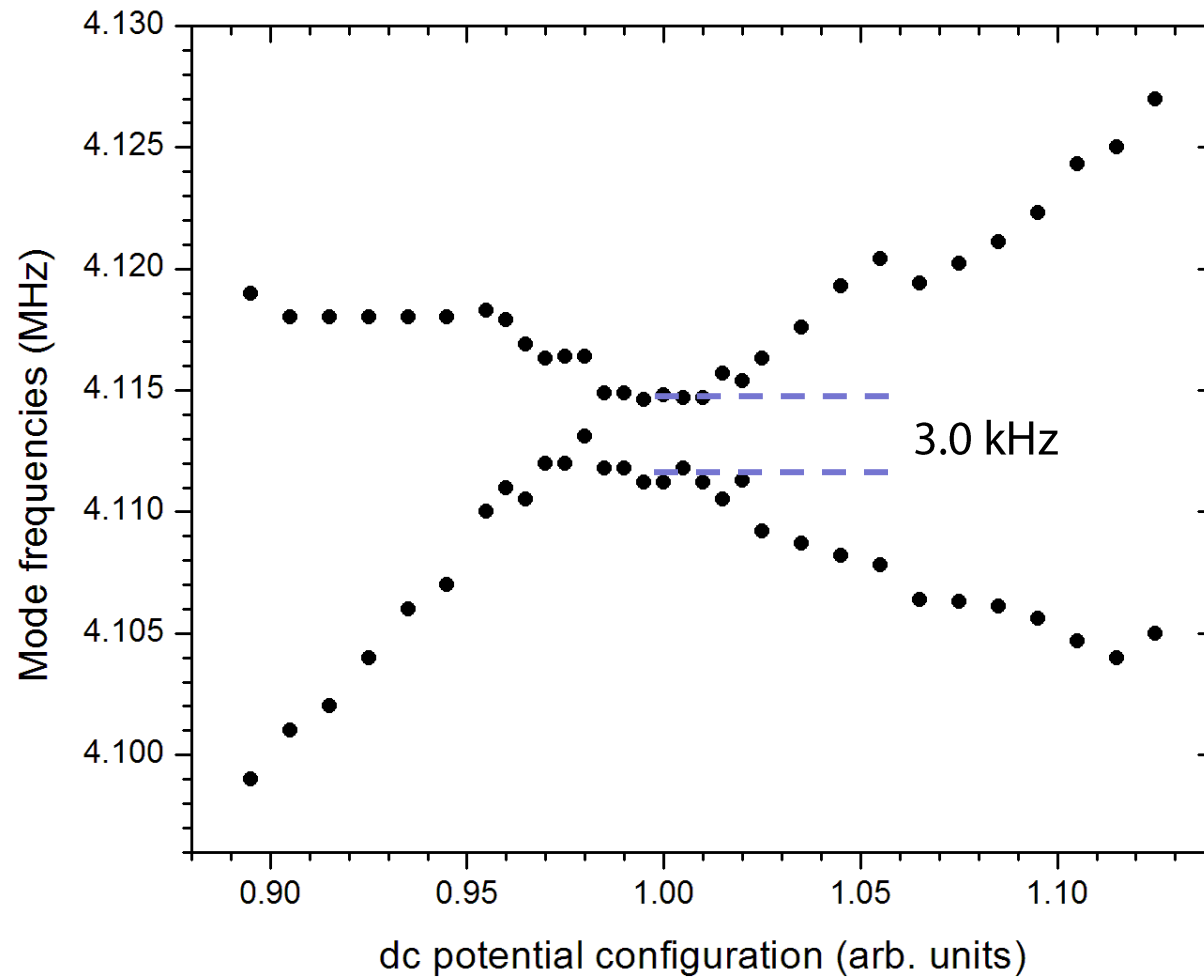

Coupling at the single quantum level

- both ions Doppler cooled
- Raman cooling to $\langle n_a \rangle \sim 0.3$ and $\langle n_b \rangle \leq 0.6$ (sympathetic cooling!)
- blue sideband pulse flips spin and injects phonon
- wait for time τ
- blue sideband pulse conditionally flips spin
- microwave carrier pulse and detection

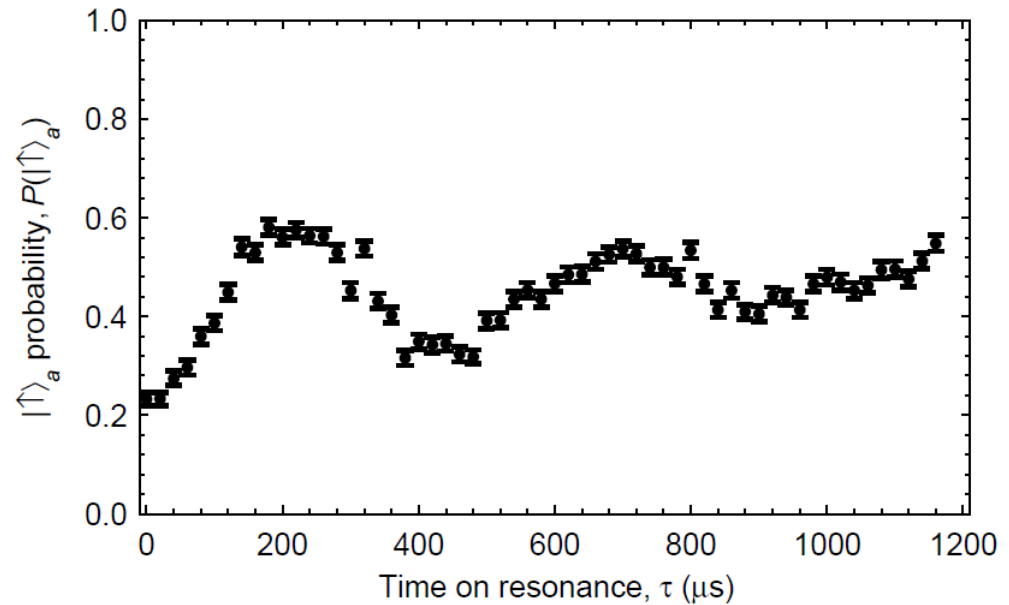

$$2\tau_{\text{ex}} = 437 \mu\text{s} \text{ (} 447 \mu\text{s predicted)}$$
$$(\omega_0 / (2\pi)) = 5.56 \text{ MHz}$$

K.R. Brown *et al.*, arXiv: 1011.0473

related work: Harlander *et al.*, arXiv: 1011.3639

Heating rates

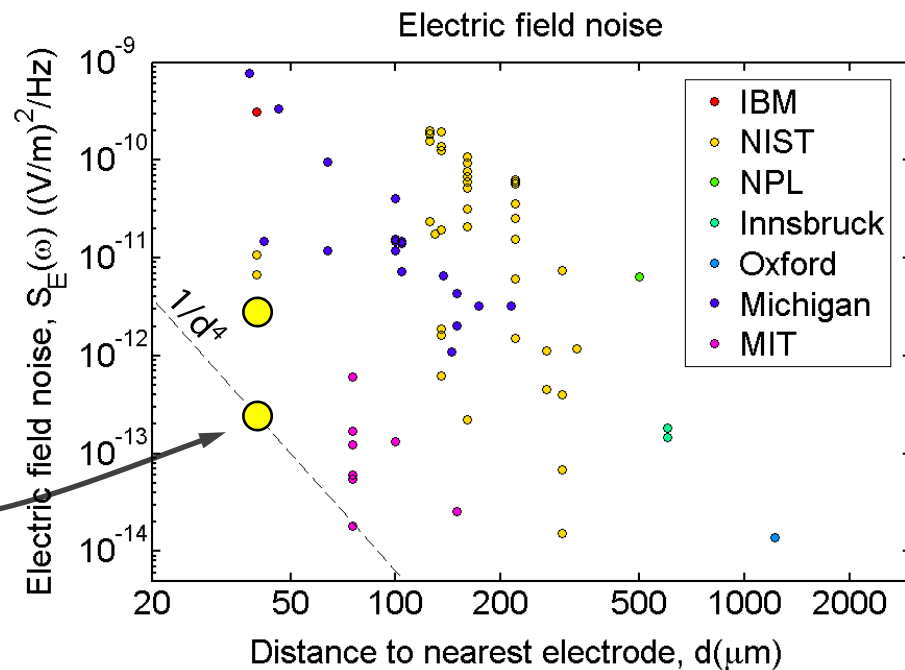
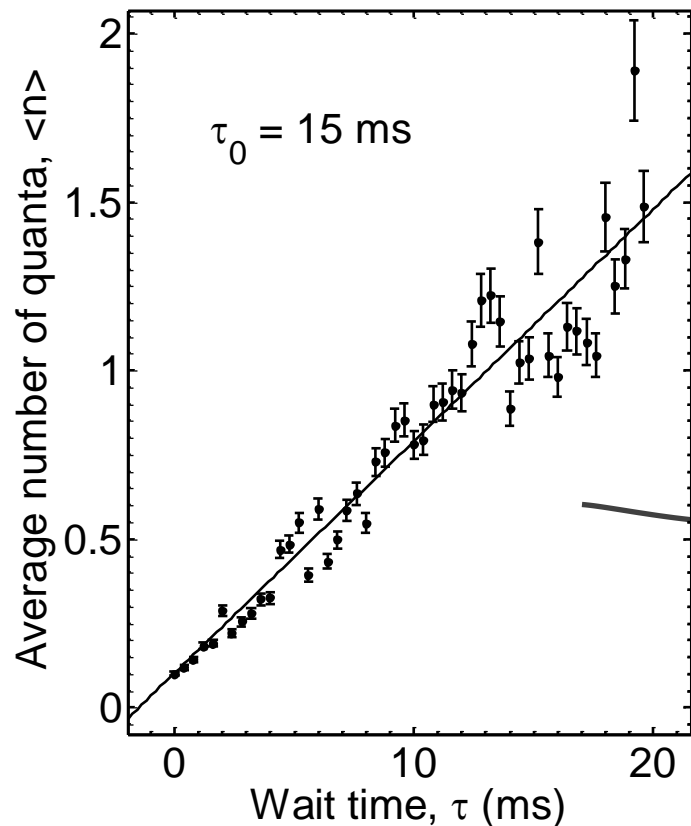

- Low heating rate: 0.07 quantum/ms... observed once!
- Typical heating rates: 0.5 – 2 quanta/ms

Stylus ion trap for surface analysis

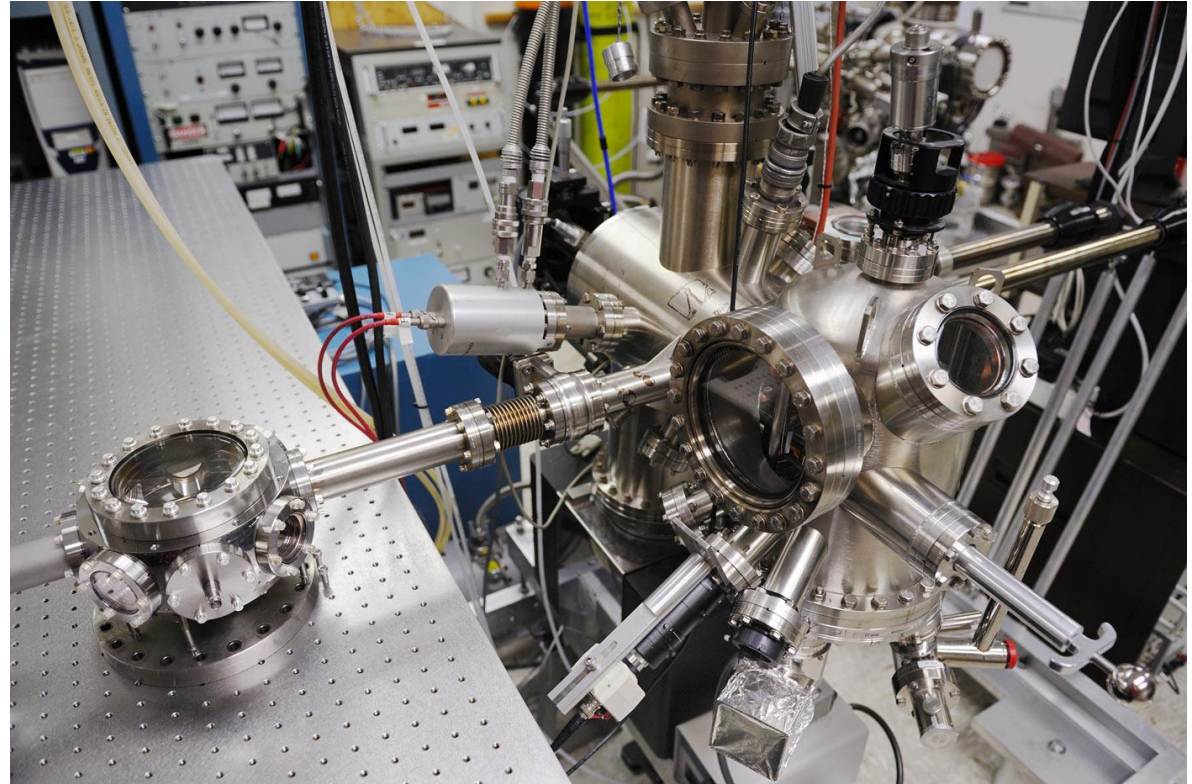
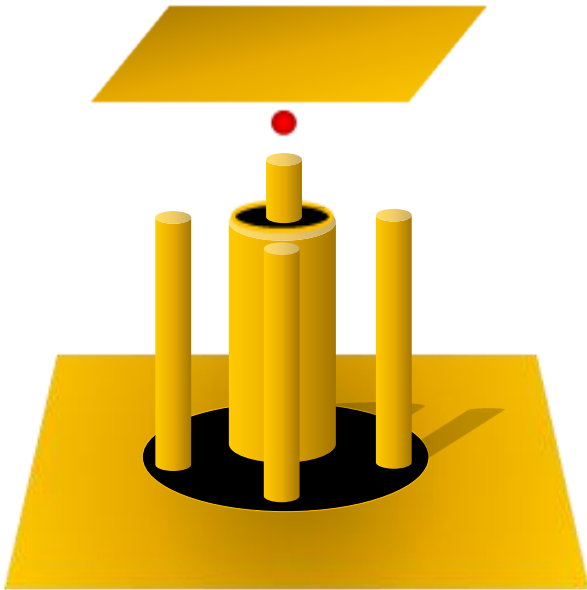

UHV apparatus combining surface analysis tools
and stylus trap ion probe

D. A. Hite
D. P. Pappas

R. Maiwald, D. Leibfried, J. Britton, J. C. Bergquist, G. Leuchs,
and D. J. Wineland, *Nature Physics* **5**, 551 (2009)

Ion trap surface analysis system

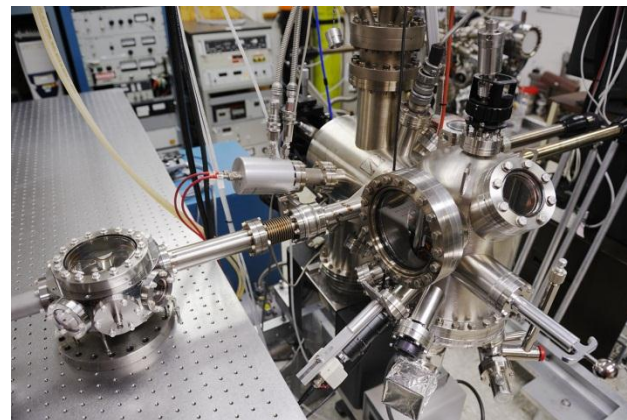
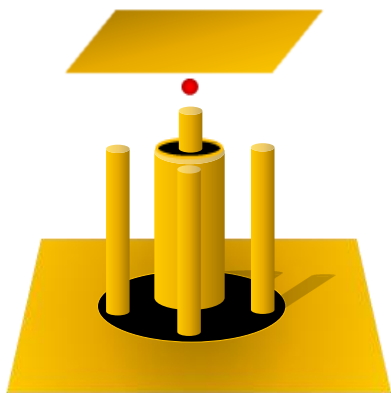
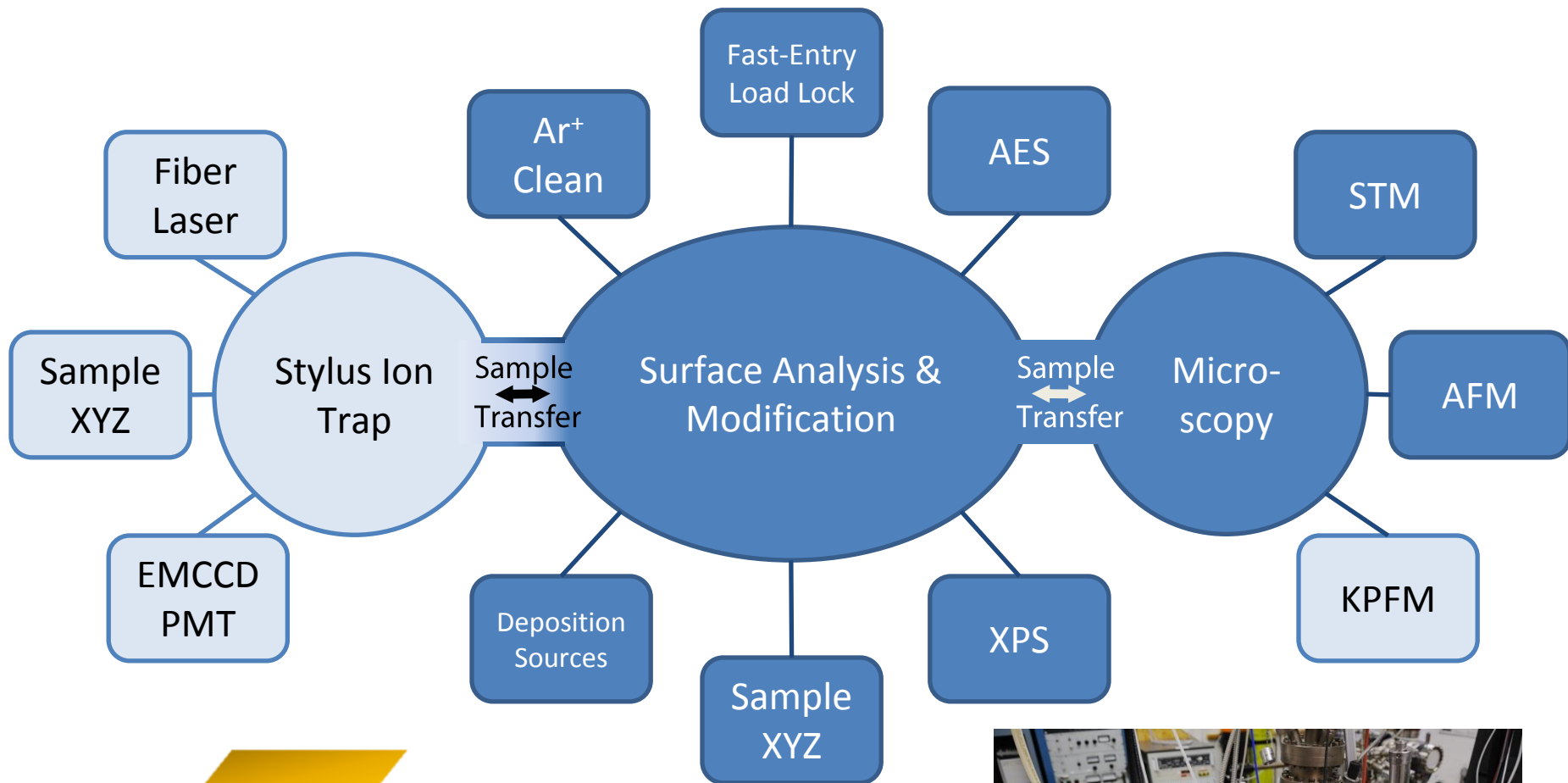

Auger electron spectroscopy of an ion chip

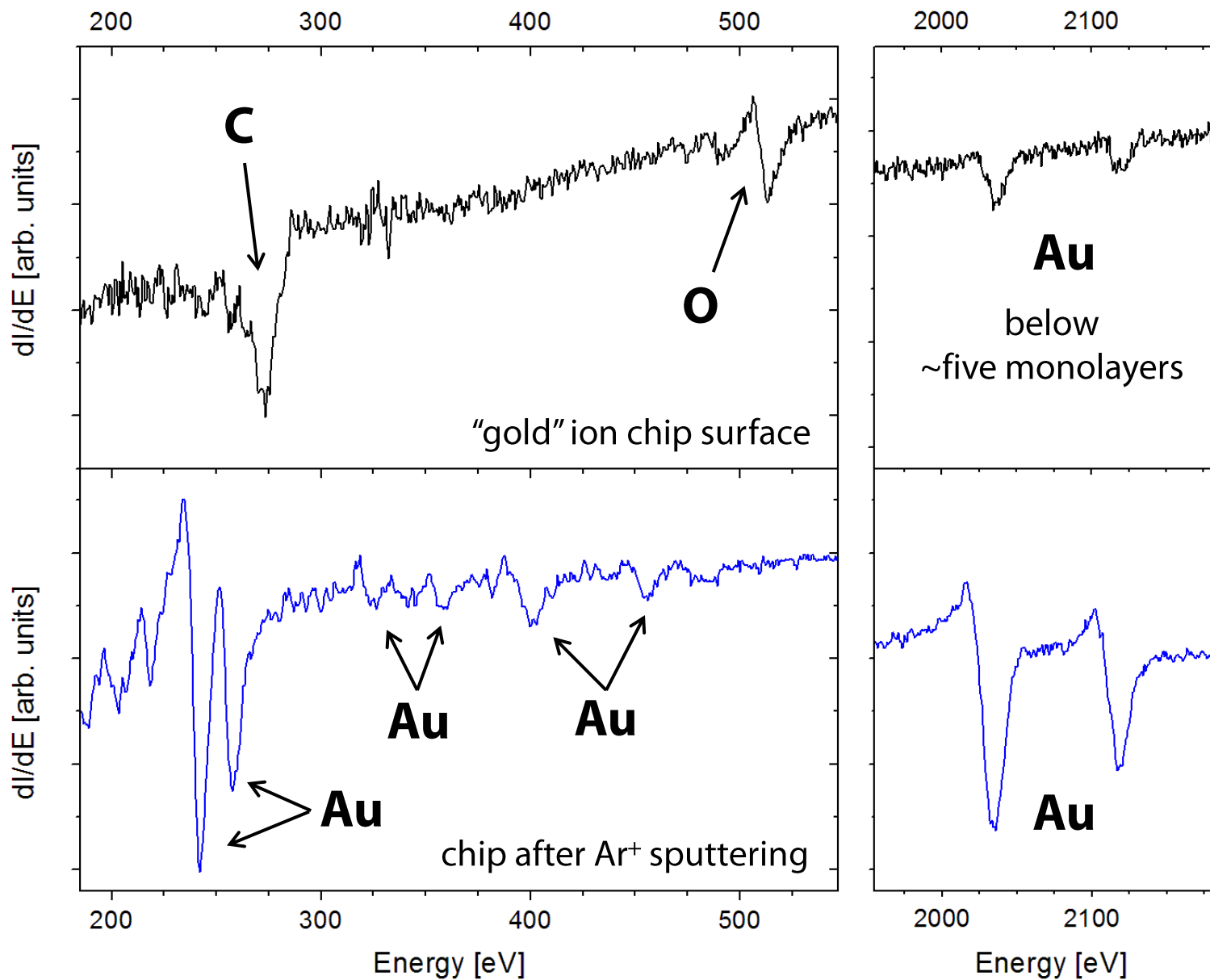

Thank you!

David Wineland
Jim Bergquist
John Bollinger
Wayne Itano
Dietrich Leibfried
Till Rosenband
Manny Knill
Ryan Bowler
Joe Britton
Kenton Brown
James Chou
Yves Colombe
David Hanneke
Dustin Hite
Robert Jördens
John Jost
David Leibbrandt
Yiheng Lin
Brian Sawyer
Ting-Rei Tan
Michael Thorpe
Ulrich Warring
Andrew Wilson



Past members:

Jason Amini (Georgia Tech), Sarah Bickman (Vecent), Mike Biercuk (Sydney), Brad Blakestad (JQI), Jonathan Home (Zurich), David Hume (NIST), Christian Ospelkaus (Hannover), Hermann Uys (Pretoria), Aaron VanDevender