

# Innovative Technology for Computer Professionals

# Computer

NOVEMBER 2012

## The Move Toward Electronic Health Records

<http://www.computer.org>



INVENTING PHP: RASMUS LERDORF, P. 6

VON NEUMANN'S PROGRAMS 65 YEARS LATER, P. 59

CHINA'S INDIGENOUS INNOVATION POLICY, P. 70



# Discover the latest titles in Computer Science from Wiley!

## Information Overload: An International Challenge for Professional Engineers and Technical Communicators

Judith B. Strother, Jan M. Ulijn, Zohra Fazal

9781118230138, Paperback, 320pp,  
\$49.95, October 2012, Wiley-IEEE  
Press

This book covers the ever-increasing problem of information overload from both the professional and academic perspectives. Focusing on the needs of practicing engineers and professional communicators, it addresses the causes and costs of information overload, along with strategies and techniques for reducing and minimizing its negative effects. The theoretical framework of information overload and ideas for future research are also presented. The book brings together an international group of authors, providing a truly global point of view on this important, rarely covered topic.

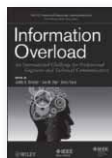

## Reliability and Availability of Cloud Computing

Eric Bauer, Randee Adams

9781118177013, Hardcover, 352pp,  
\$79.95, August 2012, Wiley-IEEE Press

This book addresses IS/IT architects, developers, program managers, product managers, and quality managers who are considering or responsible for applications that will be virtualized or deployed on a cloud. Topics covered include reliability risks, meeting customer's expectations, and how to maximize service availability and reliability of virtualized and cloud-based deployments. Working from first principles, this book considers the impact on virtualization and cloud computing in terms of both what design for reliability diligence is most appropriate, and how best to leverage virtualization and cloud to best assure market expectations.



## Energy Efficient Distributed Computing Systems

Albert Y. Zomaya, Young Choon Lee

9780470908754, Hardcover, 856pp,  
\$130, August 2012, Wiley-IEEE  
Computer Society Press

One of the first books of its kind, this timely reference illustrates the need for and the state of increasingly energy efficient distributed computing systems. Featuring the latest research findings on emerging topics by well-known scientists, it explains how constraints on energy consumption creates a suite of complex engineering problems that need to be resolved in order to lead to greener distributed computing systems. Practitioners, postgraduate students, postdocs, researchers, engineers and scientists working in high-performance computing areas will find the insights in this work invaluable.

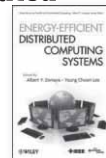

## The Death of the Internet

Markus Jakobsson

9781118062418, Paperback, 392pp,  
\$69.95, July 2012, Wiley-IEEE  
Computer Society Press

Covering internet security, malware, phishing, and how to combat these serious and growing issues on both desktop and smart phone platforms, this book draws upon state-of-the-art research from industry and academia. The content also describes proven countermeasures using real world examples. Filled with accessible and informative coverage, this resource will prove essential for students, professionals, and large corporations.

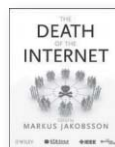

## Practical Database Programming with Visual Basic.NET, 2nd Edition

Ying Bai

9781118162057, Paperback, 896pp,  
\$99.95, June 2012, Wiley-IEEE Press

Unlike most database programming books, which overwhelm readers with large amount of code, this book employs a new, more reader-friendly approach. Now in a new edition updated with the latest tools and information, it lays out to readers, in particular college students, how to develop professional and practical database programs in Visual Basic.NET environment by using Visual Studio.NET Data Tools and Wizards related to ADO.NET 4.0. This new approach allows readers to learn simpler ways of database programming, and enables students to build professional and practical database programming with greater efficiency.

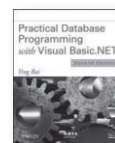

## Advanced Internet Protocols, Services, and Applications

Eiji Oki, Roberto Rojas-Cessa,  
Mallikarjun Tatipamula, Christian Vogt

9780470499030, Hardcover, 260pp,  
\$99.95, April 2012, Wiley

This book offers a comprehensive technical overview and survey of advanced internet protocols, first providing a solid introduction and going on to discuss internetworking technologies, architectures, and protocols. It shows application of the concepts in next generation networks and discusses protection and restoration, as well as various tunneling protocols and applications. It also informs readers of applicability of protocols in emerging technologies, such as wireless and optical. R&D managers, software and hardware engineers, system engineers, and telecommunication/networking professionals will find this reference indispensable.



## Cyber Security Policy Guidebook

Jennifer L. Bayuk, Jason Healey, Paul Rohmeyer, Marcus H. Sachs, Jeffrey Schmidt, Joseph Weiss

9781118027806, Hardcover, 288pp,  
\$89.95, April 2012, Wiley

Drawing upon a wealth of experience from academia, industry, and government service, *Cyber Security Policy Guidebook* details and dissects, in simple language, current organizational cyber security policy issues on a global scale--taking great care to educate readers on the history and current approaches to the security of cyberspace. It includes thorough descriptions--as well as the pros and cons--of a plethora of issues, and documents policy alternatives for the sake of clarity with respect to policy alone.



## Computer, Network, Software, and Hardware Engineering with Applications

Norman F. Schneidewind

9781118037454, Hardcover, 608pp,  
\$135, March 2012, Wiley-IEEE Press

Today's computer-based systems are highly complex because they are comprised of network, software, and hardware components. In addition to basic design considerations, the system design must include reliability, availability, and maintainability of hardware and software. Written to assist practicing engineers, advanced undergraduate students, and graduate students in designing networks, software, and hardware, this book addresses all of these topics in an integrated fashion.



## Enterprise Software Architecture and Design: Entities, Services, and Resources

Dominic Duggan

9780470565452, Hardcover, 512pp,  
\$120, February 2012, Wiley-IEEE  
Computer Society Press

Providing guidelines and best practices for the use and applications of SOA, this book covers the general implications of SOA, from low-level basic service design to the broader field of service composition and process oriented SOA. It features synergy of low-level technical and high-level systems engineering perspectives; examples in Java Enterprise Edition and Windows Concurrency Framework; and emphasizes available tools such as Glassfish, EMF and YAWL that students can use for hands-on experimentation. It is intended as a textbook for students in computer science, information systems, and systems engineering.



Content YOU Need.  
Wherever YOU Are. Instantly



Many Wiley titles are available digitally for download onto your computer, laptop or mobile device.

Visit [www.wiley.com](http://www.wiley.com) for details.

Enter promotion code **COM12** to receive **20% off** these featured titles at checkout.

ORDER INFORMATION 1 (877) 762-2974 North America • + 44 (0) 1243 843294 in Rest of World • Log on to [www.wiley.com/IEEE](http://www.wiley.com/IEEE)

**WILEY**  
IEEE  
computer  
Society  
**IEEE**

# Innovative Technology for Computer Professionals

# Computer

**Editor in Chief**

**Ron Vetter**  
University of North Carolina  
Wilmington  
vetterr@uncw.edu

**Associate Editor in Chief**

**Sumi Helal**  
University of Florida  
helal@cise.ufl.edu

**Associate Editor in Chief, Research Features**

**Kathleen Swigger**  
University of North Texas  
kathy@cs.unt.edu

**Associate Editor in Chief, Special Issues**

**Bill N. Schilit**  
Google  
schilit@computer.org

**Computing Practices**

**Rohit Kapur**  
Synopsys  
rohit.kapur@synopsys.com

**Perspectives**

**Bob Colwell**  
bob.colwell@comcast.net

**Multimedia Editor**

**Charles R. Severance**  
csev@umich.edu

**2012 IEEE Computer Society President**

**John W. Walz**  
johnwalz@ameritech.net

**Area Editors****Computer Architectures**

**David H. Albonese**

Cornell University

**Tom Conte**

Georgia Tech

**Steven K. Reinhardt**

AMD

**Greg Byrd**

North Carolina State University

**Graphics and Multimedia**

**Oliver Bimber**

Johannes Kepler University Linz

**High-Performance Computing**

**Vladimir Getov**

University of Westminster

**Information and Data Management**

**Naren Ramakrishnan**

Virginia Tech

**Internet Computing**

**Simon Shim**

San Jose State University

**Multimedia**

**Savitha Srinivasan**

IBM Almaden Research Center

**Networking**

**Ahmed Helmy**

University of Florida

**Ying-Dar Lin**

National Chiao Tung University

**Security and Privacy**

**Rolf Oppliger**

eSECURITY Technologies

**Software**

**Renée Bryce**

University of North Texas

**Robert B. France**

Colorado State University

**Jean-Marc Jézéquel**

University of Rennes

**David M. Weiss**

Iowa State University

**Column Editors****Computing Conversations**

**Charles R. Severance**

University of Michigan

**Discovery Analytics**

**Naren Ramakrishnan**

Virginia Tech

**Education**

**Ann E.K. Sobel**

Miami University

**Entertainment Computing**

**Kelvin Sung**

University of Washington, Bothell

**Forward Slash**

**David A. Grier**

George Washington University

**Green IT**

**Kirk W. Cameron**

Virginia Tech

**Identity Sciences**

**Karl Ricanek**

University of North Carolina,

Wilmington

**In Development**

**Chris Huntley**

Fairfield University

**Invisible Computing**

**Albrecht Schmidt**

University of Stuttgart

**Out of Band**

**Hal Berghel**

University of Nevada, Las Vegas

**Security**

**Jeffrey M. Voas**

NIST

**Social Computing**

**John Riedl**

University of Minnesota

**Software Technologies**

**Mike Hinchey**

Lero—the Irish Software

Engineering Research Centre

**32 & 16 Years Ago**

**Neville Holmes**

University of Tasmania

**Advisory Panel**

**Carl K. Chang**

Editor in Chief Emeritus

Iowa State University

**Jean Bacon**

University of Cambridge

**Hal Berghel**

University of Nevada, Las Vegas

**Doris L. Carver**

Louisiana State University

**Rick Mathieu**

James Madison University

**Naren Ramakrishnan**

Virginia Tech

**Theresa-Marie Rhyne**

Consultant

**Alf Weaver**

University of Virginia

**Publications Board**

**Thomas M. Conte** (chair),  
**Alain April**, **David Bader**,  
**Angela R. Burgess**, **Greg**  
**Byrd**, **Jim Cortada**,  
**Koen De Bosschere**, **Hakan**  
**Erdogmus**, **Frank E. Ferrante**,  
**Jean-Luc Gaudiot**, **Linda I.**  
**Shafer**, **Per Stenström**,  
**George Thiruvathukal**

**Magazine Operations Committee**

**Jean-Luc Gaudiot** (chair),  
**Erik R. Altman**, **Isabel Beichl**,  
**Nigel Davies**, **Lars Heide**,  
**Simon Liu**, **Dejan Milojicic**,  
**Michael Rabinovich**,  
**Forrest Shull**, **John Smith**,  
**Gabriel Taubin**, **Ron Vetter**,  
**John Viega**, **Fei-Yue Wang**

**Editorial Staff**

**Judith Prow**

Managing Editor

jpro@computer.org

**Chris Nelson**

Senior Editor

**Contributing Editors**

**Camber Agrelius**

**Christine Anthony**

**Lee Garber**

**Bob Ward**

**Staff Multimedia**

**Editors**

**Brian Brannon**

**Ben Jones**

**Design and Production**

**Larry Bauer**

**Design**

**Olga D'Astoli**

**Cover Design**

**Kate Wojogbe**

**Jennie Zhu**

**Administrative Staff**

**Products and**

**Services Director**

**Evan Butterfield**

**Senior Manager,**

**Editorial Services**

**Lars Jentsch**

**Manager, Editorial Services**

**Jennifer Stout**

**Senior Business**

**Development Manager**

**Sandy Brown**

**Senior Advertising**

**Coordinator**

**Marian Anderson**

**Circulation:** *Computer* (ISSN 0018-9162) is published monthly by the IEEE Computer Society. **IEEE Headquarters**, Three Park Avenue, 17th Floor, New York, NY 10016-5997; **IEEE Computer Society Publications Office**, 10662 Los Vaqueros Circle, Los Alamitos, CA 90720-1314; voice +1 714 821 8380; fax +1 714 821 4010; **IEEE Computer Society Headquarters**, 2001 L Street NW, Suite 700, Washington, DC 20036. IEEE Computer Society membership includes \$19 for a subscription to *Computer* magazine. Nonmember subscription rate available upon request. Single-copy prices: members \$20; nonmembers \$99.

**Postmaster:** Send undelivered copies and address changes to *Computer*, IEEE Membership Processing Dept., 445 Hoes Lane, Piscataway, NJ 08855. Periodicals Postage Paid at New York, New York, and at additional mailing offices. Canadian GST #125634188. Canada Post Corporation (Canadian distribution) publications mail agreement number 40013885. Return undeliverable Canadian addresses to PO Box 122, Niagara Falls, ON L2E 6S8 Canada. Printed in USA.

**Editorial:** Unless otherwise stated, bylined articles, as well as product and service descriptions, reflect the author's or firm's opinion. Inclusion in *Computer* does not necessarily constitute endorsement by the IEEE or the Computer Society. All submissions are subject to editing for style, clarity, and space.

# Innovative Technology for Computer Professionals

# Computer

[www.computer.org/computer](http://www.computer.org/computer)

CONTENTS



## COVER FEATURES

### 22 GUEST EDITOR'S INTRODUCTION

### The Move Toward Electronic Health Records

**Ann E.K. Sobel**

A multitude of projects are under way that support the transition to electronic health records, which enable the exchange of health information among healthcare-related parties while maintaining patient privacy and offering security protections.

### 24 Electronic Health Records: The HHS Perspective

**Doug Fridsma**

Electronic health records can deliver complete and accurate health information to patients and their providers, allowing better access to that information and, ultimately, empowering patients to take an active role in their healthcare.

### 27 Personal Health Records: New Means to Safely Handle Health Data?

**Inmaculada Carrión Señor, José Luis Fernández Alemán, and Ambrosio Toval**

Personal health records offer a way to manage health data while lessening healthcare costs, improving patient data quality, and fostering healthcare efficiency, but privacy and security issues are particularly important considerations for PHR designers.

### 34 Electronic Case Records in a Box: Integrating Patient Data in Healthcare Networks

**Raik Kuhlisch, Ben Kraufmann, and Hannes Restel**

An innovative deployment concept decouples document sources and electronic health records

For more information on computing topics, visit the Computer Society Digital Library at [www.computer.org/csdl](http://www.computer.org/csdl).

### 42 Fusion: Managing Healthcare Records at Cloud Scale

**Sujoy Basu, Alan H. Karp, Jun Li, James Pruyne, Jerry Rolia, Sharad Singhal, Jaap Suermondt, and Ram Swaminathan**

An experimental open, cloud-based platform for large-scale, low-cost delivery of healthcare applications enables broader use of patient-centric management of electronic health records and facilitates the secure and seamless sharing of EHRs among stakeholders within a healthcare system.

### 50 Testing the Nation's Healthcare Information Infrastructure: NIST Perspective

**Kevin Brady, Ram D. Sriram, Bettijoyce Lide, and Kathleen Roberts**

The National Institute of Standards and Technology is enabling the development of an integrated healthcare information infrastructure by developing test tools and techniques that will facilitate seamless exchange of information across the healthcare enterprise.

## PERSPECTIVES

### 59 Debugging on the Shoulders of Giants: Von Neumann's Programs 65 Years Later

**Barry Fagin and Dale Skrien**

A study that examined and executed the programs John von Neumann wrote for the IAS machine reveals time-tested truths about computer architecture, side effects, instruction set design, and automatic programming—truths all foreseen by von Neumann and his team more than 50 years ago.

## ABOUT THIS ISSUE

The cover features in this issue describe projects that are under way to support the mandatory transition to electronic health records, an ambitious endeavor with an aggressive timeline of milestones that poses new and interesting problems pertaining to the sharing of private healthcare information among physicians, institutions, and individuals.

MULTIMEDIA

IEEE Computer Society: <http://computer.org>  
 Computer: <http://computer.org/computer>  
[computer@computer.org](mailto:computer@computer.org)  
 IEEE Computer Society Publications Office: +1 714 821 8380

Flagship Publication of the IEEE  
 Computer Society

November 2012, Volume 45, Number 11

## RESEARCH FEATURE

### 70 China's Indigenous Innovation Policy: Impact on Multinational R&D

Jason Dedrick, Jian Tang, and Kenneth L. Kraemer

Multinational corporations seeking access to China's burgeoning consumer markets and human resources are establishing R&D centers in the country and developing ways to thread a path through its complex innovation policies.

## COLUMNS

### 6 Computing Conversations

Inventing PHP: Rasmus Lerdorf  
 Charles Severance

### 8 Computing and the Law

A Brief Overview of the America Invents Act  
 Brian M. Gaff, Ralph A. Loren,  
 and Amy M. DeCloux

### 12 32 & 16 Years Ago

Computer, November 1980 and 1996  
 Neville Holmes

### 79 Green IT

Sustainable IT: Challenges, Postures,  
 and Outcomes  
 Edward Curry, Bill Guyon, Charles  
 Sheridan, and Brian Donnellan

### 82 Out of Band

Strafor or Stratagaint  
 Hal Berghel

### 87 Identity Sciences

Biometric Authentication: System Security and User Privacy

Anil K. Jain and Karthik Nandakumar

### 93 Social Computing

Customer Service 2.0: Where Social Computing Meets Customer Relations

Frank Bi and Joseph A. Konstan

### 120 Forward Slash

Love the Show!

David Alan Grier and Erin Dian Dumbacher

## NEWS

### 14 Technology News

Big Iron Moves Toward Exascale Computing  
 Neal Leavitt

### 18 News Briefs

Lee Garber

## MEMBERSHIP NEWS

### 96 IEEE Computer Society Connection

### 99 Call and Calendar

## DEPARTMENTS

4 Elsewhere in the CS

69 Computer Society Information

102 Career Opportunities

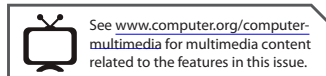

We welcome your letters. Send them to [letters@computer.org](mailto:letters@computer.org). Letters are subject to editing for style, clarity, and length.



Reuse Rights and Reprint Permissions: Educational or personal use of this material is permitted without fee, provided such use: 1) is not made for profit; 2) includes this notice and a full citation to the original work on the first page of the copy; and 3) does not imply IEEE endorsement of any third-party products or services. Authors and their companies are permitted to post the accepted version of their IEEE-copyrighted material on their own Web servers without permission, provided that the IEEE copyright notice and a full citation to the original work appear on the first screen of the posted copy. An accepted manuscript is a version which has been revised by the author to incorporate review suggestions, but not the published version with copyediting, proofreading and formatting added by IEEE. For more information, please go to: [http://www.ieee.org/publications\\_standards/publications/rights/paperversionpolicy.html](http://www.ieee.org/publications_standards/publications/rights/paperversionpolicy.html).

Permission to reprint/republish this material for commercial, advertising, or promotional purposes or for creating new collective works for resale or redistribution must be obtained from the IEEE by writing to the IEEE Intellectual Property Rights Office, 445 Hoes Lane, Piscataway, NJ 08854-4141 or [pubs-permissions@ieee.org](mailto:pubs-permissions@ieee.org). Copyright © 2012 IEEE. All rights reserved.

Abstracting and Library Use: Abstracting is permitted with credit to the source. Libraries are permitted to photocopy for private use of patrons, provided the per-copy fee indicated in the code at the bottom of the first page is paid through the Copyright Clearance Center, 222 Rosewood Drive, Danvers, MA 01923.

IEEE prohibits discrimination, harassment, and bullying. For more information, visit [www.ieee.org/web/aboutus/whatis/policies/p9-26.html](http://www.ieee.org/web/aboutus/whatis/policies/p9-26.html).

## ELSEWHERE IN THE CS



# Computer Highlights Society Magazines

**T**he IEEE Computer Society's lineup of 12 peer-reviewed technical magazines cover cutting-edge topics in computing, including scientific applications, Internet computing, machine intelligence, pervasive computing, security and privacy, digital graphics, and computer history. Select articles from recent issues of Computer Society magazines are highlighted below.

## IEEE Annals of the History of Computing

Hewlett-Packard introduced its HP-65 programmable pocket calculator in January 1974, advertising it as a "personal computer," in what computing historian Paul Ceruzzi thought might be the first use of the term in print. A feature article in *Annals'* July-September issue, "Once upon a Pocket: Programmable Calculators from the Late 1970s and Early 1980s and the Social Networks around Them," traces the evolution of these devices as well as the user communities that grew up around them and their influences on later PC markets and software development.

## IEEE Computer Graphics AND APPLICATIONS

CG&A introduces a new department, "Spatial Interfaces," in its September/October issue. In the first installment, researchers from the MIT Media Lab and University of British Columbia review emerging technologies that significantly enhance glasses-free 3D display. In "Compressive Light Field Displays," the researchers describe their work on a 3D output device that emits compressed representations of light fields, which are then decoded by integration in the human eye. "We're inspired by the promise that future generations of compressive displays will approach the realism of the physical world with technology that's available today," they conclude.

## Computing IN SCIENCE & ENGINEERING

"Understanding Long-Term Earthquake Behavior through Earthquake Simulation" is the lead article in *CiSE's* September/October special issue on computational earthquake science. Authors Eric M. Heien and Michael Sachs of the University of California, Davis, describe the Virtual California simulation code, which consists of three major components: a fault model (the only part of the system that's California-specific), a set of quasistatic interactions, and an event model. It's one of several topologically realistic, system-level fault code collections that researchers use to construct ensemble earthquake forecasts similar to those used in weather and climate studies.

## Intelligent Systems

In the July/August issue of *IS*, "High-Frequency Trading: The Faster, the Better?" looks at computerized HFT as a culprit in the 998-point drop in the Dow Jones Industrial Average of major US stock prices that occurred between 2:31 and 2:51 p.m. on 6 May 2010. "This drop, subsequently known as the Flash Crash," writes author Rahul Savani of the University of Liverpool, "caused a temporary loss of more than US\$1 trillion in market value, with some major stocks briefly falling to \$.01 per share." Although prices quickly rebounded in the following days, Savani reviews new evidence that HFT trades not only caused the Flash Crash but might also be disrupting genuine economic trading. He also considers options for regulating them and the role of agent-based modeling.

## IEEE Internet Computing

"Priming for Better Performance in Microtask Crowdsourcing Environments" is the lead article in *IC's* September/October theme on crowdsourcing. Authors Robert R. Morris

of MIT, Mira Dontcheva of Adobe Advanced Technology Labs, and Elizabeth M. Gerber of Northwestern University describe two experiments in which they used the psychological technique of affective priming to improve quality in paid crowdsourcing tasks. “We have the power to build on many years of cognitive science research,” they conclude, “and make interfaces and systems that leverage our innate human abilities and empower us to be more creative, productive, and successful.”

## IT Professional

TECHNOLOGY SOLUTIONS FOR THE ENTERPRISE

*IT Pro's* September/October issue is a special theme on mobile and wireless technologies. “Analysts predict that by 2016, there will be 10 billion connected mobile devices in use globally, and smartphone traffic will be 50 times what it is today,” write the guest editors, led by Irena Bojanova of the University of Maryland University College, in their introduction. They present five articles addressing issues that this connectivity raises, including mobile data service deployments, mobile data security and privacy, and upcoming 4G networks.

## IEEE micro

“Helix: Making the Extraction of Thread-Level Parallelism Mainstream” is the lead article in *Micro's* July/August theme issue on parallelizing sequential code. Researchers from Harvard University and the University of Cambridge describe their work on the Helix prototype compiler, which extracts thread-level parallelism automatically from sequential programs by transforming select loops into parallel form. In evaluations using benchmarks from the SPEC CPU2000 suite on a real processor, Helix compared favorably to Doacross, the most similar historical approach to loop parallelization.

## IEEE MultiMedia

*MultiMedia's* July-September theme issue on large-scale multimedia data collections opens with “The Community and the Cloud: Multimedia Benchmark Dataset Development.” On the basis of experience with the MediaEval Multimedia Benchmark, the authors present a specific example of crowdsourcing as a viable method for developing multimedia ground truth.

## IEEE pervasive COMPUTING

MOBILE AND UBIQUITOUS COMPUTING

An article in *PvC's* July-September issue, “GroupEnergyTable: An Interactive Tabletop for Energy Conservation,” describes a tool for supporting group exploration of home electricity

and transportation data. Researchers from Microsoft, AccuSpec Electronics, and the University of Washington present results from a two-month user study that achieved 3 to 20 percent reductions in home energy use among participants who were already low-consuming energy users.

## IEEE SECURITY & PRIVACY

SECURITY, PRIVACY, AND TRUST

*S&P's* September/October issue is a special theme on e-voting security, guest edited by Michael Shamos of Carnegie Mellon University and Alec Yasinsac of the University of South Alabama. They introduce two articles that focus on algorithms that can provide inherent voting integrity and two that look at post-voting period audits. The issue also includes a roundtable discussion, “Electronic Voting Security 10 Years after the Help America Vote Act,” featuring Merle S. King, executive director of the Center for Election Systems at Kennesaw State University, and Brian Hancock, director of voting system testing and certification at the US Election Assistance Commission.

## IEEE Software

*Software's* November/December issue is a special theme, “Technical Debt: From Metaphor to Theory and Practice.” Guest editors Philippe Krichen of the University of British Columbia and Robert L. Nord and Ipek Ozkaya of the Software Engineering Institute introduce the concept of technical debt and its original description—“not quite right code which we postpone making it right”—through its place in leading software development schema to its eventual dilution to “anything that adds to the friction from which software development endeavors suffer.” After defining the term more precisely, they introduce four articles to illustrate different perspectives on technical debt as well as a point/counterpoint column debating its merits in practice.



## COMPUTING CONVERSATIONS

# Inventing PHP: Rasmus Lerdorf

Charles Severance  
University of Michigan

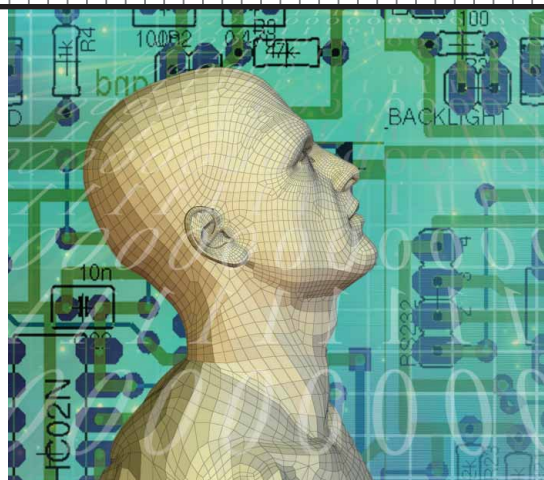

Unique among most of its peers, PHP wasn't conceived as a pure programming language.

Originally conceived as an HTML templating language, Hypertext Preprocessor didn't start its life as a pure programming language. Instead, Rasmus Lerdorf created PHP in 1994 by collecting the code and utilities written in C that he was using to build websites for various clients:

I was living in Toronto and doing Web application consulting for a number of companies. I wrote the same code over and over—basically, CGI [Common Gateway Interface] scripts written in C. I wrote code to handle forms, POST data, filtering, and other common Web things that you have to write in C when you're writing CGI programs. It was kind of tedious and boring, so if I could reduce the amount of time I had to spend programming, maximize the output, and get to the solution quicker, then that was my goal with PHP. I put all my common stuff into a C library, hacked it into the NCSA [National Center for Computing Applications] webserver, and then added a templating system on top of it to let me easily call into it.

The first version of PHP was simply a productivity tool that enabled Lerdorf to accelerate his development across his multiple clients who needed Web applications. PHP was quickly

embraced by other Web developers, who continue to build on and improve it. To watch the full interview with Lerdorf, visit [www.computer.org/computingconversations](http://www.computer.org/computingconversations).

## HUMBLE BEGINNINGS

In the Web's early days, the developer community was small, so it didn't take long for Lerdorf's colleagues to find out about his software and start asking for copies for their own clients:

Other people started asking me how I built these applications, and I said I was using this little tool I built. They asked if they could have it, and I said, "Sure, why not?" My toolkit wasn't what I was selling—I was selling my services of solving problems, and the tool itself is irrelevant, really. It's just my hammer.

After other programmers started using it seriously, they found bugs, fixed them, and sent him patches. Using these patches, he modified his utility library and templating engine and improved the applications he was building for his customers:

That's when open source really hit me. This was in 1994-1995 before the term "open source" existed. I got together with a group of my peers, other people

interested in the Web and solving the Web problem from all around the world. We all faced similar issues and collaboratively we could build a tool that solved our problem. That was really how PHP got off the ground.

Because PHP was initially conceived as a collection of library utilities rather than as a new programming language, Lerdorf never felt the need to shape its future direction. He felt PHP would thrive if he opened the code base to other people and approaches:

I learned a bit along the way that, for this to grow, I had to give up control of PHP—I had to let other people have some control. I couldn't rewrite patches, both because I'm lazy and it's a lot of work and also to give people some ownership. Once they have full control over their part of it, then they become much more invested in it and passionate. It's not just them contributing to my project—it becomes our project, and that really changed the nature of PHP. This happened around 1997 or so, when I really delegated it out and gave people full access to the source code repository that I was using.

Once Lerdorf allowed other people to become involved in PHP's evolution,

VIDEO

AUDIO



he quickly built a large following around the product:

The Web grew, and PHP was at the right place at the right time. But also, it was very, very easy to get in and get started using PHP and contributing to it. Even today, it doesn't take much to get a source code repository account in the PHP project. We have close to 1,400 people with accounts, which means those people can all commit to some part of the repository. Slightly more than half the people have committed something in the last year and a half.

The only way to manage all those volunteers is to let them manage themselves. Within the PHP community, many small, dedicated groups work closely together and focus on one aspect of PHP and collectively own it. Lerdorf prefers to let passionate volunteers move forward, even if they make little mistakes that need to be fixed later after their contributions are reviewed by more experienced members of the community.

### CROWDSOURCING

Through the PHP Extensions Community Library (PECL), interested groups of volunteers can incubate an idea and then build interest in their feature. Once a feature is in broad use, it can become part of the core distribution, such as the JSON extension in PHP 5.1:

That's how new features eventually creep in—they live outside of the core tree, get enough penetration and enough people to install them, and then we see Linux distributions pulling them into their core version of PHP. We look at what's happening out there, but there's no real management of that either.

In many open source projects, an individual or small group controls the project's architectural direction to ensure consistency across

the product. Lerdorf even leaves architectural decisions about PHP to the community:

It's a meritocracy. Code speaks. If you write a patch or a piece of code to implement a feature, that says a lot. If someone wants to disagree with that way of doing things, or if they can offer an alternative implementation, that's a really good argument. If all they do is whine about it, that's a really bad argument, and chances are, the implementation will win even though it might not be the best way of doing things. If there's code and it sort of works, that's what we go with, and that has always been the default. It doesn't always lead to consistency, but it does lead to getting new features and actually being able to do something. Being able to connect to this type of database even though it might not be the best way of doing it, at least it gets you there. That's what PHP has always been about—solving a problem. We would rather have an ugly feature than not have a feature at all.

**W**hen I asked Lerdorf about PHP's future roadmap, his answer was that it would match the Web's evolution. As the Web moves into new areas and uses new technologies, PHP needs to make those new technologies and approaches available to PHP developers. There's no master plan except to be useful to people developing Web applications. **■**

*Charles Severance, Computing Conversations column editor and Computer's multimedia editor, is a clinical associate professor and teaches in the School of Information at the University of Michigan. You can follow him on Twitter @drchuck or contact him at [csev@umich.edu](mailto:csev@umich.edu).*

**cn** Selected CS articles and columns are available for free at <http://ComputingNow.computer.org>.



## Call for Articles

**IEEE Software** seeks practical, readable articles that will appeal to experts and nonexperts alike. The magazine aims to deliver reliable, useful, leading-edge information to software developers, engineers, and managers to help them stay on top of rapid technology change. Topics include requirements, design, construction, tools, project management, process improvement, maintenance, testing, education and training, quality, standards, and more.

Author guidelines:  
[www.computer.org/software/author.htm](http://www.computer.org/software/author.htm)  
Further details: [software@computer.org](mailto:software@computer.org)  
[www.computer.org/software](http://www.computer.org/software)



## COMPUTING AND THE LAW

# A Brief Overview of the America Invents Act

**Brian M. Gaff, Ralph A. Loren,  
and Amy M. DeCloux**

*Edwards Wildman Palmer LLP*



AUDIO

The eleventh in a series of articles providing basic information on legal issues facing people and businesses that operate in computing-related markets discusses the America Invents Act.

**S**igned into law on 16 September 2011, the America Invents Act (AIA) made many significant changes to US patent law, including a transition to a first-inventor-to-file system and the institution of post-grant review, which allows challenging a patent on any grounds related to patentability within nine months of a patent's issuance.

In our September 2012 column, we discussed the post-grant review procedure and other methods the AIA provides to challenge patents ("Patent Reform: New Tools for Challenging Patent Validity as of September 2012," pp. 9-11). In this month's installment, we provide a brief overview of other aspects of the AIA.

Be sure to check the IEEE Computer Society's website for the podcast that accompanies this article ([www.computer.org/portal/web/computingnow/computing-and-the-law](http://www.computer.org/portal/web/computingnow/computing-and-the-law)).

## FIRST TO FILE

Most parts of the AIA took effect one year after signing—on 16 September 2012. However, the first-to-file system will become effective on 16 March 2013.

Traditionally, US patents were granted to those persons who were the first to invent the subject matter that the patent covered. That meant that even if multiple people independently conceived the invention, and each person applied for a patent, the person who invented first was the one eligible to receive the patent. The US Patent Office used an administrative procedure—known as an interference—to resolve disputes over who was the first to invent.

That will all change for many patent applications filed on or after 16 March 2013. For those applications, the inventor who was the first to file is deemed the true inventor eligible for

a patent. If others independently conceived the invention and filed their patent applications after the person who filed first, they will lose their ability to get a patent.

While there are some very narrow exceptions to this, it's important to realize that this rule also holds even when a later filer conceived the invention before the first filer. In other words, if a person who is first to conceive an invention delays filing a patent application, and a second person later independently conceives the same invention and files an application right away, the first inventor will likely be ineligible for a patent; the second inventor will win.

One aspect of US patent law limits this rule's rigidity: the one-year grace period after public disclosure for an inventor to file an application. This allows an inventor to make a public disclosure about the invention and

delay filing an application for up to one year from the date of the disclosure. If that disclosure occurs and then someone else files a patent application on the same invention before the inventor has filed an application, the inventor might be able to rely on the date of his earlier disclosure. This could allow the second filer to be eligible for a patent. Be careful, though, because the scope of the disclosure is important to the scope of the patent.

Because the focus is now on the patent application filing date instead of the date of the invention, the definition of prior art has changed. Prior art is preexisting information, such as that disclosed in a printed publication, that describes the invention. Public use or sale of the invention is prior art as well.

Before the AIA, prior art that predated the date of the invention could prevent an inventor from obtaining a patent. Now, the prior art need only be earlier than the application filing date. The public use or sale of the invention used to be limited to acts in the US; these acts in another country are now considered prior art as well. This makes more prior art available as roadblocks to getting a patent.

This first-to-file system is how most patent offices outside the US have operated. This change makes the US patent system more similar to systems in other countries. However, inventors—and their employers—need to recognize how important it is to get their patent applications on file quickly, or at least consider the merits of making strategic disclosures to preserve their patent rights.

## EFFECTS ON PATENT LITIGATION

The AIA will change how patent litigation is conducted. In particular, the AIA provides two new mechanisms for challenging the validity of patents: post-grant review and inter partes review. These procedures are administrative, not judicial, and are conducted in the US Patent Office.

Their goal is to provide individuals or businesses accused of infringing a patent with an avenue to challenge that patent more quickly and at less cost compared to litigation in federal court. Our September 2012 column in *Computer* and the associated podcast provide a full discussion of post-grant and inter partes review.

Parties accused of patent infringement now have a new defense that they can raise in court: *prior commercial use*. If an accused infringer can show that he commercially used what the patent covers at least one

**Because the focus is now on the patent application filing date instead of the date of the invention, the definition of prior art has changed.**

year before the earlier of the patent application filing date or the date the invention was disclosed, he might prevail. Before the AIA, this defense was limited to patents that cover business methods. The AIA expanded the defense to allow its use with patents that cover “any subject matter consisting of a process, machine, manufacture or composition of matter used in a manufacturing or other commercial process.” However, an accused infringer can’t use this defense if an institute of higher education owns the patent.

A typical occurrence before the AIA was the filing of patent infringement lawsuits that had one plaintiff (the patent owner) and multiple—sometimes dozens of—defendants (the accused infringers). Usually, there were no business or corporate connections between the defendants; the only commonality was that the plaintiff was accusing all of them of infringement of the same patent,

which complicated litigation. The AIA now prohibits joining unrelated defendants in a single action for patent infringement unless there are common facts and the defendants were involved together in the same acts that caused the alleged infringement. The fact that separate defendants are accused of infringing the same patent isn’t a basis for bringing the defendants together in a single lawsuit.

When a court determines that a party has infringed a patent, it will typically consider whether that infringement was willful. Willfully infringing a patent essentially requires that the infringer knew or should have known that there was a high likelihood that its actions constituted infringement of a valid patent. If a court determines that the infringement was willful, then the penalty that the infringer pays to the patent owner could be doubled or tripled.

Usually, an accused infringer will get advice from a patent lawyer about whether it is infringing a patent. The lawyer typically gives the advice in the form of an opinion—a written document that analyzes the patent at issue and the potentially infringing item. Before the AIA, the failure to get such an opinion could be used to prove willful infringement. The AIA prevents patent owners from raising the lack of an opinion as a basis to prove willful infringement.

Other AIA-inspired changes to litigation include ending challenges to patent validity based on a failure to satisfy the Best Mode requirement, which obligates an inventor to, at the time of filing a patent application, disclose the best way that he knows to use, or practice, the invention. Also, the AIA modified the patent marking requirements to allow virtual marking of products with the patent numbers that cover those products, and bars litigation based on marking products with the numbers of patents that have expired. The latter issue

## COMPUTING AND THE LAW

was a source of hundreds of lawsuits from 2009 to 2011.

Additional effects that the AIA will have on litigation will likely become apparent over time. The law has been in force for only a short time. As lawsuits are filed and progress through the courts, the law will become more fully defined and provide additional guidance to patent owners and others impacted by the changes to the law.

### OTHER ASPECTS OF THE AIA

The AIA has some other provisions, including the following.

#### Derivation proceedings

Derivation proceedings, a mechanism that counterbalances the first-to-file system, are designed so that the first (true) inventor can challenge the first applicant's right to a patent by demonstrating that the first applicant is claiming an invention derived from the true inventor. With many limitations, derivation proceedings can be conducted administratively either in the US Patent Office or litigated conventionally in federal court.

The derivation proceedings concept isn't new—only the procedure is new. It's triggered when both involved parties file patent applications and at least one of the involved parties charges that the other party derived the invention from it. However, only the party having the later effective filing date can initiate derivation proceedings. Further, the claims in the competing patents or patent applications must not be patentably distinct.

It could be challenging for the first inventor to prevail over the first applicant in derivation proceedings. As the term implies, the focus is on whether the first applicant derived the invention from the first inventor. Therefore, the first inventor might need to provide evidence that important details of his invention were transmitted to the first applicant and that the first applicant used them to file a patent application. This contrasts with situ-

ations in which multiple inventors independently conceived the same invention. Finding evidence of transmission and use may be difficult in practice.

#### Preissuance submissions

Third parties can submit any reference, such as a patent, published patent application, or other printed publication, during the examination of a patent application for the patent examiner to consider. The patent office will include the reference in the record of the examination. In contrast to the pre-AIA practice that limited the time for submitting references to two months following the publication of patent application, the AIA extends the time to the earlier of (i) the date a notice of allowance is given or mailed in the application, or (ii) the later of either six months after publication, or the date of the first rejection during the examination of the application.

#### Fees

The AIA reduced certain fees for qualified small entities and introduced a new class called *micro entities*. A micro entity is an applicant that qualifies as a small entity, hasn't been named as an inventor on more than four previously filed patent applications, doesn't have a gross income exceeding three times the median household income for the preceding calendar year, and hasn't transferred ownership interest in the application to another entity exceeding the income limit. Institutes of higher education are included in the definition of micro entities, but this definition is subject to further regulations to be prescribed.

#### Filing by assignee

The AIA allows assignees of inventions such as employers of inventors to file patent applications. This will facilitate filing when the inventor won't cooperate, can't be found, or is incapacitated.

#### Tax strategies

Inventions that relate to strategies for reducing, avoiding, or deferring taxes aren't patentable. However, inventions that relate to preparing and filing tax returns or are used solely for financial management aren't covered by this prohibition.

There are other parts of the AIA that, as they come into force, will become clearer and for which the effects will be better understood. There are usually unintended consequences that result when large-scale legislation is enacted. Time will tell the scope and severity of these consequences, if any, that relate to the AIA. Until then, inventors, patent applicants, and patent owners should stay in close contact with their patent attorneys to keep abreast of AIA-related matters and to consider whether changes to their patent strategies are warranted. **C**

*Brian M. Gaff is a senior member of IEEE and a partner at the Edwards Wildman Palmer LLP law firm. Contact him at [bgaff@edwardswildman.com](mailto:bgaff@edwardswildman.com).*

*Ralph A. Loren is a partner at the Edwards Wildman Palmer LLP law firm. Contact him at [rloren@edwardswildman.com](mailto:rloren@edwardswildman.com).*

*Amy M. DeCloux is an associate at the Edwards Wildman Palmer LLP law firm. Contact her at [adeclox@edwardswildman.com](mailto:adeclox@edwardswildman.com).*

The content of this article is intended to provide accurate and authoritative information with regard to the subject matter covered. It is offered with the understanding that neither IEEE nor the IEEE Computer Society is engaged in rendering legal, accounting, or other professional services or advice. If legal advice or other expert assistance is required, the services of a competent professional person should be sought.



## Instant Access to IEEE Publications

Enhance your IEEE print subscription with online access to the IEEE Xplore® digital library.

- Download papers the day they are published
- Discover related content in IEEE Xplore
- Significant savings over print with an online institutional subscription

Start today to maximize your research potential.

Contact: [onlinesupport@ieee.org](mailto:onlinesupport@ieee.org)  
[www.ieee.org/digitalsubscriptions](http://www.ieee.org/digitalsubscriptions)

*"IEEE is the umbrella that allows us all to stay current with technology trends."*

Dr. Mathukumalli Vidyasagar  
Head, Bioengineering Dept.  
University of Texas, Dallas



 **IEEE**  
Advancing Technology  
for Humanity

## 32 &amp; 16 YEARS AGO

**NOVEMBER 1980**

[www.computer.org/csdl/mags/co/1980/11/index.html](http://www.computer.org/csdl/mags/co/1980/11/index.html)

**SPECIAL MESSAGE** (p. 7) "... With the advent of computer engineering departments at the universities and the growth of software engineering, the institute should encourage maximum participation in this exciting new area. Now might be the time to consider changing the name of the institute from the Institute of Electrical and Electronics Engineers to the Institute of Electrical and Computer Engineers. In my opinion this would encourage increased participation of the computer professional in both the Computer Society and the IEEE."

**BALLISTIC COMPUTING** (p. 37) "One of the world's most complex undertakings in the past two decades has been the US Army Ballistic Missile Defense Program. A critical part of the large research and development investment in this program has been the effort to develop data processing hardware and software technologies to meet the computational challenges of this incredibly complex problem. The demands for a computing system that will deliver a throughput of hundreds of millions of instructions per second at some undetermined point in its life cycle, with a high confidence that correct execution will occur, challenge even the most advanced technologists."

**SUPER DATA FLOW** (pp. 48-49) "Data flow architectures offer a possible solution to the problem of efficiently exploiting concurrency of computation on a large scale, and they are compatible with modern concepts of program structure. Therefore, they should not suffer so much from the difficulties of programming that have hampered other approaches to highly parallel computation."

**DISTRIBUTED TASKS** (p. 57) "... Distributed processing applications range from large data base installations where processing load is distributed for organizational efficiency to high-speed signal processing systems where extremely fast processing must be performed in a real-time environment. But, like any new concept, distributed processing has problems which must be solved before it can become part of the accepted processing repertoire of system designers."

**VECTOR COMPUTERS** (p. 82) "Improvements in the second generation of vector supercomputers include such hardware features as extensive use of LSI memory chip technology, improved memory management to enhance throughput performance, better designs to link and chain execution strings within the CPU, and much higher effective-speed I/O operations integrated into the architecture. Improved software items are a result of both better-working hardware and better compilers. ..."

**BUSINESS COMPUTING**

(p. 84) "In spite of the advances made in the past 33 years, business computing is far from being a mature technology."

The advances to come in the next 33 years at the technical, business, and social levels can reasonably be expected to match those achieved so far."



**SYSTEM PACKAGING** (p. 100) "... As semiconductors in electronic equipment go to VLSI ... a greater percentage of total system cost will be in packaging, a greater percentage of total design and manufacturing delay will be in packaging, and a greater percentage of the cost of testing solutions will be affected by packaging technology. For these reasons, the system packaging engineer will most certainly be needed to ensure system manufacture at reasonable cost."

**WHISTLE BLOWING** (p. 104) "I am occasionally consulted by junior employees concerning 'whistle blowing'—whether the employee, or 'a friend of his,' should tell management about another employee's illegal, unethical, or dishonest action. Responding to such an inquiry is not easy—a company's high principles are not always universally respected by management in practice and often the farther down in the management chain one goes, the greater the divergence between principles and practice. Consequently, I was delighted to discover an article on the dangers of whistle blowing to which I now can refer inquirers ..."

**COMPUTERS AND GOVERNMENT** (p. 121) "Definition of government's role is the key to the effective implementation of information technology, but [Simon] Ramo sees five obstacles to the crystallization of that definition: (1) the government is fragmented, (2) it is subject to short-range pressures, (3) bureaucracy is not well-suited to solving complex problems, (4) government tends to be equivocal and unclear, and (5) it has trouble attracting and retaining experts in this difficult-to-comprehend technology."

**OFFICE COMPUTERS** (p. 122) "Office procedures will change considerably through the 1980s in response to technological evolution. Four new market research reports measure the impact of voice-activated typewriters, advanced imager/processors, falling disk drive costs, and shifting DP maintenance cost policies."

## NOVEMBER 1996

[www.computer.org/csdl/mags/co/1996/11/index.html](http://www.computer.org/csdl/mags/co/1996/11/index.html)

**TIME SHARING** (p. 6) “One programming language, JOSS (Johnniac Open Shop System), does have a specific birth date—November 7, 1960. JOSS was developed by J.C. (Cliff) Shaw at Rand Corporation to give users a hands-on connection to a computer at a time when operating systems had become the major management tool of computing center directors to speed up program turnaround and eliminate programmers’ direct use of the console. JOSS allowed 12 (apparently) simultaneous users on a machine, preceding by a year Fernando Corbató’s invention of time-sharing.”

**SECURITY** (p. 8) “The CERT Coordination Center’s collection of software vulnerability data provides empirical evidence that vendors continue to release software containing essentially the same classes of security flaws, repeatedly, year after year. ...”

**SURVIVAL** (p. 10) “Tools that solve *general* problems *efficiently* live forever. We still compute with transistorized binary logic circuits, and we will be doing so 20 years hence. Consequently, back-end software will be written in C 20 years hence because C can efficiently map a general class of procedural algebraic problems onto transistorized binary logic circuits.”

**THE TELECOMMUNICATIONS ACT** (p. 16) “... it is unclear what the Telecommunications Act’s long-term effects will be and whether the law will fulfill its promise. And under any circumstances, it looks as though consumers should not look for the large-scale development, introduction, and deployment of new technologies in the near future.

“This will be the case partially because many telecommunications companies will be busy in the near future pursuing lawsuits, looking for partners, and figuring out what they need to do to cope with the Telecommunications Act.”

**PROGRAM ERROR** (p. 20) “An inquiry has revealed that a software design error and insufficient software testing caused an explosion that ended the maiden flight of the European Space Agency’s Ariane 5 rocket less than 40 seconds after liftoff on June 4, 1996.”

**Y2K** (p. 21) “The US government says it may have to spend up to \$30 billion to make sure its computers can cope with the Year 2000 problem. Others think the cost could run even higher.”

**THE PENTIUM PRO** (p. 47) “Intel designed the Pentium Pro processor to be used gluelessly (without extra chips) in

shared-memory multiprocessor systems. Our task was to validate that multiple Pentium Pro processors and the 82450GX chipset would function correctly and perform as specified in such systems.”

**ENGINEERED TESTING** (p. 61) “*Software-reliability-engineered testing* combines the use of quantitative reliability objectives and operational profiles (profiles of system use). The operational profiles guide developers in testing more realistically, which makes it possible to track the reliability actually being achieved.”

**RELIABILITY PREDICTION** (p. 69) “Critical business applications require reliable software, but developing reliable software is one of the most difficult problems facing the software industry. After the software is shipped, software vendors receive customer feedback about software reliability. However, by then it is too late; software vendors need to know whether their products are reliable before they are delivered to customers. *Software reliability growth models* help provide that information. ...”

**MEASURING QUALITY** (pp. 78-79) “... The traditional algorithms and metrics from the hard engineering disciplines either come up short when applied to software or are easily misapplied. Software engineering is a discipline that is largely nonparametric and resistant to traditional modes of analysis. Unquestionably, we need common methods of determining the business value of software. We must also generate and promote the human factors and activity statistics necessary to manage and steer software development.”

**ELECTRONIC TRANSACTIONS** (p. 92) “Possibly in reaction to the Netscape-MasterCard alliance, Microsoft and Visa began to develop a competing electronic transaction standard, the Secure Transaction Technology. Later, Netscape and MasterCard accused Visa and Microsoft of planning to charge a royalty for each use of their standard. Eventually the differences were resolved, and in February MasterCard and Visa agreed to support a royalty-free standard called Secure Electronic Transactions.”

**THE VIRTUAL UNIVERSITY** (p. 95) “Following the Monterey conference, a group of higher education network leaders reviewed the technical requirements for the virtual university and for today’s research community. They determined that by the year 2000, higher education will require an advanced, open, internetworking fabric ...”

Editor: Neville Holmes; [holmeswn@yahoo.com.au](mailto:holmeswn@yahoo.com.au)

## TECHNOLOGY NEWS

# Big Iron Moves Toward Exascale Computing

Neal Leavitt

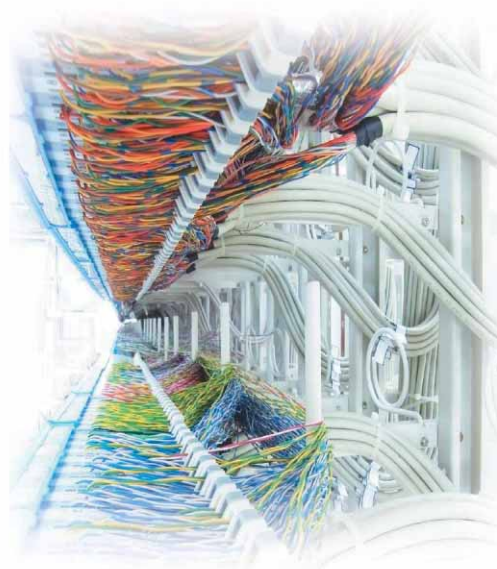

**Developers and researchers face many challenges in trying to produce exascale supercomputers, which would perform a thousand times faster than today's most powerful systems.**

**S**upercomputing is entering a new frontier: the exaflops era, in which high-performance machines could run a thousand times faster than today's petaflops systems.

Some experts say that someone could build an exaflops machine—capable of performing  $10^{18}$  floating-point operations per second—by the end of this decade.

More speed would be welcome, as supercomputing is used in many areas—including nuclear-weapon testing simulations, analyzing the geologies of various areas for possible oil deposits, astronomy, astrophysics, financial services, life sciences, and climate modeling—that could benefit from higher performance.

“This will necessitate new hardware and software paradigms,” said Arend Dittmer, director of product marketing for Penguin Computing, a high-performance computing (HPC) services provider.

But for the first time in decades, computing-technology advances might be threatened, said John Shalf, Computer Science Department head

in the US Lawrence Berkeley National Laboratory's Computing Research Division.

“While transistor density on silicon is projected to increase with Moore's law, the energy efficiency of silicon is not,” he noted. “Power [consumption] has rapidly become the leading design constraint for future high-performance systems.”

Thus, said Dittmer, software developers will have to optimize code for power efficiency rather than just performance.

Researchers are also looking into a number of disruptive hardware technologies that could dramatically increase efficiency, including new types of memory, silicon photonics, stacked-chip architectures, and computational accelerators, explained Dimitrios S. Nikolopoulos, professor and director of research at Queen's University Belfast.

The US, China, Japan, the European Union, and Russia are each investing billions of dollars in supercomputer research.

Achieving HPC improvements could even help those who don't

use supercomputers. “As always,” explained Intel Labs Fellow Shekhar Borkar, “the technology will trickle down to mainstream computing.”

However, building exascale machines faces some significant challenges.

## BACKGROUND

University of Illinois at Urbana-Champaign researchers started building supercomputers in the early 1950s and parallel supercomputers in the early 1960s.

Seymour Cray, who founded Cray Research—the forerunner of today's Cray Inc.—in the 1970s, is considered the father of commercial supercomputing.

Early supercomputers were designed like mainframes but adapted for higher speed.

In the 1980s, the next wave of HPC machines used custom processors. During the 1990s, general-purpose commercial processors began offering good performance, low prices, and reduced development costs, which made them attractive for use in supercomputers, said Stanford University



**Table 1. World's fastest supercomputers as ranked by Top500 ([www.top500.org](http://www.top500.org)), June 2012.**

Rank	Site	Manufacturer	Computer	Country	Cores	Maximum throughput (petaflops)	Power (megawatts)
1	US Lawrence Livermore National Laboratory	IBM	Sequoia	USA	1,572,864	16.30	7.89
2	RIKEN Advanced Institute for Computational Science	Fujitsu	K computer	Japan	795,024	10.50	12.66
3	US Argonne National Laboratory	IBM	Mira	USA	786,432	8.16	3.95
4	Leibniz Rechenzentrum	IBM	SuperMUC	Germany	147,456	2.90	3.52
5	National Supercomputer Center in Tianjin	National University of Defense Technology	Tianhe-1A	China	186,368	2.57	4.04
6	US Oak Ridge National Laboratory	Cray	Jaguar	USA	298,592	1.94	5.14
7	CINECA	IBM	Fermi	Italy	163,840	1.73	0.82
8	Forschungszentrum Juelich	IBM	JuQUEEN	Germany	131,072	1.38	0.66
9	Commissariat a l'Energie Atomique	Bull	Curie thin nodes	France	77,184	1.36	2.25
10	National Supercomputing Center in Shenzhen	Dawning	Nebulae	China	120,640	1.27	2.58

Source: Professor Jack Dongarra, University of Tennessee, Top500 project

professor William Dally, who is also chief scientist and senior vice president of research at GPU maker Nvidia.

The first machine to break the petaflops barrier was IBM's Roadrunner in 2008.

Getting to exascale computing is critical for numerous reasons. Faster supercomputers could conduct calculations that have been beyond reach because of insufficient performance, noted IBM Research director of computing systems Michael Rosenfield.

Another issue is that many complex problems have a large number of parameters. The only way to deal with such problems is to simultaneously run multiple sets of calculations using different combinations of parameters, which requires tremendous computational resources.

Bill Kramer, deputy director for the National Center for Supercomputing Applications' (NCSA's) Blue Waters petascale computing project, said research teams are working on difficult problems in areas such as solar science, astrophysics, astronomy, chemistry, material science, medicine, social networks, and neurophysiology.

"All are far more complex to solve than what has been done in the past, and it's only now, with petascale going to exascale, that we can begin to solve these in less than a lifetime," he explained.

### TOMORROW'S BIG IRON

While some aspects of supercomputing—such as the traditional forms of security it uses—are unlikely to change to enable exascale computing, others will.

For example, developers are placing processing engines inside memory, rather than outside, to overcome the bottlenecks of today's memory-to-processor connections. They are also working with alternate programming languages that optimize, enhance, and simplify parallelism, as well as communications and control approaches that improve performance.

### Fastest Supercomputer: IBM's Sequoia

Sequoia, an IBM supercomputer at the US Lawrence Livermore National Laboratory, is part of the company's

BlueGene/Q HPC line and performs 16.3 Pflops.

The Top500 project, in which several academic and research experts rank the world's nondistributed supercomputer systems, placed Sequoia at the top of its list in its recent semi-annual report, as Table 1 shows. Ranking second was Fujitsu's K computer, which performs 10.5 Pflops.

Sequoia, which runs Linux and is primarily water cooled, consists of 96 racks, 98,304 16-core compute nodes, 1.6 million total cores, and 1.6 petabytes of RAM.

Despite being so powerful, the system at peak speeds is 90 times more energy efficient than ASC Purple and eight times more than Blue Gene/L, two other very fast IBM supercomputers.

### Power consumption

Sequoia uses 7.89 megawatts at peak performance. At that rate, a one-exaflops machine would consume 400 MW, about one-fifth of Hoover Dam's entire generation capacity, said Nathan Brookwood, research fellow with semiconductor consultancy Insight 64.

## TECHNOLOGY NEWS

Without improvements, an exascale computer “might need its own nuclear power plant or large hydroelectric dam,” said Carl Claunch, vice president and distinguished analyst with market research firm Gartner Inc.

When an early Univac powered up in the 1950s, the lights dimmed in the surrounding neighborhood, Brookwood noted. “Imagine the impact of powering up a 400-MW supercomputer and watching the lights dim in the Southwest,” he continued. “Future systems must improve their performance per watt by a factor of 40 or more to deliver exascale results within reasonable power envelopes.”

The US Department of Energy has set a goal that supercomputers use no more than 20 MW of power, which would require radical redesigns of processors, interconnects, and memory, noted Alan Lee, vice president of research and advanced development for chipmaker AMD.

Supercomputer designers now routinely incorporate energy-conserving features that turn off idle elements within their chips when possible. Modern chips, noted Stanford’s Dally, use both *power gating*—in which power to parts of a chip is shut off—and *clock gating*—in which the power is left on but the clock is turned off.

Stacked DRAM placed close to the processor increases memory bandwidth while requiring significantly less power to transfer data than current designs, he noted.

Supercomputers could become more energy efficient by using low-power memory and also components that run at lower frequencies, as well as reducing the amount of data movement, added Lee.

In the future, said University of California, San Diego (UCSD) professor Michael Taylor, using highly specialized, low-speed application-specific coprocessors could help decrease energy consumption.

### Processing

Processor performance will be a key factor in exascale computing. And parallelism, created via multiple cores on a chip working on different tasks simultaneously, is driving processor-performance improvements.

Future supercomputers will have more cores per chip and each core will run many threads to hide latency, according to Stanford’s Dally.

There is an emerging consensus that future supercomputers will be heterogeneous multicore computers, with each processing chip having different types of cores specialized for different tasks, he said.

**There could be an exascale computer by the end of this decade.**

For example, Dally explained, the majority of the cores would be throughput-optimized to execute parallelized work quickly and with minimum energy consumption, as is the case with GPUs.

A small number of cores would be latency-optimized, like those in CPUs, for use in critical serial tasks.

For parallel tasks, said AMD’s Lee, GPUs are more energy efficient than CPUs because they use a single instruction to perform many operations and because they run at lower voltages and frequencies.

Each type of processor provides distinct advantages, said Tony King-Smith, vice president of marketing for Imagination Technologies, which designs and licenses multimedia and communications semiconductor cores.

However, using different kinds of cores would not come without challenges. For example, programming multiple types of processors to take advantage of their distinct charac-

teristics can be complex and time consuming.

Investigating such matters is the Heterogeneous System Architecture (HSA) Foundation consortium of chip-makers, academics, equipment manufacturers, software companies, and operating-system vendors.

According to King-Smith, supercomputer developers will face a challenge in balancing performance, power, and chip size.

Moreover, noted Dally, an exascale machine will have to run over a billion parallel threads at any time to keep busy—many times more than today’s fastest computers—and this will require new programming approaches.

Designers of exascale computers could turn to 3D processors with various layers of circuitry stacked on top of one another. Integrating a large processing system this way improves memory access and performance, added Dally.

However, this also creates challenges for cooling and power supply. For example, noted Georgia Institute of Technology assistant professor Richard Vuduc, heat builds up between layers, making them harder to cool. In addition, he said, the inter-layer connections are difficult to design, and there are few tools for developing and testing 3D circuits.

### Memory and interchip communications

Two crucial limitations that exascale computing faces are the increasing speed disparity between a CPU and external memory, and the relative slowdown in interconnect support.

Processing speeds have increased exponentially, but the connecting fabric and memory controllers are still working to keep up.

Introducing solutions such as data compression, as well as optimizing memory organization and usage by adding localized caches and thereby keeping more of the processing on

chip, would improve some memory- and interconnect-related issues, said King-Smith.

Optical links and 3D chip stacking could improve interchip communications and lower power consumption, but further research in this area is necessary, said the UCSD's Taylor. He predicted that optical connections will be built onto chips during the next few years.

However, Stanford's Dally noted, some major technical hurdles must be cleared for this to happen, such as reducing the cost and power dissipation of optical links.

### Internode networking

Many supercomputers use high-speed Ethernet for communication between processing nodes. However, the technology's deep router queues and tendency to occasionally drop packets could create high and unpredictable latencies unsuitable for exascale computing.

Proprietary networking technologies like those used in Cray machines and other supercomputers have lower-latency routers, topologies with fewer hops, and more efficient buffer management, said Bill Blake, Cray's senior vice president and chief technology officer. This approach provides low internode latency and high bandwidth.

However, proprietary technologies are expensive.

### Cooling

Supercomputers generate huge amounts of heat. If the heat is not either cooled or moved away from chips, connectors, and the machine's many other heat-sensitive components, they—and the entire system—will fail.

In the past, supercomputers have used liquid cooling and/or air cooling via fans and heat sinks. Liquid cooling is highly effective, but it can be expensive and would become much more so in exascale systems.

Thus, exascale systems might implement hybrid cooling systems using both liquid and air cooling, said Cray's Blake.

A current trend, noted IBM's Rosenfield, is to use room-temperature water to efficiently conduct heat away from sensitive components without requiring water chillers, which would increase energy consumption.

**A**ccording to Dally, the individual components of an exascale machine could be reliable and have low failure rates, but combining so many into one large computer increases the chance a failure will occur somewhere.

"Concerted government and industry investment and collaboration are needed to overcome the challenges [of exascale computing]. Leadership is necessary ... as evidenced by sovereign strategic commitments to HPC in Japan, China, Russia, and Europe," said IBM's Rosenfield.

Added King-Smith, industry consortiums such as the Khronos Group and the HSA Foundation should continue pushing mainstream adoption of technologies like heterogeneous processing and GPU computation.

In the past 20 years, US expenditures on HPC have steadily grown, but it's not certain that the country will have the first practical exascale system, noted the NCSA's Kramer. The technical challenges and uncertainties; the complexity of industrial, government, and national laboratory partnerships; and budget problems might mean there won't be the focused US effort necessary for such an expensive and technically challenging undertaking.

Current plans for a US system by 2018 are no longer likely to bear fruit, and the country may not have an exascale machine until between 2023 and 2025, Kramer said. "China, Europe, even Russia may arrive at some type of exascale system first," he added.

If exascale systems aren't built and computing performance stalls at today's levels, said the Lawrence Berkeley National Laboratory's Shalf, the information-technology industry will shift from a growth industry to a replacement industry, and future societal impacts of computing will be limited. **□**

*Neal Leavitt is president of Leavitt Communications ([www.leavcom.com](http://www.leavcom.com)), a Fallbrook, California-based international marketing communications company with affiliate offices in Brazil, France, Germany, Hong Kong, India, and the UK. He writes frequently on technology topics and can be reached at [neal@leavcom.com](mailto:neal@leavcom.com).*

**Editor: Lee Garber, *Computer*;**  
[l.garber@computer.org](mailto:l.garber@computer.org)

**cn** Selected CS articles and columns are available for free at <http://ComputingNow.computer.org>.

## COMPUTING THEN

Learn about computing history and the people who shaped it.

<http://computingnow.computer.org/ct>

## NEWS BRIEFS

### Gaming Industry Threatened by Financial Problems

For years, gaming has been seen as a growth industry with a bright financial future. Things have looked good for developers of both games and consoles. However, the industry has now fallen upon hard times.

In the lucrative US market, computer-game sales dropped 8 percent in 2011 to about \$17 billion, and have fallen another 20 percent through August of 2012. According to the Gamasutra website ([www.gamasutra.com](http://www.gamasutra.com)), which covers the gaming industry, US sales have declined each year since reaching a record \$22 billion in 2008. Gamasutra said totals in 2012 could reach about \$18 billion if there is a "miracle" turnaround the rest of this year, \$15 billion if sales don't pick up, and about \$12.5 billion in a "worst case" scenario.

Video-game console sales have also declined steadily since 2008.

As a result of these problems, gaming-company stock values have plummeted.

Numerous industry observers say the worldwide economic problems have contributed to the downturn. They also cite the increasing avail-

ability of cheap games that can be accessed via downloads, largely to smartphones, as opposed to more-costly games accessed via discs that must be played on relatively expensive consoles.

Experts also say that developers have made creative mistakes in their designs and that the big gaming companies have failed to come up with enough blockbuster products.

In addition, there hasn't been a new console on the market for about six years, which has limited the buzz surrounding gaming. Nintendo plans to release its Wii U controller in mid-November, in time for the holiday shopping season.

However, some observers predict that the traditional sale of games on discs for use in consoles may be on its way out.

They say the key to gaming's future will depend on the creativity of smaller developers of downloadable games.

### Need a Battery? Just Spray It on

Rice University scientists have developed a spray-on battery that, they say, could be applied to almost



any surface. This technology could provide portable power to many devices that have trouble accommodating a traditional battery.

The new spray-on lithium-ion battery is applied via layers of paint. Each layer contains a necessary element of a conventional battery, including current collectors, a cathode, an anode, and a polymer separator. The separator keeps the positive and negative electrodes apart to avoid short circuits while permitting the transport of ionic charge carriers that complete the circuit.

Rice graduate student Neelam Singh led the research team that developed the spray-on battery.

To test their invention, the scientists performed an experiment in which they connected nine batteries sprayed onto bathroom tiles. One included a solar cell that converted power from a light. When fully charged by both the solar cell and standard building electricity, the batteries produced 2.4 volts and powered 40 LEDs that spelled out "Rice" for six hours.

The research team has also painted batteries onto surfaces such as stainless steel, flexible polymers, and glass.

Singh said spray painting is already a process used in many industries, so the technique will be easy for companies to implement.

The Rice team is continuing its research and hopes to develop versions of the battery that could include painted tiles that could be fitted together and configured in multiple ways to meet the needs of individual products and projects.

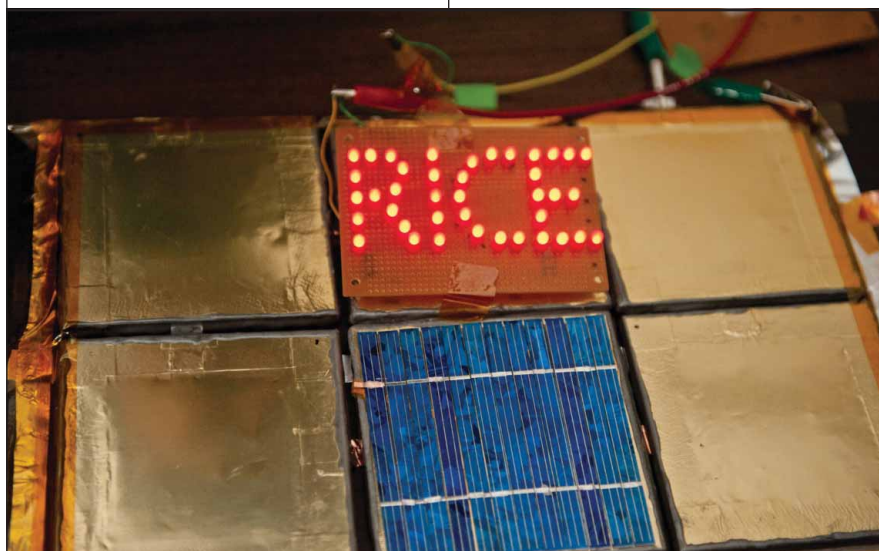

Rice University researchers have designed a technology for spraying batteries onto almost any surface. In one experiment, they connected nine batteries sprayed onto bathroom tiles. When fully charged, the batteries produced 2.4 volts and powered 40 LEDs that spelled out "Rice" for six hours.

## IPv4 Shortage Causes Address Trading, Hoarding

Some strange things are happening in the normally routine world of IP addresses, thanks to the growing shortage of IPv4 addresses.

For example, companies have begun participating in informal secondary markets in which they sell the addresses they don't need to organizations that don't have enough.

These developments are important because the vast majority of Internet traffic is still based on IPv4, despite growing calls over the last few years for IPv6 adoption in light of the shrinking number of available IPv4 addresses.

Within North America, about 25 percent of all new IPv4 address blocks that new users have obtained have been traded between organizations, according to a recent study by Syracuse University and Delft University of Technology researchers.

This trading has occurred even though the regional internet registry for North America, called the American Registry for Internet Numbers, still reportedly has millions of IPv4 addresses available for ISPs and users. Among other activities, the five RIRs manage the allocation and registration of IP addresses.

Traditionally, organizations return unneeded addresses to their area's RIR, which then gives them to organizations that want them.

However, that's not possible now in some regions. For example, two RIRs—the Asia-Pacific Network Information Centre and Réseaux IP Européens (European IP networks) Network Coordination Centre—are running out of IPv4 addresses.

Thus, organizations are trading addresses among themselves where such activity is permitted. They reportedly are trading for about \$10 each.

Meanwhile, the UK Department for Work and Pensions recently found a block of 16.8 million IPv4 addresses that are not connected to the Internet.

## UK TEAM BUILDS SUPERCOMPUTER FOR \$4,050

University of Southampton researchers, with the help of a professor's 6-year-old son, have built a supercomputer with a group of \$35, credit-card-sized Raspberry Pi computers stacked in racks built with Lego toy blocks.

The team—led by Professor Simon Cox—used 64 Raspberry Pi computers, each with a 16-gigabyte SD card, yielding a terabyte of memory—to construct their Iridis-Pi cluster. The machine was named after the University of Southampton's Iridis supercomputer.

Cox said one of his project's goals is to make supercomputing—typically the domain only of well-funded, highly trained scientists—accessible to hobbyists.

Raspberry Pi is a Linux-based, single-board computer with a 700-MHz ARM-architecture CPU, 256 Mbytes of RAM, two USB ports, and a 10/100 Ethernet controller. The 45-gram machine measures 85.6 × 53.98 × 17 millimeters, not including the SD card and connectors. The Raspberry Pi Foundation started work in 2009 to produce an inexpensive computer that young people could use to learn programming.

Cox and his team installed and built all of their supercomputer's software, including an implementation of the Message Passing Interface, a language-independent communications protocol used to program parallel computers. They also created code written in Python to distribute parallel-computing tasks.

Cox's 6-year-old son, James, lent his Lego-related expertise to the building of the racks that held the Raspberry Pi units.

The supercomputer cost about \$4,050, not including the Ethernet switches that connected the nodes.

The researchers have released an online guide ([www.southampton.ac.uk/~sjc/raspberrypi/pi\\_supercomputer\\_southampton.htm](http://www.southampton.ac.uk/~sjc/raspberrypi/pi_supercomputer_southampton.htm)) for building a Raspberry Pi-based supercomputer.



UK researchers have built an inexpensive supercomputer from a number of \$35, credit-card-sized Raspberry Pi computers. The team was led by Professor Simon Cox, whose 6-year-old son, James, designed the Lego racks that held the Raspberry Pi units.

However, the agency has decided to hold onto these addresses.

Sponsors of a public campaign are trying to fight this by convincing the UK government to auction off the block to users who want to use the addresses to link to the Internet.

Some observers say the addresses could be worth \$1.5 billion on the

open market, given that they comprise the last unused block of its size in the European-Middle East region.

## Researcher Cracks Encrypted Password for Flame-Botnet Server

A researcher with security vendor Kaspersky Lab cracked the encrypt-

## NEWS BRIEFS

tion protecting the password for a command-and-control server used by the Flame cyberespionage botnet, which infected and then compromised thousands of computers in the Middle East.

Having the password allowed security officials to access the server and learn more about Flame, as well as possibly identify its operators.

Kaspersky analyst Dmitry Bestuzhev broke the hash after security vendor Symantec failed to do so with brute-force attacks and asked for help. Symantec, the International Telecommunication Union's International Multilateral Partnership against Cyber Threats (ITU-IMPACT), and the German Federal Office for Information Technology Security's Computer Emergency Response Team for federal agencies (CERT-Bund/BSI) have been conducting an investigation into Flame.

Flame infected Windows computers and gave the resulting botnet's operators access to the machines. The software encrypted information on the computers and sent it to command-and-control servers for subsequent decryption offline.

Experts say Flame was highly sophisticated and was behind an April 2012 attack that caused Iranian officials to disconnect their oil-industry computers from the Internet.

The malware was discovered

in May and eventually executed a suicide command that wiped it off of infected machines. Many victims had already cleaned up their computers.

Nonetheless, security researchers say, information on command-and-control servers indicates the malware could strike again.

### Cyberattack on US Banks One of Biggest Ever

Recent distributed denial-of-service assaults on several major US banks represented one of the biggest such cyberattacks ever, according to security experts.

The DDoS attacks shut down websites belonging to Bank of America, Chase Bank, Wells Fargo, US Bank, Citibank, and PNC Bank after flooding them with huge amounts of traffic. The hackers didn't steal any data from the banks or damage their transactional systems.

To set up their attacks, the hackers compromised thousands of high-bandwidth web servers—not the PCs usually used in such assaults—via several DDoS tools, including a new one called itsoknoproblembro (It's OK, no problem, bro.). They used the resulting botnet to create traffic storms—based on the User Datagram Protocol, TCP, HTTP, and HTTP Secure—of up to 60 gigabits per second.

The attackers utilized multiple approaches—such as targeting routers, servers, and applications—to bring down the banks' websites. They switched the techniques around regularly depending on the results they were achieving and the defenses that targets deployed. In the past, security experts say, hackers have tended to use just one DDoS approach.

The assaults were particularly effective because by law, US banks must provide encryption, protected login systems, and other types of security. These applications are prone to bottlenecks, which make them especially susceptible to DDoS attacks.

The itsoknoproblembro tool can run on compromised servers even if the hackers can't acquire administrative or root access. This gives hackers more machines to work with.

Before most of the assaults, online posts correctly named the targets and the days they would be hit. However, experts say, they can't find information that supports claims in the posts that the Izz ad-Din al-Qassam Brigades, Hamas' military branch, were responsible.

And as intricate as the attacks were, security investigators add, there was nothing sophisticated enough to indicate that a country had to be behind them. They note that criminal organizations sometimes launch DDoS attacks on banks as a distraction while they steal money from account holders.

According to experts, administrators must better secure their web servers to keep attackers from being able to use their machines in DDoS attacks.

They also warn that the hackers could launch more of the same attacks.

# IEEE Intelligent Systems

THE #1 ARTIFICIAL INTELLIGENCE MAGAZINE!

IEEE Intelligent Systems delivers the latest peer-reviewed research on all aspects of artificial intelligence, focusing on practical, fielded applications. Contributors include leading experts in

- Intelligent Agents • The Semantic Web
- Natural Language Processing
- Robotics • Machine Learning

Visit us on the Web at  
[www.computer.org/intelligent](http://www.computer.org/intelligent)

Editor: Lee Garber, *Computer*;  
[l.garber@computer.org](mailto:l.garber@computer.org)

**Organizing Committee****Chair:**

H. Kobayashi Tohoku Univ.

**Vice Chairs:**J. Torrellas Univ. of Illinois,  
Urbana-Champaign

K. Uchiyama Hitachi

C. -M. Kyung KAIST

H. Amano Keio Univ.

**Advisory Chair:**

T. Nakamura Keio Univ.

**Secretaries:**

K. Suzuki Renesas

H. Igura NEC

**Treasurers:**

R. Egawa Tohoku Univ.

K. Nitta NTT

**Program Chairs:**

M. Ikeda Univ. of Tokyo

F. Arakawa Renesas

**Publicity Chair:**

M. Suzuki Panasonic

**Publication Chairs:**

Y. Uekawa Toshiba

Y. Hirose Fujitsu Labs.

**Registration Chair:**

K. Takano IBM

**Local Arrangement Chairs:**

Y. Nitta Renesas

A. Hashiguchi Sony

**Web Manager:**

Y. Sato JAIST

**Advisory Committee****Chair:**

T. Nakamura Keio Univ.

**Chair Emeritus:**

M. J. Flynn Stanford Univ.

**Advisory Emeritus:**

T. L. Kunii Univ. of Tokyo

**Members:**

D. Allison Stanford Univ.

D. B. Alpert Camelback  
Computer Architecture

A. J. Baum Intel

D. A. Draper True Circuits  
(TCMCOMP Chair)

M. A. Franklin Washington Univ.

Y. Hagiwara Sojo Univ./AIPS

S. Iwade Osaka Inst. of Tech.

L. Jow Hewlett-Packard

R. Kasai NTT Electronics

S. Kohyama Covalent Materials

T. Kunio NEC

K. Kushima NTT

T. Makimoto TechnoVision  
Consulting

O. Mencer Imperial College

H. Mochida Rohm

Y. Mori CM Engineering

J. Naganuma Shikoku Univ.

M. Nishihara AIPS

T. Nukii Sharp

T. Ogura Ritsumeikan Univ.

Y. Okamoto Panasonic

A. Omondi Yonsei Univ.

T. Shimizu Renesas

T. Tabata ON Semiconductor

T. Watanabe Riken

N. Woo Samsung

H. -J. Yoo KAIST

H. Yoshizawa Fujitsu Labs.

(in alphabetical order)

**IEEE Symposium on Low-Power and High-Speed Chips****COOL Chips XVI**

Yokohama Joho Bunka Center, Yokohama, Japan

(Yokohama Media &amp; Communications Center, Yokohama, Japan)

April 17 - 19, 2013

**CALL FOR CONTRIBUTIONS**

COOL Chips is an International Symposium initiated in 1998 to present advancement of low-power and high-speed chips. The symposium covers leading-edge technologies in all areas of microprocessors and their applications. The COOL Chips XVI is to be held in Yokohama on April 17-19, 2013, and is targeted at the architecture, design and implementation of chips with special emphasis on the areas listed below. All papers will be published online via IEEE Xplore. Authors of best papers will be recommended to submit an extended version to a COOL Chips special issue of IEEE Micro.

**Contributions are solicited in the following areas:**

- **Low Power-High Performance Processors for - Multimedia, Digital Consumer Electronics, Mobile, Graphics, Encryption, Robotics, Automotive, Networking, Medical, Healthcare, and Biometrics.**
- **Novel Architectures and Schemes for - Single Core, Multi/Many-Core, Embedded Systems, Reconfigurable Computing, Grid, Ubiquitous, Dependable Computing, GALS and Wireless.**
- **Cool Software including - Parallel Schedulers, Embedded Real-time Operating System, Binary Translations, Compiler Issues and Low Power Techniques.**

Proposals should consist of a title, an extended abstract (up to 3 pages) describing the product or topic to be presented and the name, job title, address, phone number, FAX number, and e-mail address of the presenter. The status of the product or topic should precisely be described. If this is a not-yet-announced product, and you would like to keep the submission confidential, please indicate it. We will do our best to maintain confidentiality. Proposals will be selected by the program committee's evaluation of interest to the audience. Submission should be made by e-mail, (Author's kit can be obtained from <http://www.coolchips.org/>)

to: M. Ikeda, Program Chair e-mail: [submit\\_xvi@coolchips.org](mailto:submit_xvi@coolchips.org)**Author Schedule: February 5, 2013 Extended Abstract Submission (by e-mail)****March 11, 2013 Acceptance Notified (by e-mail)****March 26, 2013 Final Manuscript Submission**

You are also invited to submit proposals for poster sessions by e-mail,

to: K. Hashimoto, Poster Chair e-mail: [poster\\_xvi@coolchips.org](mailto:poster_xvi@coolchips.org)**Author Schedule: March 18, 2013 Poster Abstract Submission (by e-mail)****March 26, 2013 Poster Acceptance Notified (by e-mail)**For more information, please visit <<http://www.coolchips.org/>>.For any questions, please contact the Secretariat <[cool\\_xvi@coolchips.org](mailto:cool_xvi@coolchips.org)>.

Sponsored by the Technical Committees on Microprocessors and Microcomputers and Computer Architecture of the IEEE Computer Society. In cooperation with the IEICE Electronics Society and IPSJ.

**Program Committee****Chairs:**

M. Ikeda (Univ. of Tokyo),

F. Arakawa (Renesas)

**Vice Chairs:**

J. Yao (NAIST),

H. Shimada (NAIST)

**Poster Chair:**

K. Hashimoto (Fukuoka Univ.)

**Special Session Chair:**

H. Tomiyama (Ritsumeikan Univ.)

**Members:**

A. Ben-Abdallah (Aizu Univ.)

A. Gupta (Freescale)

T. Harada (Yamagata Univ.)

S. Izumi (Kobe Univ.)

T. Kodaka (Toshiba)

G. Lee (Korea Univ.)

M. Muroyama (Tohoku Univ.)

S. Otani (Renesas)

H. Takizawa (Tohoku Univ.)

T. Tsutsumi (Meiji Univ.)

K. S. Yeo (NTU Singapore)

K. -R. Cho (Chungbuk National Univ.)

Y. Han (Chinese Academy of Science)

N. Higaki (Panasonic)

K. Kimura (Waseda Univ.)

Y. Kodama (Univ. of Tsukuba)

S. -J. Lee (Qualcomm)

B. -G. Nam (Chungnam National Univ.)

Y. Shibata (Nagasaki Univ.)

N. Togawa (Waseda Univ.)

Y. Wada (UEC)

Y. Inoguchi (JAIST)

T. Kobori (NEC)

M. Kuga (Kumamoto Univ.)

K. Morioka (Fujitsu Labs.)

K. Shimamura (Hitachi)

T. -H. Tsai (NCU Taiwan)

H. Yamauchi (Samsung)

(in alphabetical order)

(As of October 9, 2012)

## GUEST EDITOR'S INTRODUCTION

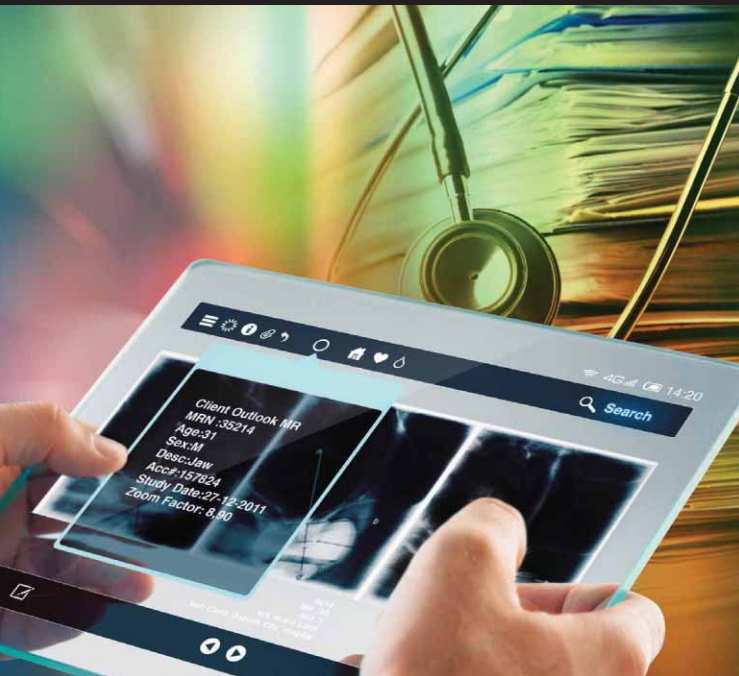

# The Move Toward Electronic Health Records

Ann E.K. Sobel, *Miami University*

**A multitude of projects are under way that support the transition to electronic health records, which enable the exchange of health information among healthcare-related parties while maintaining patient privacy and offering security protections.**

**T**he US Patient Protection and Affordable Care Act of 2010 embraces the notion that electronic health information is the bedrock of modern healthcare.

To this end, a multitude of projects are under way that support the transition to electronic health records (EHRs), which enable the exchange of information among various healthcare-related parties while maintaining patient privacy and offering security protections.

This ambitious endeavor with an aggressive timeline of milestones poses new and interesting problems pertaining to the sharing of private information among physicians, institutions, and individuals. Both the US Department of Health and Human Services and the National Institute of Standards and Technology have been actively supporting health IT projects and the creation of standards and certification.

Other countries have a head start on the US in this regard, as they began adopting related strategies years ago. Thus, some of the contributions to this special issue come from outside the US.

## IN THIS ISSUE

In his introduction to this special issue titled “Electronic Health Records: The HHS Perspective,” Doug Fridsma, chief science officer and director of the Office of Science & Technology in the US Department of Health and Human Services, gives an overview of current efforts to foster the meaningful use of EHRs. These efforts focus on developing a consensus for building standards and EHR certification, providing support to implementers, and focusing on patients’ needs to ensure ongoing success with the adoption of EHRs in the US.

In “Personal Health Records: New Means to Safely Handle Health Data?,” Inmaculada Carrión Señor and her colleagues at the University of Murcia, Spain, discuss concerns about the security and privacy of personal health information and explore the larger issue of segregating patient data in related health contexts. The authors describe the potential for addressing these concerns by combining a reliable certification entity that accredits data protection with the use of internationally established privacy and security standards and regulations to help increase the numbers of patients and medical professionals who are willing to use PHR systems.

“Electronic Case Records in a Box: Integrating Patient Data in Healthcare Networks” by researchers at Fraunhofer FOKUS, Germany, describes an interoperable solution to the efficient exchange of medical data between institutions. ECR in a Box, a concept deployed by Germany’s Electronic Case Record Association, hides the security and privacy



aspects so that healthcare providers and system vendors can focus on the business aspects of ECRs, thus providing an off-the-shelf approach that dramatically reduces entry barriers for healthcare providers and makes it easier to set up and participate in regional healthcare networks.

“Fusion: Managing Healthcare Records at Cloud Scale” by researchers from HP Labs proposes a cloud-based platform for low-cost delivery of healthcare applications that enables broader use of patient-centric management of EHRs while supporting the strict guidelines and technical safeguards required to protect information as outlined in the Health Insurance Portability and Accountability Act of 1996 (HIPAA) Privacy and Security Rules.

“Testing the Nation’s Healthcare Information Infrastructure: NIST Perspective” by Kevin Brady and his colleagues from the National Institute of Standards and Technology describes NIST’s involvement in healthcare automation activities focused on developing associated test methods, protocols, and specifications for interoperability in the use of EHRs.

In 2010, the initial goal of having 80 percent of physicians using EHRs by 2014 seemed optimistic given that less than 20 percent were using the technology at that time. However, according to a September 2012 survey of 21,000 physicians, 82 percent of respondents indicated that they are currently using an EHR or plan to do so ([www.healthcare-informatics.com/news-item/majority-physicians-currently-use-or-will-implement-ehrs-survey-finds](http://www.healthcare-informatics.com/news-item/majority-physicians-currently-use-or-will-implement-ehrs-survey-finds)). Fine-tuning certification criteria and establishing best practices appear to be keys to this initiative’s continued overall success. **C**

*Ann E.K. Sobel is an associate professor in the Department of Computer Science and Software Engineering, Miami University. Contact her at [sobelae@muohio.edu](mailto:sobelae@muohio.edu).*

**cn** Selected CS articles and columns are available for free at <http://ComputingNow.computer.org>.

TUESDAY, JANUARY 8 – FRIDAY, JANUARY 11, 2013 \* LAS VEGAS, NEVADA \* REGISTER AT [CESWEB.ORG](http://CESWEB.ORG)



PRODUCED BY  
CEA

When new ideas  
collide,  
the charge  
is unmistakable.



REGISTER NOW



## COVER FEATURE



# Electronic Health Records: The HHS Perspective

Doug Fridsma, *Office of the National Coordinator for Health IT*

**Electronic health records can deliver complete and accurate health information to patients and their providers, allowing better access to that information and, ultimately, empowering patients to take an active role in their healthcare.**

**T**he US Health Information Technology for Economic and Clinical Health (HITECH) Act, enacted as part of the American Recovery and Reinvestment Act of 2009, was signed into law on 17 February 2009 to promote the adoption and meaningful use of health information technology.

Electronic health records (EHRs) can provide many benefits for providers and their patients, but the benefits depend on how EHRs are used. Meaningful Use is the set of standards defined by the Centers for Medicare & Medicaid Services (CMS) Incentive Programs in conjunction with the Office of the National Coordinator for Health IT (ONC). These standards govern the use of EHRs and allow eligible providers and hospitals to earn incentive payments by meeting specific criteria.

The benefits of meaningfully using EHRs include delivering complete and accurate health information to patients and their providers, allowing better access to that information and, ultimately, empowering patients to take an active role in their healthcare.

## HEALTH IT GOALS

While developing the Meaningful Use standards and related federally managed health IT programs, the patient

has always remained ONC's sole focus. ONC sees the goals of promoting nationwide adoption of health IT as three-fold: improving health, providing better healthcare, and reducing costs.

To increase the overall health of the population, health IT can help address behavioral risk factors, focus on preventive care, and identify public health concerns, such as the increased risk of chronic illnesses like diabetes or acute illnesses like influenza. Providing better healthcare means improving patients' care experience within the Institute of Medicine's six domains of quality: safety, effectiveness, patient-centeredness, timeliness, efficiency, and equity. Finally, health IT should reduce costs by lowering the total cost of care while improving quality, resulting in reduced monthly expenditures for Medicare, Medicaid, and Children's Health Insurance Program beneficiaries.

In addition to supporting the widespread adoption of health IT, ONC is focused on developing standards that support interoperability and provide strong, clear guidance to the implementer community.

## MEANINGFUL USE: THE HITECH CORE

Implementation of Meaningful Use is occurring in three stages, emphasizing an incremental path that providers can take toward implementing EHR use in their practices or facilities.

In stage one, the focus is on making health information—usually maintained in paper records—electronic by implementing EHR use. In this stage, providers must demonstrate the ability to capture data in a standardized electronic format and then use that information to engage patients and their families during care.

In stage two, providers must be able to share records with other providers, regardless of the EHR systems in use. Ensuring that data is interoperable is a critical foundation to the successful use of health IT. Interoperability will improve patients' care by ensuring that their information follows them across different care settings.

Stage three will focus on improving information exchange and interoperability, building toward the day when healthcare providers can actually learn from the electronic information they are using. This stage will emphasize not only improving individual patient outcomes but also improving the health of the general population. This is Meaningful Use in action.

### WORKING IN THE BACKGROUND: IMPLEMENTATION

The work promoting the adoption and uptake of health IT is key to ensuring the HITECH Act's goals. But making certain that the technical standards and specifications needed to support this technology are in place is also critical to the development and success of a fully functional nationwide health IT ecosystem.

As with the technology that people use every day—telephones, email, the Internet, mobile technology—health information exchange doesn't offer a "one size fits all" solution—different providers will use the technology in different ways. The standards and specifications supporting these diverse needs are being developed and harmonized within ONC's Office of Science & Technology. Initiatives are under way to establish the fundamental building blocks of interoperability by

- standardizing healthcare vocabularies,
- leveraging HL7 international standards for interoperability of health information to develop the underlying structure,
- using secure email protocols to standardize transport,
- using NIST-adopted encryption standards to standardize security, and
- developing open and accessible APIs to standardize services.

ONC is working with the health IT community to convene and rapidly prioritize the challenges it faces so that it can subsequently develop and harmonize the standards, specifications, and implementation guidance needed to solve these challenges. ONC is also responsible for curating the set of standards and specifications that support interoperability and ensuring that they can be assembled into solutions for a variety of health information exchange scenarios. Through its Strategic Health IT Advanced Research Projects program and a series of Innovations Challenge grants, ONC will continue to support innovation in health IT.

A key component to ensuring success is providing support to on-the-ground implementers in assembling the standards and policy building blocks required to meet providers' most pressing information exchange needs. As early implementations produce results, disseminating and spreading the information exchange solutions will ensure that a wide array of implementation guidance is available to providers looking to engage in health information exchange.

### THE NEXT STEP: ENSURING STANDARDS COMPLIANCE

As the health IT community develops and agrees upon standards, ONC's Certification Program is intended to ensure that EHR technologies meet those standards and to help providers and hospitals achieve CMS's Meaningful Use objectives and measures.

Certification of health IT assures purchasers and other users that an EHR system offers the necessary technological capability, functionality, and security to help them meet Meaningful Use objectives and measures. Certification also gives providers and patients confidence that the products and systems they use are secure and can work with other systems to share information. To date, ONC has



**The first step toward widespread adoption of standards-based health IT is simply getting the systems in place and converting the data into an electronic format.**

certified many different types of ambulatory and inpatient EHR products from numerous vendors, providing this assurance throughout the country.

### WHERE ARE WE TODAY?

As of the end of 2011, 52 percent of office-based physicians indicated their intention to take advantage of EHR incentives ([www.cdc.gov/nchs/data/databriefs/db79.htm](http://www.cdc.gov/nchs/data/databriefs/db79.htm)). What's more, according to an ONC analysis of the National Ambulatory Medical Care Electronic Health Record Survey, the percentage of primary care providers who've adopted EHRs in their practice doubled from 20 percent to 40 percent between 2009 and 2011. These numbers are significant because the first step toward widespread adoption of standards-based health IT is simply getting the systems in place and converting the data into an electronic format.

Momentum is building. In terms of outreach, ONC's Regional Extension Centers (RECs) have signed up more than 100,000 primary care providers, meaning that roughly one-third of the nation's primary care providers have committed to meaningfully using EHRs by partnering with their local REC.

## COVER FEATURE

Hospital adoption of EHRs has more than doubled since 2009, increasing from 16 percent to 35 percent ([www.healthit.gov/media/pdf/ONC\\_Data\\_Brief\\_AHA\\_2011.pdf](http://www.healthit.gov/media/pdf/ONC_Data_Brief_AHA_2011.pdf)). In addition, approximately 85 percent of hospitals have indicated their intention to attest to Meaningful Use by 2015.

ONC will continue to support the community of stakeholders and the needs of patients. Functionality will continue to improve as the portfolio of standards building blocks grows in response to priorities that the health IT community sets forth. As this happens, ONC's certification program will also evolve to ensure that the country's health IT products conform to these agreed-upon standards. Finally, ONC will continue to support the community of implementers who are working to make interoperable EHRs a reality in our healthcare system.

**M**uch work remains to be done, but ONC is confident that the strategy of working within the community to build consensus on standards and EHR certification, providing education and support to implementers, and focusing on the patient's needs will ensure ongoing success with the adoption of EHRs in the US. **■**

*Doug Fridsma is the chief science officer and director of the Office of Science & Technology, Office of the National Coordinator for Health IT, US Department of Health and Human Services. In his role at ONC, Fridsma is responsible for the programs that focus on providing a foundation for interoperable health information exchange. He is a board member of HL7 and the National e-Health Collaborative. Fridsma received an MD from the University of Michigan and a PhD in biomedical informatics from Stanford University. Contact him at [doug.fridsma@hhs.gov](mailto:doug.fridsma@hhs.gov).*

## IEEE VR 2013

20th IEEE Virtual Reality

16-20 March 2013

Orlando, FL, USA

IEEE VR 2013 is the premier international conference and exhibition on virtual reality. Find the brightest minds, the most innovative research, the leading companies and the most stimulating discussions in the fields of virtual environments, augmented reality, haptics, and 3D user interfaces.

Register today!

<http://conferences.computer.org/vr/2013>
IEEE  computer society

## COVER FEATURE

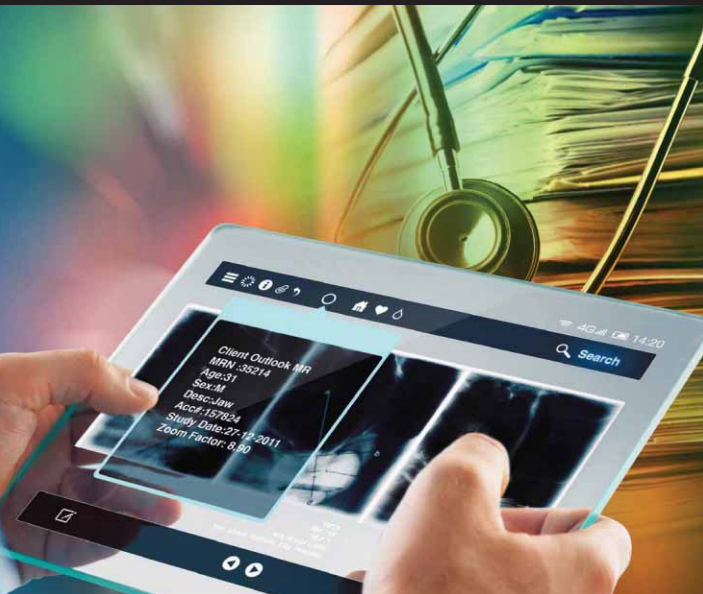

# Personal Health Records: New Means to Safely Handle Health Data?

Inmaculada Carrión Señor, José Luis Fernández Alemán, and Ambrosio Toval

University of Murcia, Spain

**Personal health records offer a way to manage health data while lessening healthcare costs, improving patient data quality, and fostering healthcare efficiency, but privacy and security issues are particularly important considerations for PHR designers.**

**T**oday's healthcare practices are increasingly transitioning to e-health: the application of information and communication technology (ICT) to health information systems. E-health offers solutions that respond to the burgeoning problems and demands inherent in the management of paper-based patient health records.

Regulations such as the 1996 US Health Insurance Portability and Accountability Act (HIPAA) state that patients have a right to control who can access their information and how that information is managed. This regulation, coupled with patients' interest in using the Internet to find information about their symptoms, diseases, and treatments, has led to the generation of personal health records.

A PHR is an electronic Web-based application that lets individuals access, manage, and share their health information and access that of others if they have the correct credentials. A typical PHR stores a variety of information beyond personal identification data:

- *personalized health advice*: from a physician on unhealthy habits, physical exercise, diet;

- *preferences*: types of treatment desired; stipulations regarding organ donations, hospice care, living will;
- *alarm system*: medication warnings, appointments with a physician, available analytical results; and
- *family history*: family diseases, genetic predispositions, if any.

In addition, a PHR stores vital information from the patient's healthcare providers: laboratory tests, medical images, allergies, glucose level, blood pressure, blood group, weight, height, immunizations, and medications.

PHR applications are increasingly popular. An estimated 70 million people in the US now access some form of PHR.<sup>1</sup> Users are aware of the benefits that PHRs provide, such as improved doctor-patient communication, ease of comprehension, and reduced risk of medical errors. Nonetheless, the existence of PHRs raises the possibility for significant privacy and security issues, which both users and designers must understand.

## PHR FUNCTIONALITY AND ARCHITECTURE

PHRs can store a wealth of user information that users can collect and manage. Patients can enter their data as well as view data from other sources. Patients can also share and exchange their data with other users and with healthcare professionals. Because information self-management lets patients better manage their own health data, users of PHRs specifically associated or integrated with their healthcare providers' data systems have found PHRs to be very helpful in health emergencies.<sup>1</sup>

## COVER FEATURE

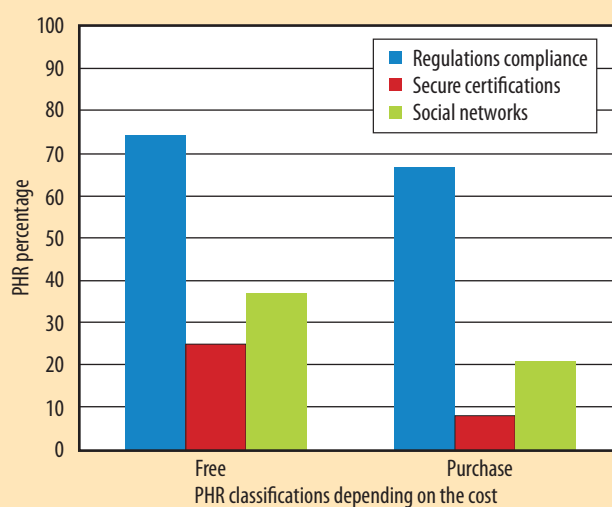

**Figure 1.** Personal health records (PHRs) in the communications hub between stakeholders who exchange data and interact with patients.

Many applications are integrated with, and use, PHRs as an information source, as Figure 1 shows. Examples of such applications are the electronic health record (EHR) systems of healthcare providers, the information systems of research labs and pharmacies, and monitoring devices.

An EHR is a repository of information related to a patient's healthcare history that is processed and supported electronically using ICT. An EHR differs from a PHR in that medical professionals, not patients, determine its contents. Healthcare professionals can support PHR-EHR integration because they can use PHRs to help patients manage their diseases, especially chronic conditions such as diabetes. Interoperability is a key component of PHR architecture that permits the integration of PHR and EHR systems. Standards like ISO/TS 13606 (*Health Informatics—Electronic Record Communication*) assist in the design of interoperable EHR systems.

As Figure 1 shows, the PHR receives data from patient monitoring devices, test results, EHR systems, doctors, and third-party applications (the last three obtain data from PHRs to perform their functions).

Business intelligence refers to computer-based techniques that identify, extract, and analyze business data, such as sales revenue from products or departments or from associated costs and incomes. PHRs could apply these techniques to extract the information that hospitals, pharmacies, insurers, research laboratories, and healthcare associations need. These entities could in turn use this information to discover what resources and data are needed to perform their activities. Furthermore, PHRs could help develop decision support systems for use in these scenarios. Finally, social networks are a communication bridge between PHRs and, as a last resort, patients.

## PHR ADOPTION

Although the adoption of PHRs, given their proliferation and wide availability, seems inevitable at this point, both doctors and patients have expressed several concerns:

- *Security on the Internet.* Web-based PHRs are subject to multiple threats, just like other Internet applications.
- *Privacy issues.* If patients control their PHRs, they must know to whom they are granting access and for what purpose.
- *Less information being recorded.* Physicians might avoid writing certain information for fear that patients can access that information.
- *Information quality.* If patients introduce their information into a PHR system, the information might not be as accurate as if a professional were to record it.
- *Comprehension difficulty.* Patients might be unable to understand the information contained in their PHR, leading to unnecessary anxiety. This problem could be exacerbated in patients with psychiatric problems.
- *Educational level.* Patients with a lower level of education might be unable to understand the information shared on the PHR system.
- *Decrease in face-to-face communication.* The use of PHRs involves the loss of face-to-face interaction between doctors and patients, the therapeutic relationships established by personal interaction, and associated benefits.
- *Increased workload and reduced compensation.* Physicians' workloads might increase, without appropriate remuneration, although most professionals believe that this increase might also lead to fewer patient visits.
- *Physicians' role.* It is unclear what the physicians' roles and responsibilities are with regard to PHRs.

These issues could well become barriers to the implementation and adoption of PHRs if not thoughtfully addressed by PHR designers.<sup>2</sup>

## PRIVACY AND SECURITY

One challenge when designing a PHR system is ensuring information privacy and security, which is a particular concern to users.<sup>3</sup> If patients lack confidence that their data is sufficiently protected, they will not use PHRs.

Beyond addressing security concerns, PHR designers must contend with legal requirements: many countries require personal data protection by law. European Union countries, for example, have developed personal data protection laws based on the 1995 European directive 95/46/CE. In the US, the security focus is sectorial, and laws such as the Privacy Act of 1974 guarantee the right

to information privacy. The “Personal Health Records and Security” sidebar offers additional information about these regulations.

Moreover, PHRs are subject to threats that are inherent in any Web application. The Open Source Vulnerability Database (OSVDB), for example, has registered 45,413 vulnerabilities to date ([www.osvdb.org](http://www.osvdb.org)) that are related to Web applications. These vulnerabilities—scored on the basis of impact, exploitability, temporal, and environmental vulnerabilities with the Common Vulnerability Scoring System (<http://nvd.nist.gov/cvss.dfm>)—have an average severity score of approximately 4.75 (out of 10). A score of 4.75 means that unauthorized people (usually hackers) could access and modify data relatively easily.

One example of a PHR that experienced data vulnerability problems is Microsoft HealthVault: in 2009, Microsoft identified 13 incidents that involved lost or stolen credentials and affected 15 individuals ([http://www.govinfosecurity.com/articles.php?art\\_id=2996&opg=1](http://www.govinfosecurity.com/articles.php?art_id=2996&opg=1)).

A suitable solution for achieving safer PHRs is to include privacy and security standards or regulations in the PHR early specifications that can readily be defined by, for instance, HIPAA, which identifies security and privacy rules that US health systems should satisfy. Additionally, the ISO/TS 13606 standard defines the minimum access policy specifications that EHR systems must satisfy if they are to be interoperable.

Various studies have evaluated PHR system privacy policies. For example, a 2011 study investigated whether a given set of PHRs satisfied the HIPAA rules.<sup>4</sup> In another study, researchers assessed the usability of privacy and security characteristics in PHR systems.<sup>5</sup> A 2012 study analyzed PHRs by function, dividing them into nine categories, depending on their security and privacy characteristics.<sup>6</sup> The “Privacy Policy Principles in PHRs” sidebar provides details regarding these policies.

It is possible to develop Web-based PHRs that can satisfy security certificates. This certification ensures that the data dealt with in the application are protected and encrypted, which lets consumers feel more confident when using such systems. Several online PHRs, such as dLife and HealthyCircles, are certified by entities such as TRUSTe ([www.truste.com](http://www.truste.com)).

Moreover, PHR designers should consider the Health on the Net Foundation Code of Conduct (HONcode; [www.hon.ch](http://www.hon.ch)) for Web-based records, as it is a code of conduct for medical and health websites that specifically addresses the reliability and usefulness of medical information on the Internet.

## PERSONAL HEALTH RECORDS AND SECURITY

**W**e analyzed 40 personal health record (PHR) application software packages, of which 16 are free and 24 are available commercially. Figure A shows the percentage of free and commercial PHR application software that satisfies security regulations or principles, such as the Health Insurance Portability and Accountability Act (HIPAA; [www.hhs.gov/ocr/privacy](http://www.hhs.gov/ocr/privacy)) and Health On the Net Code of Conduct (HONCode; [www.hon.ch](http://www.hon.ch)), has secure certifications, and is integrated with a variety of social networks.

In total, 70 percent of the PHR systems we analyzed satisfy some security regulations, 15 percent have one or more secure certifications, and 27.5 percent are connected with social networks. As Figure A shows, a higher percentage of free PHRs versus commercial PHRs satisfy these characteristics. Note, however, that we analyzed 33 percent more commercial than free PHRs. The total number of PHRs that actually satisfy regulations and secure certifications is quite high.

Medefile ([www.medefile.com](http://www.medefile.com)) is the most popular commercial PHR that we analyzed, with more than 18,000 fans on Facebook. Medefile satisfies HIPAA regulations and has been certified by both TRUSTe ([www.truste.com](http://www.truste.com)) and Geotrust ([www.geotrust.com](http://www.geotrust.com)). The most popular free PHR is dLife, specifically for diabetes patients ([www.dlife.com](http://www.dlife.com)), with more than 5,000 fans on Facebook alone. This PHR also satisfies HIPAA regulations and has the TRUSTe certification.

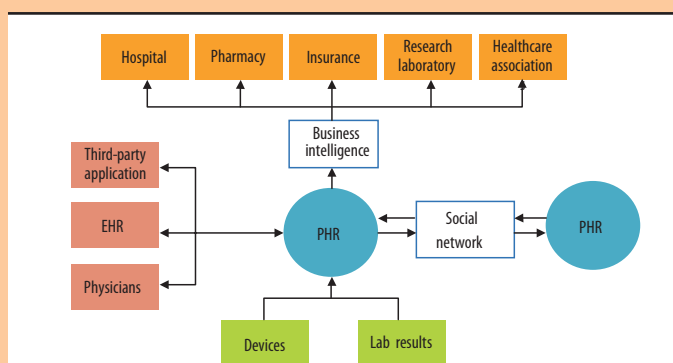

**Figure A. Free and commercial personal health record systems classified by regulation compliance, security certification, and social network integration.**

Privacy problems can result when, as is commonly the case, PHRs are used to analyze the data stored in them for research purposes. In these cases, the data is aggregated and de-identified—that is, data that has been purged of identification information that pertains to many people. However, it is very difficult to remove sufficient information to ensure that a specific person cannot be identified. Some studies have used methods such as k-anonymity to avoid this situation.<sup>7</sup>

Nevertheless, a new problem has arisen with the integration of PHRs and social networks—researchers Arvind Narayanan and Vitaly Shmatikov, for example, successfully identified a person from aggregated data and the person’s information that had been stored on a social network. Consequently, they developed a generic re-identification algorithm for anonymized social networks.<sup>8</sup>

## COVER FEATURE

## PRIVACY POLICY PRINCIPLES IN PHRS

**A** given PHR vendor or supplier's privacy policy contains all the information related to the privacy and security of user data. The privacy policy should be clear and concrete so that users can understand how the PHR system manages their information.

The Canadian Standards Association, for example, has defined 10 principles that privacy policies should satisfy to ensure that a particular system's privacy policy contains all the information the user needs. We performed a study using the seven most important principles defined by this association: consent, limiting collection, limiting user disclosures and retention, accuracy, safeguards, openness, and individual access. These principles are the only ones we could analyze as external auditors of PHR privacy policies.

We investigated to determine whether the privacy policies of the 23 free PHRs shown in Table 1 in the main text satisfy these seven principles.<sup>1</sup> The histogram in Figure B indicates the percentage of PHRs that satisfy 0, 1, 2, and so on, principles. Note that only 17.4 percent of PHRs satisfy all seven principles.

## Reference

1. G. Yee and L. Korba, "Personal Privacy Policies," *Computer and Information Security Handbook Canada*, J.R. Vacca, ed., Morgan Kaufmann, 2009.

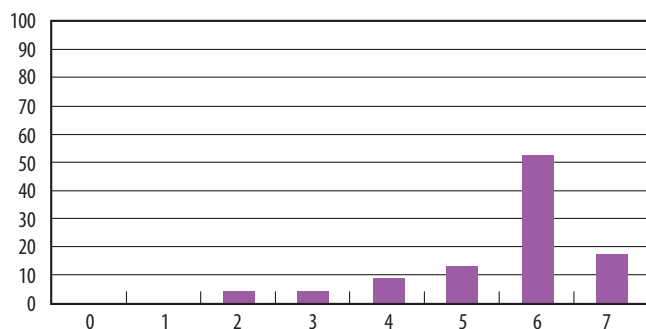

**Figure B. PHR histogram with policies that satisfy the privacy principles defined by the Canadian Standards Association.**

Still another situation that could potentially expose a person to data vulnerability is that administrative staff could access a user's data without receiving explicit consent.

In our work, we have researched PHRs in terms of availability, social network integration, and privacy policy. Table 1 lists 56 PHRs, both free and commercial, that we compiled both from a literature search and from the myPHR website ([www.mypHR.com](http://www.mypHR.com)), which was created and is managed by the American Health Information Management Association.

## ACCESS CONTROL AND AUDIT

As yet, unlike for EHRs, no international standard exists to define a PHR. The ISO/TS 13606 standard, for example, defines five sensitivity levels of information and identifies seven functional roles associated specifically with EHR system users. Each user has a functional role and can access the information depending on that role and the information's sensitivity level.

The role-based scheme defined by ISO for EHRs, however, can be adapted to PHRs, which are patient-centered applications and in which patients decide who can access what information. By analyzing 40 online PHRs against the backdrop of the ISO standard, we identified eight possible roles and permission assignments for seven access levels that PHR designers should consider in developing future PHRs. Table 2 lists these roles and permission assignments. Although the user ultimately decides who accesses what information and with what permission, the PHR system might suggest how to grant access. Moreover, because certain PHRs do not allow users to grant access, they might use this model.

A PHR system will manage varying roles, and offer different access levels, depending on its functionality. Administrator access allows another user to control and manage the information as if he or she is the user who owns it.

Certain PHR systems anticipate what happens if the user cannot access a PHR, as in the case of an emergency. In this situation, the individual would be unable to control who could access the data, but these PHR systems define a special role used only in these cases. Some systems do not grant access merely because someone says that an emergency has occurred, and some individuals would consider this to be a privacy breach. Other PHR systems use an audit log so that patients can see who has accessed their data, when the access occurred, and for what purpose. Both HIPAA and ISO/TS 13606 identify the need to use such logs.

HEALTH INFRASTRUCTURE:  
NEW APPLICATIONS

The integration of PHRs with social networks provides significant benefits—notably, patients with the same disease can contact each other to share information and experiences. For example, through dLife, a social network PHR that provides information specifically intended for diabetics, users can communicate with one another to share diabetes-related news and information. However, using social networking raises additional privacy and security issues with which PHR designers must wrestle, especially regarding the sharing of information related to family members.

Social networks have other pitfalls. Several PHRs, for example, currently offer patients the opportunity to provide genetic information. But a patient who voluntarily discloses this information through a social network could be violating a family member's privacy.



**Table 1. Availability and type of personal health records.**

Free	Social network	Privacy policy	PHRs
No	No	HIPAA or HONCode	EMRy STICK ( <a href="http://phr.emrystick.com">http://phr.emrystick.com</a> ); MedDataNet ( <a href="http://www.meddatanet.com">www.meddatanet.com</a> ); HealthString ( <a href="http://www.healthstring.com">www.healthstring.com</a> ); LifeOnKey ( <a href="http://www.lifeonkey.com/Solutions/Default.aspx">www.lifeonkey.com/Solutions/Default.aspx</a> ); Lynxcare ( <a href="http://www.lynxcare.net">www.lynxcare.net</a> ); HealthButler ( <a href="http://healthbutler.com">http://healthbutler.com</a> ); MediKeeper ( <a href="http://www.medikeeper.com">www.medikeeper.com</a> ); MyLifeSaver ( <a href="http://www.doctorglobal.com/index2.asp">www.doctorglobal.com/index2.asp</a> ); Your Health Record ( <a href="http://www.yourhealthrecord.com">www.yourhealthrecord.com</a> )
No	No	No	Patient Power ( <a href="http://gtipatientpower.com">http://gtipatientpower.com</a> )
No	No	Own	AccessMyRecords ( <a href="http://www.accessmyrecords.com">www.accessmyrecords.com</a> ); ER-IDcard ( <a href="http://www.er-card.com">www.er-card.com</a> ); HealthTracks ( <a href="http://www.healthtracks.com">www.healthtracks.com</a> ); HealthTrio ( <a href="http://www.healthtrio.com/index.php">www.healthtrio.com/index.php</a> ); K.I.S. Medical Record Solutions ( <a href="http://kis-medicalrecords.com">http://kis-medicalrecords.com</a> ); LifeLedger ( <a href="http://www.elderissues.com">www.elderissues.com</a> ); MedicalSummary ( <a href="http://www.medicalsummary.com">www.medicalsummary.com</a> ); MedNotice ( <a href="http://www.mednotice.com">www.mednotice.com</a> ); MyActiveHealth ( <a href="https://www.myactivehealth.com/portal">https://www.myactivehealth.com/portal</a> ); MyMedical Records ( <a href="http://www.mymedicalrecords.com">www.mymedicalrecords.com</a> ); myPHI ( <a href="http://www.my-phi.com">www.my-phi.com</a> ); OnlineMedicalRegistry ( <a href="http://www.myihr.com/entry">www.myihr.com/entry</a> ); PeopleChart ( <a href="http://www.peoplechart.com">www.peoplechart.com</a> ); EHE&me ( <a href="http://www.eheandme.com">www.eheandme.com</a> ); The Smart PHR ( <a href="http://www.thesmartphr.com">www.thesmartphr.com</a> ); WebMD Health Manager ( <a href="https://healthmanager.webmd.com">https://healthmanager.webmd.com</a> )
No	Yes	HIPAA or HONCode	Dossia ( <a href="http://www.dossia.org">www.dossia.org</a> ); Healthgram ( <a href="http://www.healthgram.com">www.healthgram.com</a> ); Magnus Health ( <a href="http://magnushealth.com">http://magnushealth.com</a> ); Medefile ( <a href="http://www.medefile.com">www.medefile.com</a> ); SynChart ( <a href="http://www.synchart.com">www.synchart.com</a> )
No	Yes	Own	MemiTech ( <a href="http://www.911medicalid.com">www.911medicalid.com</a> ); RelayHealth ( <a href="http://www.relayhealth.com">www.relayhealth.com</a> ); TAC Drive ( <a href="http://www.tacdrive.com">www.tacdrive.com</a> )
Yes	No	HIPAA or HONCode	GlobalPatientRecord ( <a href="http://www.globalpatientrecord.com">www.globalpatientrecord.com</a> ); MedicAlert ( <a href="http://www.medicalert.org">www.medicalert.org</a> ); MedsFile.com ( <a href="http://www.medsfile.com">www.medsfile.com</a> ); My HealthVet ( <a href="http://www.myhealth.va.gov">www.myhealth.va.gov</a> ); MediCompass ( <a href="http://www.medicompass.com/mcweb/default.aspx">www.medicompass.com/mcweb/default.aspx</a> ); MyChart ( <a href="http://www.mychartlink.com/mychart">www.mychartlink.com/mychart</a> ); Dr. I-Net ( <a href="http://www.drinet.com">www.drinet.com</a> )
Yes	No	No	Medical ID Card ( <a href="http://www.tnlink.com/medcard">www.tnlink.com/medcard</a> )
Yes	No	Own	iHealthRecord ( <a href="http://medfusion.net/ihealthrecord">http://medfusion.net/ihealthrecord</a> ); myHealthFolders ( <a href="https://myhealthfolders.com">https://myhealthfolders.com</a> ); TeleMedical.com ( <a href="http://www.telemedical.com">www.telemedical.com</a> ); MiVIA ( <a href="http://www.mivia.org">www.mivia.org</a> )
Yes	Yes	HIPAA or HONCode	My Doclopedia PHR ( <a href="http://www.doclopedia.com">www.doclopedia.com</a> ); Microsoft HealthVault ( <a href="http://www.microsoft.com/en-us/healthvault">www.microsoft.com/en-us/healthvault</a> ); dLife ( <a href="http://www.dlife.com">www.dlife.com</a> ); Juniper Health ( <a href="https://juniperhealth.com">https://juniperhealth.com</a> )
Yes	Yes	Own	HealthyCircles ( <a href="http://www.healthycircles.com">www.healthycircles.com</a> ); Keas ( <a href="https://keas.com">https://keas.com</a> )
Both	No	Own	myMediConnect ( <a href="http://www.mymediconnect.net/index.php">www.mymediconnect.net/index.php</a> ); Passport MD
Both	Yes	Own	NoMoreClipboard.com ( <a href="http://www.nomoreclipboard.com">www.nomoreclipboard.com</a> ); RememberItNow! ( <a href="http://www.rememberitnow.com">www.rememberitnow.com</a> )

Likewise, if a user who has contracted a disease at work—for example, after being exposed to chemicals—shares this information on a social network, the privacy of coworkers could be compromised. Another concern is information about contagious diseases—those closest to the patient might have the same illness, and their privacy would not be guaranteed.

As Figure 4 shows, PHRs such as Microsoft HealthVault have application programming interfaces (APIs) that software designers can use to create supplementary applications. PHRs can use these applications as a data source, like common health devices, which are connected to PHRs and thus make it easier for patients to upload and track health data. Conversely, because the applications can extract data from PHRs, they should likewise protect user data. PHRs such as HealthButler (<http://healthbutler.com>) and myMediConnect ([www.mymediconnect.net](http://www.mymediconnect.net)) share information with Microsoft HealthVault, which leads to a mutual sharing and complementing of both information stored by these PHRs and of functionality.

Microsoft HealthVault connects with third-party applications and devices. As Figure 4 shows, Micro-

**Table 2. Roles and possible permission assignments to decrease data vulnerability.**

Role	Access level functionality			
	View data	Add data	Modify data	Administrator
Owner/user	X	X	X	X
Friend	X			
Family member	X	X	X	X (only one family member)
Healthcare professional	X	X	X	
Other users	X			
Device <sup>1</sup>		X		
Application <sup>2</sup>		X		
Other services <sup>3</sup>	X	X	X	X

<sup>1</sup> Such as a blood pressure monitor, a weight, a blood glucose monitor.

<sup>2</sup> Such as DiabetesPHA, SmokeFreeLife, Lab Tracker by Health nexus.

<sup>3</sup> Insurance companies, pharmacies, and so on.

soft has registered 83 health tools and 20 health devices that are collectively classified into 10 activity categories.

## COVER FEATURE

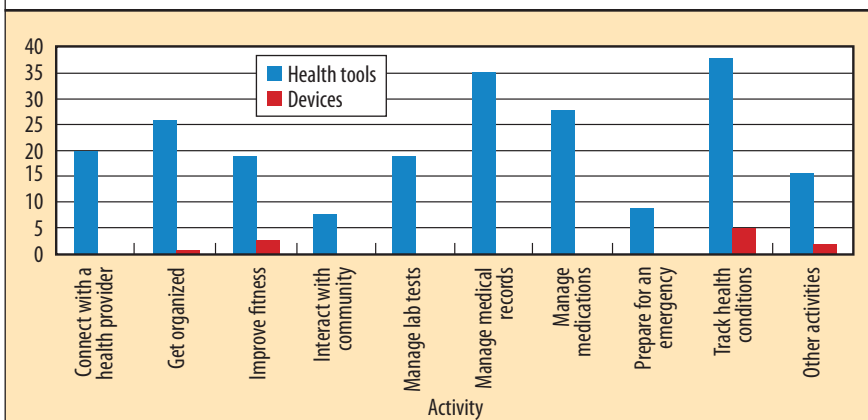

**Figure 4.** Health tools such as DiabetesPHA and devices such as a pedometer or blood pressure monitor that connect with Microsoft HealthVault are classified by activity.

## CLOUD COMPUTING

The use of PHRs with cloud computing provides new possibilities for designers. They could achieve PHRs quicker and with fewer mistakes, thus taking advantage of other PHRs stored in the cloud. However, this approach leads to new security and privacy threats that must be analyzed.

Microsoft HealthVault can be combined with Windows Azure capabilities, thus offering cloud computing services through its API. This API enables the development of applications for which the data source is Microsoft HealthVault. Some PHRs, like HealthATM (<http://healthatm.com>), have been deployed around Microsoft HealthVault to complement HealthVault's information and functionality, thus making it possible to design low-cost PHRs that are customized and optimized for specific functions and populations. Furthermore, third-party applications also use HealthVault as a storage service in the cloud. For example, Biomedix is an application that uses advanced natural language processing technologies to detect vascular diseases.

Designers of PHRs that offer cloud services must consider the potential for new security and privacy threats. New threats PHR designers face include the following:

- *Privileged user access.* Designers must consider that certain data will be processed outside their company.
- *Regulatory compliance.* Patients are responsible for the security and integrity of their own data, and they must verify that this data is safe.
- *Data location.* Data location is not precisely known with cloud services. Patients need to know whether providers satisfy some specific jurisdictions and what privacy requirements they satisfy.
- *Data segregation.* Data in the cloud is colocated with that of other customers, and cloud providers must use encryption schemes that take this special characteristic into account.

- *Recovery.* Cloud providers must have a data retrieval system, such as Iron Mountain (<http://www.ironmountain.com>), to recover data in the case of a disaster—for example, a cyberattack that results in massive data loss.

- *Long-term viability.* PHR designers must be sure that users' data will remain available even if the cloud provider disappears.

- *Network security.* All dataflow in the network must be secured to prevent the leakage of sensitive information. Encryption schemes such as Secure Sockets Layer could be used for this purpose.

- *Virtualization technology.* The dynamic nature of virtual machines permits fast reconfiguration and makes it possible to revert to previous instantiations, pause or restart, or clone and move the servers that create security problems.

- *Investigative support.* Investigating inappropriate or illegal activity can be very difficult in cloud computing. If designers meet to resolve national security and privacy requirements in the cloud, they can mitigate this problem.<sup>9</sup>

Achieving adequate security to deal with all these threats traditionally involves five aspects: availability, confidentiality, data integrity, control, and auditing. Availability is the property of being accessible and usable by an authorized entity on demand. Confidentiality ensures that information is accessible only to those authorized to have access. Data integrity ensures that information is accurate and not modified in an unauthorized fashion. Control access is a means of ensuring that only authorized users access data. Auditing ensures that any action can be examined later.

In addition to the potential they present for new business opportunities, PHRs are gaining increasing interest because of their ease of use, portability, and wide applicability. Currently, several million people around the world have access to some kind of PHR ([www.ncbi.nlm.nih.gov/pmc/articles/PMC2585530](http://www.ncbi.nlm.nih.gov/pmc/articles/PMC2585530)). However, problems with the privacy and security of such sensitive data could pose a serious impediment to PHR development.<sup>10</sup> The existence of a reliable certification entity, such as TRUSTe, that accredits data protection, along with the use of internationally established, well-regarded privacy and security standards and regulations such as HONcode,

ISO/TS 13606, and HIPAA, will help to increase the numbers of patients and medical professionals who are willing to use PHR systems.

In addition to the privacy and security issues that PHRs pose, the integration of technologies such as social networks is an ongoing area of research. Additionally, research is needed on the use of secure natural-language processing techniques to perform diagnoses and on machine learning to detect suspicious access to data.<sup>11</sup> 

## References

1. D.C. Kaelber et al., "A Research Agenda for Personal Health Records (PHRs)," *J. Am. Medical Informatics Assoc.*, vol. 15, no. 6, 2008, pp. 729-736.
2. G.L. Yau, A.S. Williams, and J.B. Brown, "Family Physicians' Perspectives on Personal Health Records: Qualitative Study," *Canadian Family Physician*, May 2011, pp. e178-e184.
3. P.C. Tang et al., "Personal Health Records: Definitions, Benefits, and Strategies for Overcoming Barriers to Adoption," *J. Am. Medical Information Assoc.*, Mar./Apr. 2006, pp. 121-126.
4. I. Carrión, J.L. Fernández-Alemán, and A. Toval, "Assessing the HIPAA Standard in Practice: PHR Privacy Policies," *Proc. 33rd Ann. Int'l Conf. Engineering in Medicine and Biology Soc. (EMBC 11)*, IEEE, 2011, pp. 2380-2383.
5. I. Carrión, J.L. Fernández-Alemán, and A. Toval, "Usable Privacy and Security in Personal Health Records," *Proc. Conf. Human-Computer Interaction (Interact 11)*, LNCS 6949, Springer, 2011, pp. 36-43.
6. I. Carrión et al., "Evaluation and Neuronal Network-Based Classification of the PHRs Privacy Policies," *Proc. Hawaii Int'l Conf. System Sciences (HICSS 12)*, IEEE, 2012, pp. 2840-2849.
7. L. Sweeney, "k-Anonymity: A Model for Protecting Privacy," *Int'l J. Uncertainty, Fuzziness and Knowledge-Based Systems*, vol. 10, no. 5, 2002, pp. 557-570.
8. A. Narayanan and V. Shmatikov, "De-Anonymizing Social Networks," *Proc. 30th Symp. Security and Privacy (S&P 09)*, IEEE, 2009, pp. 173-187.
9. E. Kuada, H. Olesen, and A. Henten, "Public Policy and Regulatory Implications for the Implementation of Opportunistic Cloud Computing Services for Enterprises," *Proc. 9th Int'l Workshop on Security in Information Systems*, pp. 3-13; [www.iceis.org/Abstracts/2012/WOSIS\\_2012\\_abstracts.htm](http://www.iceis.org/Abstracts/2012/WOSIS_2012_abstracts.htm).
10. I. Carrión, J.L. Fernández-Alemán, and A. Toval, "Are Personal Health Records Safe? A Review of Free Web-Accessible Personal Health Record Privacy Policies," *J. Medical Internet Research*, vol. 14, no. 4, 2012, p. e114.
11. A.A. Boxwala et al., "Using Statistical and Machine Learning to Help Institutions Detect Suspicious Access to Electronic Health Records," *J. Am. Medical Information Assoc.*, vol. 18, no. 4, 2011, pp. 498-505.

*Inmaculada Carrión Señor is an associate researcher in the Software Engineering Research Group in the Department of Computer Science and Systems at the University of Murcia, Spain. Her research interests include medical*

*informatics, software engineering, requirements engineering, and security and privacy. Carrión received a BSc in computer science from the University of Murcia. Contact her at [mariaainmaculada.carrion@um.es](mailto:mariaainmaculada.carrion@um.es).*

*José Luis Fernández Alemán is an associate professor of programming and software quality in the Department of Computer Science and Systems at the University of Murcia, Spain. His research interests include e-learning, software engineering, medical informatics, and computer-based learning and its application. Fernández received a PhD in computer science from the University of Murcia. Contact him at [aleman@um.es](mailto:aleman@um.es).*

*Ambrosio Toval is a full professor in the Department of Computer Science and Systems Department at the University of Murcia, Spain. His research focuses on the design and implementation of conceptual UML model verification, requirements engineering processes, computer-aided requirements engineering tools, and security requirements. Toval received a PhD in computer science from the Technical University of Valencia, Spain. Contact him at [atoval@um.es](mailto:atoval@um.es).*

 Selected CS articles and columns are available for free at <http://ComputingNow.computer.org>.

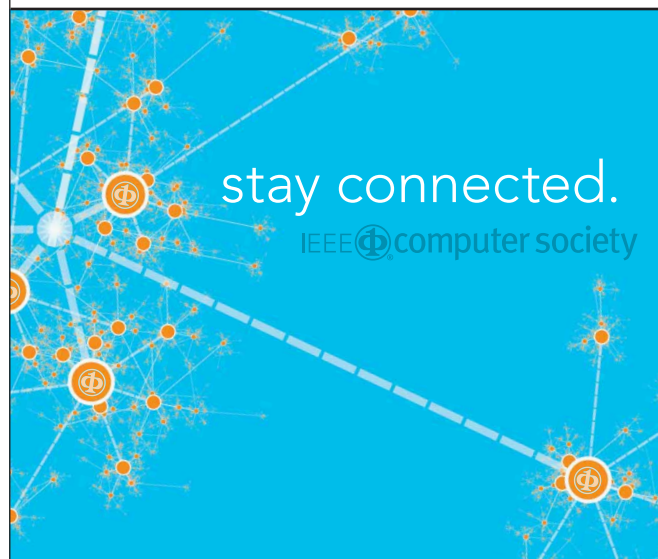

Keep up with the latest IEEE Computer Society publications and activities wherever you are.

 |

@ComputerSociety  
@ComputingNow

 |

facebook.com/IEEEComputerSociety  
facebook.com/ComputingNow

 |

IEEE Computer Society  
Computing Now

 |

[youtube.com/ieeecompstersociety](http://youtube.com/ieeecompstersociety)

## COVER FEATURE

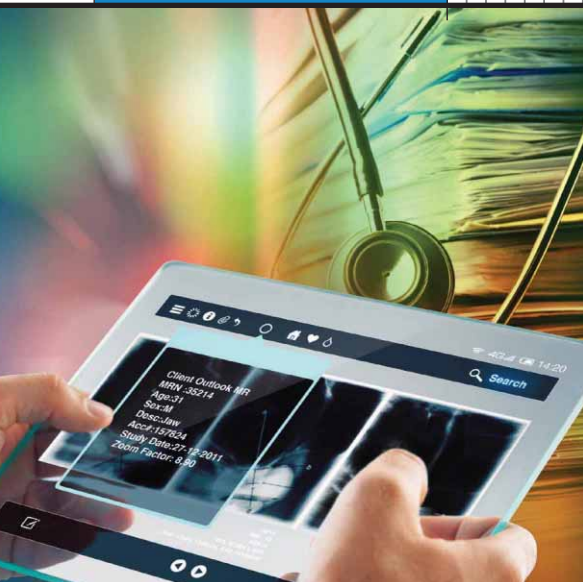

# Electronic Case Records in a Box: Integrating Patient Data in Healthcare Networks

Raik Kuhlisch, Ben Kraufmann, and Hannes Restel, *Fraunhofer FOKUS, Germany*

**An innovative deployment concept decouples document sources and electronic health records to provide an easy-to-use, seamless, yet secure platform for use in the cumbersome task of integrating an EHR platform into a regional healthcare network.**

**T**he reliable and confidential exchange of medical data is critical to making healthcare more efficient and cost-effective, while also protecting patient privacy. For this reason, healthcare providers are increasingly abandoning paper-based records in favor of electronic health records (EHRs) or electronic case records (ECRs). Laws recently enacted in many countries, such as the US Patient Protection and Affordable Care Act of 2010, encourage the development and use of EHRs/ECRs.

Due to the federated nature of EHRs/ECRs, security, privacy, and patient informed consent are key objectives. However, the complexity of state-of-the-art security architectures can make their integration with healthcare provider IT systems prohibitively expensive. Consequently, EHR/ECR providers must strive for innovative, cost-effective solutions.

In Germany, the Electronic Case Record Association—an interest group that includes major hospitals and clinics, local healthcare associations, and regional healthcare networks—has introduced a new deployment concept, ECR in a Box, that hides the security and pri-

vacancy aspects of ECRs so that healthcare providers and system vendors can focus on the business aspects. The approach's off-the-shelf nature dramatically reduces barriers to entry for healthcare providers, making it easier to set up and participate in regional healthcare networks.

## THE ECR PLATFORM

In 2006, major stakeholders in the German healthcare industry—later formally organized as the Verein Elektronische FallAkte (EFA), or Electronic Case Record Association—launched an initiative to create specifications for a federated and secure ECR service platform ([www.fallakte.de](http://www.fallakte.de)). The Fraunhofer Institute for Open Communication Systems FOKUS has since developed a reference implementation of the ECR platform that medical IT vendors Siemens, CompuGroup Medical, and the Computer Sciences Corporation's Healthcare Group use.

The ECR platform's primary goal is for all providers in the “circle of treatment,” including the general practitioner, clinical specialists, and therapists, to share a patient's medical data in a single case record during care for a particular injury, condition, or disorder—that is, “the case.” A case record is opened upon receipt of the patient's informed consent and closed upon the patient's full recovery or death. Closing a case record invalidates the informed consent and prohibits further access to the record by those in the circle of treatment. Because access is directly derived from the patient's informed consent, there is no need to define supplemental restrictions within the case record. The system grants the permissions to healthcare professionals based on their functional roles.

As Figure 1 shows, the ECR architecture defines a distributed peer-to-peer platform without central services. Each healthcare provider participating in the circle of treatment acts as an ECR peer. This implies that each participant must independently implement all ECR-related services—authentication, authorization, data storage, and so on. These implementations are based on the ECR service stack specification, which defines ECR peer connections to the local infrastructure and to other peers.

This federated healthcare environment includes distinct services (implemented as Web services), the ECR registry, the ECR repository, and the ECR consumer, all of which are managed by an ECR provider—typically a hospital. To enable an integrated viewpoint, the ECR provider fulfills the role of both data source and mediator: it operates one or more peers that both store medical data and return request results from other peers. All peers within the medical circle of treatment are likewise equal partners in a technical “circle of trust.”

## SECURITY ARCHITECTURE

Because security is a cross-cutting concern, the primary healthcare provider's ECR system incorporates a security architecture to ensure that only medical staff members with the patient's consent can access protected medical data. The security architecture's access control model combines discretionary access control (DAC), role-based access control (RBAC), and policy-based access control (PBAC). A white paper published by the nonprofit Integrating the Healthcare Enterprise (IHE) describes the underlying security principles in more detail.<sup>1</sup>

The communication among different clients and services as well as between the ECR services themselves occurs via synchronous end-to-end message exchange (unicast) in layer 7 of the Open Systems Interconnection (OSI) model. The generic communication pattern between two ECR peers is as follows:

- The client sends a request message to an ECR service and then pauses until service execution.
- The ECR service processes the request and executes the appropriate operation.
- The result is returned to the client, which then resumes its activities.

To guarantee maximum interoperability between the communicating ECR peers, the ECR architecture uses state-of-the-art standards for its messaging infrastructure—for example, SOAP and protocols such as WS-SecureConversation to establish security contexts across messages,<sup>2</sup> WS-Trust for trusted message exchange,<sup>3</sup> and

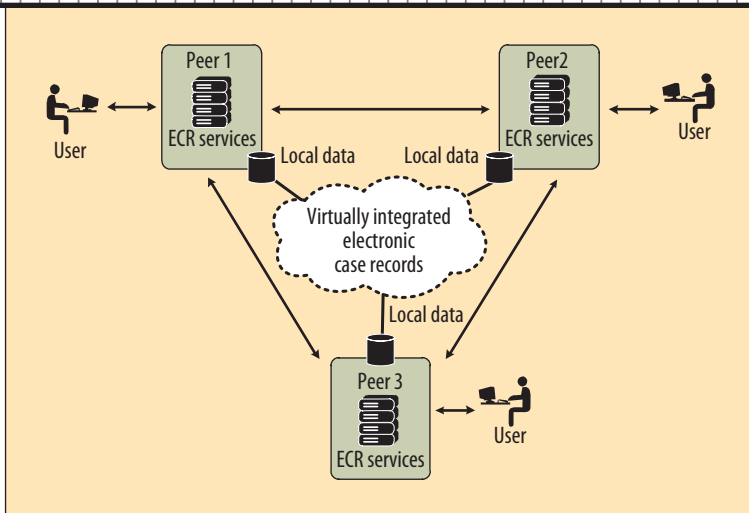

**Figure 1. Distributed peer-to-peer architecture of the Electronic Case Record Association's ECR platform. Each provider participating in the circle of treatment acts as an ECR peer, independently implementing all ECR-related services.**

WS-SecurityPolicy for the description of a service's security requirements.<sup>4</sup>

The security architecture is completely independent of the application/business architecture. Security tokens—specifically, digitally signed SAML assertions<sup>5</sup>—are transferred solely in the SOAP security header, just as the WS-Security standard specifies,<sup>6</sup> even for proxy solutions deployed behind XML gateways. As Figure 2 shows, the ECR architecture applies several security mechanisms to protect medical data. This includes authentication and authorization at the service layer, and subsequently the pseudonymization of the stored data. Furthermore, each of the ECR services' related stored data is technically separated to prevent prohibited data aggregation, such as data mining and data fusion.

The security architecture relies on a completely decentralized processing paradigm that takes authentication for granted. Each peer uses an identity provider to authenticate healthcare professionals via X.509 certificates. Identity providers establish trust by issuing the identity assertions that a service consumer uses to demand access to service providers. In the ECR case, this identity assertion contains the authenticated healthcare professional's attributes that might be relevant for retrieving a patient's records. The client application subsequently passes the returned assertion and a patient identifier to a cryptographic service provider. This admission token service creates secret hashes for each healthcare professional attribute concatenated with a patient identifier.

In this peer-to-peer approach, the authentication assertion is forwarded to any other peer that calculates secret hashes as well. Admission codes are created for each peer and returned to the client application in a second

## COVER FEATURE

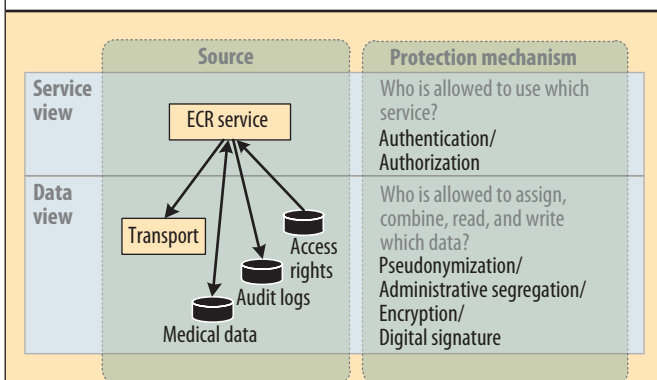

**Figure 2.** ECR architecture approaches to protect medical data.

SAML assertion—the admission assertion collection—that contains further admission assertions from each peer. This approach enables pseudonymization because the relationship between the healthcare professional and the patient is secret: a patient identifier is not needed when working on a case record.

A peer's registry service retrieves case records from both the local data store and the respective registry service of the trusted peers.

Each registry service returns those records that comply with the admission codes assigned to it. For a healthcare professional to browse a case record's contents, create folders, or request medical data, the service request must contain an authorization. Following the principle of using security tokens with separated concerns, a second authorization service must issue another SAML (named access assertion) by passing a selected case record identifier and an admission assertion to that authorization service. The access assertion has one or more assigned access policies that express the access rights that the ECR business services must enforce. The ECR provider must determine whether the assignment needs an explicit access policy. In such a case, either a client application (policy push) or an ECR business service (policy pull) might request an optional policy assertion with an XACML policy set and enforce it accordingly.<sup>7</sup> To guarantee confidentiality, each ECR peer's document repository encrypts all medical documents before the system transmits them to the client.

### ECR IN A BOX

The above-described ECR platform provides interfaces for both outpatient and inpatient care. But to function properly in both domains, the underlying technical architecture must maintain interoperability between the office-based and hospital-based IT systems. Integration with primary healthcare IT systems is essential for the platform's overall acceptance, but this might be limited

by high costs in terms of both time and money. Related concerns include the following:

- The implementation and deployment of state-of-the-art security architectures is not a strong business area for most hospital IT vendors. Given the fact that hospitals with a long history of systems integration often deal with vendor lock-in, this could lead to conflicts.
- The business processes that occur throughout a health record's life cycle are unique in different healthcare networks.
- Hospitals and physicians usually implement unique IT infrastructures.
- Each of the numerous established vendors of clinical information systems provide their own interfaces and capabilities. Health Level Seven International (HL7), a global organization, writes consensus-based healthcare communication standards. Some vendors support standards-based business process control via HL7 v2 messages that can be exchanged between different clinical information systems.

The ECR's deployment of business and security services aims for a tight integration between the hospital information system (HIS) and its supporting clinical workflows. A "boxed" implementation of the ECR has been developed by Fraunhofer FOKUS to offer a highly integrated ECR solution that supports an easy integration into existing HISs and that encapsulates security aspects and issues. Accomplishing this requires a proprietary interface between the HIS and the ECR service stack—that is, vendors must provide customer-specific ECR solutions that individually integrate with HIS subsystems.

### Integrating services

Because developing customer-specific ECR solutions can be difficult or even infeasible for some vendors, ECR in a Box addresses these concerns. The platform includes the following:

- ECR application services come preloaded with security services and privacy-enhancing technologies to hide complexity from both the provider (the hospital) and the client (the physician). Simple programming and webservice interfaces on the client side and a standards-based retrieve, locate, and update service (RLUS) interface on the provider side are likewise predefined. Vendors can revert to original interfaces as needed.
- As Figure 3 shows, ECR plugs are the glue between the RLUS interface and the HIS. Since HL7 v2 messages are predominantly used in hospitals, ECR plugs transform those messages into clinical document architecture (CDA) documents and vice versa.<sup>8</sup> Most healthcare information systems encode new or

updated medical documents in the medical document management (HL7 v2 MDM) format; they encode all patient-related, administrative events (admit, transfer, discharge, and so on) in the admit discharge transfer (HL7 v2 ADT) format. ECR plugs are easy to implement with the communication servers that link HIS subsystems. Additionally, ECR in a Box provides ECR plugs for most common identity and access management systems as well as IHE cross-enterprise document sharing (XDS) systems.

ECR in a Box handles a case record's life-cycle management as well as its contents. The platform is loaded with special HL7 CDA documents that are used as controlling objects to create and update case records, thereby easing plug and play. In fact, ECR in a Box's innovation is that it handles file management through CDA documents. This approach is similar to the document engineering approach, in which the exchanged documents control the underlying business process.<sup>9</sup> This moves ECR life-cycle management from the HIS to the ECR platform.

A CDA content module is a template for a specific HL7 v3 CDA entity such as a document, section, or entry. The specified ECR modules are based on IHE PCC (patient care coordination) CDA content modules, in which CDA documents are profiled for their conformance to special templates.<sup>10</sup> Table 1 lists several CDA content modules specified for ECR in a Box.

We focus here on the two most widely used individual content modules—extracting and updating documents.<sup>11</sup> ECR extract documents are used for two purposes and thus come in two variations:

- ECR providers use *initial extract documents* to create documents, such as the initial case record extract document, which they can send to ECR in a Box to set up a new ECR instance.
- Healthcare professionals use *vital extract documents* to query ECR in a Box for a given object's vital extract document, which the platform uses to process an ECR or a visit's current content or state.

ECR update documents update object properties of visits and case records. ECRs have two defined update content modules because consent and authorization updates

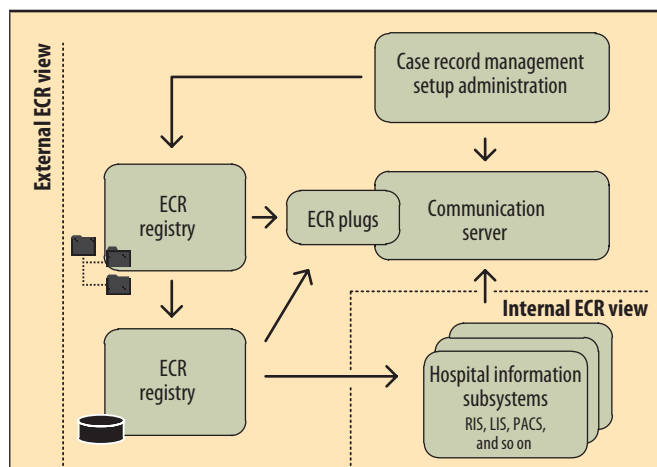

**Figure 3. Connecting ECR to hospital information systems subsystems.**

require special handling as opposed to “generic” updates:

- Healthcare professionals use *case record update content modules* to update the case record itself, that is, to upload new documents such as diagnostic findings.
- *Consent update content modules* update patient informed consent. ECR in a Box directly infers access rights from these consent documents.

Information object or document metadata cannot be updated; if modifications are needed, the client simply sends a new document to ECR in a Box. Just as sent HL7 v3 CDA documents represent operation instructions (“initialize new case record,” “read data,” “put new data”), the exact inbound and outbound provider interface must be defined for the CDA's controlling documents. Consequently, ECR in a Box's server-side face must provide an interface for querying against the information models inside the box as well: case management and medical data are commonly governed by the HIS, not the ECR platform.

The inbound/outbound provider interface typically uses the following operations:

- *initialize*—send new information objects to ECR in a Box;

**Table 1. ECR document content modules.**

Module	Case record	Healthcare professional (HCP) visit	Information object
Extract document	Initial case record extract content module	Initial HCP visit extract content module	Wrapped non-CDA content module
	Vital case record extract content module	Vital HCP visit extract content module	
Update document	Case record update content module	HCP visit update content module	
	Consent update content module		

## COVER FEATURE

- *put*—send updated information objects to ECR in a Box; and
- *list*—fetch one or more information objects from ECR in a Box.

Every operation has defined request and response messages that carry information to and from ECR in a Box. To initialize, maintain, and use the core structural objects found in case records, ECR in a Box accepts messages that comply with the RLUS service functional model specification.<sup>12</sup>

The ECR-specific inbound/outbound provider interface supports a core subset of the functionalities defined in the RLUS specification; specifically, ECR in a Box requires HL7 v3. Additional ECR plugs that convert messages in



**ECR in a Box provides a highly integrated software or hardware solution that supports easy integration into existing HISs and encapsulates security features.**

outdated formats might support older HL7 versions. Using HL7 messages to couple the ECR with the internal IT infrastructure requires mapping the internal record structure to the ECR structure. This is accomplished by means of semantic signifiers.

### Semantic signifiers

Medical and administrative data transferred between ECR in a Box and ECR plugs must be described both semantically and structurally:

- For interoperability with RLUS services, a classification and description of the returned data must be available to enable its further processing.
- Requested data from ECR in a Box must be identifiable and transferable in an appropriate return type. The return type does not necessarily need to be the same as the storage type, but its requestors should have defined it.
- Ideally, search requests and filters should not be aligned against generic metadata but rather against specific information models.

The RLUS specification provides a flexible means of querying data. So-called semantic signifiers specify the RLUS messages that ECR in a Box processes, defining the syntax and semantics of the data that is to be exchanged via the message: with semantic signifiers, a service provider can make statements about the message's content and structure that should be com-

municated, similar to a service description in WSDL documents. A semantic signifier's essential elements include its name, its description, and a normative data structure that describes instances of it—for example, implementation guidelines, schemas, and specifications for validation.<sup>13</sup>

As the term implies, a specific semantic signifier establishes a specific view on the stored ECR data in an ECR data back end. The “filling” of a semantic signifier—its instantiation—with medical data relates to the system's ability to interpret the data. Generally, two types of systems identify the extent to which an RLUS implementation can interpret medical data:

- A *content agnostic* implementation cannot interpret the data. This is analogous to an IHE XDS.b document repository, in which a document from an inquiring system—say, an XDS.b document consumer—is retrieved solely by using a document identifier. A system behaves similarly when the data is encrypted and must be decrypted by a third party. To allow a search on such data (content independent), metadata must be associated with it.
- In contrast, content-aware systems can interpret or analyze a database. These systems are characterized by data that is collectable and transferable into a return type defined by a semantic signifier. In other words, complex queries for specific data are possible. Data warehouse systems with data mining and online analytical processing have this capability. Medical ontologies might also be used.

Although ECR in a Box currently processes a handful of information types—see the ECR content modules in Table 1—future implementations should be able to return aggregated data.

### Off-the-shelf deployment

ECR in a Box provides a logical combination of technical components that can be used for both software and hardware implementations. For example, Fraunhofer FOKUS implements the ECR in a Box concepts using an XML gateway to offer

- service virtualization,
- dataflow control,
- event and access attempt auditing,
- integrity verification and confidentiality enforcement on exchanged data, and
- integrated hardware modules.

Going forward, additional ECR implementation could be virtualized using XML gateways, such as the ECR application architecture or metadata management.



The client-side counterpart of ECR in a Box is the ECR connector. Just as ECR in a Box facilitates the integration of HIS subsystems, the ECR connector simplifies the connection of client-side systems. As Figure 4 shows, the ECR Connector implements various webservice security mechanisms defined by ECR specifications, transparently setting up secure ECR in a Box sessions via WS-SecureConversation and handling all security tokens such as authentication and authorization for service invocations. It is not necessary for a physician's desktop system to process ECR security-related tokens because the ECR connector encapsulates that task.

The ECR connector can be used both as a software library and as a hardware box with a SOAP interface. Other approaches for using the ECR connector incorporate a Web-distributed authoring and versioning (WebDAV) interface or printer drivers with text recognition. For example, HL7 CDA referral letters might be used as an active control object to create a new case record. Additionally, to register the document, the physician's desktop system can upload it into special WebDAV folders or it can print them via a virtual printer, which might be necessary if the primary HIS does not support direct document export.

### A COMPARISON

The ECR is primarily a German construct for which there is no comparable system in most countries. The ECR platform is dedicated to regional health networks with the purpose of better treatment for patients receiving care from various healthcare providers. In Germany, information exchange among health information organizations is subject to regulation and very restricted. Thus, the case record has a dedicated use and a limited set of users. From the data protection perspective, the ECR concept is widely accepted because no queries on stored data reveal the entirety of a patient's data. Only a limited set of users who have received consent can retrieve case records. This separates the ECR from other sharable EHR approaches,

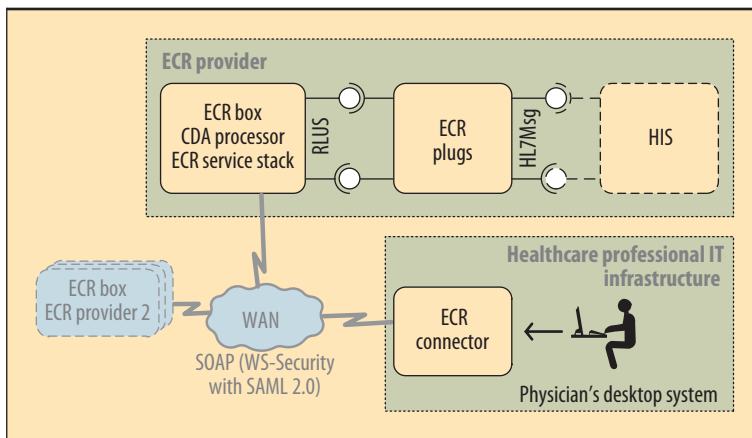

**Figure 4.** ECR in a Box and the ECR connector serve as enablers for a secure and trustworthy data exchange between HIS and a resident physician's IT.

such as those used in the US or other countries in Europe.

In the US, the Nationwide Health Information Network (NHIN), now called eHealth Exchange, created a specification for a messaging platform that allows health-related information exchange. The NHIN and ECRs share the same architectural principles, such as decentralization, local autonomy, and service orientation. Both specifications also rely exclusively on open standards. Table 2 highlights other similarities and differences.

**Table 2. Comparison of the US Nationwide Health Information Network and Germany's ECRs.**

Feature	NHIN	ECRs
<b>Audience</b>		
Healthcare consumer	X	--
Healthcare provider	X	X
Purpose of use	General health information	Strictly case-related
<b>Services</b>		
Pseudonymized records	--	X
Patient/record discovery	X/--	--/X
Query for available documents	X	X
Retrieve documents	X	X
Health information event messaging	X	--
Document-based control	--	X
<b>Security</b>		
Webservice-based message security	X	X
Authorization framework	X	X
Federated health information exchange (federated identity)	X	X
Requester authorization	X	X
Policy-based access control	X	X
System security categorization	Moderate	High
Audit trail	X	X

## COVER FEATURE

Currently, ECR in a Box has proved to be valuable on the ECR provider side, but future work will focus on enabling physicians on the client side to make semantic queries via the ECR connector. This will increase the quality of communicated data and demonstrate the advantages of using a content-aware system at the document level.

Other work also must be done on secure rendering of case records when using mobile devices, which is becoming increasingly more common in the medical field. Fraunhofer FOKUS is likewise investigating emerging Web security trends such as JSON data structures<sup>14</sup> and associated JSON security profiles (addressing signatures and encryption) and their suitability for the ECR security architecture. Thus, JSON simplifies and enables the usage of mobile devices and establishes a second, secured communication protocol next to SOAP. **■**

## References

1. J. Caumanns et al., "IHE IT-Infrastructure White Paper, Access Control," IHE Initiative, Sept. 2009; [www.ihe.net/Technical\\_Framework/upload/IHE\\_ITI\\_TF\\_WhitePaper\\_AccessControl\\_2009-09-28.pdf](http://www.ihe.net/Technical_Framework/upload/IHE_ITI_TF_WhitePaper_AccessControl_2009-09-28.pdf).
2. A. Nadalin et al., "WS-SecureConversation 1.3," Oasis, 2007; <http://docs.oasis-open.org/ws-sx/ws-secureconversation/200512/ws-secureconversation-1.3-os.html>.
3. A. Nadalin et al., "WS-Trust 1.3," Oasis, 2007; <http://docs.oasis-open.org/ws-sx/ws-trust/200512/ws-trust-1.3-os.html>.
4. A. Nadalin et al., "WS-SecurityPolicy 1.2," Oasis, 2007; <http://docs.oasis-open.org/ws-sx/ws-securitypolicy/200702/ws-securitypolicy-1.2-spec-os.html>.
5. J. Kemp et al., "Authentication Context for the OASIS Security Assertion Markup Language (SAML) v2.0," Oasis, 2005; <http://docs.oasis-open.org/security/saml/v2.0/saml-authn-context-2.0-os.pdf>.
6. A. Nadalin et al., "Web Services Security: SOAP Message Security 1.1," Oasis, 2006; [www.oasis-open.org/committees/download.php/16790/wss-v1.1-spec-os-SOAPMessageSecurity.pdf](http://www.oasis-open.org/committees/download.php/16790/wss-v1.1-spec-os-SOAPMessageSecurity.pdf).
7. "eXtensible Access Control Markup Language (XACML) v2.0," Oasis, 2005; [http://docs.oasis-open.org/xacml/2.0/access\\_control-xacml-2.0-core-spec-os.pdf](http://docs.oasis-open.org/xacml/2.0/access_control-xacml-2.0-core-spec-os.pdf).
8. Corepoint Health, "The HL7 Evolution Comparing HL7 Version 2 to Version 3, Including a History of Version 2," white paper, 2010; [www.corepointhealth.com/sites/default/files/whitepapers/hl7-v2-v3-evolution.pdf](http://www.corepointhealth.com/sites/default/files/whitepapers/hl7-v2-v3-evolution.pdf).
9. R. Glushko and T. McGrath, *Document Engineering: Analyzing and Designing Documents for Business Informatics and Web Services*, MIT Press, 2005.
10. "Patient Care Coordination," IHE Wiki, July 2012; [http://wiki.ihe.net/index.php?title=Patient\\_Care\\_Coordination](http://wiki.ihe.net/index.php?title=Patient_Care_Coordination).
11. "IG:CDA für die elektronische Fallakte," HL7 Wiki, Mar. 2012; [http://wiki.hl7.de/index.php/IG:CDA\\_f%C3%BCr\\_die\\_elektronische\\_Fallakte](http://wiki.hl7.de/index.php/IG:CDA_f%C3%BCr_die_elektronische_Fallakte).
12. "Retrieve, Locate, and Update Service (RLUS) Specification, v.1.0.1," OMG, July 2011; [www.omg.org/spec/RLUS/1.0.1/pdf](http://www.omg.org/spec/RLUS/1.0.1/pdf).
13. "ISO/IEC 19757-3:2006 Information Technology—Document Schema Definition Language (DSDL)—Part 3: Rule-Based Validation—Schematron," Int'l Org. for Standardization, Jan. 2010; [www.iso.org/iso/iso\\_catalogue/catalogue\\_tc/catalogue\\_detail.htm?csnumber=40833](http://www.iso.org/iso/iso_catalogue/catalogue_tc/catalogue_detail.htm?csnumber=40833).
14. D. Crockford, "The Application/JSON Media Type for JavaScript Object Notation (JSON), RFC 4627," IETF, 2006; <http://tools.ietf.org/html/rfc4627>.



## IEEE Open Access

Unrestricted access to today's groundbreaking research  
via the IEEE Xplore® digital library

## IEEE offers a variety of open access (OA) publications:

- Hybrid journals known for their established impact factors
- New fully open access journals in many technical areas
- A multidisciplinary open access mega journal spanning all IEEE fields of interest

► Discover top-quality articles, chosen by the IEEE peer-review standard of excellence.

Learn more about IEEE Open Access  
[www.ieee.org/open-access](http://www.ieee.org/open-access)



**Raik Kuhlisch** is a researcher at Fraunhofer FOKUS, where he works on IT security and Semantic Web technologies related to healthcare issues. Kuhlisch received an MS in computer science from the University of Hagen, Germany. Contact him at [raik.kuhlisch@fokus.fraunhofer.de](mailto:raik.kuhlisch@fokus.fraunhofer.de).

**Ben Kraufmann** is a researcher at Fraunhofer FOKUS. His research interests include IT security in distributed systems and XML technologies. Kraufmann received a diploma in computer science from the Free University of Berlin, Germany. Contact him at [ben.kraufmann@fokus.fraunhofer.de](mailto:ben.kraufmann@fokus.fraunhofer.de).

**Hannes Restel** is a researcher at Fraunhofer FOKUS. His research interests include interoperability, IT security, and the Semantic Web. Restel received an MS in computer science from the Free University of Berlin, Germany. Contact him at [hannes.restel@fokus.fraunhofer.de](mailto:hannes.restel@fokus.fraunhofer.de).

## ORGANIZING & PROGRAM COMMITTEES

### General Chair

Jie Wu, Temple University

### Program Chair

John Douceur, Microsoft Research

### Program Vice Chairs

#### Algorithms and Theory

Faith Ellen, University of Toronto, Canada

#### Security and Privacy

Cristina Nita-Rotaru, Purdue University

#### Fault Tolerance and Dependability

Roy Friedman, Technion, Israel

#### Wireless, Mobile, Sensors, and Ubiquitous Computing

Yu-Chee Tseng, National Chiao-Tung University, Taiwan

#### Big Data, Data Management, & Analytics

David Du, University of Minnesota

#### Cloud Computing and Data-Center Systems

Manuel Costa, MSR-Cambridge, UK

#### P2P, Distributed OS, and Middleware

Jon Howell, MSR-Redmond

#### Web-based Systems and Applications

Aleksandar Kuzmanovic, Northwestern Univ.

#### Energy Management and Green Computing

Ricardo Bianchini, Rutgers University

Krishna Kant, National Science Foundation

#### Crowdsourcing, Social Networks, and Reputation Systems

Zhi-Li Zhang, University of Minnesota

### Program Committee Members

(Please see the conference web page)

### Workshops Co-Chairs

Hai Jin, Huazhong Univ. of Science and Technology, China

Ivan Stojmenovic, Univ. of Ottawa, Canada

### Awards Co-Chairs

Matt Mutka, Michigan State Univ.

Mukesh Singhal, UC-Merced

Wei Zhao, Univ. of Macau, Macau

### Local Arrangements Chair

Chiu C. Tan, Temple University

### Registration Chair

Carrie Stein, Ohio State University

### Finance Chair

Dong Xuan, Ohio State University

### Publicity Chairs

Leszek Lilien, Western Michigan Univ.

Pedro M. Ruiz, Univ. of Murcia, Spain

Guojun Wang, Central South Univ., China

### Publication Chair

Feng Li, IUPUI

### International Liaison Co-Chairs

Chita Das, Penn State University

Michel Raynal, IRISA-IFSIC, France

Makoto Takizawa, Seikei University, Japan

### TCDP Chair

Jiannong Cao, Hong Kong Polytechnic Univ., HK

### Steering Committee Chair

Xiaodong Zhang, Ohio State University

# CALL FOR PAPERS

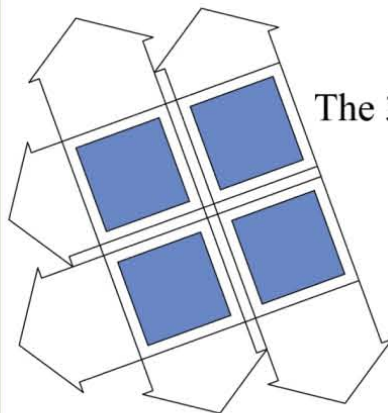

## ICDCS 2013

The 33rd International Conference on

# Distributed Computing Systems

Philadelphia, USA

July 08-11, 2013

<http://www.cis.temple.edu/icdcs2013>



Sponsored by

The IEEE Computer Society Technical Committee on Distributed Processing

### SCOPE

The conference provides a forum for engineers and scientists in academia, industry and government to present their latest research findings in any aspects of distributed computing. Topics of particular interest include, but are not limited to:

Algorithms and Theory

Security and Privacy

Fault Tolerance and Dependability

P2P, Distributed OS, and Middleware

Wireless, Mobile, Sensors, & Ubiquitous Computing

Web-based Systems and Applications

Big Data, Data Management, & Analytics

Cloud Computing and Data-Center Systems

Energy Management and Green Computing

Crowdsourcing, Social Networks, & Reputation Systems

NOTE: To build a broad program and to encourage a diverse set of submissions, a limited number of papers will be accepted within each topic area, and every topic area will accept a minimum quota of papers.

### WORKSHOPS

There will be 8 workshops and 1 tutorial held in conjunction with the conference. Please refer to the conference web page for details. For additional information, please contact the respective workshop organizers or the workshops co-chairs Prof. Hai Jin ([hjin@hust.edu.cn](mailto:hjin@hust.edu.cn)) and Prof. Ivan Stojmenovic ([ivan@site.uottawa.ca](mailto:ivan@site.uottawa.ca)).

### PAPER SUBMISSION

*Form of Manuscript:* All paper submissions should follow the IEEE 8.5" x 11" Two-Column Format. Each submission can have up to 10 pages; papers exceeding this limit may be rejected without review. If the paper is accepted for publication, up to 2 over-length pages may be purchased for the final camera-ready version. Submitted papers should NOT be blinded for review.

*Electronic Submission:* Submissions will be handled via the conference web page.

### IMPORTANT DEADLINES

Paper Submission

Author Notification

Final Manuscript Due

**November 12, 2012**

**February 25, 2013**

**March 25, 2013**

For further information, please contact General Chair, Prof. Jie Wu at [jiewu@temple.edu](mailto:jiewu@temple.edu) or Program Chair, John Douceur, at [johndo@microsoft.com](mailto:johndo@microsoft.com)

## COVER FEATURE



# Fusion: Managing Healthcare Records at Cloud Scale

Sujoy Basu, Alan H. Karp, Jun Li, James Pruyne, Jerry Rolia, Sharad Singhal, Jaap Suermondt, and Ram Swaminathan, *HP Labs*

An experimental open, cloud-based platform for large-scale, low-cost delivery of healthcare applications enables broader use of patient-centric management of electronic health records and facilitates the secure and seamless sharing of EHRs among stakeholders within a healthcare system.

**H**ealthcare forms a large and growing segment of the world economy,<sup>1</sup> and providers are under significant pressure to reduce costs by introducing automation, which has led to a focus on the deployment of electronic health records (EHRs). The Health Information Technology for Economic and Clinical Health (HITECH) Act, part of the American Recovery and Reinvestment Act (ARRA) of 2009, is an example of how governments are increasingly providing incentives for healthcare providers to move toward using EHR systems in patient care.

In many settings, small-scale providers are typically a patient's first point of contact with a healthcare system. The use of EHRs in these settings is thus essential to achieving the technology's oft-touted benefits. However, the substantial IT cost and expertise required to implement such systems has limited their adoption.

Cloud-based platforms are ideally suited for delivering IT applications because they offer substantial scalability, agility, and cost advantages. However, EHR applications

have stringent requirements because of the sensitive nature of the data involved, business-critical demands, regulatory constraints, and the need to securely and seamlessly share data among multiple parties including healthcare providers, payers, government agencies, and patients.

Fusion is an experimental open, cloud-based platform for securely managing and sharing healthcare information at large scale that aims to reduce the cost of adopting EHRs. It also offers new opportunities to develop applications that can leverage EHR data to improve quality of care, healthcare efficiency, and treatment outcomes.

## FUSION FEATURES AND BENEFITS

Figure 1 shows the Fusion platform's scope. Small clinics, hospitals, payers, and other stakeholders in a healthcare system interact with Fusion to upload or access data for patient care and potentially for research. Service interfaces provide access for developers to create new applications and link EHR systems to exchange data.

### Features

Fusion has several key features.

**Low cost and large scale.** Fusion is architected to scale horizontally to keep costs low for the cloud service provider, healthcare providers, and patients. Given that EHR applications are business critical, the platform is also designed to be highly available and reliable.

**Secure data protection.** Patient data must be stored securely and protected for a very long time. The Fusion architecture includes mechanisms to enable security,

privacy, and auditability of accesses to medical records.

#### Seamless, decentralized data sharing.

Disparate healthcare providers can use Fusion to directly store patient records and securely share this data with other stakeholders. Fusion also supports the integration of EHR environments that store data in their own formats, and provides mechanisms to allow managed sharing of aggregated data.

**Patient empowerment.** Patients can use Fusion to view their own EHRs, regardless of which provider generated them, and grant access to all relevant members of the healthcare team managing their treatment.

### Benefits

Fusion provides multiple benefits to stakeholders.

**Patients.** Fusion monitors patients' complete health history, improving their quality of care and treatment outcomes. It also protects patient privacy by controlling the release of medical data, ensuring that such data has not been subject to unauthorized use. And with Fusion, patients have anytime, anywhere access to their health records.

**Providers.** Fusion enables on-demand, real-time access to health data and aggregated knowledge derived from such data, resulting in better treatment decisions and facilitating collaboration among providers during treatment. It also contains mechanisms to ensure compliance with regulatory requirements using a common, secure platform that supports best practices. Individual healthcare IT departments can thus avoid the cost of duplicating the necessary enforcement infrastructure while demonstrating appropriate use of healthcare data when disputes occur. Fusion reduces the risk to the provider of releasing data by managing access to centrally stored records, rather than transferring copies of the records themselves.

**Payers.** Patients and providers can use Fusion to securely and efficiently grant access to medical records such as procedures, tests, clinical notes, and prescriptions for claim adjudication, accelerating claims processing while ensuring claim integrity and preventing errors.

**Developers.** Fusion provides open APIs that developers can use to create, integrate, and provision existing and new applications and services that conform to Fusion's security and privacy protection standards.

### ARCHITECTURAL REQUIREMENTS

Fusion's innovative approach to managing and sharing healthcare data addresses significant technical and adop-

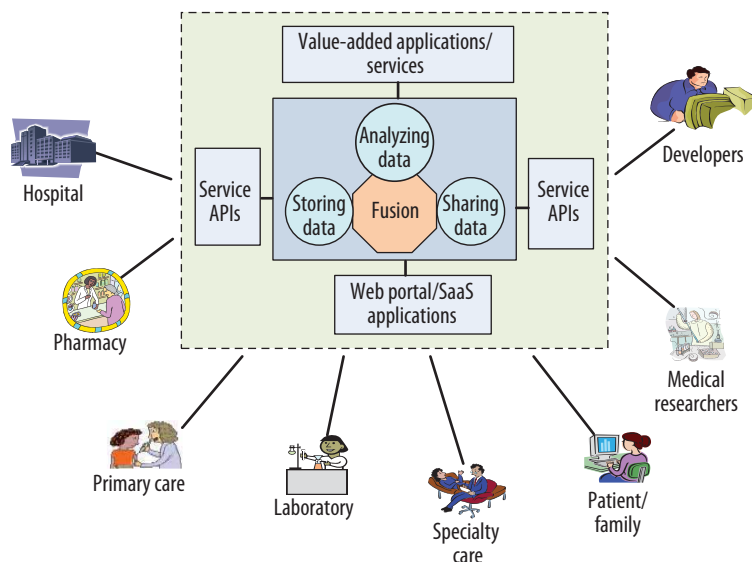

**Figure 1. Fusion platform.** Stakeholders within a healthcare system interact with Fusion to upload or access data for patient care and potentially for research. Service interfaces provide access for developers to create new applications and link EHR systems to exchange data.

tion hurdles that healthcare IT systems face when opting for a cloud-based EHR solution.

### Cloud-based delivery model

The cloud-based delivery paradigm is inherently a volume model that relies on shared resources to drive down cost. To encourage wide adoption, Fusion must scale out horizontally while keeping operational costs low. The platform is designed to handle up to 1 billion patients, 10 million practitioners, and 100 billion or more individual health records, with an affordable cost per patient and per provider. In practice, depending on the scale and trust model assumed in the implementation, Fusion could be used in public, private, or hybrid clouds.

### Balance of security, privacy, and ease of data sharing

Health records contain extremely sensitive personal information and thus pose strong privacy concerns. Any EHR system must comply with various regulatory policies regarding the handling of such information. In the US, for example, the Health Insurance Portability and Accountability Act (HIPAA) and the HITECH Act define strict guidelines and specify the technical and methodological safeguards required to protect medical data.

Different stakeholders must be able to use Fusion to leverage common security and privacy protection technology, best practices, and knowledge offered by the cloud service provider to meet compliance requirements. At the same time, healthcare practitioners need lightweight, transparent, and trustworthy mechanisms to share data

**COVER FEATURE**

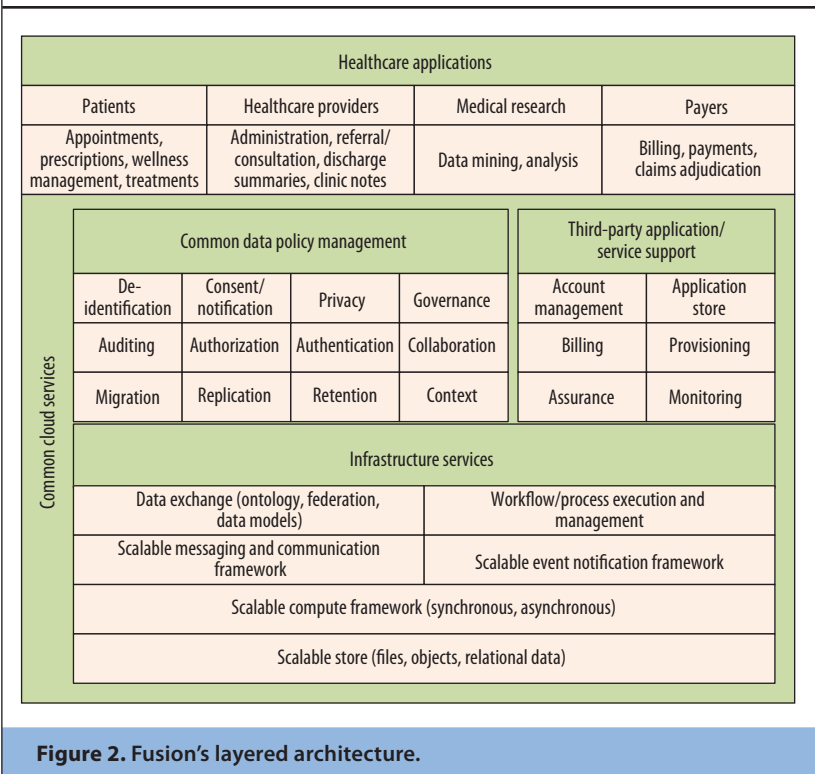

**FUSION ARCHITECTURE**

Figure 2 shows Fusion's layered architecture.

The infrastructure layer contains building blocks such as a store for health records; a messaging and communications framework for interactions among healthcare providers; a compute framework for processing data management tasks, including data encryption, data retention, and data analyses; and a workflow execution and management mechanism to manage cross-provider, process-driven collaboration. These building blocks are available in most public, private, or hybrid cloud offerings, or developers can build on them using appropriate software components.

Above the infrastructure layer, Fusion contains a common data policy management layer, where the system handles issues including authorization, authentication, access control, auditing, data retention, and consent/notification for privacy protection. Be-

cause regulations and cloud models vary widely,<sup>2,3</sup> the policies in this layer must be specific to the geographic region or type of cloud environment where Fusion is deployed. We assume that covered entities (such as doctors) will act in accordance with existing security requirements, regulatory policies, and best practices. While Fusion does not address all aspects of regulatory compliance, such as administrative requirements, it provides a common platform to capture best practices and share them across users.

Also above the infrastructure layer, Fusion exposes functions such as billing, provisioning, and discovery as service APIs with developer tools to support the easy integration of various third-party healthcare-specific applications. We envision Fusion as a next-generation platform for existing EHR vendors as well as for novel applications that leverage Fusion's capabilities to assist medical researchers, payers, and regulatory bodies.

Finally, Fusion's domain application layer integrates EHR applications targeted at patients, providers, payers, researchers, and other stakeholders.

Our research focuses on the common data policy management layer. In particular, this layer has two main subsystems: the *Fusion Store*, for large-scale secure management of EHRs to support regular patient care; and the *Fusion Data Share*, for aggregating de-identified data to support applications such as healthcare analytics, peer-comparison studies, and research that require sharing data more broadly across the healthcare system.

**Figure 2. Fusion's layered architecture.**

without compromising security and privacy. Furthermore, security mechanisms must not interfere with normal clinical workflows.

**Collaborative data sharing**

The Fusion architecture must facilitate a collaborative environment where participating healthcare providers can seamlessly share data and best practices while respecting patients' preferences and consent policies. To enable evidence-based medicine and take advantage of derived common knowledge, it must allow for the consolidation of de-identified patient information across providers to support analytics applications.

**Patient centricity**

All healthcare data related to a given patient should be accessible to that patient, regardless of its origin. At the same time, patients should not need to be involved in day-to-day decisions about sharing data among providers. Thus, Fusion should provide direct value to patients while also being easy for healthcare practitioners to use.

**Openness to third-party service providers**

Given the high degree of fragmentation among stakeholders in a healthcare system, the service platform should have the flexibility to allow organic growth as needed by accommodating applications from diverse third-party application developers. In other words, Fusion should have an open and not a monolithic closed architecture.

## SECURE HEALTH DATA MANAGEMENT

Central to the Fusion architecture is the need to securely and efficiently store patients' health records and to enable sharing them in accordance with regulatory policies and the consent and notification requirements of individual providers and patients.

The Fusion Store combines cloud-based data storage with data encryption and authorization-based access control<sup>4</sup> to provide a highly secure and privacy-protected environment to manage EHR data. Fusion's data access protocols provide patients with the ability to access all of their own health records, as well as to authorize others to access their records, while allowing providers to easily and securely share data without the patient's constant participation or intervention.

### Protecting data at rest

The Fusion Store uses a record-oriented data organization scheme in which each data record is encrypted with a unique key. Encryption keys also serve as authorization tokens, thus allowing a person (or application) that has the keys to create or read the corresponding records. A patient's records are linked together using metadata arranged as a tree hierarchy that is also encrypted. The Fusion Store uses a journaling mechanism<sup>5</sup> to make metadata and data records immutable and appends new metadata and data records during updates.

As Figure 3 shows, the metadata tree's first two levels represent patients and providers, while the leaves contain pointers to the actual data records as well as the keys used to encrypt and decrypt the data records. *Lockboxes* on each node of the metadata tree store the encryption keys. The lockbox itself is encrypted using the key stored in the parent's lockbox. For example, the lockbox at  $N_6$  is encrypted using  $L_2$ . The Fusion Store uses this lockbox's content—that is,  $K_6$ —to encrypt the lockbox at node  $N_8$ . Thus, given a key to node  $v$ 's lockbox, one can decrypt the lockbox's contents and recursively use these contents to access encryption keys for  $v$ 's children.

### Secure key management and delegation

The Fusion Store uses a novel approach to managing encryption keys and delegating access to data records. Each provider owns and manages a subtree between the metadata tree's root and leaves. In Figure 3, for example, provider  $P_1$  owns and manages the subtree rooted at  $N_1$ . Thus, a provider can selectively share patient records with other providers by sharing the lockbox keys in its subtree.

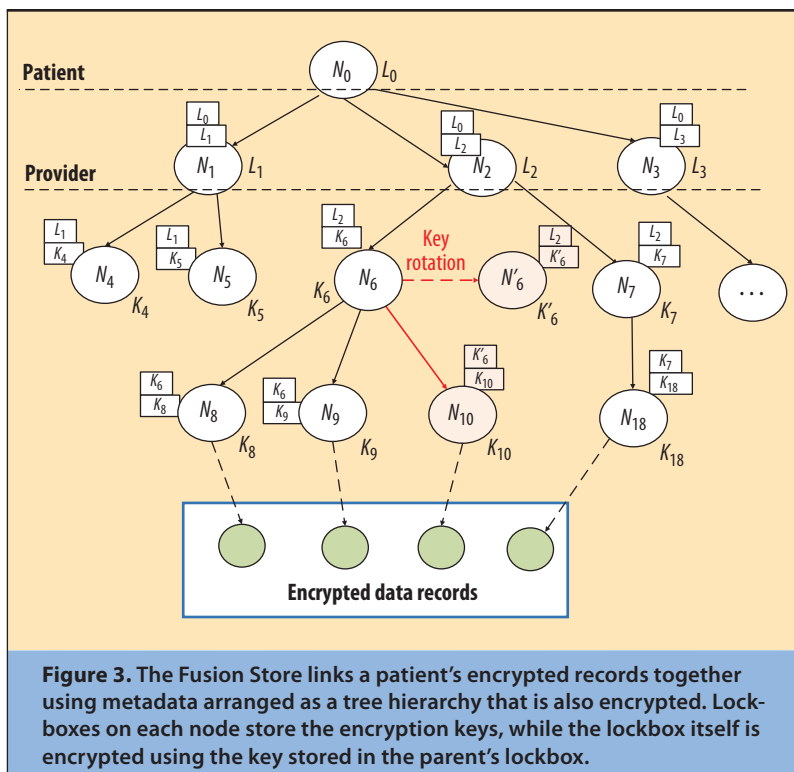

**Figure 3.** The Fusion Store links a patient's encrypted records together using metadata arranged as a tree hierarchy that is also encrypted. Lockboxes on each node store the encryption keys, while the lockbox itself is encrypted using the key stored in the parent's lockbox.

**Setup.** Each patient maintains a root secret  $L_0$ , possibly stored on a secure personal device such as a smart card. When visiting a provider  $P_i$ , the patient presents the secure device as part of the process of registering with  $P_i$ , which in turn generates a provider-specific shared secret  $L_i$  that is derived from  $L_0$  and unique to  $P_i$ . In Figure 3, for example,  $P_i$  could derive  $L_i$  for  $i = 1, 2, 3$  from  $L_0$  as  $L_i = H(L_0, NI_i)$ , where  $H$  is a one-way cryptographic hash function and  $NI_i$  is the  $i$ th provider's national identifier. With this scheme, patients can access all of their records with  $L_0$ , while  $P_i$  need only maintain a single key,  $L_i$ , for each patient. The Fusion Store itself has access to none of these keys and thus no visibility into either the metadata tree or the stored data records.

**Storing data.** Providers add new records to the Fusion Store by encrypting them with their corresponding keys. In Figure 3, for example, when  $P_2$  wants to store a data record linked to  $N_8$ , it opens the lockboxes recursively from  $N_2$  to  $N_8$ , reads the encryption key  $K_8$ , and encrypts the data record with  $K_8$ .

**Delegating access.** Providers delegate access to records in a subtree by sharing the key contained in the lockbox of the subtree's root. The delegatee can then recursively obtain access to the metadata and data records in the subtree.

**Revoking access.** In Figure 3, suppose provider  $P_2$  wishes to revoke delegated access to, say, provider  $P_3$  after the patient completes a course of treatment. Because both providers have valid access to existing records, the Fusion

## COVER FEATURE

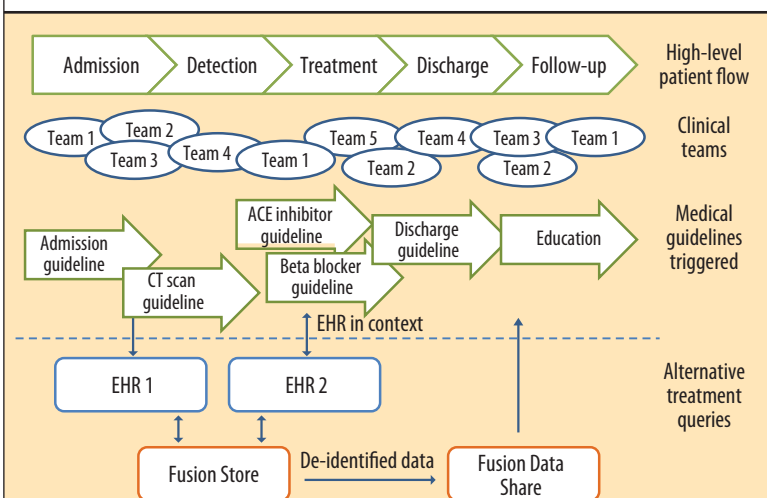

**Figure 4.** Healthcare applications interact via the Fusion Store and Fusion Data Share systems.

Store does not terminate access to those records, but only to records created after the relationship ends.

The challenge is to generate new versions of encryption keys such that old records can still be decrypted using the new keys while newly encrypted records are unreadable using the old keys. The Fusion Store solves this problem by *rotating* the old keys in a cryptographically secure manner to obtain new keys; to prevent reuse of old keys, it relies on *lazy revocation*, wherein rotation of a key terminates access to new records by providers using the old keys.<sup>6</sup>

In Figure 3, for example, suppose provider  $P_2$  revokes delegated access by provider  $P_3$  and rotates the old version of key  $K_6$  to  $K'_6$  at node  $N_6$ . It inserts node  $N_{10}$  after key rotation and encrypts its lockbox with  $K'_6$ . If  $P_2$  now shares  $K'_6$  with  $P_1$ , provider  $P_1$  can decrypt the lockbox at  $N_{10}$ , rotate  $K'_6$  back to  $K_6$ , and use  $K_6$  to obtain access to old records. However,  $P_3$  cannot rotate  $K_6$  forward to obtain  $K'_6$  and thus cannot access node  $N_{10}$ .

Asymmetric encryption keys make it possible to securely separate permissions necessary to read records from those necessary to create records.

### Fusion Store benefits

The Fusion Store primarily deals with the secure storage and sharing of data, and toward that end provides the following benefits in the context of a cloud-based EHR. Additional components such as auditing and consent/notification that are necessary for meeting regulatory compliance are subjects of future research.

**Secure navigation of patient health data.** A consulting healthcare provider can browse a patient's history represented in the metadata tree and ask for permission to access certain data records from other providers without being able to see the rest of the data records.

**Security and privacy within the cloud.** Since all data residing in the cloud is encrypted, and the Fusion Store by itself cannot decrypt the data, the security and privacy of data at rest are guaranteed.

**Simple management of encryption keys.** The patient maintains a single secret, and each provider maintains a single key for each patient. All other necessary keys are either derived from these secrets or recovered from lockboxes at the metadata tree's nodes. This reduces the overhead of secure key management for patients and providers.

**Seamless sharing of healthcare data.** A patient can access all treatment data once providers release it into the cloud. Similarly, providers can share data without involving the patient and ensure that only relevant data is shared.

**Simple access revocation.** Using key rotation and lazy revocation, the Fusion Store balances the continuing need for retroactive access to records, while terminating access to new records that should no longer be visible to unauthorized providers.

## DATA MODELING AND INTEGRATION

A fundamental tenet of Fusion is that it provides an open environment for applications to store and share healthcare-related information. Healthcare applications typically have their own data types and formats, but also need to share information with other applications. Because the Fusion Store neither imposes nor provides any structure for the data records it stores, data integration in Fusion must address disparate data sources and sinks.

As an example of these diverse, integrated applications, consider Figure 4, which shows the path of a patient who interacts with multiple healthcare providers including clinical teams of doctors, diagnostic test centers, and a pharmacy. In these interactions, the patient is the only entity that is constantly involved in all steps. The figure shows the patient's EHRs from the different teams being submitted to the Fusion Store. This information can then provide context to subsequent teams for decision making—for example, for selecting high-level clinical pathways, guidelines, and progress of care or for reducing the communication needed to coordinate care.

Application developers and integrators use Fusion's data-modeling tools to define data formats that they produce and consume. Fusion's data-modeling approach is object-oriented and uses common tools, techniques, and terminologies found in other data-modeling environments such as the Unified Modeling Language.



Fusion's data modeling process has a threefold role. First, it provides a core model for sharing information among multiple healthcare applications. Fusion's data model defines concepts common to various EHR applications and is built upon existing relational models used in EHR systems and controlled vocabularies such as SNOMED CT ([www.ihtsdo.org/snomed-ct](http://www.ihtsdo.org/snomed-ct)), ICD-9-CM ([www.cdc.gov/nchs/icd/icd9cm.htm](http://www.cdc.gov/nchs/icd/icd9cm.htm)), and LOINC (<http://loinc.org>). Fusion's modeling tools support vocabulary transformations like those defined in the Unified Medical Language System (UMLS) Metathesaurus ([www.nlm.nih.gov/research/umls/knowledge\\_sources/metathesaurus/index.html](http://www.nlm.nih.gov/research/umls/knowledge_sources/metathesaurus/index.html)). The core model also captures common concepts supporting third-party applications such as billing, provisioning, and asset management.

Second, while Fusion's core concepts allow interoperability, the object-oriented data modeling process enables extensions for specific EHR applications. Developers can easily build upon existing models in Fusion or introduce entirely new ones.

Third, Fusion's data models provide a means of discovering how applications represent data, helping developers to logically present information residing within the system. The open models support a naturally evolving environment for new services.

With Fusion's data modeling approach, creating or integrating services is typically a two-step process. First, the developer determines which parts of the existing, predefined data models it will work with and what extensions or new concepts to introduce. Fusion accordingly makes all new models available to other participants in the healthcare system. The service then uses the APIs defined within Fusion to retrieve the required EHR data.

## DATA SHARING

To build a knowledge base from each patient's encounter with healthcare providers and thereby increase efficiency, improve treatment outcomes, and reduce costs, Fusion makes de-identified data from the Fusion Store available to applications via the Data Share.

The Data Share relies on Fusion's common data policy management mechanisms (see Figure 2) to manage data access and sharing. In particular, it relies on the de-identification service for moving data from the Fusion Store to the Data Share and the authorization and authentication services for access control. Fusion can provide explicit means for obtaining patients' consent for secondary use of their records when they register with a provider, simplifying the consent/notification process. Unlike data in the Fusion Store, the Data Share's de-identified data is more broadly sharable, and thus has less stringent security requirements. Data mining and analysis applications can directly retrieve and process the data either offline or using compute and storage facilities offered by cloud providers.

Figure 4 illustrates use of the Data Share in support of an evidence-based healthcare application.<sup>7</sup> Such an application combines information about a patient under study with de-identified data from other patients with a similar demographic and health history to assess and prioritize various medical options. While patients have an incentive to share their data to improve their own treatment outcome, data sharing across a large population of patients will also benefit providers, medical researchers, pharmaceutical companies, public health agencies, and commercial or government payers by helping them to address systemwide concerns including effectiveness, safety, efficiency, productivity, patient satisfaction, and health service coordination and integration.



**Data sharing across a large population of patients will also benefit providers, medical researchers, pharmaceutical companies, public health agencies, and commercial or government payers.**

## RELATED WORK

The current EHR market is relatively fragmented, with no single dominant player.<sup>8,9</sup> About half a dozen commercial systems provide functionality that they have developed and refined over many years. These systems have typically focused on the data sharing and interoperability needs of hospitals or large outpatient clinics, although increasingly they are serving smaller clinics as well. In addition, several open source EHR products are available as well as a growing number of cloud-delivered offerings from emerging vendors.

In the US, the development of regional and nationwide health information exchanges<sup>10</sup> with common standards, services, and policies has been a goal for decades, with significant research funding by the Department of Health and Human Services. For example, HHS has supported creation of the UMLS and various regional health information organizations and networks. The HITECH Act offers major financial incentives for providers to enable sharing of EHR information but, except for vertically integrated providers or in some cases providers with the same EHR vendor, there is still little interoperability among systems used by clinics and hospitals, with most independent providers continuing to share patient records through printed or faxed documents.

There have been a few cloud-based, consumer-controlled personal health record (PHR) systems on the market, including Microsoft HealthVault ([www.microsoft.com/en-us/healthvault](http://www.microsoft.com/en-us/healthvault)) and Google Health (discontinued in 2011), but they have had limited success and adoption. In addition, many commercial EHR vendors now offer

## COVER FEATURE

so-called tethered PHRs that are essentially patient-facing views of their internal EHRs. Patients using these systems can view information released by their doctors and in some instances supplement it with information they enter themselves. However, tethered PHR systems usually do not allow the integration of data originating from multiple vendors or even institutions, nor do they let patients manage the sharing of information among other stakeholders. All PHR service providers have visibility into all patient data, and thus cannot guarantee the degree of control over security and privacy that Fusion offers.

Practice Fusion ([www.practicefusion.com](http://www.practicefusion.com)) and CareCloud ([www.carecloud.com](http://www.carecloud.com)) are EHR products that use a cloud model, but the cloud encrypts data and manages keys, enabling the service provider to see all the EHR data hosted in its environment.

PatientsLikeMe ([www.patientslikeme.com](http://www.patientslikeme.com)) lets users join a social network of patients with the same disease or disorder. They disclose the details of their condition voluntarily to the network, encourage each other during care, and share their own perspective when another patient in that group needs to make a decision such as which treatment option to choose.

**F**usion is an experimental open, cloud-based platform for large-scale, low-cost delivery of both existing and newly developed healthcare applications. It enables broader use of patient-centric management of electronic health records and facilitates the secure and seamless sharing of EHRs among stakeholders in a healthcare system, protecting patient privacy while improving system efficiency, treatment outcomes, and quality of care.

Although Fusion's design is agnostic to the choice of the underlying cloud infrastructure, we are building a research prototype on HP Cloud Services to demonstrate its feasibility. Thus far, we have prototyped major architectural components to validate the data access protocols, including encryption key generation from the metadata tree structure, key rotation, and key revocation. Preliminary studies indicate that Fusion can meet expected performance and cost targets.

We have started integrating several existing open source EHR applications—notably Oscar ([www.oscarcanada.org](http://www.oscarcanada.org)), OpenMRS (<http://openmrs.org>), and OpenEMR ([www.open-emr.org](http://www.open-emr.org)). Because these applications have existing data models in the form of relational database schemas, we have incorporated concepts within these applications into data models to explore the modeling tools necessary for Fusion. We have also developed bridges between the relational stores and the Fusion Store to transfer medical records between them. 

## References

- Centers for Medicare and Medicaid Services, "National Health Expenditure Data," 11 Apr. 2012; [www.cms.gov/NationalHealthExpendData](http://www.cms.gov/NationalHealthExpendData).
- Office of the Nat'l Coordinator for Health Information Technology, "HITECH Programs," 27 Jan. 2011, US Dept. Health and Human Services; [http://healthit.hhs.gov/portal/server.pt/community/healthit\\_hhs\\_gov\\_hitech\\_programs/1487](http://healthit.hhs.gov/portal/server.pt/community/healthit_hhs_gov_hitech_programs/1487).
- "Directive 95/46/EC of the European Parliament and of the Council of 24 October 1995 on the Protection of Individuals with Regard to the Processing of Personal Data and on the Free Movement of Such Data," *Official J. European Communities*, no. L 281, 23 Nov. 1995, pp. 31-39; [http://ec.europa.eu/justice/policies/privacy/docs/95-46-ce/dir1995-46\\_part1\\_en.pdf](http://ec.europa.eu/justice/policies/privacy/docs/95-46-ce/dir1995-46_part1_en.pdf).
- J. Li and A.H. Karp, *Zebra Copy: A Reference Implementation of Federated Access Management*, tech. report HPL-2007-105, Hewlett-Packard Development Co., 2007; [www.hpl.hp.com/techreports/2007/HPL-2007-105.html](http://www.hpl.hp.com/techreports/2007/HPL-2007-105.html).
- M. Rosenblum and J.K. Ousterhout, "The Design and Implementation of a Log-Structured File System," *ACM Trans. Computer Systems*, Feb. 1992, pp. 26-52.
- M. Kallahalla et al., "Plutus: Scalable Secure File Sharing on Untrusted Storage," *Proc. 2nd Usenix Conf. File and Storage Technologies (FAST 03)*, Usenix, 2003, pp. 29-42.
- T.E. Love et al., "Electronic Medical Record-Assisted Design of a Cluster-Randomized Trial to Improve Diabetes Care and Outcomes," *J. General Internal Medicine*, Apr. 2008, pp. 383-391.
- C.-J. Hsiao et al., "Electronic Medical Record/Electronic Health Record Use by Office-Based Physicians: United States, 2008 and Preliminary 2009," Centers for Disease Control and Prevention, Dec. 2009; [www.cdc.gov/nchs/data/hestat/emr\\_ehr/emr\\_ehr.htm](http://www.cdc.gov/nchs/data/hestat/emr_ehr/emr_ehr.htm).
- T.J. Handler, *Magic Quadrant for Global Enterprise EHR Systems*, industry research report G00214841, 6 Sept. 2011, Gartner.
- Office of the Nat'l Coordinator for Health Information Technology, "Nationwide Health Information Network Exchange," 16 May 2012, US Dept. Health and Human Services; [http://healthit.hhs.gov/portal/server.pt/community/healthit\\_hhs\\_gov\\_nhin\\_exchange/1407](http://healthit.hhs.gov/portal/server.pt/community/healthit_hhs_gov_nhin_exchange/1407).

*Sujoy Basu is a senior scientist at HP Labs, where he has worked on Web services, distributed computing, networking, multimedia content distribution networks, and processor and system architecture. Basu received a PhD in computer science from the University of Illinois at Urbana-Champaign. He is a senior member of IEEE and ACM. Contact him at [sujoy.basu@hp.com](mailto:sujoy.basu@hp.com).*

*Alan H. Karp is a principal scientist in the Intelligent Infrastructure Laboratory at HP Labs, where he is conducting research on the resilience of distributed applications at scale. He also heads the Virus Safe Computing Group, which implements usable security. Karp received a PhD in astronomy from the University of Maryland. He is a member of the IEEE Computer Society, ACM, the American Astronomical Society, and the International Astronomical Union. Contact him at [alan.karp@hp.com](mailto:alan.karp@hp.com).*

**Jun Li** is a principal scientist at HP Labs. His research focuses on large-scale policy-aware data management frameworks to ensure correct management of business-critical data in the cloud computing environment. Li received a PhD in computer engineering from Carnegie Mellon University. Contact him at [jun.li@hp.com](mailto:jun.li@hp.com).

**James Pruyne** is a senior scientist at HP Labs, where his work focuses on developing methods for monitoring and managing distributed environments, starting with client-server systems and evolving to service-oriented approaches. Pruyne received a PhD in computer sciences from the University of Wisconsin-Madison. Contact him at [james.pruyne@hp.com](mailto:james.pruyne@hp.com).

**Jerry Rolia** is a principal scientist in the Services and Solutions Research Lab at HP Labs. His research interests include cloud computing, healthcare information systems, capacity management, and performance engineering. Rolia received a PhD in computer science from the University of Toronto. Contact him at [jerry.rolia@hp.com](mailto:jerry.rolia@hp.com).

**Sharad Singhal** is a distinguished scientist at HP Labs. His research interests include speech and video processing, neural networks, middleware, and personal communications services. Singhal received a PhD in engineering and applied science from Yale University. He is a member of

IEEE and the Acoustical Society of America. Contact him at [sharad.singhal@hp.com](mailto:sharad.singhal@hp.com).

**Jaap Suermondt** is the director of healthcare research at HP Labs. His research spans analytics, electronic health records, personalization, data mining, storage and information management, decision support systems, patient safety, and operational efficiency. Suermondt received a PhD in medical information sciences from Stanford University School of Medicine. He is a Fellow of the American College of Medical Informatics. Contact him at [jaap.suermondt@hp.com](mailto:jaap.suermondt@hp.com).

**Ram Swaminathan** is a senior scientist at HP Labs. His research interests include mathematics, especially linear algebra; combinatorial optimization; cryptography; and complexity theory. He has also actively worked on networking and storage systems. Swaminathan received a PhD in computer science from Purdue University. He is a member of the Mathematical Society of America, the American Mathematical Society, and the Society for Industrial and Applied Mathematics. Contact him at [ram.swaminathan@hp.com](mailto:ram.swaminathan@hp.com).

**cn** Selected CS articles and columns are available for free at <http://ComputingNow.computer.org>.



IEEE  computer society

## Corporate Affiliate Program

Increases technical training while cutting costs.

Provides company-wide, employee access to 4,300 technical courses, 600 technical and business books, dozens of Brainbench Exams and free or discounted training webinars and software development certifications.

For more information, call 1-855-727-3632 or email us at [cap@computer.org](mailto:cap@computer.org)

## COVER FEATURE



# Testing the Nation's Health-care Information Infrastructure: NIST Perspective

Kevin Brady, Ram D. Sriram, Bettijoyce Lide, and Kathleen Roberts

National Institute of Standards and Technology

**The National Institute of Standards and Technology is enabling the development of an integrated healthcare information infrastructure by developing test tools and techniques that will facilitate seamless exchange of information across the health-care enterprise.**

**A**ccording to the Centers for Medicare and Medicaid Services, the US spent nearly \$2.6 trillion on healthcare in 2010, an amount estimated to nearly double by the end of this decade ([www.cms.gov](http://www.cms.gov)). This rate of spending was underscored by Athenahealth CEO Jonathan Bush: "The US spends an amount equal to 300 percent of India's GNP on health-care, and India's population is three times ours" (*Fortune*, 16 Jan. 2012, p. 22). In an attempt to rein in healthcare costs, the Obama administration, like the preceding Bush administration, has initiated a major effort to move from paper-based medical record keeping to electronic health records (EHRs). These efforts established the Office of the National Coordinator for Health Information Technology (ONC) and formulated financial incentives for the nation's physicians to use EHRs, which will jointly lead to considerable automation in the healthcare industry.

To take advantage of such automation, information generated in the healthcare enterprise must be digitally encoded with the right semantics, archived for efficient storage and retrieval, and transported reliably, securely,

and efficiently, without any information loss. Accordingly, the National Institute of Standards and Technology has been working closely with ONC; Integrating the Healthcare Enterprise (IHE; [www.ihe.net](http://www.ihe.net)), an initiative by healthcare professionals and industry to improve the way healthcare computer systems share information; and other organizations, such as IEEE, to accelerate the adoption of information technology by US healthcare enterprises.

NIST, specifically its Information Technology Laboratory, is involved in several healthcare automation activities focused on developing associated test methods, protocols, and specifications, for interoperability. These projects, which frequently involve coordination with related organizations such as IHE, have been devised according to healthcare information flows.

## INFORMATION FLOW IN HEALTHCARE SERVICES

The healthcare services industry generates and processes large amounts of complex information relating to patient diagnosis, testing, monitoring, treatment, and health management; billing for healthcare services; and asset management of healthcare resources. Healthcare delivery is a collaborative process, with many physicians, specialists, nursing staff, and technicians from multiple organizations participating in patient treatment. In addition, many external organizations, including government agencies, insurance companies, employers, medical researchers, pharmacists, and even lawyers in malpractice suits use the resulting healthcare information.

The healthcare industry creates and uses different classes of information, including the following five types:<sup>1,2</sup>

- detailed medical records of each patient for every episode of illness or type of healthcare delivered;
- workflow for patient referrals to specialists,<sup>3</sup> physician orders for diagnostic tests or procedures, and hospital admission and discharge;
- detailed administrative records for managing healthcare resources—for example, scheduling patient appointments, tracking hospital bed utilization, and inventory management of pharmaceutical supplies;
- billing for healthcare services, healthcare cost control procedures, and coordination of benefits; and
- research reports, clinical observations, results of new pharmaceutical clinical trials, and new guidelines.

One category of information flow occurs within the healthcare services industry and is characterized as follows:

- An administrator obtains patient medical history, employment and social data, and health insurance information and enters the data into the patient's chart.
- A nurse records the patient's vital signs, medications, and chief complaints for a particular visit.
- A physician conducts an examination and writes or dictates an "encounter note" for subsequent transcription and signoff for inclusion in the chart. An administrator submits billing information identifying services rendered and the diagnosis codes for use in insurance claims.
- Larger healthcare institutions might have internal advisory groups that recommend treatment guidelines (evidence-based medicine) to be followed by the healthcare staff to improve healthcare quality.

A second category of information flow involves information exchanged between healthcare facilities:

- The physician might prescribe an order for a laboratory or diagnostic imaging test or procedure, refer the patient to a specialist, or have the patient admitted to a hospital. In some cases, the physician would include the patient's relevant clinical history.
- The results of a laboratory test or the report and images of a diagnostic imaging would subsequently be sent to the physician.
- Upon the patient's discharge from the hospital, the discharge summary would be sent to the patient's physician.

In the third category of information flow, information is transmitted between a healthcare facility and external agencies:

- The office administrator submits claims to an insurance agency using the physician-supplied codes for claims processing, and sometimes seeks benefits authorization for specialized treatment for the patient.
- Health insurance agencies might seek additional justification for treatment provided to the patient or for a recommended course of tests or treatment.
- Health insurance agencies might provide a list of preferred medications (formularies) and other cost containment measures to healthcare facilities.
- Managed care organizations and other payer agencies might also provide treatment guidelines.
- Life insurance companies might seek a patient's medical record to evaluate the risk of a policy applicant or to identify fraud due to a known, but undisclosed, preexisting medical condition.



**The foundation for healthcare information sharing is the electronic health record (or electronic medical record), as it contains all the relevant patient healthcare data in sharable form.**

- Clinic nursing staff occasionally might need to report incidents of certain diseases to public health agencies and record pediatric immunizations with the appropriate state's vital statistics bureau.
- Medical researchers might seek medical records of patients with certain profiles for investigations; the clinic might provide the information (with patient consent) after removing patient-identifiable data.
- Malpractice lawsuits might require a healthcare facility to submit medical records of patients (with profiles similar to the litigant's) to determine adherence to standards of practice.

Finally, accrediting organizations in this information flow category might review patient records to review operational and quality standards.

## ELECTRONIC HEALTH RECORDS

The EHR or electronic medical record (EMR) is the foundation for healthcare information sharing, as both contain all the relevant patient healthcare data in sharable form. In healthcare delivery, the EHR serves integrating functions similar to a manufacturing bill of materials. Although the terms EMR and EHR are used interchangeably, ONC makes a distinction between these two, as follows (see <http://www.healthit.gov>). EMRs represent digital versions of the paper charts in a doctor's office. An EMR contains the medical and treatment history of the patients in one practice, but the information in EMRs doesn't travel easily out

**COVER FEATURE**

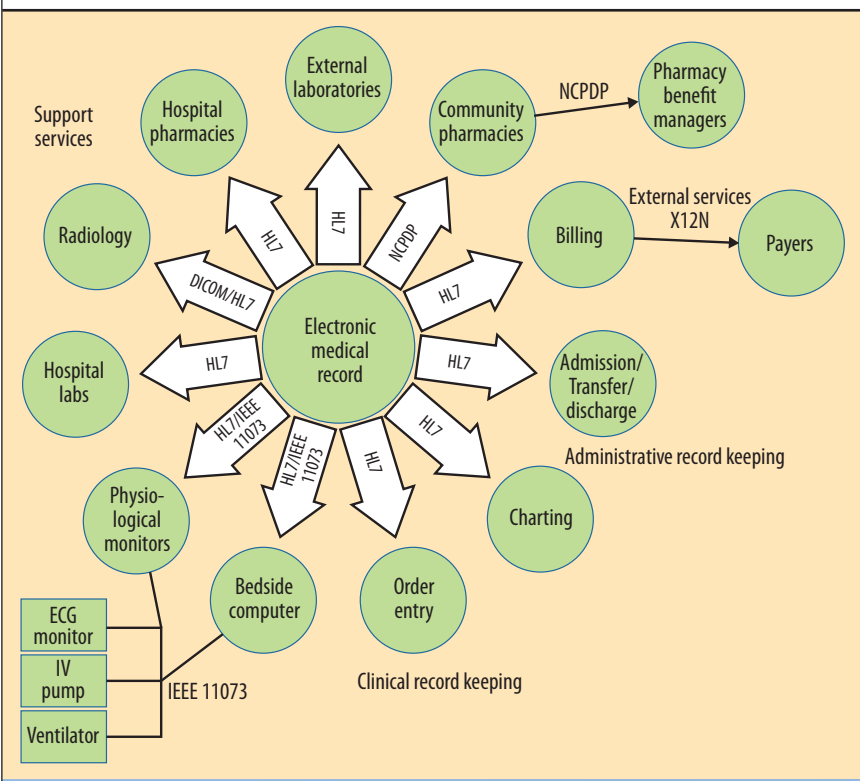

**Figure 1. Standards that link to an electronic health record.** (Source: US Congress, Office of Technology Assessment, *Bringing Healthcare Online: The Role of Information Technologies*, OTA-ITC-624, US Government Printing Office, Washington, D.C., 1995.)

hl7book.net/index.php?title=CDA) are exemplary in this regard.

HL7, briefly, is the global authority on interoperability standards for health IT ([www.hl7.org](http://www.hl7.org)).<sup>5</sup> Such measures would prevent the loss of information during data interchange that could otherwise occur due to differences in terms, codes, and related semantics in various healthcare vocabularies. By using IT that adheres to HL7, healthcare institutions could deal transparently with information obtained from external agencies as well as with information generated by in-house healthcare information systems. Their applications could perform data mining of patient medical records for healthcare quality metrics, identify patients across populations for timely medical interventions, and check for compliance with preventive-service protocols.

A variety of messaging and information exchange standards permits an enterprise to integrate the various health information systems and archive the data as an EHR or EMR ([www.nist.gov/healthcare/index.cfm](http://www.nist.gov/healthcare/index.cfm)).

of the practice. EHRs do all those things, and more. EHRs focus on the patient's total health, going beyond standard clinical data collected in the provider's office and include a broader view on a patient's care. EHRs are designed to reach out beyond the health organization that originally collects and compiles the information.

Although large healthcare institutions have significant investments in EHR-based computer systems, it is estimated that only a small percentage of US small practices use an EHR system in their daily practice ([www.aafp.org](http://www.aafp.org)).<sup>4</sup> In most healthcare settings—especially small clinics—paper-based records and fax-based communications are still the norm. Recent incentive programs issued by the Centers for Medicare and Medicaid Services, however, are accelerating EHR adoption by both small and large practices ([www.cms.gov/ehrincentiveprograms](http://www.cms.gov/ehrincentiveprograms)).

The adoption of standards for information interchange will help to integrate disparate healthcare systems. However, rather than being geared simply to support human readability of medical reports, healthcare data integration implementations should incorporate the formalism and details necessary for proper computer interpretability of such information. The formalism and details contained within NIST's Health Level Seven International's (HL7's) Clinical Document Architecture (CDA) standard ([In addition to HL7, such standards include Digital Imaging and Communications in Medicine \(DICOM\), IEEE 11073 Healthcare Devices and Personal Health Devices, and others listed by the Healthcare Information and Management Systems Society's Integrating the Healthcare Enterprise initiative and ANSI's Healthcare Information Technology Standards Panel.](http://</a></p>
</div>
<div data-bbox=)

Figure 1 illustrates the classes of clinical information and some of the standards that link these classes to a full EHR. Specifically, HL7 messaging standards allow disparate healthcare information systems to communicate with each other. Version 2.x, although the most common implementation, is likely to be superseded by version 3.0, which uses an object-oriented approach. Independent healthcare institutions can submit orders and referrals via HL7 for healthcare services for their patients. DICOM standards enable the interchange of information between imaging systems and facilitate remote access for physicians at their clinic.

With standards-based integration of information systems and authenticated remote access to reports and images, physicians can review radiologists' reports and diagnostic images for use in patient counseling. One concern with the current standards, however, is that they deal only with syntactic issues. Thus, due to the disparate

nature of the medical terminology in various EHRs (it is common for different EHRs to use different terminology to represent the same concept), it is increasingly important to develop tools and techniques for semantic interoperability.

## HEALTH IT TESTING AT NIST

NIST's Information Technology Laboratory (for brevity, we use "NIST" to denote this laboratory from here on) is collaborating with industry, healthcare informatics-related standards organizations, consortia, and government agencies to build tools and prototypes to advance the adoption of IT within healthcare systems. NIST researchers are carrying on several activities in particular:

- Collaborating with HL7 to help ensure that HL7 messaging and EHR systems' conformance can be defined and measured at an appropriate level.
- Providing technical leadership on IHE projects, specifically for cross-enterprise document sharing and patient care devices.
- Providing technical leadership to build a common Web-based tool set that integrates testing tools and activities of various standards development organizations, consortia, and other organizations; also, providing technical leadership on the development, selection, and implementation of security specifications for securely communicating health information.
- Collaborating with ONC to achieve a Nationwide Health Information Network (NwHIN) and developing several test procedures for "meaningful use." According to ONC, "meaningful use is the set of standards defined by the Centers for Medicare and Medicaid Services (CMS) Incentive Programs that governs the use of electronic health records and allows eligible providers and hospitals to earn incentive payments by meeting specific criteria."
- Collaborating with the Centers for Medicare and Medicaid Services to provide guidance on the Health Insurance Portability and Accountability Act Security Rule.
- Participating in the ONC Federal Advisory Committee on Health Information Technology Standards Com-

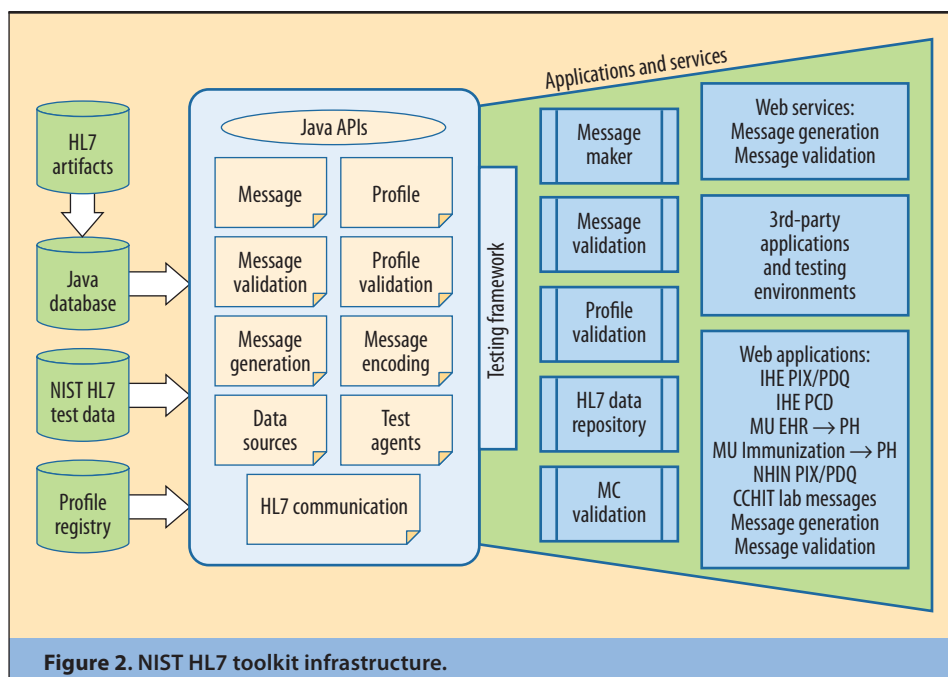

Figure 2. NIST HL7 toolkit infrastructure.

mittee and associated working groups to pursue these efforts. Working groups include HL7, IEEE 11073, the National Council for Prescription Drug Programs, and the American Telemedicine Association.

Following are several NIST projects, at various stages of completion, that have resulted from these activities.

### HL7 testing toolkit

As Figure 2 shows, NIST is building a toolkit for testing HL7 message interfaces based on message profiles. The toolkit's foundation is a set of Java APIs and a testing framework that supports activities such as automated message generation, message validation, and use case testing. Developers can use the toolkit to build tools or Web services, or they can incorporate it into third-party applications and testing environments.

NIST has applied the toolkit to develop numerous tools for creating messages, cross-referencing patient identity, and formulating EHR queries. The toolkit's main focus is on HL7 version 2, although developers have recently added capabilities to the toolkit to support version 3 validation. Tools are delivered as stand-alone applications, Web services, and Web applications.

The HL7 (version 2) standard, around which we have based the toolkit, is a specification for moving clinical and administrative information between healthcare applications. In the US, 90 percent of hospitals use the HL7 standard. Its adoption in other care settings such as outpatient and long-term care facilities or telemedicine is necessary to ensure that organizations can reap the benefits of widespread electronic communication. However,

## COVER FEATURE

the cost-restrictive nature of managing an HL7 system to achieve interoperability is a concern for widespread adoption in these other settings.

When originally developed, the HL7 standard was designed to accommodate the many diverse processes within the healthcare industry. Although a universal design was necessary to gain broad industry support, the initial design resulted in a standard that could not be sufficiently constrained to provide a single and consistent interpretation, which prohibited plug-and-play installations. Consequently, systems were difficult to implement and debug, resulting in undue costs.

To help alleviate this shortcoming, HL7 introduced the concept of message profiles. A message profile is a subset of the HL7 messaging standard that constricts message definition so that it specifically states a message's optional constructs and processing rules. However, if EHR vendors do not follow the profile rules, interoperability problems will persist. Conformance testing is essential. NIST is developing testing tools to ensure that vendors apply message profiles as intended to fulfill the promise of interoperable healthcare systems.



**Legislation calls for the voluntary certification of health information technology to encourage more widespread adoption of interoperable health IT.**

### Clinical Document Architecture validation

The HL7 version 3 Clinical Document Architecture (CDA) is an XML-based markup standard intended to specify the encoding, structure, and semantics of clinical documents for exchange, and is not itself a document type. CDA was developed using the HL7 development framework, which is based on the HL7 Reference Information Model. NIST—in collaboration with IHE's Patient Care Coordination (PCC) domain, the Quality, Research and Public Health domain, and HL7—is working on a series of testing tools for promoting CDA's adoption by vendors and users of healthcare information systems.

The toolkit can validate documents from legacy Health Information Technology Standards Panel ([www.hitsp.org](http://www.hitsp.org)) work, the IHE PCC domain documents, and HL7 documents. The toolkit also includes sample documents of syntactically correct XML files for most document types. The NwHIN testing team also uses this toolkit at IHE Connectathons (multivendor testing events held worldwide) to check for meaningful use (MU) and for patient identity to validate documents being exchanged. Users access the tool via a webpage form where they upload their XML file or through a SOAP-based Web service to automatically

load and validate from external applications. NIST has future plans to expand the toolkit to support the Quality Reporting Document Architecture's Quality Reporting and e-Measures format.

### Meaningful-use Stage 1 test method

The US Health Information Technology for Economic and Clinical Health (HITECH) Act, enacted as part of the 2009 American Recovery and Reinvestment Act, emphasizes the need for the US to begin using EHRs. To encourage more widespread adoption of interoperable health IT, the legislation calls for ONC, in consultation with NIST, to establish a program for the voluntary certification of health IT as being in compliance with applicable criteria to meet defined MU requirements. MU will be implemented in three stages: Stage 1 in 2011, Stage 2 in 2013, and Stage 3 in 2015. Further details of these stages can be obtained at [www.healthit.gov](http://www.healthit.gov). Physicians will receive federal financial incentives depending on how well they conform to criteria described in rules associated with each stage.

Under the health IT certification program, ONC-authorized testing organizations use the NIST test method and conformance tools to evaluate EHR software and systems so that doctors' offices, hospitals, and other healthcare providers can have confidence in the systems they purchase. In collaboration with ONC, NIST has developed the necessary functional and conformance testing requirements, test cases, and test tools in support of Stage 1 of the MU health IT certification program and is currently working on the other two stages.

In August 2010, NIST published an ONC-approved test method (encompassing test procedures, data, and tools) for testing EHR systems to meet MU Stage 1 certification criteria and standards. During the test method's development, NIST collaborated with ONC to ensure that the relevant standards and certification criteria were consistent and effectively represented within the test procedures. The approved NIST-developed test method evaluates EHR system components such as electronic prescribing of patient prescriptions to pharmacies, submission of laboratory results to the Centers for Disease Control and Prevention (CDC), how pediatric doctors plot and display growth charts of patients, and how vendors control access so that only authorized users can retrieve information.

The following tools for MU Stage 1 testing are complete and available from NIST (we are working on Stage 2 tools, which should be available in a few months):

- Stage 1 Test Method ([http://healthcare.nist.gov/use\\_testing/effective\\_requirements.html](http://healthcare.nist.gov/use_testing/effective_requirements.html)). This method defines the approved version 1.1 test procedures that Authorized Testing and Certification Bodies (ATCBs) use in the health IT certification program.



- Reportable Lab Results and Immunizations (<http://healthcare.nist.gov:8080/HL7V2MuValidation2011>). With this HL7 v2 test tool, ATCBs can assess the certification criteria for doctors to use in submitting immunizations and reporting lab results to the CDC.
- Clinical Document Architecture (CDA) Validation (<http://hit-testing.nist.gov/cda-validation/mu.html>). NIST provides an HL7 Continuity of Care Document (CCD) validation tool designed specifically to support MU Stage 1 testing.

According to ONC, more than 2,500 EHR products for ambulatory care and more than 800 products for in-patient care are currently certified for MU Stage 1 (<http://oncchpl.force.com/ehrcert/CHPLHome>; a product is not necessarily a complete EHR—see ONC's website for definition of a product). All products can be traced back to NIST-developed test procedures and tools.

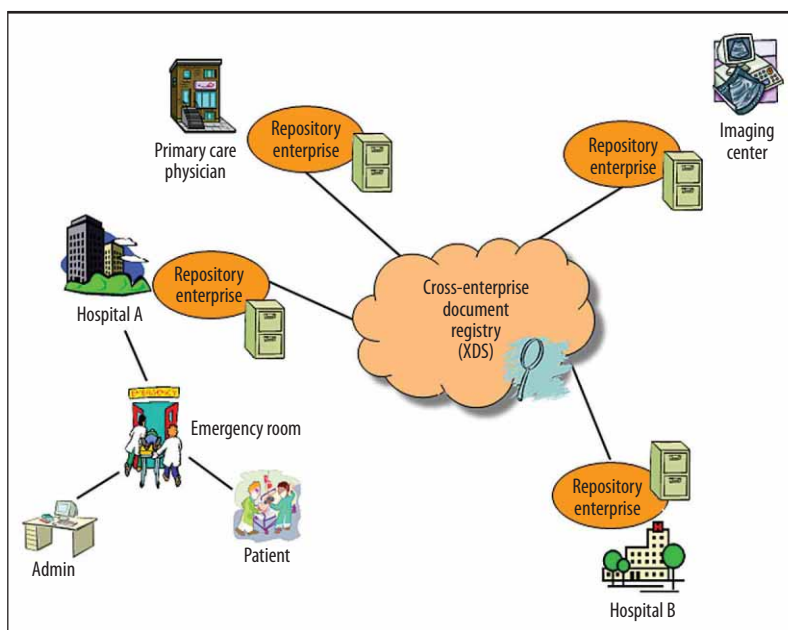

**Figure 3. Cross-enterprise document sharing (XDS).** Healthcare professionals within a community can use XDS to access a patient's clinical information regardless of where it is located.

### Cross-enterprise document sharing

NIST is working with industry to develop a standards-based registry infrastructure that will allow healthcare professionals to find and access all pertinent patient clinical information regardless of the healthcare organization that creates and manages the documents. Additionally, NIST is collaborating on the IHE project on Cross-Enterprise Document Sharing (XDS). Specifically, NIST is a primary author of the XDS standards-based specification. As Figure 3 shows, healthcare professionals can use XDS to manage document sharing between any healthcare enterprise, from a private physician's office to an acute care in-patient facility and personal health record systems.

Sharing is managed through document repositories and a document registry to create a longitudinal patient information record within a given clinical domain. These are distinct entities with separate responsibilities. A document repository stores documents in a transparent, secure, reliable, and persistent manner and can respond to document retrieval requests. A document registry stores information about those documents so that the documents of interest for a patient's care can be easily found, selected, and retrieved irrespective of the repository where they are actually stored.

Using document registries to share clinical information intraorganizationally presents unique challenges: data interoperability and interchange, for example, requires standardized metadata, interfaces, and formats; moreover, the technology must support strict adherence to security and privacy policies related to healthcare information.

NIST has developed a reference implementation for the XDS specification and a Web-based test suite, allowing vendors to determine conformance to the XDS profile. Vendors also use the test suite as an early stage tool for interoperability testing. The reference implementation is available as IHE open source, an open source project hosted on Source Forge (<http://iheos.sourceforge.net>). The NIST test suite is available at <http://ihexds.nist.gov>.

### Medical device communication testing

In a typical intensive care unit, a patient might be connected to one or more vital-sign monitors, receive fluids through multiple infusion pumps, and be supported by a ventilator. Each of these medical devices can capture volumes of data, which is available multiple times per second, on a per-patient basis. Today, these devices do not communicate and have little or no plug-and-play interoperability.

Medical device interoperability raises several issues:

- Manually captured data is labor intensive, recorded infrequently, and prone to human error.
- Expensive custom connectivity equipment might be used only for patients with acute needs.
- Detection of patient problems such as adverse drug events is hindered due to the inability to collect real-time data from multiple devices.
- Vendors intending to communicate data between devices must develop specialized interfaces for each device.

## COVER FEATURE

The ISO/IEEE 11073 (x73) Healthcare Devices and Personal Health Devices Working Groups are defining a set of standards to enable medical devices to interoperate and electronically capture and process data. These working groups are collaborating with the IHE Patient Care Device Domain to develop a framework for integrating medical device data into an EHR.

NIST is actively developing medical device communication test methodologies and tools to enable consistent and correct communication between medical devices and device-gateways across the healthcare enterprise. This work is intended to provide standards-based, rigorous validation of medical device communication through conformance leading to interoperability. Rigorous testing is essential to achieve multivendor and enterprise-wide interoperability, and it must be predicated on sufficiently specified medical device and enterprise-communication standards. The NIST software test tools aim to meet the X73-defined requirements as well as the enterprise/electronic health record level defined in the HL7 messaging standard.



**Electronic health information exchange that follows patients across providers regardless of geographical boundaries greatly improves the clinical decision-making process.**

A related tool is the ICSGenerator (<http://hit-testing.nist.gov/medicaldevices/index.html>), which facilitates creation of vendor conformance statements that would be applicable to testing a particular X73 device. With the ICSGenerator, users can easily develop and produce implementation conformance statements. Users such as medical device vendors, manufacturers, and clinical engineers can execute the tool to produce statements that disclose details of a specific implementation and specify the features provided by a particular medical device—that is, a device profile. Medical device vendors can compare device implementation conformance statements based on, and required by, the x73 standards and use them across device interfaces to help overcome the semantic interoperability problem.

Conformance test tools can use device profiles in conjunction with messages to and from devices to determine standards conformance and validity. The ValidatePDU tool can determine not only the correctness of the x73 message, but also the message's compliance to a user-defined profile (derived via the ICSGenerator tool). ValidatePDU provides basic syntax, structure, and low-level semantic checking for one or more captured messages. Both ValidatePDU and ICSGenerator use the electronic representation of the x73 standards information model that NIST researchers imple-

mented in an XML schema. These tools (and information model) are publicly available (<http://hit-testing.nist.gov/medicaldevices/index.html>). Medical device test message generation is also possible to facilitate future manager/agent conformance test scenarios.

## IHE CONNECTATHONS

Each year, the IHE sponsors Connectathons in North America, Europe, and Asia to promote interoperability among IHE profile implementations ([www.ihe.net/connectathon](http://www.ihe.net/connectathon)). The Connectathons are cross-vendor structured testing events where developers of health information systems can compare their implementations with those of other vendors. The goal is to promote the adoption of standards-based interoperability solutions defined by IHE in commercially available healthcare IT systems.

The 2012 North American Connectathon held in Chicago, Illinois, featured more than 160 systems from 117 participating organizations, which performed and verified more than 3,500 successful tests of IHE integration profiles. Ninety percent of the applications demonstrated at the Connectathon used the NIST test tools. Participants and monitors use NIST tooling in cross-enterprise document sharing, patient identity and queries, patient care devices, and CDA validation to compare them against the IHE profiles.

Interest in the Connectathons and NIST tooling to support them has been growing; at the 2012 event, IHE Korea and IHE Japan began using NIST tooling with IHE Australia to learn how to use the technology for their respective Connectathons.

## NWHIN TESTING

NWHIN is a set of standards, services, and policies that enable secure health information exchange over the Internet. NWHIN is not a physical network but rather is a foundation for the communication of health information across diverse entities and communities around the country. Electronic health information exchange that follows patients across providers regardless of geographical boundaries greatly improves the clinical-decision-making process by providing clinicians with updated, relevant, and accessible patient data (<http://nwhin.siframework.org/Nwhin+Basics>.)

These standards, services, and policies enhance patient care quality and evolve care coordination by helping move current paper-based medical records to an electronic process for securely storing and sharing EHRs. NIST has been involved in the testing process for “on-boarding,” the process by which an organization joins the Nationwide Health Information Network Exchange, which verifies that it complies with NWHIN-supported specifications. On-boarding includes verifying an organization's eligibility for participation (must be a federal agency or ONC contractor), that its

gateway complies with the NwHIN specifications, and that it can exchange information.

NwHIN uses an existing set of NIST tools with modifications based on the NwHIN specifications (<http://hit-testing.nist.gov:12080/xdstools2nwhin>). The tools include XDS, Cross-Community Patient Discovery Query and Retrieve (XCPD), Patient Identity Cross Reference, Patient Discovery Query, and a CDA validator. These tools help to automate the on-boarding process and allow potential participants to completely test their gateways at the NIST website before they start on-boarding. The NwHIN network might play a larger role in meaningful use testing in Stage 2.

**T**he creation of an integrated healthcare information infrastructure depends on all parties involved—consumers, healthcare professionals, researchers, and insurers—having systems, tools, and information that are complete, correct, secure, and interoperable. Until we achieve a full-scale interoperability of software systems in the healthcare enterprise, we will not realize the full benefits of using information technology in healthcare. Achieving true interoperability would require that three tightly integrated activities must succeed: standards development, implementation support (including implementation guidance and precertification testing), and comprehensive conformance and interoperability testing. Thus, true interoperability testing cannot be achieved without having the right standards, implemented in the right way, and tested—both for syntax and semantics—to the right requirements. NIST will continue the research and development activities required to support and test a fully integrated and interoperable healthcare enterprise. **■**

## Acknowledgments

Project leads for the various projects include Robert Snellick (HL7 V2 Testing Toolkit), Ken Gebhart (Meaningful Use), Bill Majurski (Cross-Enterprise Document Sharing), John Garguilo (Medical Device Interoperability), Andrew McCaffrey (CDA validation), and Gavin O'Brien (NwHIN). Lisa Carnahan initiated the testing projects during her term as the leader of the health IT conformance testing program; Mary Laamanen and Sandra Martinez also contributed efforts in CDA and Medical Devices, respectively. We appreciate the input from Steven J. Fenves and Lisa Carnahan on this article.

## References

1. C. Bock et al., *Healthcare Strategic Focus Area: Clinical Informatics*, NIST Internal Report 7263, Nat'l Inst. of Standards and Technology, Washington, D.C., 2005.
2. National Research Council, *For the Record: Protecting Electronic Health Information*, National Academies Press, 1997.
3. M. Ramaiah et al., "Workflow and Electronic Health Records in Small Medical Practices," *AHIMA's Online*

*Research J., Perspectives in Health Information Management*, 2012.

4. S.R. Rao et al., "Electronic Health Records in Small Physician Practices: Availability, Use, and Perceived Benefits," *J. Am. Medical Informatics Assoc.*, vol. 18, no. 3, 2011, pp. 271-275.
5. T. Benson, *Principles of Health Interoperability: HL7 and SNOMED*, Springer, 2010.

**Kevin Brady** is Interoperability Group leader, Systems and Software Division, Information Technology Laboratory, National Institute of Standards and Technology. His research interests include health information technology, smart healthcare, and cyberphysical systems. Brady received an MS in computer science from the George Washington University. Contact him at [kevin.brady@nist.gov](mailto:kevin.brady@nist.gov).

**Ram D. Sriram** is chief of the Systems and Software Division, Information Technology Laboratory, National Institute of Standards and Technology. His research interests include distributed design, artificial intelligence, and smart networked systems and societies. Sriram received a PhD in civil engineering from Carnegie Mellon University. He is a senior member of IEEE, a fellow of ASME and AAAS, and a life member of AAAI and ACM. Contact him at [ram.sriram@nist.gov](mailto:ram.sriram@nist.gov).

**Bettijoyce Lide** is the health IT program manager, Information Technology Laboratory, National Institute of Standards and Technology. Her research interests include health information technology, evaluated scientific data, and collaborations on cutting-edge R&D. Lide received an MS in chemistry, information technology, and management from the American University. She is a member of the American Chemical Society. Contact her at [bjlide@nist.gov](mailto:bjlide@nist.gov).

**Kathleen Roberts** is associate director for federal and industrial relations, Information Technology Laboratory, National Institute of Standards and Technology. Roberts received an MS in computer science from the George Washington University. Contact her at [Kathleen.Roberts@nist.gov](mailto:Kathleen.Roberts@nist.gov).

The identification of certain commercial software systems in this article does not imply recommendation or endorsement by NIST nor does it imply that the products identified are necessarily the best available for the purpose. Further, any opinions, findings, conclusions, or recommendations expressed in this material are those of the authors and do not necessarily reflect the views of NIST or any other supporting US government or corporate organizations.



Selected CS articles and columns are available for free at <http://ComputingNow.computer.org>.



## IEEE 9th World Congress on Services (SERVICES 2013)

June 28-July 3, 2013, Santa Clara Marriott, CA, USA (center of Silicon Valley)  
Federation of 5 Theme Topic Conferences on Services from Different Angles  
(<http://www.servicescongress.org>)



### IEEE 6th International Conference on Cloud Computing (CLOUD 2013)

Cloud Computing is becoming a scalable services delivery and consumption platform in the field of Services Computing. The technical foundations of Cloud Computing include Service-Oriented Architecture (SOA) and Virtualizations. Major topics cover Infrastructure Cloud, Software Cloud, Application Cloud, and Business Cloud. Visit <http://thecloudcomputing.org>.

### IEEE 20th International Conference on Web Services (ICWS 2013)

ICWS 2013 will feature data-centric, web-based services modeling, design, development, publishing, discovery, composition, testing, QoS assurance, adaptation, and delivery technologies and standards. Visit <http://icws.org>.



### IEEE 10th International Conference on Services Computing (SCC 2013)

SCC 2013 will focus on services innovation lifecycle e.g., enterprise modeling, business consulting, solution creation, services orchestration, optimization, management, business process integration and management. Visit <http://conferences.computer.org/>



### IEEE 2nd International Conference on Mobile Services (MS 2013)

MS 2013 will feature all aspects of mobile services including modeling, construction, deployment, middleware, and user experience with a special emphasis on context-awareness in social settings. Visit <http://themobileservices.org/2013>.



### IEEE 2nd International Conference on Services Economics (SE 2013)

SE 2013 will focus on quantitative analysis of impact on service financial and enterprise operational outcome from BigData initiative, including outcome metrics identification, risk assessment and trade-off of IT solution selection and optimization of IT expense. Visit <http://ieeese.org/2013>.



Sponsored by IEEE Technical Committee on Services Computing (TC-SVC, <http://tab.computer.org/tcsc>)

Conference proceedings are EI indexed. Extended versions of invited ICWS/SCC/CLOUD/MS/SE papers will be published in IEEE Transactions on Services (TSC, SCI & EI indexed), International Journal of Web Services Research (JWSR, SCI & EI indexed), or International Journal of Business Process Integration and Management (IBPIM).



IBM

IBM Research

SAP



HUAWEI



#### Submission Deadlines

ICWS 2013: 1/28/2013  
CLOUD 2013: 1/28/2013  
SCC 2013: 2/11/2013  
MS 2013: 2/11/2013  
SE 2013: 3/1/2013  
SERVICES 2013: 3/1/2013

Contact: Liang-Jie Zhang (LJ)  
[zhanglj@ieee.org](mailto:zhanglj@ieee.org)  
(Steering Committee Chair)



IEEE TRANSACTIONS ON  
SERVICES  
COMPUTING



## PERSPECTIVES

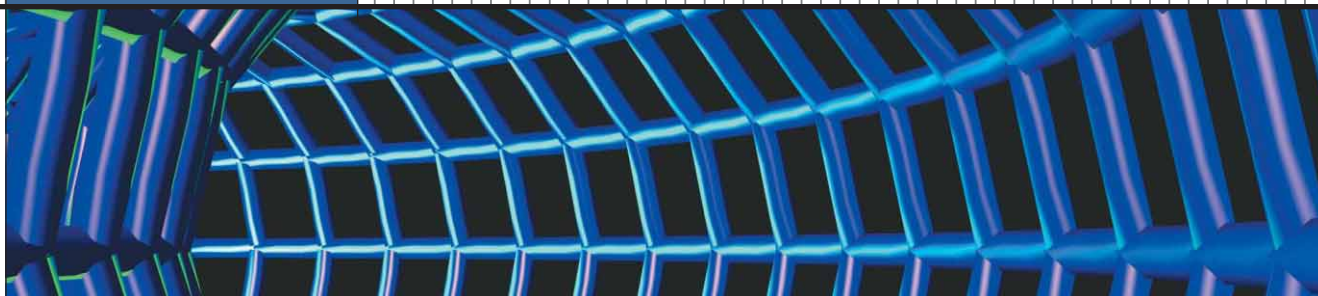

# Debugging on the Shoulders of Giants: Von Neumann's Programs 65 Years Later

Barry Fagin, *US Air Force Academy*

Dale Skrien, *Colby College*

**A study that examined and executed the programs John von Neumann wrote for the IAS machine reveals time-tested truths about computer architecture, side effects, instruction set design, and automatic programming—truths all foreseen by von Neumann and his team more than 50 years ago.**

**S**ome of the first computing programs ever written were to solve mathematical problems pertaining to the Institute for Advanced Study computer.<sup>1-5</sup> The IAS computer is intimately linked with John von Neumann, who led the IAS project team in Princeton, N.J., during the post-World War II era. Our analysis of these programs revealed several errors. Given that these programs have not been examined for well over 50 years after the only machine that could execute them was shut down, this is hardly surprising.

To conduct our investigation, we used an IAS machine emulator, developed originally for educational purposes so that users could write and execute programs in the original IAS instruction set.<sup>6</sup> Executing these programs reveals time-tested truths about computer architecture, side effects, instruction set design, and automatic programming—truths all foreseen by von Neumann and his team so many years ago.

The evidence suggests that at least a few of the programs, which appeared in both IAS technical reports and later in *John von Neumann: Collected Works*,<sup>5</sup> were never

directly executed on the machine as written. Allowing for typographical errors, at least a few of them contain non-trivial bugs. Our emulator validated corrected versions of all the programs in the original IAS reports,<sup>1-4,7</sup> producing the expected results.

## PROGRAMMING THE IAS MACHINE

A brief overview of how problems were solved on the IAS computer provides background for appreciating the intellectual achievements of von Neumann as well as of Arthur Burks, Herman Goldstine, and all others who worked at the Institute for Advanced Study.

The IAS computer consisted of a memory bank referred to as the Selectrons, an accumulator (A) capable of shifting, adding, and subtracting; and an arithmetic register (R), used, among other things, to hold double width results from multiplication and division along with the accumulator (these latter operations were accomplished through shifting and adding or subtracting). The machine also had the necessary support logic for reading and writing memory and for fetching and executing instructions from memory.

PERSPECTIVES

Table 1. IAS computer instruction set.

Inst #	Inst name	Abbrev	Description
1	S(x) → Ac +	x	Copy number in Selectron location x into A.
2	S(x) → Ac -	x -	Same as #1 but copy the negative of the number.
3	S(x) → AcM	xM	Same as #1 but copy the absolute value.
4	S(x) → Ac-M	x - M	Same as #1 but subtract the absolute value.
5	S(x) → Ah +	xh	Add number in Selectron location x into A.
6	S(x) → Ah -	xh -	Subtract number in Selectron location x from A.
7	S(x) → AhM	xhM	Same as #6, but add absolute value.
8	S(x) → Ah-M	xh - M	Same as #7, but subtract absolute value.
9	S(x) → R	xR	Copy number in Selectron location x into R.
10	R → A	A	Copy number in R to A.
11	S(x) * R → A	x ×	Multiply number in Selectron location x by the number in R. Place the left half of the result in A and the right half in R.
12	A/S(x) → R	x ÷	Divide the number in A by the number in Selectron location x. Place the quotient in R and the remainder in A.
13	Cu → S(x)	xC	Continue execution at the left-hand instruction at Selectron location x.
14	Cu' → S(x)	xC'	Continue execution at the right-hand instruction at Selectron location x.
15	Cc → S(x)	xCc	If the number in A is >= 0, continue as in #13. Otherwise, continue normally.
16	Cc' → S(x)	xCc'	If the number in A is >= 0, continue as in #14. Otherwise, continue normally.
17	At → S(x)	xS	Copy the number in A to Selectron location x.
18	Ap → S(x)	xSp	Replace the right-hand 12 bits of the left-hand instruction at Selectron location x by the right-hand 12 bits of A.
19	Ap' → S(x)	xSp'	Same as above, but modifies right-hand instruction.
20	R	R	Shift the number in A to the right 1 bit (left-most bit is copied).
21	L	L	Circularly left-shift the bits in A and R as an 80-bit quantity, leaving the most significant bit of A unchanged.

A: accumulator  
 Cc: control conditional (conditional branch in modern parlance)  
 Cu: control unconditional (unconditional branch or jump in modern parlance)  
 R: arithmetic register  
 S: Selectrons (memory in modern parlance)

All registers and data paths visible at the assembly language level were 40 bits wide.

Table 1 lists the basic instructions, referred to as *orders*. Some descriptions have been modified for clarity.

Programming the IAS required translating an algorithm originally expressed in the language of mathematics into a sequence of the instructions in Table 1.<sup>2</sup>

First, each programming problem began with a description of the algorithm in a combination of English and mathematics. The IAS mathematicians then translated this algorithm into a flow diagram like the one in Figure 1.<sup>2</sup>

Circles in Figure 1 indicate entry and exit points. Arrows indicate the flow of control. Boxes with two exit arrows are *alternative boxes*: they represent conditional branches, typically denoting loop exit points. A “+” denotes the path taken if the expression in the box is greater than or equal to zero, a “-” indicates the path if the expression is negative. Boxes with one entry and one exit point are *operation boxes* and are labeled with the mathematical description of the computations performed. In modern parlance, these are called basic blocks. Boxes labeled with “#” denote either *substitution boxes*, indicating changes to variables in memory, or *assertion boxes*, indicating certain valid mathematical relationships at the time the computation

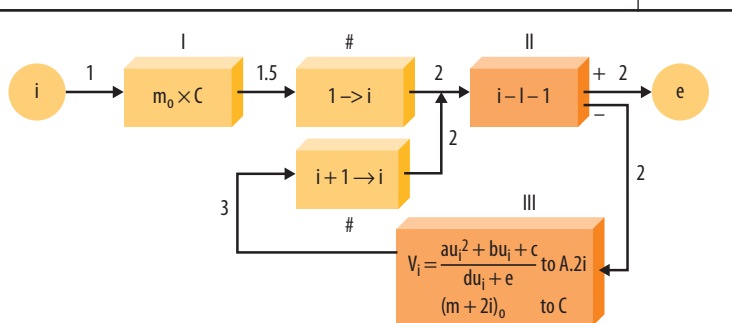

Figure 1. Flow diagram for an IAS computation.

traverses the box. Memory locations are indicated with capital letters and numeric suffixes.

In following Goldstine and von Neumann's translation process, once they believed the diagram to be complete, they labeled alternative and operations boxes with roman numerals, and obtained a preliminary enumeration of instructions. This process is roughly similar to the output a modern compiler might supply to a linker, in that it contains the necessary instruction sequence but with only symbolic memory addresses. Each line in a preliminary enumeration has at most three fields: a designator indicating the block from the flow diagram associated with the instruction and the instruction number within the block, a symbolic memory location, and an optional instruction abbreviation from Table 1 (if omitted, the instruction is assumed to be a load of the accumulator from the address).

The first few instructions from the preliminary enumeration of Figure 1 are as follows (we have added comments to aid understanding):

I,1	B.6		// load contents of memory location B.6 into the accumulator
.2	C	S	// store the accumulator into memory location C
II,1	C		// load C into accumulator
,2	B.7	h -	// subtract contents of memory location B.7 from accumulator
,3	e	Cc	// branch to exit point if accumulator >= 0
III,1	C		// load C into accumulator
,2	III,3	Sp	// Change the address field of the following instruction to the lower 12 bits of the accumulator
,3	-		// load from address as set by previous instruction

Once the preliminary enumeration is complete, the program's total size can be determined, which means that storage locations can be assigned (typically those immediately following the instructions), and branch targets filled in. IAS stores two instructions per memory word, and therefore pairs them into words at this stage. Based on the program's total size and the storage locations assigned, the instructions in the preceding preliminary enumeration become the four words in the following final enumeration. Whereas the 1947 reports used only abbreviations in preliminary and final enumerations, we have included the long forms to aid understanding.

WORD	INST PAIR	LONG FORM
0	19, 22S	S(x) -> A 19     A -> S(x) 22
1	22, 20h-	S(x) -> A 22     A -> A-S(x) 20
2	26Cc, 22	Cc -> S(x) 26     S(x) -> A 22
3	3Sp', -	Ap' -> S(x) 3     S(x) -> A -

From this point, an engineer would translate the final enumeration into binary and load the program into the Selectrons, presumably by setting toggle switches as dictated by the binary translation.

### THE IAS EMULATOR

The process of developing and eventually teaching a US Air Force Academy course on "Great Ideas in Computing" led to a search for tools that would permit students to program the original IAS computer. No such tools were found. However, CPU Sim, a general-purpose emulator, was available from Colby College (<http://www.cs.colby.edu/djskrien/CPUsim>).<sup>6</sup> Based on the descriptions of the machine and instruction set provided in the 1946-1947 documentation, we used CPU Sim to create IASSim, an emulator for the Princeton IAS computer. As Figure 2 shows, IASSim accepts text files containing long-form sequences of IAS instructions and executes them based on the semantics of Table 1. IASSim supports both single-step and start-to-finish execution mode, and it allows full inspection of all machine registers and memory.

We have used IASSim in support of graded classroom work. College freshmen with no prior computer science background have used it to program in IAS assembly language.<sup>8</sup>

Once the emulator was up and running, other uses beyond computer science education evolved. In particular, the existence of a functioning IAS emulator provides researchers with the opportunity to revisit the programming problems given in the 1947 IAS reports. As the IAS programs are among the oldest programs ever written, runnable on only one machine in the world, we believed it would be interesting to run them through the emulator to see which programs, if any, contained bugs.

### SOURCES OF ERROR IN PROGRAM TRANSLATION

Many steps are required to go from a 65-year-old algorithm description to a working program running on a 21st-century emulator. We performed all of the steps except the last one by hand, any one of which could introduce an error that would make the result incorrect. These steps were as follows:

1. Describe algorithm mathematically.
2. Depict algorithm in flow diagram.
3. Translate flow diagram into preliminary enumeration.
4. Transform preliminary enumeration into final enumeration.
5. Transcribe final enumeration from the 1947 technical reports in the 1963 edition of *John von Neumann: Collected Works*.
6. Enter program listing into emulator.
7. Execute program on emulator.

## PERSPECTIVES

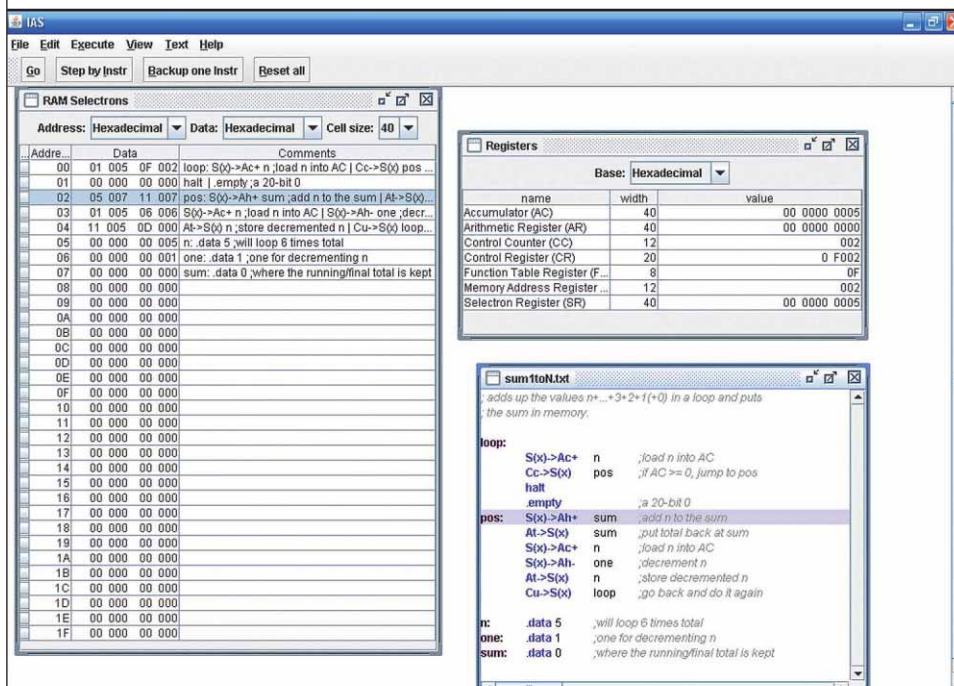

Figure 2. Screenshot from IASSim, an emulator for the IAS computer ([www.cs.colby.edu/djskrien/IASSim](http://www.cs.colby.edu/djskrien/IASSim)).

Von Neumann and his team would have performed steps 1-4 as part of the programming process. Steps 5-7 were added by the authors to support execution on the emulator.

We note that step 5 is not strictly necessary. We originally took our program listings from the Collected Works alone. When we eventually found errors, we compared the code with that in the original 1947 technical reports. Occasionally, we found programs in the original reports to be correct while the corresponding code in Collected Works was wrong, suggesting that copying or printing errors occurred when Collected Works was first compiled. Thus, we cite the transfer of code from the technical reports to Collected Works as a possible source of error.

## UNUSUAL FEATURES OF THE IAS MACHINE

The IAS computer contained a few features that are, by modern standards, somewhat unusual.

### Lack of I/O

The IAS machine had no I/O. This meant that users had to enter variables, as well as constants, by hand into specific memory locations. The program placed the results in memory locations, and engineers had to inspect them manually after program termination. This should be kept in mind when examining IAS program listings.

### IAS memory and instruction format

The IAS organized memory into 2,048 40-bit words. One of the machine's pioneering achievements is, of course,

the coresidence of data and instructions. Instructions, however, are 20 bits wide, with an 8-bit opcode and a 12-bit address. Thus, as the previous code example demonstrates, the IAS stores instructions in pairs, which requires making distinctions between the instructions in the left and right half of a word in branch targets. In Table 1, these are indicated with an apostrophe in the instruction notation. For example, Cc 30 means to conditionally branch to the instruction in the left half of the memory word 30, while Cc' 30 means the target is the instruction in the right half of the word. The IAS makes the distinction between the left or right "handedness" of instructions

during the translation of a preliminary enumeration to a final one.

## Number representation

The IAS represents integers in fixed-point binary 2's complement notation. The assumed binary point is to the immediate right of the most significant bit (the left-most bit). All numbers are 40 bits in length. Thus,  $\frac{1}{2}$  would be represented as the 40-bit quantity 0100 ... 000, and  $-\frac{5}{8}$  would be 10110 ... 000. The only numbers that can be represented in the machine, therefore, lie on the interval  $-1 \leq x < 1$ . Interestingly, 1 cannot be represented. The IAS engineers maintained accuracy by using appropriate rescaling of numbers when necessary, or by the programmer's having sufficient knowledge of the problem under study to pre-scale inputs appropriately and apply the correct postscaling to the results.

This representation scheme dictates the requirement that all data inputs to the machine, all intermediate quantities calculated during program execution, and all outputs must lie on the interval  $-1 < x < 1$ . Otherwise, the results might be incorrect.

The only exceptions to this representation scheme are numbers used to address memory, referred to as *position marks* (memory addresses in modern terminology). These numbers are 12 bits long. Since the IAS stores instructions in pairs, and each has a 12-bit address field, it is convenient to store these numbers as duplicated 12-bit patterns if the IAS performs address manipulation, so that instructions



and addresses in the left half of words need not be treated specially. Thus, the IAS would store the number 3 position mark as the 40-bit quantity  $0 \times 00-003-00-003$  (represented here in hexadecimal notation with hyphens separating address and opcode fields).

The original literature indicates position marks with a subscript of 0. Thus, if  $n = 6$ , an indication that  $(n - 1)_0$  should be stored in a given memory location does not refer to the number 5, since the IAS machine cannot represent 5. Instead, it represents the position mark  $0 \times 00-005-00-005$ .

### Self-modifying code

The IAS designers recognized early on that vector processing—the ability to perform the same computation on multiple data items—was an important requirement. The machine achieved this capability through self-modifying code, a programming technique generally frowned upon today.

Two special IAS instructions can modify the address field of memory words at a given address. Von Neumann referred to these instructions as “partial substitution orders,” or “substitution orders” for short. They are denoted as  $A_p$  and  $A_p'$  for modification of the left and right address fields in a word, respectively. These are instructions 18 and 19 from Table 1.

For example, consider the following IAS program fragment:

WORD	LONG FORM	HEX	INSTRUCTION
20	$A_p \rightarrow S(x) \ 50$	0x 12 032	: change address field of left inst at mem[50]
...			
50	$S(x) \rightarrow A_c + 0$	0x 01 000	; currently set to load accumulator from mem[0]

Suppose the lower 12 bits of the accumulator contain  $0x053$  when the instruction at memory location 20 is fetched. When it completes, instruction 50's address field will be modified to  $0x53$ . Thus, the program will now look like this:

20	$A_p \rightarrow S(x) \ 50$	0x 12 032	: change address field of left inst at mem[50]
...			
50	$S(x) \rightarrow A_c + 0$	0x 01 053	; will now load accumulator from mem[83]

Notice that instruction 50 has yet to execute; the effect of the address change will not be apparent until it does.

As von Neumann noted, the substitution orders are quite powerful. If they modify load and store instructions, they implement vector processing—but they can also modify branch instructions, in which case they dynami-

cally alter the sequencing of basic blocks in the program. The IAS can even use these instructions to manipulate data directly.

## VON NEUMANN'S ORIGINAL 15 PROGRAMMING PROBLEMS

Volume 2, part 1, of Goldstine and von Neumann's technical report, “Planning and Coding Problems for an Electronic Computing Instrument,”<sup>3</sup> contains nine programming examples; part 2 lists six more. The authors chose the examples, given in order of approximate increasing complexity, to illustrate the IAS machine's different problem domains and features.

We give a brief overview of each example and indicate whether Goldstine and von Neumann's programming solutions as given in the literature are correct. If a mistake existed in either the original reports or the *Collected Works*, we describe the nature of the error, how we believe the error originated, and show the necessary correction.

### A simple algebraic expression

Problem 1 is the simplest one, intended as an introduction to IAS features and the process of programming for it. Problem 1 calculates the value of the expression  $v = (au^2 + bu + c) / (du + e)$ , where  $a$  through  $e$  are constants and  $u$  is a user-supplied variable. The code as written is correct.

### Parameters and subroutines

Problem 2 is the same as problem 1, but now the code stores  $u$  and  $v$  at specific memory addresses, with  $v$  pointing to where the result will go. This is intended to illustrate the concept of parameters and subroutines. The code given is correct.

### Iteration

Problem 3 treats  $v$  as a function  $f(u)$  for which the program uses iteration to calculate multiple values. It stores each  $(u, v = f(u))$  pair in consecutive memory locations starting at memory address  $M$ . One interesting feature of this program is that it has a partial substitution order that modifies the instruction immediately after it:

WORD	LONG FORM	SHORT FORM
3	$A_p' \rightarrow S(x) \ 3$	3Sp'
	$S(x) \rightarrow A_c + -$	-

This partial substitution is a potential hazard since the program prefetches both instructions in a word simultaneously. We know from the literature that the IAS computer's design accounted for this possibility and therefore allowed it in programs.<sup>1</sup> The initial design anticipated the complications of data forwarding and delayed branching in modern pipelined architectures.

## PERSPECTIVES

The solution to problem 3 contains an error. As written in the original report, the instruction sequence at words 12 and 13 is:

WORD	LONG FORM	SHORT FORM
12	S(x)->Ah+ 6	16h
	A/S(x)->R 24	24÷
13	At->S(x) -	-S
	Cu->S(x) 1	1C

The problem is that the result of the division in the second instruction is left in the R register, but the second instruction must move it to the accumulator before the third instruction can store it in memory. The simplest correction is to insert two R → A instructions between words 12 and 13:

WORD	LONG FORM	SHORT FORM
12	S(x)->Ah+ 16	16h
	A/S(x)->R 24	24÷
13	R->A	
	R->A	
14	At->S(x) -	-S
	Cu->S(x) 1	1C
and soon	...	

This insertion in turn requires adjusting all target addresses from word 14 onward. In our case, the IASSim emulator's built-in assembler performs this task automatically.

Strictly speaking, although only one extra instruction is required, this would change the left-right parity of all the instructions in the words that follow, which would in turn require changing the parity of all branch instructions affected. We chose a simpler approach.

### Precalculation of scale factors

Problem 4 shows how to precalculate the appropriate scaling factor for a quotient  $u/v$  (the integer  $n$  such that  $2^{(n-1)} \leq (u/v) < 2^n$ ), without having to compute  $u/v$  explicitly. This would have been a common programming task on the IAS machine.

The only error in the listing appears to be typographical. Instruction 10 is written as  $35 - h$ , but should appear as  $35h -$ . This error appears in both the original reports and the *Collected Works*.

### Newton's method for calculating square roots

Problem 5 iterates  $z_{i+1} = \frac{1}{2}(z_i + u/z_i)$  from a starting estimate  $z_0$  until the limits of machine precision are reached. This converges to  $\sqrt{u}$ . The code as originally published is

correct; however, there is an error in the *Collected Works*, probably introduced during the transcription process. The instruction in the left half of word 5 is written as 9h in the original IAS report, but is incorrectly rendered in the *Collected Works* as 0h.

### Binary to binary-coded decimal conversion

Problem 6 is the IAS code to convert a number in standard IAS floating-point format to IAS binary-coded decimal (BCD) format. As originally published, the instruction pair at word 11 has the branch parities reversed. The simplest correction is to switch the targets (which would make the second branch a noop). The code was originally written as 12Cc', 3C'. Changing the instruction pair to 3Cc', 12C corrects the code.

### BCD to binary conversion

Problem 7 is similar to problem 6, but converts from BCD to binary. The published solution has three minor errors and one logic error. The minor errors are as follows:

WORD	AS WRITTEN	SHOULD READ	SOURCE OF ERROR
24	17S, 48	17S, 43	<i>Collected Works</i>
35	42S, 36Cc	42S, 26Cc	IAS report, <i>Collected Works</i>
38	41Cc', A	39Cc', A	IAS report, <i>Collected Works</i>

The first two are probably typographical errors, since they differ only by one digit. The correction to the third error is consistent with the flow diagram given in the IAS report,<sup>3</sup> and so the error would have been introduced after that point in the compilation process.

In addition, there is a logic error between instruction words 26 and 27:

WORD	LONG FORM	SHORT FORM
26	At->S(x) 42	42S
	S(x)->Ac+ 17	17
27	L	L
	L	L

The L instructions (left shift) occur in a loop, and have the side effect of moving bits into the R register. In one part of the program, this side effect is needed, but in this particular part it is not. The instruction at word 27 uses these left shifts only to multiply the accumulator by 4, and the remaining parts of the program will not work correctly if the L instructions at word 27 alter the R register in any way.

The easiest fix is to insert a pair of  $S(x) \rightarrow R$  43 instructions between words 26 and 27, since according to the text

memory, location 43 contains 0. This has the effect of clearing R:

WORD	LONG FORM	SHORT FORM
26	At->S(x) 42	425
	S(x)->Ac+ 17	17
27	S(x)->R 43	43R
	S(x)->R 43	43R
28	L	L
	L	L

As with earlier examples, only one instruction is strictly necessary, but inserting a pair of identical instructions is simpler. Similarly, the usual adjustment of target addresses is required.

A legitimate question is whether the implementation of different semantics for the L instruction would make the published solution correct and that we are simply applying the wrong ones. Different semantics for different IAS instructions were indeed known and published (for example, in the IAS reports, changes are evident from volume 1 to volume 2). However, in this case the L instruction was changed to modify the R register precisely to support binary to decimal conversion, which this example was intended to illustrate.

For the emulator, we chose the semantics for all IAS instructions given in volume 2, part 1, the same report in which these problems were published.<sup>3</sup> We are aware of no consistent semantics for the L instruction that make the published listing work correctly for this problem. With the proposed correction, the code runs on the emulator exactly as described, correctly converting numbers in IAS BCD format to their floating-point representations.

### Double-precision sum

The code in problem 8 sums two 80-bit IAS numbers and is correct as written.

### Double-precision floating-point product

The code in problem 9 multiplies two 80-bit IAS numbers and is correct as written.

### Numerical integration via Simpson's rule

The problems from volume 2, part 2, are substantially more complex,<sup>4</sup> and were chosen to illustrate the power and broad applicability of the electronic stored-program computer.

Problem 10 numerically integrates a function supplied as  $N + 1$  values  $f(x)$  on the closed interval  $x = [0..1]$ . The code as written is correct. There is only a minor printing error in the *Collected Works*, which lists the contents of memory location 21 as  $2N/3$  but should instead be written as  $2/3N$ . The annotation is correct in the IAS report.

### Numerical integration via Simpson's rule, subset of points

Problem 11 is similar to problem 10, except that the boundaries of a subinterval of the function values are used as boundaries for integration. These are assumed to be the problem parameters. The code as originally written in the IAS report is correct; however, two minor printing errors appear in the *Collected Works* as follows:

WORD	As printed in vol. 2, part 1 (Correct)	As later printed in <i>Collected Works</i> (incorrect)
14	34, 26Sp'	34., 26Sp'
23	-, - h	-, -h

### Lagrangian interpolation

Problem 12 uses Lagrangian interpolation to calculate the coefficients of the unique polynomial of degree  $M - 1$  that passes through  $M$  points  $(x_1, p_1) .. (x_M, p_M)$ , and then evaluates that polynomial for some given  $x$ . The code is correct.

### Three problems using Lagrangian interpolation for a tabulated function

Problem 13 is divided into three subproblems, each showing different ways to use problem 12's code to interpolate a tabulated function. For these problems, there are  $N \gg M$  points  $(p_1, y_1) .. (p_N, y_N)$ . The computer is first used to find the index  $k$  of  $M$  points starting with  $y_k$  that are closest to the value of a given variable  $y$ . The program then passes this index value to the code of problem 12 to evaluate the function at  $y$ .

For problem 13a, we assume the points to be equidistant, which means that the computer stores only the total number and the endpoints. For problem 13b, the points are not equidistant, which means that the emulator must store all points explicitly. Problem 13c is identical to 13b except that the  $p_i$  and  $y_i$  values alternate in memory instead of being stored as a vector of  $p$ 's followed by a vector of  $q$ 's.

Problem 13a has at least two logic errors. To perform a certain arithmetic operation, the code uses three substitution orders at various places:

WORD	LONG FORM	SHORT FORM
64	Ap'->S(x) 52	52Sp'
	...	
69	...	
	Ap->S(x) 50	50Sp
72	Ap->S(x) 51	51Sp
	...	

## PERSPECTIVES

For this operation to have the desired effect, the indicated memory locations must be zero before the emulator alters them (recall that substitution orders replace only parts of words). Even if we assume that memory locations that are not explicitly initialized begin with default values of zero, two of the three referenced locations above are sinks of previous instructions, so at least two of them are incorrect.

The easiest correction is to find two memory locations we can explicitly initialize to zero without further affecting the program. A review of the code shows the program can use the memory locations 48 (C.1), 49 (C.2), and 50 (C.1.1), which means the instruction in the right half of word 69 can remain unaltered. Thus, if the program explicitly initializes memory locations 48–50 to zero, the following changes will make the code correct:

WORD	LONG FORM	SHORT FORM
64	Ap->S(x) 48	48Sp'
	...	
69	...	
	Ap->S(x) 50	50Sp
72	Ap->S(x) 49	49Sp

Problem 13b suffers from the same deficiency. The solution, however, is more elaborate, because the affected substitution orders now occur in a loop. This requires explicitly clearing the memory locations during program execution.

The affected sequence of instructions follows, grouped by pairs for clarity:

WORD	SHORT FORM
81	42h, 65Cc
82	49, 50h
83	51Sp', 51
84	R, 51Sp
85	51h, 48S

To ensure that memory location 51 is cleared before the substitution order at 83, the program inserts a load from a memory location set to zero. In this case, it uses the lowest-numbered memory location not in use, which according to the listing is #52. For the order at 84, however, that will not work, because the next instruction needs the value in the accumulator. Since the program only needs to explicitly clear the lower half of the word in this context (the upper half is already zero), the easiest solution is to insert an Ap' substitution order. The program then follows it with a duplicate order as a noop to preserve the parities of the branch targets that follow. The following is a comparison of the original and corrected code:

WORD	ORIGINAL	CORRECTED
81	42h, 65Cc	42h, 65Cc
82	49, 50h	52, 51S
83	51Sp', 51	49, 50h
84	R, 51Sp	51Sp', 51
85	51h, 48S	R, 51Sp'
		51Sp', 51Sp
		51h, 48S

The insertion of two extra instruction words requires incrementing all word addresses from 85 and beyond by 2. The code as corrected above produces the desired solution on the emulator.

Problem 13c has the same errors as problem 13b. The complete listing was not given in the original report, only those changes necessary from the code of 12 and 13b. Making those changes coupled with the corrections above requires suitably modifying the branch targets. Other than that, the code is correct.

There is a printing error in the listing for this problem in the *Collected Works*. Instruction pair 53 reads 93, 62Sp but should read 93, 62Sp'. The listing is correct in the original report.

### Merging two lists

The IAS authors deliberately chose problems 14 and 15 to be less mathematical in nature and more suggestive of data processing. Clearly, von Neumann anticipated the powerful nonmathematical applications of digital computing.

Problem 14 inductively merges two lists of records. What the report calls a “complex,” we now call a record. A “sequence” is a list in modern terminology, and a “principal number” is a key.

The listing contains what is probably a typographical error. The instruction in the second half of word 26 reads 10Cc', but should read 10C' (replacing a conditional branch with an unconditional one). With this change, the code runs correctly.

### Sorting a list

Problem 15 uses the problem 14 code to inductively sort a list by first merging successive pairs of lists of size 1, then merging half again as many lists of size 2, and so on. List sizes that are not powers of two are accommodated. The only error is the same one in problem 14. With that correction, the code runs correctly.

## LESSONS FOR COMPUTER SCIENTISTS TODAY

Revisiting the computational problem-solving processes first outlined in the 1947 IAS technical reports offers both a trip back in time and a prescient glimpse into the future of computing. Many of the issues computer scientists would

later grapple with, and continue to wrestle with today, can be seen in microcosm by retracing the process from flow diagram to emulated result. Four issues are particularly noteworthy.

### Programming automatization

Bridging the semantic gap between mathematics and electrical impulses was an intellectually demanding and error-prone process, even for the most brilliant minds of the post-World War II era. All of the IAS examples began with correct mathematics, but the lack of automatic tools to support the necessary transitional steps from flow diagrams to bits led to the inevitable introduction of errors, paradoxically due to both the complexity and the tedium of the work required. As more hardware became available, researchers began to meet this need for transitional steps in the 1960s with assembly language, assemblers, high-level languages, and compilers, but the need to further remove human error from the programming process remains vital today. Once humans have indicated the problems they want their computing devices to solve, the less involvement they have with that process, the better.

### Formal methods

Related to the previous point, it is clear that von Neumann anticipated the use of more formal mathematical techniques in the programming process, even if he could not employ them as extensively as he might have preferred. Much of the historical delay was probably due to the prodigious increase in the number of computer programmers and mathematicians. Based on his writing, we suspect von Neumann would have viewed that trend negatively. He wrote, for example, that the inclusion of a floating point in the machine would have been a mistake, both because of the complexity and because it encouraged a lack of mathematical rigor. If a user did not know to within a power of two what the correct result of his computation should be, he probably didn't understand the problem well enough to be using the machine.

However, formal methods might now be maturing to a point that would have gladdened von Neumann's heart. Work is ongoing, for example, on an implementation of a Domain Name System server that uses Ada and the SPARK program analysis toolset to prove the absence of runtime exceptions.<sup>9</sup> These tools require users to insert assertions at various points in the code to indicate what properties should hold there. The analogy to the assertion boxes of von Neumann's original flow diagrams is immediately apparent.

### Simplicity and orthogonality in instruction set design

Related to the lack of programming tools that were available for the IAS machine, many of the errors we found were due to side effects, inconsistent semantics, and lack

of orthogonality in interaction among IAS instructions. Reasoning about side effects such as changing register values, shifting bits from one register into another, and having some instructions modify others is notoriously difficult. Adding support at the instruction-set level for specific computational tasks like binary-to-decimal conversion as the IAS machine did seems similar, for example, to the use of the POLY instruction in the VAX 11/780 40 years later.<sup>10</sup> It appears to significantly complicate the hardware, and it makes correct programming at the assembly language level more challenging.

The emergence of reduced-instruction-set computer architectures in the 1980s might be seen as a response to concerns about the orthogonality and side effects in instruction set design, as well as the implementation and refinement of more complex instruction sets in terms of simpler micro-operations. Achieving the correct balance between hardware and firmware may be a perpetual challenge for computer science.

### The challenge of testing a nonexistent computer

None of the codes in the IAS technical reports could have been tested when they were published in 1947, since their target machine was not fully functional until five years later. Obviously, emulation was not an option, so the researchers could rely only on their vision of how the machine would work. Under those circumstances, the relatively small number of errors in the codes is quite remarkable.

**A** third IAS technical report, which we have not yet fully investigated, introduces two more programming problems.<sup>7</sup> These are not specific mathematical tasks per se, but instead illustrate subroutining, linking, and loading—tasks that were automated in later decades. We propose using IASSim to investigate these problems as a topic for future work.

Finally, although we understand that the computer science curriculum is already quite challenging, our exploration into the IAS machine makes us wonder if some sort of exposure to older machines might make sense for future computer designers. After all, those who do not learn from computer history are condemned to repeat it. **■**

### References

1. A.W. Burks, H.H. Goldstine, and J. von Neumann, "Preliminary Discussion of the Logical Design of an Electronic Computing Instrument," *Report to US Army Ordnance Department*, Inst. for Advanced Study, 1946.
2. H.H. Goldstine and J. von Neumann, *Planning and Coding Problems for an Electronic Computing Instrument*, vol. 1, part 2, Inst. for Advanced Study, 1947.
3. H.H. Goldstine and J. von Neumann, *Planning and Coding Problems for an Electronic Computing Instrument*, vol. 2, part 1, Inst. for Advanced Study, 1947.

## PERSPECTIVES

4. H.H. Goldstine and J. von Neumann, *Planning and Coding Problems for an Electronic Computing Instrument*, vol. 2, part 2, Inst. for Advanced Study, 1947.
5. A.H. Taub, ed., "Design of Computers, Theory of Automata and Numerical Analysis," *John von Neumann: Collected Works*, vol. V, Macmillan, 1963.
6. D.J. Skrien, "CPU Sim 3.1: A Tool for Simulating Computer Architectures for Computer Organization Classes," *ACM J. Educational Resources in Computing*, Dec. 2001, pp. 46-59.
7. H.H. Goldstine and J. von Neumann, *Planning and Coding Problems for an Electronic Computing Instrument*, vol. 3, part 2, Inst. for Advanced Study, 1947.
8. B.S. Fagin and D.J. Skrien, "IASSim: A Programmable Emulator for the Princeton IAS/Von Neumann Machine," *Proc. 42nd ACM Technical Symp. Computer Science Education (SIGSE 11)*, ACM, 2011, pp. 359-364.
9. M. Carlisle and B. Fagin, "Creating a Provably Secure DNS Server," tech. report, US Air Force Academy Center for Cyberspace Research, Mar. 2011.
10. W.D. Strecker, "VAX-11/780—A Virtual Address Extension to the DEC PDP-11 Family," *Proc. Nat'l Computer Conf., AFIPS*, 1978, pp. 967-979.

**Barry Fagin** is a professor of computer science at the US Air Force Academy. His research interests are computer science education, computing and public policy, and using formal methods to improve internet security. He received a PhD in computer science from the University of California, Berkeley. Fagin is a member of ACM and is an IEEE Senior Member. Contact him at [barry.fagin@usafa.edu](mailto:barry.fagin@usafa.edu).

**Dale Skrien** is a professor of computer science at Colby College. His research interests include algorithmic graph theory, object-oriented design, and computer music. Skrien received a PhD in mathematics from the University of Washington. He is a member of ACM. Contact him at [djskrien@colby.edu](mailto:djskrien@colby.edu).



Selected CS articles and columns are available for free at <http://ComputingNow.computer.org>.



IEEE *Computer Graphics and Applications* bridges the theory and practice of computer graphics. From specific algorithms to full system implementations, *CG&A* offers a unique combination of peer-reviewed feature articles and informal departments. *CG&A* is indispensable reading for people working at the leading edge of computer graphics technology and its applications in everything from business to the arts.

Visit us at [www.computer.org/cga](http://www.computer.org/cga)

# IEEE computer society

**PURPOSE:** The IEEE Computer Society is the world's largest association of computing professionals and is the leading provider of technical information in the field.

**MEMBERSHIP:** Members receive the monthly magazine *Computer*, discounts, and opportunities to serve (all activities are led by volunteer members). Membership is open to all IEEE members, affiliate society members, and others interested in the computer field.

**COMPUTER SOCIETY WEBSITE:** [www.computer.org](http://www.computer.org)

**OMBUDSMAN:** To check membership status or report a change of address, call the IEEE Member Services toll-free number, +1 800 678 4333 (US) or +1 732 981 0060 (international). Direct all other Computer Society-related questions—magazine delivery or unresolved complaints—to [help@computer.org](mailto:help@computer.org).

**CHAPTERS:** Regular and student chapters worldwide provide the opportunity to interact with colleagues, hear technical experts, and serve the local professional community.

**AVAILABLE INFORMATION:** To obtain more information on any of the following, contact Customer Service at +1 714 821 8380 or +1 800 272 6657:

- Membership applications
- Publications catalog
- Draft standards and order forms
- Technical committee list
- Technical committee application
- Chapter start-up procedures
- Student scholarship information
- Volunteer leaders/staff directory
- IEEE senior member grade application (requires 10 years practice and significant performance in five of those 10)

## PUBLICATIONS AND ACTIVITIES

**Computer:** The flagship publication of the IEEE Computer Society, *Computer*, publishes peer-reviewed technical content that covers all aspects of computer science, computer engineering, technology, and applications.

**Periodicals:** The society publishes 12 magazines, 15 transactions, and one letters. Refer to membership application or request information as noted above.

**Conference Proceedings & Books:** Conference Publishing Services publishes more than 175 titles every year. CS Press publishes books in partnership with John Wiley & Sons.

**Standards Working Groups:** More than 150 groups produce IEEE standards used throughout the world.

**Technical Committees:** TCs provide professional interaction in more than 45 technical areas and directly influence computer engineering conferences and publications.

**Conferences/Education:** The society holds about 200 conferences each year and sponsors many educational activities, including computing science accreditation.

**Certifications:** The society offers two software developer credentials. For more information, visit [www.computer.org/certification](http://www.computer.org/certification).

**NEXT BOARD MEETING**  
5–6 Nov., New Brunswick, NJ, USA



revised 18 Oct. 2012

## EXECUTIVE COMMITTEE

**President:** John W. Walz\*

**President-Elect:** David Alan Grier\*

**Past President:** Sorel Reisman\*

**VP, Standards Activities:** Charlene (Chuck) Walrad†

**Secretary:** Andre Ivanov (2nd VP)\*

**VP, Educational Activities:** Elizabeth L. Burd\*

**VP, Member & Geographic Activities:** Sattupathuv Sankaran†

**VP, Publications:** Tom M. Conte (1st VP)\*

**VP, Professional Activities:** Paul K. Joannou\*

**VP, Technical & Conference Activities:** Paul R. Croll†

**Treasurer:** James W. Moore, CSDP\*

**2011–2012 IEEE Division VIII Director:** Susan K. (Kathy) Land, CSDP†

**2012–2013 IEEE Division V Director:** James W. Moore, CSDP†

**2012 IEEE Division Director VIII Director-Elect:** Roger U. Fujii†

\*voting member of the Board of Governors †nonvoting member of the Board of Governors

## BOARD OF GOVERNORS

**Term Expiring 2012:** Elizabeth L. Burd, Thomas M. Conte, Frank E.

Ferrante, Jean-Luc Gaudiot, Paul K. Joannou, Luis Kun, James W. Moore, William (Bill) Pitts

**Term Expiring 2013:** Pierre Bourque, Dennis J. Frailey, Atsuhiko Goto,

André Ivanov, Dejan S. Milojevic, Paolo Montuschi, Jane Chu Prey, Charlene (Chuck) Walrad

## EXECUTIVE STAFF

**Executive Director:** Angela R. Burgess

**Associate Executive Director; Director, Governance:** Anne Marie Kelly

**Director, Finance & Accounting:** John Miller

**Director, Information Technology & Services:** Ray Kahn

**Director, Membership Development:** Violet S. Doan

**Director, Products & Services:** Evan Butterfield

**Director, Sales & Marketing:** Chris Jensen

## COMPUTER SOCIETY OFFICES

**Washington, D.C.:** 2001 L St., Ste. 700, Washington, D.C. 20036-4928

**Phone:** +1 202 371 0101 • **Fax:** +1 202 728 9614

**Email:** [hq.ofc@computer.org](mailto:hq.ofc@computer.org)

**Los Alamitos:** 10662 Los Vaqueros Circle, Los Alamitos, CA 90720

**Phone:** +1 714 821 8380

**Email:** [help@computer.org](mailto:help@computer.org)

## MEMBERSHIP & PUBLICATION ORDERS

**Phone:** +1 800 272 6657 • **Fax:** +1 714 821 4641 • **Email:** [help@computer.org](mailto:help@computer.org)

**Asia/Pacific:** Watanabe Building, 1-4-2 Minami-Aoyama, Minato-ku, Tokyo 107-0062, Japan

**Phone:** +81 3 3408 3118 • **Fax:** +81 3 3408 3553

**Email:** [tokyo.ofc@computer.org](mailto:tokyo.ofc@computer.org)

## IEEE OFFICERS

**President and CEO:** Gordon W. Day

**President-Elect:** Peter W. Staecker

**Past President:** Moshe Kam

**Secretary:** Celia L. Desmond

**Treasurer:** Harold L. Flescher

**President, Standards Association Board of Governors:** Steven M. Mills

**VP, Educational Activities:** Michael R. Lightner

**VP, Membership & Geographic Activities:** Howard E. Michel

**VP, Publication Services & Products:** David A. Hodges

**VP, Technical Activities:** Frederick C. Mintzer

**IEEE Division V Director:** James W. Moore, CSDP

**IEEE Division VIII Director:** Susan K. (Kathy) Land, CSDP

**IEEE Division VIII Director-Elect:** Roger U. Fujii

**President, IEEE-USA:** James M. Howard

## RESEARCH FEATURE

# China's Indigenous Innovation Policy: Impact on Multi-national R&D

Jason Dedrick and Jian Tang, *Syracuse University*  
Kenneth L. Kraemer, *University of California, Irvine*

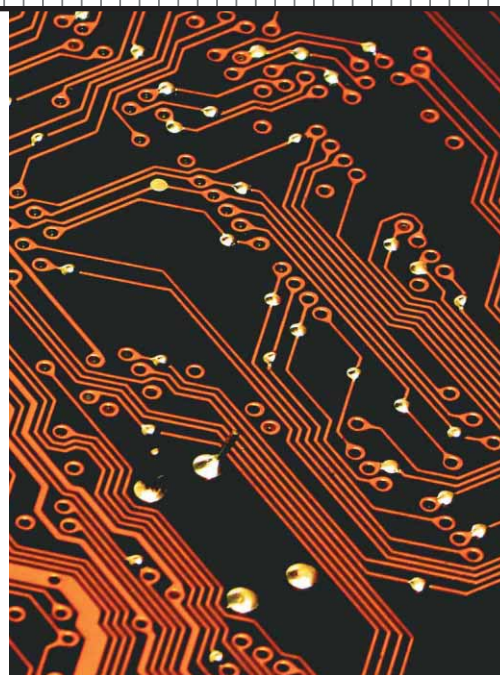

**Multinational corporations seeking access to China's burgeoning consumer markets and human resources are establishing R&D centers in the country and developing ways to thread a path through its complex innovation policies.**

**R**ecently, the growth of R&D in emerging economies such as Brazil, Russia, and particularly India and China, has captured the attention of researchers.<sup>1</sup> Collectively called BRIC economies, these large and growing markets also produce many relatively low-cost scientists and engineers. To develop products for these markets, and to tap their skilled human resources, multinational corporations (MNCs) are setting up R&D labs in these countries and in some cases outsourcing R&D activities to local firms.

China has a strong desire to learn from MNCs, while developing domestic companies that can compete globally and reduce China's dependence on foreign intellectual property (IP). The resulting indigenous innovation policies have raised alarm among MNCs, which complain that these policies can be arbitrary and unfair to foreign companies.<sup>2</sup>

Based on a review of the literature and interviews conducted in China in 2009, we asked the following questions:

- What are the objectives of China's indigenous innovation policies, and how is China translating these objectives into specific regulations and initiatives?
- What factors influence MNC R&D activities in China, and what is the impact of China's indigenous innovation policies?
- How do MNCs manage R&D in China within the context of their global organizations?

The answers to these questions offer an introduction to China's innovation policies and the R&D activities and strategies of foreign MNCs in China.

## EMPIRICAL RESEARCH

We studied China's indigenous innovation policies, and the decisions and activities of major MNCs in the information and communication technology industry in China. We also interviewed a dozen R&D executives at five large US MNCs, executives of IT industry associations, and US government officials in China.

Table 1 provides background information on each of the MNCs. We do not reveal company names at their request.

## CHINA'S INDIGENOUS INNOVATION POLICIES

China is now the leading manufacturer of many electronics products, assembling advanced PCs, mobile phones, networking equipment, and other high-tech goods. Yet only a few Chinese companies are globally competitive in any of these industries, and MNCs or Taiwanese companies produce most exports. As a result, although China plays a major role in the global IT industry, it captures a small share of the profits in the value chain.<sup>3</sup>

China's government leaders want to move into higher value activities such as R&D, particularly the development



**Table 1. Background information for companies in the study.\***

Characteristic	MNC 1	MNC 2	MNC 3	MNC 4	MNC 5
Industry sector	Computers, software, and services	Computers	Software	Semiconductors	Mobile communications
No. of employees in China	20,000	> 10,000	4,000	7,000	10,000
No. of R&D employees in China	6,000 total; 300 PhDs	< 100 researchers plus interns and postdoctoral candidates	2,000 total, 250 in research labs	> 1,200 hardware and software engineers	1,000 to 2,000

\* From company documents and interview notes.

of new products and advanced technologies.<sup>4,5</sup> Starting in the mid-1980s, China instituted a series of policies to promote domestic technology development for commercial markets.<sup>6</sup> These policies helped domestic enterprises and promoted innovation in the PC, electronics, software, integrated circuit, and telecommunications equipment industries.

China's five-year 2006 to 2010 plan further targeted the information industry by focusing on indigenous innovation. It emphasized

- developing domestic standards and technologies,
- promoting innovation in IT products, and
- supporting domestically owned technology firms.

At the same time, China announced a 15-year "Medium-to-Long-Term Plan for the Development of Science and Technology," which called for the country to become an innovation-oriented society by 2020 and a world leader in science and technology by 2050.<sup>7</sup>

A statement by Zhang Dejiang, a member of the Political Bureau of the Communist Party and vice prime minister, captures the motivation behind these policies ([www.miit.gov.cn/n11293472/n11293877/n13702866/n13702883/14206919.html](http://www.miit.gov.cn/n11293472/n11293877/n13702866/n13702883/14206919.html)):

Under the guidance of Decisions of Accelerating the Growth and Development of Strategic Emerging Industries, it is important to enhance the policy support and strengthen the capability of indigenous innovation, especially to make the IT industry to be the leading industry. ... It is also essential to continue supporting TD-SCDMA [time division synchronous code division multiple access, a standard], and encourage the industrialization and internationalization of TD-LTE [time division, long-term evolution].

### Promoting domestic standards and technologies

China seeks to develop IP and core technologies, and views technical standards as crucial to its success.<sup>8,9</sup> It has been working hard to push Chinese standards as international standards. For example, the government selected TD-SCDMA to be the 3G mobile standard of China Mobile

(China's largest mobile carrier), and the International Telecommunication Union has approved it as a global standard.<sup>6,10</sup>

The government clearly uses the standards-setting process as a tool to support domestic companies. Establishing domestic standards reduces the competitive advantage of MNCs, which use technologies based on international standards.

MNCs have been involved in some Chinese standards initiatives, such as TD-SCDMA, the Audio Video Standard (AVS), and the Intelligent Grouping and Resource Sharing (IGRS) protocol, a home networking standard.<sup>10</sup> But MNCs are not involved in other standards, such as the Wireless LAN Authentication and Privacy Infrastructure (WAPI). It would be fair to say that China sees the importance of participating in global standards bodies as well as the value of involving MNCs in its own standards forums.

In the longer run, China seeks to become a leading player in international standards bodies, but plans to do so from a position of internationalizing its own national standards as well as localizing international standards.<sup>10</sup> The MNCs realize that they will need to adopt China's standards in some cases if they want to participate in the Chinese market, so they attempt to influence those standards when possible.

The desire to promote domestic standards rather than just adopt international standards might put China behind in adopting some technologies. For example, its promotion of TD-SCDMA for 3G mobile phone service and the decision to require China Mobile to adopt the standard left China years behind other countries in rolling out 3G mobile phone service. Yet the government was willing to pay that price to promote a domestic standard and ensure that domestic equipment manufacturers such as Datang, a state enterprise under the China Academy of Telecommunication Technology, would have a leading role in the 3G market.<sup>10</sup>

### Promoting domestic innovation

To promote domestic innovation, the government offers tax incentives and other financial benefits to domestic and foreign firms that set up R&D centers in China. To be eligible for these benefits, firms must seek certification, which means they must

## RESEARCH FEATURE

- register in mainland China (which does not include Hong Kong, Macau, and Taiwan),
- engage in R&D,
- develop independent IP in core technologies, and
- file patents in China.<sup>9</sup>

Most certified firms are domestic companies, as the requirements are problematic for foreign firms. According to one interviewee, the head of an IT industry organization, “There are some high-profile cases where companies left China or chose another location in Asia, such as the Philippines, because of the IP laws and certification requirements.” Other MNCs conduct R&D in China without receiving certification or the associated incentives.

The government also adopted measures to speed technology development and transfer, including financial support, tax incentives, IP protection, and domestic R&D centers. It also required more technological investments from MNCs, including R&D centers that engage in research collaboration with local researchers and institutions. Our interviews indicate that China anticipates that domestic researchers in these collaborations will have access to advanced technologies from the MNCs.

### China’s indigenous innovation policy gives preference to domestic companies in procurement by government agencies and state-owned enterprises.

#### Supporting domestic firms

China’s indigenous innovation policy gives preference to domestic companies in procurement by government agencies and state-owned enterprises. Regulations state that “If government departments purchase software related to national sovereignty or economic security, they should follow the procedure of government procurement” and give preference to local companies.<sup>9</sup>

China also promotes national champions to act as a counterbalance to the market power of MNCs in specific sectors; it also encourages these champions to become innovators capable of competing globally.<sup>2</sup> As one interviewee said, “China’s strategy is to create one strong player in each industry segment and to build them up to dominate the China market and prepare them to go global. They do not care about creating competition among local companies, and they want to protect these companies from foreign competition.” However, having national champions does not mean that these sectors are competition free. For example, Huawei competes at home and abroad with ZTE in networking equipment, while Lenovo, China’s leading PC maker, faces both domestic and foreign competitors in

the PC market. Even favored state enterprises often face competition in the sectors they dominate.<sup>11</sup>

#### Bureaucratic competition in policy implementation

Although outsiders might see China’s government as a unified actor making policies that affect the MNCs, the reality is much different—the state’s role can be ambiguous and is not always unified.<sup>10</sup> Several central government institutions implement indigenous innovation policies; each institution has different agendas, as do provincial and city governments.<sup>4</sup>

The key central government agencies are the Ministry of Science and Technology (MOST), the National Development and Reformation Committee (NDRC), and the Ministry of Education.<sup>2</sup> The Ministry of Industry and Information Technology (MIIT) is a key agency in the information industry. The Standardization Administration of China (SAC) leads in developing standards policies. According to interviewees, there is inconsistency and sometimes conflict among central government agencies. This might reflect not only institutional rivalry, but also the personalized nature of many policy processes in China, which only increases the level of uncertainty and ambiguity in policy outcomes.<sup>4</sup>

Policy objectives can also differ between the central and local governments. For example, the central government sets the certification criteria that define a high-tech company, whereas local governments certify individual companies. MNCs seek high-tech certification because it reduces the corporate income tax from 25 to 15 percent. For certification as a high-tech company, an MNC’s local subsidiary should perform R&D and file patents in China. However, most local governments mainly want jobs and have been willing to certify MNCs as high-tech companies without strict adherence to the criteria. As one interviewee stated, “Local governments are not fussy about what they label as R&D in their reports to the central government, so a wide variety of activities end up being called R&D.”

As another interviewee stated, “The local governments are under pressure to stimulate high-tech industry, so they attract companies that appear on the surface to be doing high-tech work although in reality they might not be doing so. Although the central government is concerned about the long-term impact and the development of indigenous R&D, local governments are not.”

The result of competition among localities for investment and jobs is the emergence of a regionalized high-tech industry, with major regions specializing in different aspects of production and innovation.<sup>4</sup> For example, Beijing hosts MNCs and domestic firms specializing in software development and is the home to many MNC R&D labs, as well as Lenovo. The industry is concentrated in the Zhongguancun Science Park, a development supported by the central and Beijing municipal governments.<sup>12</sup>

The Shanghai area hosts several MNC R&D labs and is home to both MNCs and domestic semiconductor and telecommunications companies. Shanghai's municipal government has played a key role in developing science parks and promoting the local IT industry.<sup>4</sup>

The Pearl River Delta in southern China hosts the largest concentration of hardware manufacturing, including the massive Foxconn campus near Shenzhen, which makes products for Apple, HP, Dell, Intel, and others. It is also home to China's greatest homegrown high-tech success story, Huawei, a network equipment company.

## FACTORS INFLUENCING R&D DECISIONS

Key factors influencing the location of MNC investment in overseas R&D include a large domestic market, availability of low-cost R&D manpower, and the scale of national technology capabilities. There is no clear evidence that R&D incentives offered by foreign governments have an impact on R&D intensity or that adverse policies (such as inadequate patent protection or restrictive trade regimes) affect the attractiveness of a country for R&D.<sup>13</sup>

Our interviews support prior research by showing that MNCs are attracted to China primarily by the size of the domestic market and the availability and low cost of R&D talent.<sup>14</sup> However, China's technological capabilities do not appear to be an important attraction; its perceived weak protection of IP rights might limit the types of R&D activities conducted there.

### Domestic market

The size and growth rate of China's economy make it a unique attraction for MNCs, leading them to make concessions that they might not make in other markets. For example, China has as many mobile phone users as the combined populations of the US and the European Union (about 800 million), and has an estimated 538 million Internet users. China's economy is larger than the combined GDPs of the other three BRIC economies. A continuation of the double-digit growth of the past three decades could make China the world's largest economy in less than 20 years.

At the same time, it is difficult for foreign companies to enter China's market. Obstacles include inadequate physical and financial infrastructure in many places, lack of enforceable commercial laws, weak IP protection, heavy competition from domestic firms with lower costs, and an array of government restrictions on the activities of all companies, particularly foreign companies. In the words of one interviewee, "Policy is everything and is arbitrary. One day you can do [a type of] business, the next day they say, 'Sorry, you can't.'"

Despite these issues, the Chinese market is so attractive that MNCs must be there. The representatives of four of five MNCs we interviewed mentioned market access as a major reason for locating R&D in China. The fifth men-

tioned market growth as a reason for manufacturing in China, and cited specific market opportunities for product development in the country.

How does this market potential translate into a need for R&D in China? One factor is understanding market needs. One general manager stated that "China is valuable for R&D because the economy is huge and growing bigger, and the customers have unique [scale] requirements. By being in China, we can gain an edge over competitors because we understand these requirements better than others."

The Chinese market also has some characteristics that create novel R&D opportunities for MNCs. For example, China bans sales of most videogame consoles, and only a few retail outlets sell games. Instead, consumers can download games from government-approved websites. One company said that this created a potential market for technology that accelerates downloads and leads to performing related work in its China R&D lab.

**Key factors influencing the location of MNC investment in overseas R&D include a large domestic market, availability of low-cost R&D manpower, and the scale of national technology capabilities.**

Another interviewee pointed to the potential for research opportunities that take advantage of the vast amount of data that certain events can generate in China, such as Web traffic during the 2008 Olympics. For technologies such as large-scale data mining or managing network capacity during huge spikes in traffic, China can serve as a unique research environment.

### R&D talent availability and cost

Access to China's large pool of science and engineering graduates is a major factor for most MNCs locating R&D in China. China's universities and colleges produce an abundance of graduates in science and engineering. Although most of these graduates are not of the caliber that MNCs require, MNCs select from the cream of the crop—the top 0.5 percent, according to one company, or the top 10 schools, according to another.

Competition for talent has increased as more MNCs enter the market, along with Taiwanese and mainland Chinese companies. According to several interviewees, state-owned enterprises, once unattractive to talented graduates, now offer competitive salaries and better benefits—such as subsidized housing—compared with MNCs. In addition, the prestige of working for an MNC has somewhat diminished.

This competition has led to salary increases, especially for experienced scientists and engineers, as well as for managers. Although competition is becoming more intense

## RESEARCH FEATURE

and salaries are increasing, the quality of graduates has also improved.

One interviewee said, “People used to get PhDs in two to three years. No research methodology, just theory. Now the education system has improved. They have numerous professors with degrees from the US and experience in US universities. The gap is much smaller than it was.”

The biggest shortage is in middle managers and higher-level leaders who can run a project or an entire division. There are few people with 10 to 15 years’ experience in China, and bringing experienced personnel from the US is expensive. Salaries for people with 15 years’ experience are comparable to those in other locations such as Ireland or Israel, according to one interviewee. One solution to finding experienced people is to hire Chinese nationals who have studied and worked in the US or other locations to manage teams in China.

**Although MNCs might look for incentives or subsidies, the bigger motivation is to gain favor from government officials.**

Despite increased competition and cost, as well as shortages in some skills, the availability and quality of science and engineering talent is clearly a major attraction for firms doing R&D in China. Cost is mentioned less often, but it is an advantage. To be clear, although salaries are rising in China, there is still a huge gap compared with the US. As of 2005, a newly graduated computer engineer in China could expect to start at \$7,500 to \$10,000 a year, while in the US, the figure was around \$60,000.<sup>15</sup>

### INFLUENCE OF CHINA’S POLICIES ON MNC STRATEGIES

China’s policies in general have a major influence on the decisions of MNCs to locate R&D in China. As one interviewee said, “Most companies are doing only as much as the government forces them to. Market access requires doing R&D in China.”

Although MNCs might look for incentives or subsidies, the bigger motivation is to gain favor from government officials. In the words of a former R&D director for a major MNC, “The main reason that MNCs come to China is cheap labor, but it is also to have influence with the government so that these companies can participate in large Chinese government procurements or in the consumer market. If companies play the game right, they can get considerable help from the government in many different forms.”

China’s indigenous innovation policies seem to have a

weaker and mixed effect on MNCs. Companies are generally unhappy with some requirements, but have been willing to expand their R&D activities in China in spite of those concerns. When incentives are available, they seek certification as high-tech companies. In general, they do better with local governments than with the central government.

A US official said, “The central government offers subsidies to domestic companies for indigenous development of technology. But there is no clear definition of what a domestic company is.”

The policy of requiring IP registration in China for firms that desire treatment as domestic companies is a major concern to some MNCs, less so to others. This difference might relate to differences in the firms’ strategies, whether they seek incentives, or the extent to which they focus on the government and SOE markets.

According to one interviewee,

Registering IP in China doesn’t fit with a global operations model, where R&D is done in a unified way. How do you justify having some part of it coming from China, and how do you protect it if you do define some part as from China? The business issue is this: Do the benefits of licensing in China, like tax benefits, potential sales, goodwill with the government, outweigh the IP risk?

On the other hand, another US MNC said that it had obtained certification as a high-tech company. The company indicated that the Chinese government defined the criteria in advance, and the company reports performance every year. This company has made a major commitment to China as a manufacturing and product development location, as well as a market, so potential tax incentives are especially valuable.

Some MNCs have been more aggressive in challenging China’s policies and trying to involve the US government. Others try to keep a low profile and avoid possible retaliation from the Chinese government. The most visible and contentious issues in the past have been over IP protection—for example, from software piracy—standards setting, and content censorship.

MNCs were successful in acting together to challenge MIIT’s 2009 order that all new PCs come with Green Dam software installed to block certain Internet content. The MNCs argued that this was an unreasonable requirement, and eventually MIIT dropped the requirement. This success came largely because the MNCs allied themselves with Chinese PC makers and consumers, and with the US and other governments. In contrast, Google shut down its mainland China search engine for a time after being unable to resolve censorship issues. In this case, the US government was powerless to influence China’s position in spite of criticism from the US secretary of state.

**Table 2. Motivation, activities, and management of China R&D.**

Characteristics	MNC 1	MNC 2	MNC 3	MNC 4	MNC 5
<b>Factors influencing R&amp;D location in China</b>					
Key motivations for R&D in China	Market access, understand market, influence policy, access to talent	Market access, understand market needs, access to talent	Win government favor and support for IP protection	Market access, low-cost talent, be a "good citizen"	Win government favor, develop China as major market, tap local talent
<b>MNC interaction with the local innovation system</b>					
Local partnerships	University-focused: hire talented students, joint projects	Joint R&D projects with universities	Industry and university focused, outsourced software development	Joint R&D projects and education programs	Industry focused
IP policies	IP managed globally	IP managed globally, share IP from joint projects	IP managed globally	IP managed globally, share IP from joint research	IP registered in China and globally if developed in China
Response to indigenous innovation policy	Try to influence and shape policy behind the scenes	Does not seek treatment as domestic company	Developing local outsource suppliers, attract R&D to China	Built a fabrication plant, increased R&D activity	Certified as high-tech company for lower tax rate
<b>China R&amp;D strategy</b>					
R&D activities in China	Development and testing for global teams, localization	Localization, potential to develop technology for global market	Research and develop technologies for global business units	Develop extensions of existing technologies for local market, possible use in other markets; testbed for unique conditions	Development for local market, development and test for global projects
Management control	Limited control, decisions made in US or elsewhere	Limited control, decisions made in US	Independent projects, integrated into global projects; business units are all represented in China lab	Matrixed organization reporting to local management and corporate teams	Lead some global projects, compete with other global labs

In the case of indigenous innovation, US MNCs made a major issue of discrimination in the procurement aspects of the policy and obtained support from the US government in negotiating with China on the issue. Possibly as a result, the Chinese government announced changes in its policy during President Hu's state visit to Washington in January 2011. Specifically, the Chinese promised to delink indigenous innovation from government procurement ([www.reuters.com/article/idUSTRE70J7RL20110121](http://www.reuters.com/article/idUSTRE70J7RL20110121)).

The White House described the agreement as follows ([www.whitehouse.gov/the-press-office/2011/01/19/fact-sheet-us-china-economic-issues](http://www.whitehouse.gov/the-press-office/2011/01/19/fact-sheet-us-china-economic-issues)):

- The US and China agreed that government procurement decisions will not be made based on where the goods' or services' IP is developed or maintained, that there will be no discrimination against innovative products made by foreign suppliers operating in China, and that China will delink its innovation policies from its government procurement preferences.
- China agreed to eliminate discriminatory indigenous innovation criteria used to select industrial equipment

for an important government catalogue prepared by MIIT, to ensure that it will not be used for import substitution, the provision of export subsidies, or to discriminate against American equipment manufacturers in Chinese government programs targeting these products.

**MNC R&D STRATEGIES IN CHINA**

As Table 2 shows, MNC strategies have focused primarily on using low-cost talent to exploit their technology assets by localizing existing products to the Chinese market rather than developing technologies for global markets. However, R&D activities have evolved as local scientists and engineers have gained experience and capabilities, as well as the confidence of corporate management. Although no China lab has the independent authority enjoyed by more established labs in Europe, Japan, or Israel, some have begun to move in that direction.

**MNC 1: Computers, software, and services**

The China R&D group in MNC 1 focuses on localization of products for China and on testing for the whole

## RESEARCH FEATURE

corporation. It thus works on a broad scope of technologies, but MNC 1 still limits its role to a small part of the R&D process. This R&D group does not act autonomously, but is under the control of corporate R&D management. According to one MNC 1 interviewee,

China R&D does product R&D for our whole corporate business model. China does the test phase and some localization; architectural design and business development and delivery models are all done by units outside China. We invest a lot rotating people in China through the various labs. In the future, some development and business direction may shift to China, but decisions about product offerings and positioning of the product will be decided outside China.

### MNC 2: Computers

In MNC 2, the China lab serves the company's business units and participates in development for those units rather than in research. However, there is some room for local initiative, with the possibility of developing technologies for use in the parent company.

**IP developed in partnership with local universities is jointly owned; the company files patents in China as well as the US.**

"[MNC 2] is close to [our] business units. We develop demos that the business units request. We also develop demos based on our own imagination and show them to the business units."

IP developed in partnership with local universities is jointly owned; the company files patents in China as well as the US. As one interviewee said, "Patenting is not different in China from elsewhere. [We] have experienced, professional people in the company to help with patenting."

### MNC 3: Software

MNC 3 operates as an independent R&D unit serving the firm's global businesses. All of the company's business units are present in the China lab and operate independently of each other, working on their own projects. The lab director referred to this as a federated model. This company has a heavy focus on basic research and operates its China lab accordingly, "hiring top researchers and leaving them alone," according to the director.

MNC 3 also does a substantial amount of software localization and outsources to local firms as part of an agreement with the government. The goal is to help China

develop a domestic outsourcing industry that is competitive with India.

### MNC 4: Semiconductors

MNC 4 has been aggressive in trying to transition from little more than a satellite operation created for public relations to an independent lab on par with other leading labs outside the US.

The director of research at MNC 4 stated that the company's R&D had gone through four phases since it first established a lab in China 10 years ago. At first, MNC 4 was just trying to "give back to China," as it had been making a lot of money there.

In the initial phase, Chinese engineers were well behind the skills of their counterparts in other countries. They thus worked on software that was for internal use only, not for the company's products. In the second phase, teams in the US sent tasks to the China lab for the development of designs initiated in the US. In the third phase, some senior engineers in China could initiate a project, but the team in China could not carry out the entire project. The current fourth phase is a shift to developing an independent R&D lab capable of carrying out complete projects to develop technologies for use in China and other markets.

### MNC 5: Mobile communications

MNC 5 has a history of extensive R&D activity in China, a major market and operational center for the company. Its R&D labs are part of a global network, and the company expects that China will move from a following to a leading role over time. According to the R&D director,

Our different R&D centers around the world coordinate and compete with one another. The R&D centers try to get involved in projects rather than just wait to be chosen. Each business unit looks at R&D globally and decides where it wants to do things. If the cost of other locations is too high, they're likely to grow more in China. Our R&D center's mission is to transition R&D from localization and support to development projects and then to projects for some global markets.

## EXPECTATIONS AND IMPLICATIONS

The MNCs in this study conduct R&D in China primarily because China's government at least implicitly expects such investment in exchange for market access and favorable treatment. Some seek to exploit China's large pool of low-cost talent; others see market opportunities for their products and services as well as learning opportunities that they can apply to other large emerging markets. They also seek to meet the special requirements of local customers.

These R&D centers seldom operate independently of an MNC's business units or its other R&D units. Most perform a well-proscribed development function within this larger

framework, usually more development and testing than actual research. R&D management outside China, usually in the US, determines their activities. However, a trend toward greater autonomy is arising at some companies.

### Implications for MNCs

China is serious about becoming a center for indigenous innovation, so MNCs must carefully consider whether and how to develop R&D there.

It is true that China generally favors domestic firms in many policy decisions. Although it is convenient to see a dynamic that pits the Chinese government against the MNCs as a group, the reality is much more complex. Various central ministries as well as provincial and local governments set and implement Chinese policies, and they do not always coordinate efforts.

MNCs can sometimes thread a path through the system and benefit from favorable treatment, especially from provincial and local governments, which are more interested in receiving investment than in enforcing indigenous innovation policies. On the other hand, it is difficult for MNCs to know where they stand; one institution might overturn another's approval.

### Lessons learned

Several lessons come from the experience of the MNCs in this study. Some apply to all firms, whereas others depend on a specific firm's circumstances in China.

Although government agencies and state-owned enterprises are a difficult market to break into, MNCs continue to anticipate that their share of domestic business will increase as China grows. They sometimes compare China to Japan and Korea, where protectionist economies have gradually opened up, and MNCs have grown their businesses with domestic companies. This confidence appears to be justified by the performance of firms with greater experience in China. In a recent survey, only 42 percent of US companies with less than two years in China reported China operations were profitable or very profitable. In contrast, that figure was 81 percent for firms with 10 to 20 years in China, and 76 percent for firms with more than 20 years' experience.<sup>16</sup>

But China is also different in many ways. Japan and Korea encourage competition among private domestic companies as well as with foreign MNCs, whereas China promotes national champions in many sectors. In the long run, domestic companies are likely to become competitive in more industries both at home and globally.

A key issue for foreign MNCs is to balance a realistic view of market potential against the risks of exposing IP through R&D in China's complex and uncertain environment. An interesting case is Apple, which has no R&D in China, yet has seen its sales there quadruple in one year. China ranks as Apple's second largest market, accounting for 16 percent of

global sales in 2011 ([www.bloomberg.com/news/2011-10-19/china-becomes-apple-s-second-largest-market-by-sales-cook-says.html#](http://www.bloomberg.com/news/2011-10-19/china-becomes-apple-s-second-largest-market-by-sales-cook-says.html#)). Whether Apple can sustain its growth without committing to R&D in China remains to be seen.

One lesson from the history of MNCs in China is that an MNC should not individually challenge policies that it finds unacceptable. China does not need any individual MNC, but it does need MNCs as a group to help achieve its technology goals. So the government sometimes reconsiders when facing complaints from several MNCs, especially when these firms can rally local allies, as in the Green Dam case. MNCs can also solicit pressure from the US or other governments, especially when a policy is inconsistent with international rules.

Google's experience highlights the risks of a direct challenge to the government by a single company. China's rich complexity requires that MNCs develop a highly nuanced strategic approach. MNCs must balance helping to advance China's goals in return for market access without giving up their own sources of competitive advantage.

**B**ecause of strong motivations to invest in R&D regardless of policies, it appears that in many cases, China's indigenous innovation policies do not matter. Companies with experience in China continue to prosper. As Apple's experience demonstrates, even new entrants that have products Chinese consumers want can do very well. Indigenous innovation policies might even benefit MNCs that have a strong commitment to China, but those companies must be very careful about exposing IP to take advantage of government incentives. **□**

### References

1. Y. Sun, M. Von Zedtwitz, and D.F. Simon, "Globalization of R&D and China: An Introduction," *Asia Pacific Business Rev.*, vol. 13, no. 3, 2007, pp. 311-319.
2. J. McGregor, "China's Drive for 'Indigenous Innovation': A Web of Industrial Policies," US Chamber of Commerce, 2010; [www.uschamber.com/sites/default/files/reports/100728chinareport.pdf](http://www.uschamber.com/sites/default/files/reports/100728chinareport.pdf).
3. G. Linden, K.L. Kraemer, and J. Dedrick, "Who Captures Value in a Global Innovation Network? The Case of Apple's iPod," *Comm. ACM*, Mar. 2009, pp. 140-144.
4. D. Breznitz and M. Murphree, *Run of the Red Queen: Government, Innovation, Globalization and Economic Growth in China*, Yale Univ. Press, 2011.
5. M. von Zedtwitz, "Managing Foreign R&D Laboratories in China," *R&D Management*, Sept. 2004, pp. 439-452.
6. A. Segal, *Advantage: How American Innovation Can Overcome the Asian Challenge*, W.W. Norton and Co., 2011.
7. C. Cao, R.P. Suttmeier, and D.F. Simon, "China's 15-Year Science and Technology Plan," *Physics Today*, Aug. 2006, pp. 38-43.
8. G. Linden, "China Standard Time: A Study in Strategic Industrial Policy," *Business and Politics*, vol. 6, no. 3, 2004, pp. 1-26.

## RESEARCH FEATURE

9. Ministry of Information Industry, "Guidance of Accelerating Independent Innovation in Information Industry," Sept. 2006; [www.gov.cn/zwggk/2006-09/01/content\\_375841.htm](http://www.gov.cn/zwggk/2006-09/01/content_375841.htm) (in Chinese).
10. R.P. Suttmeier, X. Yao, and A.Z. Tan, *Standards of Power? Technology, Institutions, and Politics in the Development of China's National Standards Strategy*, Nat'l Bureau of Asian Research, 2006.
11. B. Naughton, "China's Economic Policy Today: The New State Activism," *Eurasian Geography and Economics*, May/June 2011, pp. 313-329.
12. Y. Zhou and T. Xin, "An Innovative Region in China: Interaction between Multinational Corporations and Local Firms in a High-Tech Cluster in Beijing," *Economic Geography*, Apr. 2003, pp. 129-152.
13. N. Kumar, "Determinants of Location of Overseas R&D Activity of Multinational Enterprises: The Case of US and Japanese Corporations," *Research Policy*, Jan. 2001, pp. 159-174.
14. Y. Sun, "Strategic or Tactical? Foreign Research and Development in Developing Countries: A Case Study of China," *Asian Geographer*, vol. 22, nos. 1-2, 2003, pp. 143-167.
15. J. Dedrick and K.L. Kraemer, "Impact of Globalization and Offshoring on Engineering Employment in the Personal Computer Industry," *The Offshoring of Engineering: Facts, Unknowns, and Potential Implications*, Committee on the Offshoring of Engineering, Nat'l Academies Press, 2008, pp. 125-136.
16. AmCham-China, *American Business in China*, American Chamber of Commerce in China, 2011.

**Jason Dedrick** is an associate professor in Syracuse University's School of Information Studies. His research interests include the globalization of technology and innovation, global value chains in the electronics and wind energy industries, national technology policies, and the economic and organizational impacts of IT. Dedrick received a PhD in management from the University of California, Irvine. Contact him at [jdedrick@syr.edu](mailto:jdedrick@syr.edu).

**Jian Tang** is a doctoral student in Syracuse University's School of Information Studies. Her research interests include IT use and evaluation (especially from the ecological psychology perspective) and the information industry and innovation policies in developing countries. Tang received a BA in information management and information systems from Renmin University in Beijing, China. Contact her at [jtang04@syr.edu](mailto:jtang04@syr.edu).

**Kenneth L. Kraemer** is a research professor at the Paul Merage School of Business and codirector of the Personal Computing Industry Center, University of California, Irvine. His research interests include the social implications of IT, national policies for IT production and use, the contributions of IT to productivity and economic development, and the value of innovation in global innovation and production networks. Kraemer received a PhD in public policy and management from the University of Southern California. Contact him at [kkraemer@uci.edu](mailto:kkraemer@uci.edu).

computing now

## NEW+EXPANDED

IEEE COMPUTER SOCIETY'S **COMPUTING NOW** WEBSITE

Learn industry solutions you can use from practical articles, case studies, blogs, and interviews that address high-interest, focused areas of technology.

Mobile Computing • Cloud Computing • Security • Software • High-Performance Computing • Networking



IEEE computer society

Visit <http://computingnow.computer.org>



## GREEN IT

# Sustainable IT: Challenges, Postures, and Outcomes

**Edward Curry**, *National University of Ireland, Galway*

**Bill Guyon**, *Intel*

**Charles Sheridan**, *Intel Labs Europe*

**Brian Donnellan**, *National University of Ireland, Maynooth*



**Sustainable IT capabilities benefit not only the environment but also business value.**

**S**ustainability is an important business issue, affecting new products and services, compliance requirements, cost-reduction opportunities, reputation, and revenue generation. Many people think that incorporating sustainable practices requires a significant transformational program, but the ultimate goal is to embed sustainability into business-as-usual activities.

Researchers have estimated that information and communications technology (ICT) is responsible for at least 2 percent of global greenhouse gas emissions, with datacenters accounting for about 1.3 percent. In any individual business, ICT accounts for a much higher percentage of its carbon footprint.

Yet, researchers also estimate that ICT can reduce an organization's carbon footprint fivefold. To leverage these benefits, many corporate IT departments are now looking to develop sustainable IT capabilities. Unfortunately, these organizations often don't exploit IT's full potential in their efforts to achieve sustainability.

## SUSTAINABLE IT CHALLENGES

Despite an increasing profile and tangible, measurable benefits, there remain numerous misconceptions about sustainable IT—that it's simply about saving the planet and isn't a business issue; that it's driven by compliance; that it only concerns energy savings, the datacenter, or what goes on in IT's own arena; and that it's expensive to implement.

Businesses considering sustainable IT face many questions:

- Does the organization recognize IT as a significant contributor to its overall sustainability strategy?
- How does IT contribute to the organization's sustainability goals?
- What more could IT do to contribute to those goals?
- Are there clear, measurable objectives for sustainable IT?

The issue is further complicated by the fact that sustainability is an enterprise-wide issue that spans the full value chain. The business already has

challenges in developing clear business strategies, which might not fully address sustainable IT. This puts the onus on the IT department to deliver the benefits of sustainable IT across the organization.

## SUSTAINABLE IT FRAMEWORK

Sustainability is still a relatively new, complex subject with few guidelines and best practices. Those responsible for achieving sustainable IT can feel like they are pioneers in uncharted territory with no map to guide them. This means that once they've reached certain milestones, it's unclear where they should go next and how far along the journey they are.

To address this issue, a consortium of leading organizations from industry, the nonprofit sector, and academia have developed a framework for improving sustainable IT capabilities (B. Donnellan, C. Sheridan, and E. Curry, "A Capability Maturity Framework for Sustainable Information and Communication Technology," *IT Professional*, vol. 13, no. 1, 2011, pp. 33-40).

**GREEN IT**

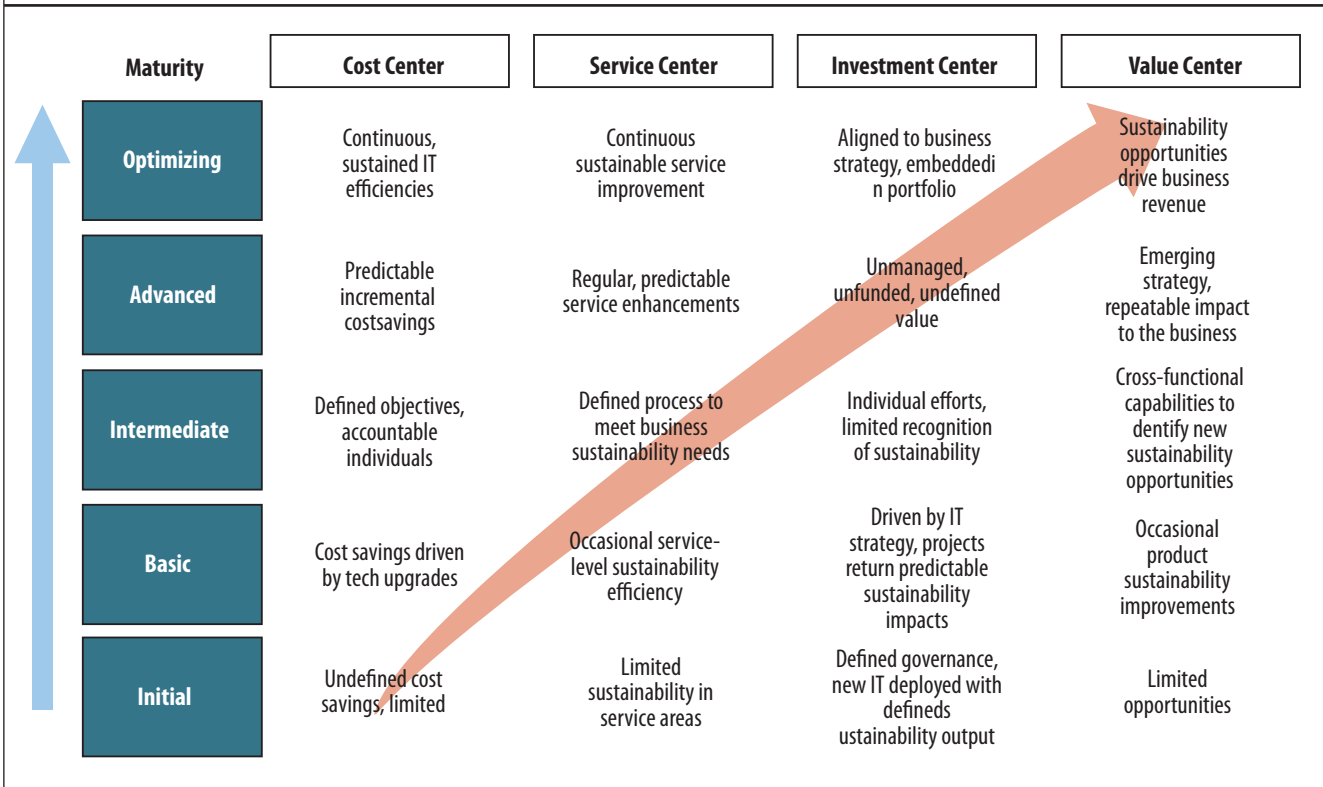

**Figure 1. The four basic IT postures at varying sustainable IT maturity levels.**

This framework serves two important purposes. First, it's the basis of an assessment process that helps an organization determine the current maturity level of their sustainable IT efforts. Second, it provides a view of the growth path by identifying the next set of capabilities an organization should develop to drive greater business value from sustainable IT.

The framework defines a maturity curve with five levels—initial, basic, intermediate, advanced, and optimizing—for sustainable IT capabilities including strategy and planning, processes management, people and culture, and governance.

**IT POSTURES AND SUSTAINABILITY**

Sustainable IT goes beyond using IT to reduce energy consumption. It's also about helping the whole business meet its sustainability targets. This greatly extends IT's scope from simply executing the IT design-procure-run-dispose life cycle

more efficiently to aligning business with IT and identifying those sustainability processes where IT can contribute.

When defining sustainable IT practices and capabilities, it's important to consider their potential value from the vantage point of different IT postures within the organization. There are four basic sustainable IT postures:

- the *cost center* manages the direct sustainability costs within the IT arena, with only indirect benefits for the business;
- the *service center* focuses on the sustainability of IT services supplied to support the business;
- the *investment center* delivers predictable sustainability benefits across both IT and the business; and
- the *value center* leverages sustainable IT as a strategic asset to drive sustainable business opportunities as a competitive differentiator.

Figure 1 compares these postures at the five sustainable IT maturity levels.

Regardless of its posture, IT can realize business value by maturing in the area of sustainable IT. However, IT's posture will determine the maximum achievable business value over time. For example, as long as IT's posture is a cost center, no matter how much it matures, it will always emphasize improving efficiencies. However, shifting to a service center posture could help IT get its foot into the business side of value. An effective sustainable IT program can help IT reposition itself from the viewpoint of both customers and management.

**SUSTAINABLE IT AT INTEL**

Intel has long recognized sustainability as a strategic priority for its company and has become a recognized leader in the space. At the beginning of 2008, CEO Paul Otellini set out an ambitious five-year plan to reduce environmental impacts in several areas, including energy, water,

and reduction of carbon emissions by 20 percent on 2007 levels.

Seeing this as an opportunity for IT to play a key role in achieving the company's sustainability goals, CIO Diane Bryant established the IT Sustainability Program. The program used an investment posture to help the business deliver on its objectives by reducing the environmental impacts of IT operations, and to help transform the overall organization (E. Curry et al., "Developing a Sustainable IT Capability: Lessons From Intel's Journey," *MIS Q. Executive*, Jan. 2012, pp. 61-74).

One of the primary ways Intel IT reduced its carbon footprint was through server consolidation in its datacenters. While chip performance doubles every 18 months, the energy consumed by the chip does not double. Moore's law thus drives continuous chip-level energy efficiency, meaning that newer servers and laptops use less power than older machines to do the same work.

Intel IT has settled on a four-year server refresh policy, which has allowed it to double processing capacity and reduce costs. Together with an aggressive server virtualization strategy and improved management of workload distribution among servers, Intel IT has reduced the number of servers from 100,000 to 75,000.

The program also helped the whole company to reduce its carbon footprint. In 2011, Intel had more than 91,500 employees across 164 sites in 62 countries. These employees would typically work in distributed and virtual teams. Intel IT made extensive use of collaboration technology to reduce the need for employees to travel. In 2010 and 2011, video conferencing efforts saved employees 435,000 travel hours—a cost savings of more than US\$114 million and an environmental savings of more than 87,500 metric tons of CO<sub>2</sub> emissions.

By the end of 2011, Intel had reduced the carbon emissions of its IT operations by 60 percent compared

to 2007. During the same time period, IT's computing processing capacity increased 159 percent, storage increased from 18.6 to 38.2 petabytes, and network bandwidth increased from 3.0 to 6.2 gigabits per second—all while delivering IT services to an additional 11,000 employees. Moreover, Intel's annual revenue rose by 41 percent.

**I**ntel IT's experience demonstrates that choosing an appropriate posture for sustainable IT, together with a structured methodology to maturing that capability, can deliver tangible financial and environmental savings, all while assisting businesses to meet their overall sustainability targets. **C**

*Edward Curry is a research scientist at the Digital Enterprise Research Institute, National University of Ire-*

*land, Galway. Contact him at [edward.curry@deri.org](mailto:edward.curry@deri.org).*

*Bill Guyon is a program manager at Intel's IT Sustainability Program Office. Contact him at [bill.guyon@intel.com](mailto:bill.guyon@intel.com).*

*Charles Sheridan is the associate director of Intel Labs Europe's Energy and Sustainability Research Lab. Contact him at [charles.g.sheridan@intel.com](mailto:charles.g.sheridan@intel.com).*

*Brian Donnellan is the academic director of the Innovative Value Institute, National University of Ireland, Maynooth. Contact him at [brian.donnellan@nuim.ie](mailto:brian.donnellan@nuim.ie).*

**Editor: Kirk W. Cameron, Dept. of Computer Science, Virginia Tech; [greenit@computer.org](mailto:greenit@computer.org)**

**cn** Selected CS articles and columns are available for free at <http://ComputingNow.computer.org>.



## CONFERENCES in the Palm of Your Hand

IEEE Computer Society's Conference Publishing Services (CPS) is now offering conference program mobile apps! Let your attendees have their conference schedule, conference information, and paper listings in the palm of their hands.

The conference program mobile app works for Android devices, iPhone, iPad, and the Kindle Fire.



For more information please contact [cps@computer.org](mailto:cps@computer.org)





## OUT OF BAND

# Stratfor or Stratagainst

Hal Berghel

University of Nevada, Las Vegas



Based on what you know about WikiLeaks and Stratfor, which group seems to be the greater threat to society?

**N**early one year has passed since WikiLeaks released Stratfor's internal email via the hacktivist group, Anonymous. By now, this story should have inspired public discussions on any number of fronts: journalistic ethics, whether private intelligence-gathering companies that use bribery to gain privileged information from politically exposed persons (PEPs) should fall under the Foreign Corrupt Practices Act, and whether governments and their employees should be held accountable for supporting such activities, to name but a few. Yet the current crop of thought leaders appears to be avoiding any potentially important policy issues that might underlie this incident.

## BLACK OPS NGOS

Stratfor illustrates the post-9/11 wave of private cybermercenaries—for-profit organizations that sell cyberservices to risk-averse and fearful businesses and governments. Although the psychology behind this mindset may be the more interesting topic and will likely be the subject of social science treatises, essays, and monographs for decades, we'll limit our present discussion to the cyber side of things.

The missions behind the current crop of cybermercenaries seem to fit within the following continuum:

1. *intelligence gathering*—basically the same investigation plus analysis activities usually associated with law enforcement, perhaps with an increased level of sophistication in real-time reporting and analysis, just-in-time briefings of impending events, back-end data mining, and so forth. This activity may involve illegal behavior such as the bribery, extortion, and blackmail of PEPs.
2. *cyberespionage and cybersurveillance*—again, basically what law enforcement does, only privately and with neither oversight nor court orders.
3. *cyberweapons manufacturing or deployment*—either licensed to clients or used offensively by developer.

From what I can tell from the WikiLeaks documents, Stratfor is primarily in the first group—along with HBGary Federal (now part of ManTech) and Palantir on their best behavior. The third group is also easy to populate (thanks again to the Anonymous folks). Players in this space include HBGary and the Gamma Group. The second group is harder to define because it draws talent from the other groups. For example, as the “URL Pearls” sidebar describes, some of the software developed by HBGary and the Gamma Group was designed for cyber-

espionage and cybersurveillance, and some of the activities of Stratfor, HBGary, and Palantir under such innocuous-sounding rubrics as “predictive policing” involve surveillance.

It should be noted that the activities in (1) and (2) fall within the domain of statutory investigative agencies such as the police and FBI. I note here that accurate classification of cybermercenaries is difficult for outsiders because of the secrecy under which they operate—well outside the sphere of statutory authority and beyond the reach of the media—kind of like a National Security Agency but without the tax support.

This parallels the proliferation of corporate mercenaries—private armies, private military contractors, private security contractors—such as Academi (formerly Xe Services, Blackwater) and Triple Canopy. For the moment, the cyber side seems to remain largely decoupled, but I predict that, in time, these interests will converge into one-size-fits-all, general-purpose private army/police/intelligence-for-hire concerns. Experiments at such integration have already occurred—see the Computer Sciences Corporation, which owned the private military contractor DynCorp from 2003 to 2005. Not surprisingly, as Figure 1 indicates, some of these companies have been known to target WikiLeaks.

The Stratfor website states that “Stratfor is a subscription-based provider of geopolitical analysis. ... Unlike traditional news outlets, Stratfor uses a unique, intelligence-based approach to gathering information via rigorous open-source monitoring and a global network of human sources.” Founded in 1996 by George Friedman, this Austin, Texas, company “publishes analysis via ... website and customized email updates.” It isn’t clear that much of what Stratfor does with its “intelligence” is particularly interesting or controversial, but the way that it gets its “intelligence” is both interesting and controversial, as is evident from the WikiLeaks revelations.

As the press release from Stratfor’s founder, shown in Figure 2, indicates, Stratfor’s expressed objection to the Anonymous/WikiLeaks exposé is that it was “illegal” and a “breach of privacy.” Let’s see if we have this right: Stratfor is claiming that there’s something wrong with illegal breaches of privacy or the dissemination of information that has been obtained without the information owner’s permission.

Ponder that for a while. It seems to me to be a clear case of pots and kettles, snakes and crabs, or brambles and pomegranates. Let’s try to put it into some sort of meaningful perspective.

While the mainstream press has extensively covered WikiLeaks for several years now, Stratfor has operated largely in the dark. Many of us had never heard of Stratfor before the Anonymous hack of December 2011, so I offer the following short review for the benefit of the uninitiated.

Stratfor’s avowed goal is to become “the world’s leading private intelligence organization.” This is expressly stated in one of CEO George Friedman’s leaked emails (5 September 2011, with the subject line “Labor Day Review of Where We Are”). This is also the email in which Friedman announced to Stratfor employees the StratCAP partnership with Shea

## URL PEARLS

**B**ruce Schneier refers to HBGary Federal as a “cyberweapons arms manufacturer.” (<http://gizmodo.com/5888440/wikileaks-reveals-private-cias-dirty-laundry-updating-live>). HBGary has been associated with a variety of software that would qualify as either, including FastDump and FDPro Windows memory-capturing utilities and the Windows rootkit project, Magenta (<http://cyberwarzone.com/cyberwarfare/hbgarys-rootkit-project-magenta?page=4>). The Gamma Group is associated with FinFisher, a general-purpose snoop tool that offers screen scraping, Skype session capture, keylogging, decryption, and rootkit capabilities (<http://bits.blogs.nytimes.com/2012/08/13/elusive-finspy-spyware-pops-up-in-10-countries>). Some interesting analysis of the FinFisher product can be found at <https://citizenlab.org/2012/07/from-bahrain-with-love-finfishers-spy-kit-exposed>.

Wikileaks refers to the 5 million or so Stratfor email messages that it released as “The Global Intelligence Files” ([wikileaks.org/gifiles/releases.html](http://wikileaks.org/gifiles/releases.html)). WikiLeaks has the entire Palantir/HBGary/Berico slide presentation in PDF format online at [http://wikileaks.org/IMG/pdf/WikiLeaks\\_Response\\_v6.pdf](http://wikileaks.org/IMG/pdf/WikiLeaks_Response_v6.pdf). Forbes.com has the complete statement from Palantir CEO Alex Carp online at [www.forbes.com/sites/andygreenberg/2011/02/11palantir-apologizes-for-wikileaks-attack-proposal-cuts-ties-with-hbgary](http://www.forbes.com/sites/andygreenberg/2011/02/11palantir-apologizes-for-wikileaks-attack-proposal-cuts-ties-with-hbgary).

The PayPal book-banning story has been well covered ([www.huffingtonpost.co.uk/bernard-oleary/paypal-banned-books-the-books-banned-by-paypa\\_b\\_1314953.html](http://www.huffingtonpost.co.uk/bernard-oleary/paypal-banned-books-the-books-banned-by-paypa_b_1314953.html)). In reaction to the outcry from anticensorship groups, PayPal has since lifted the ban ([www.abffe.org/news/86299/](http://www.abffe.org/news/86299/)).

Morentz, then managing director of Goldman Sachs, who invested several million dollars in Stratfor to create actionable intelligence useful to investors in exchange for a Stratfor board seat. Apparently this deal soured.

Stratfor uses global informants. According to some media reports, at least some of these informants are paid via Swiss bank accounts and prepaid debit cards.

Stratfor serves global corporations and agencies. A quick review of the “GB Master Client List” spreadsheet dated 3-15-07 is a who’s who of financial institutions, government contractors, technology companies, and Forbes 1,000 companies, including Coke, Wexford Capital, Perot Systems, Dow Chemical, and Northrup Grumman.

According to Friedman, Stratfor is not above innovative means to con-

Palantir

### Potential Proactive Tactics

- Feed the fuel between the feuding groups. Disinformation. Create messages around actions to sabotage or discredit the opposing organization. Submit fake documents and then call out the error.
- Create concern over the security of the infrastructure. Create exposure stories. If the process is believed to not be secure they are done.
- Cyber attacks against the infrastructure to get data on document submitters. This would kill the project. Since the servers are now in Sweden and France putting a team together to get access is more straightforward.
- Media campaign to push the radical and reckless nature of wikileaks activities. Sustained pressure. Does nothing for the fanatics, but creates concern and doubt amongst moderates.
- Search for leaks. Use social media to profile and identify risky behavior of employees.

**Figure 1.** A slide taken from Palantir’s presentation “The WikiLeaks Threat.” (The CEO of Palantir has since apologized for this.)

**OUT OF BAND**



**George Friedman on Email Theft and the Wikileaks Release**

—Visit [Stratfor.com/hacking-news](http://Stratfor.com/hacking-news) to watch this video message from George Friedman



**Transcript:**

I'm George Friedman, founder and CEO of Stratfor.

As most of you know, in December thieves hacked into Stratfor data systems and stole a large number of company emails, as well as private information of Stratfor subscribers and friends. Today Wikileaks is publishing the emails that were stolen in December. This is a deplorable, unfortunate -- and illegal -- breach of privacy.

Some of the emails may be forged or altered to include inaccuracies. Some may be authentic. We will not validate either, nor will we explain the thinking that went into them. Having had our property stolen, we will not be victimized twice by submitting to questions about them.

trol its sources: "If this is a source you suspect may have value, you have to take control of [sic] him. Control means financial, sexual or psychological control to the point where he would reveal his sourcing and be tasked." This email is dated 6 December 2011 and went to a Stratfor intelligence analyst regarding an informant's report on the health of Hugo Chavez.

Regarding relationships with the media, Stratfor works with media organizations and journalists whom it refers to as (among other things) "confederation partners." It's not at all obvious that a private intelligence organization's close relation with the media satisfies the standards of journalistic ethics taught in the academy.

With those few clarifications in mind, I offer for your consideration Table 1 as a modest comparison of Stratfor and WikiLeaks in terms of their operations and objectives.

I've based Table 1 on information available from mainstream media reports and analysis of the WikiLeaks documents. Assuming that this is a fair characterization, and based on what you know about WikiLeaks and

**Figure 2.** Stratfor CEO's announcement of the WikiLeaks revelations.

**Table 1. Comparison of WikiLeaks and Stratfor operations.**

Activity	WikiLeaks	Stratfor
Revenue model	Not for profit	For profit
Primary constituency served	Media/individuals	Corporations/agencies
Seeks access to nonpublic, proprietary, or classified information, for which the owner does not authorize access	Under dispute	Yes
Relies on a leak-centric communication network	Yes	Yes
System built on paid informants	No	Yes
Uses active intelligence systems: leakers, spies, whistleblowers	Yes	Yes
Willing to corrupt media resources	Perhaps	Yes
Partners with media to inform public	Yes	No
Provides intelligence to media/public	Yes	Limited
Provides actionable intelligence to partners in military industrial complex	No	Yes
Black ops	No	Yes
Uses third-party contractors (spies)	No	Yes
Controls sources via money, sex, blackmail, extortion	No	Yes
Nature of risks to society	Overt	Covert

Stratfor, which group seems to you to be the greater threat to society?

### THE BRIGHT SIDE

Good journalists are always concerned about the possibility of accidentally disseminating erroneous information. At this point, I haven't seen a single report from any source that I deem credible that claims the WikiLeaks Stratfor emails are bogus. I encourage everyone to look into these leaked documents, and the concomitant media coverage, and come to their own conclusion.

The Stratfor revelations are alarming for at least two reasons. First, I'm not convinced that Stratfor's approach to intelligence analytics will lead to significantly better decision making than we've come to expect from the military industrial complex, and I'm fearful that unenlightened leadership may be lulled into overreliance on such analyses. That might in turn lead to even more ill-advised decisions. Second, I'm bothered by the

lack of oversight and transparency in the process. From the email, it appears that Stratfor has introduced a corrupting influence on the process of intelligence gathering.

The question that informed world citizens should ask is whether they feel comfortable with their governments supporting such things. It should be emphasized that there is a reason why governments and businesses outsource this kind of work. Is it due to the fact that dedicated private companies are so much better at it? Or do the customers and clients want to maintain distance from, and deniability of, putatively illegal activity.

There is no obvious Fourth Amendment protection against private shadow intelligence agencies, just as there is no First Amendment protection against PayPal banning books.

While the constitutional lawyers argue the legality, the public should be discussing whether or to what extent Stratfor's activities are consistent with democratic values and the

rule of law, and whether government agencies should be tolerating it, much less encouraging it. I'm not sure that a "trust us" defense should be any more compelling to society in this case than when it was used to defend flawless efficient markets before the most recent economic meltdown.

**O**ne final observation: it's unlikely that any of this would have become public were it not for Anonymous. But that's a topic for another column. **■**

*Hal Berghel, Out of Band column editor, is a professor of computer science at the University of Nevada, Las Vegas, where he is the director of the Identity Theft and Financial Fraud Research and Operations Center ([itffroc.org](http://itffroc.org)). Contact him at [hlb@computer.org](mailto:hlb@computer.org).*

**cn** Selected CS articles and columns are available for free at <http://ComputingNow.computer.org>.



## NEW TRANSACTIONS NEWSLETTER!

Stay connected with the IEEE Computer Society Transactions by signing up for our new Transactions Connection newsletter. It is free and contains valuable information like:

- News about your favorite transactions,
- Contributions from the Editorial Board,
- Information about related conferences,
- Multimedia,
- And much more.

Not a subscriber? Don't worry. You can still sign up to receive news about the transactions.

Visit <http://www.computer.org/newsletters> to sign up today!





## Focus on Your Job Search

**IEEE Computer Society Jobs** helps you easily find a new job in IT, software development, computer engineering, research, programming, architecture, cloud computing, consulting, databases, and many other computer-related areas.

**New feature:** Find jobs recommending or requiring the IEEE CS CSDA or CSDP certifications!

Visit [www.computer.org/jobs](http://www.computer.org/jobs) to search technical job openings, plus internships, from employers worldwide.

<http://www.computer.org/jobs>

IEEE  computer society | **JOBS**



The IEEE Computer Society is a partner in the AIP Career Network, a collection of online job sites for scientists, engineers, and computing professionals. Other partners include Physics Today, the American Association of Physicists in Medicine (AAPM), American Association of Physics Teachers (AAPT), American Physical Society (APS), AVS Science and Technology, and the Society of Physics Students (SPS) and Sigma Pi Sigma.



## IDENTITY SCIENCES

# Biometric Authentication: System Security and User Privacy

**Anil K. Jain**

Michigan State University

**Karthik Nandakumar**

Institute for Infocomm Research, Singapore



**While biometric systems aren't foolproof, the research community has made significant strides to identify vulnerabilities and develop measures to counter them.**

**I**dentify theft is a growing concern in our digital society. The US Federal Trade Commission reports that ID theft affects millions of innocent victims each year and is the most common consumer complaint ([www.ftc.gov/opa/reporter/idtheft/index.shtml](http://www.ftc.gov/opa/reporter/idtheft/index.shtml)).

Traditional authentication methods such as passwords and identity documents aren't sufficient to combat ID theft or ensure security. Such surrogate representations of identity can be easily forgotten, lost, guessed, stolen, or shared.

Biometric systems recognize individuals based on their anatomical traits (fingerprint, face, palmprint, iris, voice) or behavioral traits (signature, gait). Because such traits are physically linked to the user, biometric recognition is a natural and more reliable mechanism for ensuring that only legitimate or authorized users are able to enter a facility, access a computer system, or cross international borders. Biometric systems also offer unique advantages such as deterrence against repudiation and the ability to detect whether

an individual has multiple identity cards (for example, passports) under different names. Thus, biometric systems impart higher levels of security when appropriately integrated into applications requiring user authentication.

While law enforcement agencies have used fingerprint-based biometric authentication for more than a century in forensic investigations, the last two decades have seen a rapid proliferation of biometric recognition systems in a wide variety of government and commercial applications around the world. Figure 1 shows some examples.

Although many of these deployments are extremely successful, there are lingering concerns about the security of biometric systems and potential breaches of privacy resulting from the unauthorized release of users' stored biometric data. Like any other user authentication mechanism, a biometric system can be circumvented by a skillful impostor given the right circumstances and plenty of time and resources. Mitigating such concerns is essential to gaining public

confidence and acceptance of biometric technology.

## BIOMETRIC SYSTEM OPERATION

A biometric system first records a sample of a user's biometric trait using an appropriate sensor—for example, a camera for the face—during *enrollment*. It then extracts salient characteristics, such as fingerprint minutiae, from the biometric sample using a software algorithm called a *feature extractor*. The system stores these extracted features as a *template* in a database along with other identifiers such as a name or an identification number.

To be authenticated, the user presents another biometric sample to the sensor. Features extracted from this sample constitute the *query*, which the system then compares to the template of the claimed identity via a biometric *matcher*. The matcher returns a match score representing the degree of similarity between the template and the query. The system accepts the identity claim only if the match score is above a predefined threshold.

## IDENTITY SCIENCES

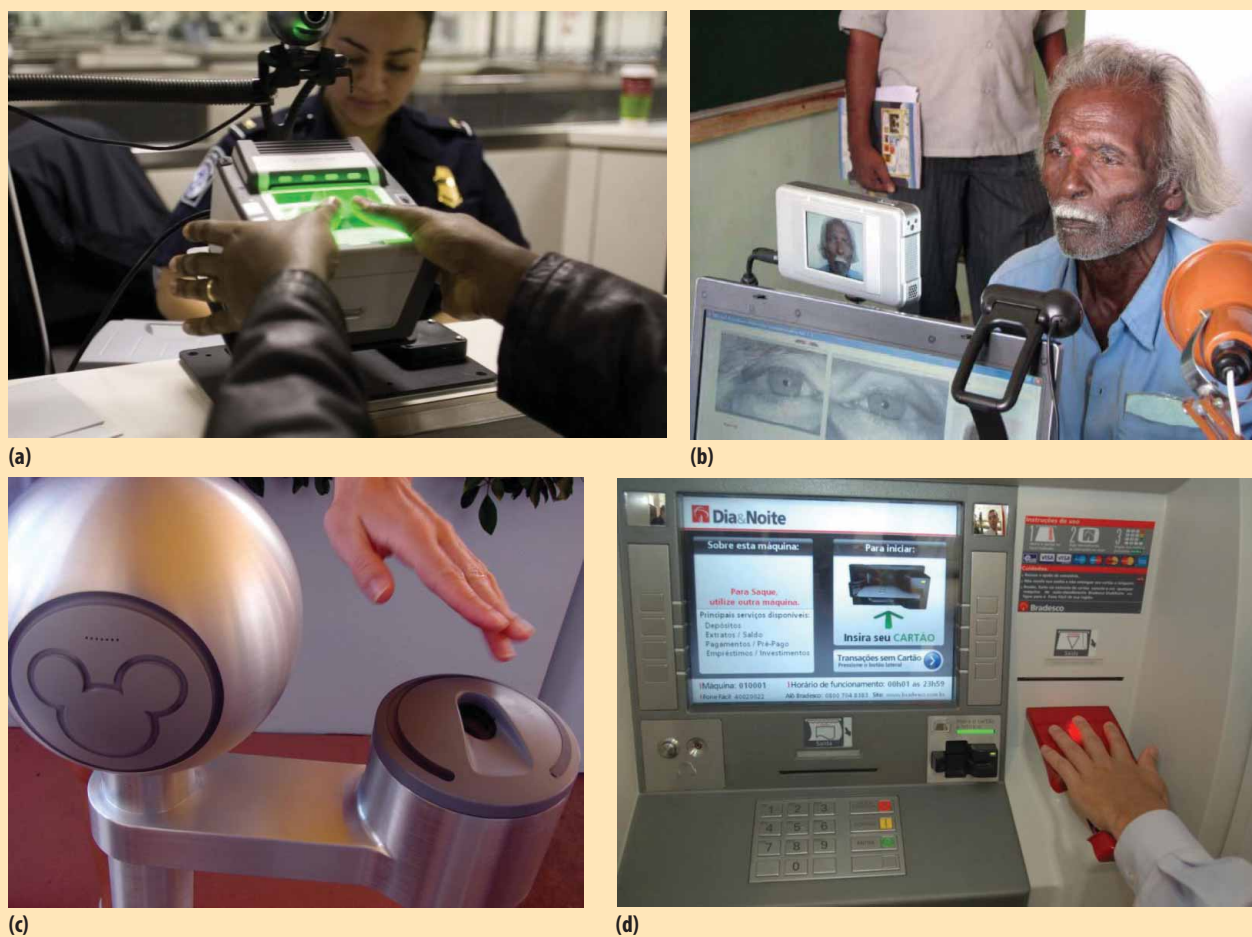

Figure 1. Examples of biometric authentication systems deployed in government and commercial applications. (a) The US-VISIT program to regulate international border crossings ([www.dhs.gov/files/programs/usv.shtm](http://www.dhs.gov/files/programs/usv.shtm)) records all 10 fingerprints of a visa applicant. (b) India's Aadhaar civil registry system ([www.uidai.gov.in](http://www.uidai.gov.in)) captures the iris and face images in addition to 10 fingerprints. (c) Walt Disney World Resort in Orlando, Florida, uses a fingerprint-based access system to prevent ticket fraud ([www.boston.com/news/nation/articles/2006/09/03/disney\\_world\\_scans\\_fingerprint\\_details\\_of\\_park\\_visitors](http://www.boston.com/news/nation/articles/2006/09/03/disney_world_scans_fingerprint_details_of_park_visitors)). (Photo by Mark Goldhaber; [www.mouseplanet.com/9797/Walt\\_Disney\\_World\\_Resort\\_Update#rfid](http://www.mouseplanet.com/9797/Walt_Disney_World_Resort_Update#rfid).) (d) Many banks in countries including Japan ([www.theregister.co.uk/2012/04/12/ogaki\\_palm\\_scanning\\_cash](http://www.theregister.co.uk/2012/04/12/ogaki_palm_scanning_cash)) and Brazil ([www.bradesco.com.br/site/conteudo/interna/default.aspx?secaold=680&idiomald=2](http://www.bradesco.com.br/site/conteudo/interna/default.aspx?secaold=680&idiomald=2)) use palm-vein-based automated teller machines. (Photo courtesy of Bradesco; [http://infosurhoy.com/cocoon/saii/xhtml/en\\_GB/features/saii/features/economy/2010/03/01/feature-04](http://infosurhoy.com/cocoon/saii/xhtml/en_GB/features/saii/features/economy/2010/03/01/feature-04).)

## BIOMETRIC SYSTEM VULNERABILITIES

A biometric system is vulnerable to two types of failures, as Figure 2 shows. A *denial of service* occurs when the system doesn't recognize a legitimate user, while an *intrusion* refers to the scenario in which the system incorrectly identifies an impostor as an authorized user. While there are many possible reasons for these failures, they can be broadly categorized as *intrinsic limitations* and *adversary*

*attacks* (A.K. Jain, A.A. Ross and K. Nandakumar, "Security of Biometric Systems," *Introduction to Biometrics*, Springer, 2011, pp. 259-306).

### Intrinsic limitations

Unlike a password-based authentication system, which requires a perfect match between two alphanumeric strings, a biometric-based authentication system relies on the similarity between two biometric samples.

Because an individual's biometric samples acquired during enrollment and authentication are seldom identical, as Figure 3 shows, a biometric system can make two types of authentication errors. A *false nonmatch* occurs when two samples from the same individual have low similarity and the system can't correctly match them. A *false match* occurs when two samples from different individuals have high similarity and the system incorrectly declares them as a match.

A false nonmatch leads to a denial of service to a legitimate user, while a false match can result in intrusion by an impostor. Because the impostor need not exert any special effort to fool the system, such an intrusion is known as a *zero-effort attack*. Most of the research effort in the biometrics community over the past five decades has focused on improving authentication accuracy—that is, on minimizing false nonmatches and false matches.

### Adversary attacks

A biometric system may also fail to operate as intended due to manipulation by adversaries. Such manipulations can be carried out via insiders, such as system administrators, or by directly attacking the system infrastructure. An adversary can circumvent a biometric system by coercing or colluding with insiders, exploiting their negligence (for example, failure to properly log out of a system after completing a transaction), or fraudulently manipulating the procedures of enrollment and exception processing, originally designed to help authorized users.

External adversaries can also cause a biometric system to fail through direct attacks on the user interface (sensor), the feature extractor and matcher modules, the interconnections between the modules, and the template database.

Examples of attacks targeting the system modules and their interconnections include Trojan horse, man-in-the-middle, and replay attacks. As most of these attacks are also applicable to password-based authentication systems, several countermeasures like cryptography, time stamps, and mutual authentication are available to prevent them or minimize their impact.

Two major vulnerabilities that specifically deserve attention in the context of biometric authentication

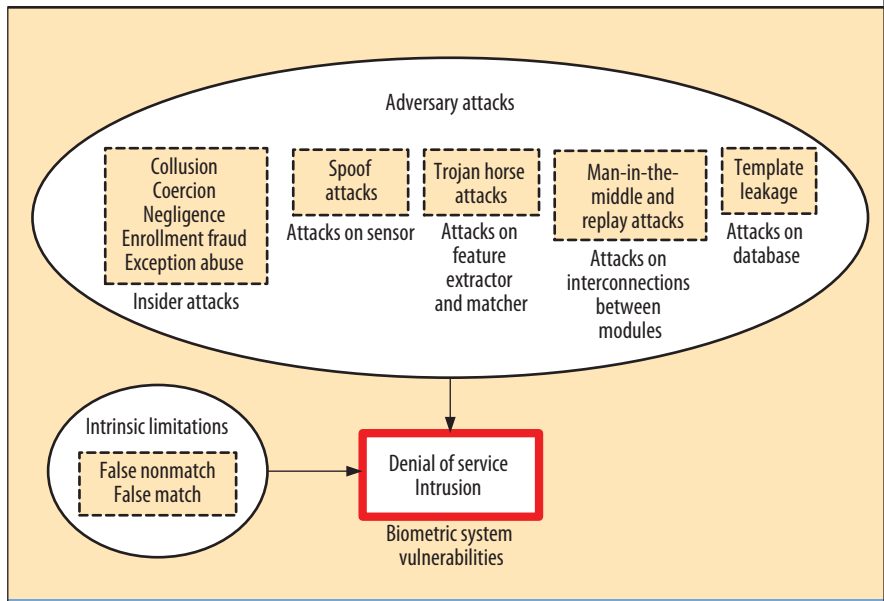
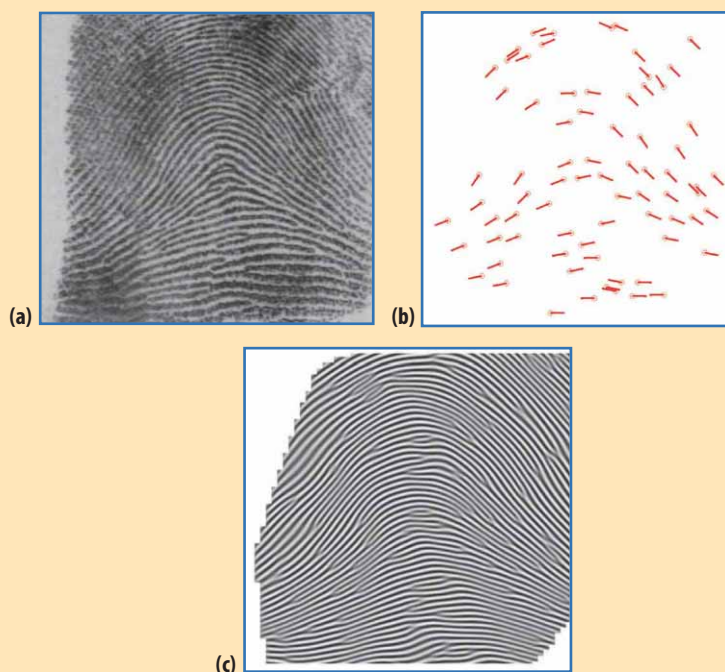

Figure 2. A biometric system is vulnerable to denials of service and intrusions, which can be caused by both intrinsic limitations and adversary attacks.



Figure 3. Inherent variability between biometric samples of the same individual. (a) Variations in fingerprint patterns of the same finger due to differences in finger placement on the sensor. (b) Variations in face images of the same person due to changes in pose. (c) Variations in iris images of the same eye due to differences in pupil dilation and gaze direction.

## IDENTITY SCIENCES



**Figure 4.** Example of obtaining a biometric trait by reverse engineering the corresponding biometric template: (a) original fingerprint image, (b) minutiae template information extracted from the fingerprint image, and (c) fingerprint image reconstructed using only the minutiae information. (Adapted from J. Feng and A.K. Jain, "Fingerprint Reconstruction: From Minutiae to Phase," *IEEE Trans. Pattern Analysis and Machine Intelligence*, Feb. 2011, pp. 209-223.)

are *spoof attacks* at the user interface and *template database leakage*. These two attacks have serious adverse effects on biometric system security.

A spoof attack involves presenting a counterfeit biometric trait not obtained from a live person. Examples of spoofed biometric traits include a gummy finger, photograph or mask of a face, or dismembered finger from a legitimate user.

A fundamental tenet of biometric authentication is that even though biometric traits aren't secrets—it may not be very difficult to covertly obtain a photo of a person's face or the fingerprint pattern from an object or surface touched by a person—the system is still secure because the trait is physically linked to a live user. A spoof attack, if successful, violates this basic assumption and thereby greatly undermines the system's security.

Researchers have developed numerous liveness detection techniques—for example, verifying the physiological properties of human fingers or observing involuntary human actions such as blinking of the eye—to ensure that the biometric trait captured by a sensor indeed comes from a live person (K.A. Nixon, V. Aimale, and R.K. Rowe, "Spoof Detection Schemes," *Handbook of Biometrics*, A.K. Jain, P. Flynn, and A.A. Ross, eds., Springer, 2007, pp. 403-424).

Template database leakage refers to a scenario where a legitimate user's biometric template information becomes available to an adversary. This aggravates the problem of spoofing because it makes it easier for the adversary to recover the biometric pattern by simply reverse engineering the template, as Figure 4 shows. Moreover, unlike passwords

and ID cards, it isn't possible to replace stolen templates with new ones because biometric traits are irrevocable. Finally, the stolen biometric templates can be used for unintended purposes—for example, to covertly track a person across multiple systems or obtain private health information.

### BIOMETRIC TEMPLATE SECURITY

A critical step in minimizing the security and privacy risks associated with biometric systems is to protect the biometric templates stored in the system database. While the risks can be mitigated to some extent by storing the templates in a decentralized fashion—for example, in a smart card carried by the user—such solutions aren't feasible in applications requiring deduplication capability such as the US-VISIT or India's Aadhaar system.

Although many techniques exist for securing passwords including encryption/hashing and key generation, they're predicated on the assumption that passwords provided by the user during enrollment and authentication are identical.

### Template security requirements

The main challenge in developing a biometric template protection scheme is to achieve an acceptable tradeoff among three requirements.

**Noninvertibility.** It must be computationally hard to recover the biometric features from the stored template. This prevents the adversary from replaying the biometric features gleaned from the template or creating physical spoofs of the biometric trait.

**Discriminability.** The template protection scheme shouldn't degrade the biometric system's authentication accuracy.

**Revocability.** It should be possible to create multiple secure templates from the same biometric data that aren't linkable to that data. This

property not only enables the biometric system to revoke and reissue new biometric templates if the database is compromised, but it also prevents cross-matching across databases, thereby preserving the user's privacy.

### Template security approaches

There are two generic approaches for securing biometric templates: *biometric feature transformation* and *biometric cryptosystems*.

In the case of biometric feature transformation, as Figure 5a shows, the secure template is derived by applying a noninvertible or one-way transformation function to the original template; this transformation is typically based on user-specific parameters. During authentication, the system applies the same transformation function to the query and matching occurs in the transformed domain.

Biometric cryptosystems, as Figure 5b shows, store only a fraction of the information derived from the biometric template known as the *secure sketch*. While the secure sketch in itself is insufficient to reconstruct the original template, it does contain sufficient data to recover the template in the presence of another biometric sample that closely matches the enrollment sample.

The secure sketch is typically obtained by binding the biometric template with a cryptographic key. However, a secure sketch isn't the same as a biometric template encrypted using standard cryptographic techniques.

In standard encryption, the encrypted template and decryption key are two separate entities and the template is secure only as long as the decryption key is secure. A secure sketch encapsulates both the biometric template and the cryptographic key as a single entity. Neither the key nor the template can be recovered using only the secure sketch. When the system is presented

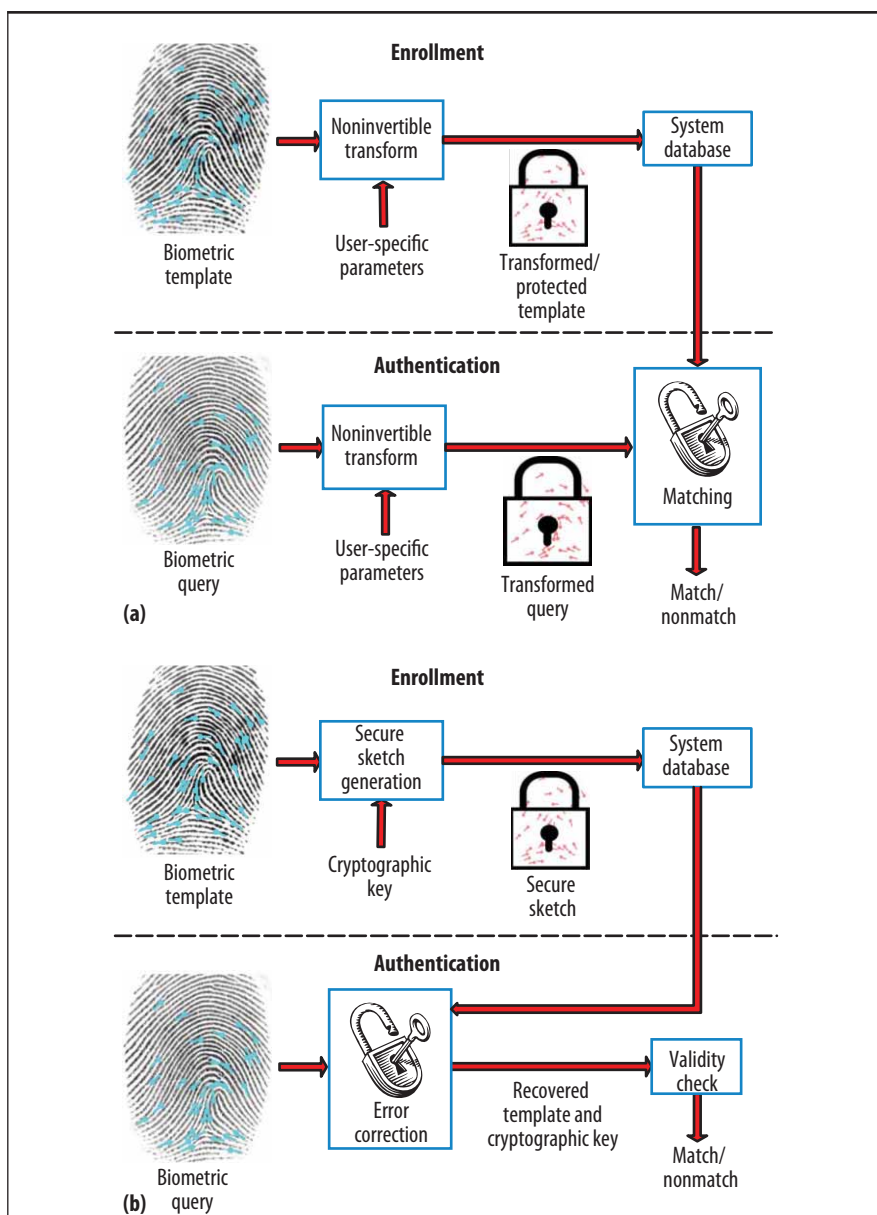

**Figure 5. Securing biometric templates using (a) biometric feature transformation and (b) biometric cryptosystems.**

with a biometric query that closely matches the template, it can recover both the original template and the cryptographic key using common error detection techniques.

Researchers have proposed two main approaches for generating a secure sketch: *fuzzy commitment* and *fuzzy vault*. Fuzzy commitment can be used to protect biometric templates that are represented as fixed-length binary strings

(A. Juels and M. Wattenberg, "A Fuzzy Commitment Scheme," *Proc. 6th ACM Conf. Computer and Comm. Security [CCS 99]*, ACM, 1999, pp. 28-36). The fuzzy vault is useful for protecting templates that are represented as a set of points (K. Nandakumar, A.K. Jain, and S. Pankanti, "Fingerprint-Based Fuzzy Vault: Implementation & Performance," *IEEE Trans. Information Forensics and Security*, Dec. 2007, pp. 744-757).

## IDENTITY SCIENCES

### Pros and cons

Biometric feature transformation and biometric cryptosystems have their own pros and cons.

Matching is often straightforward in a feature transformation scheme, and it may even be possible to design transformation functions that don't alter the original feature space's characteristics. However, finding an appropriate transformation function that is noninvertible but at the same time tolerant to inherent intra-user biometric variations can be difficult.

While secure sketch generation techniques based on sound information-theoretic principles are available for biometric cryptosystems, the challenge is to represent the biometric features in standardized data formats like binary strings and point sets. Therefore, an active research topic is designing algorithms that convert the original biometric template into standardized data formats like fixed-length binary strings or point sets without any loss of discriminative information (A. Nagar, K. Nandakumar, and A.K. Jain, "Multibiometric Cryptosystems Based on Feature-Level Fusion," *IEEE Trans. Information Forensics and Security*, Feb. 2012, pp. 255-268).

Fuzzy commitment and fuzzy vault have other limitations, including the inability to generate multiple nonlinkable templates from the same biometric data. One possible way to overcome this problem is to apply

a feature transformation function to the biometric template before it is protected using a biometric cryptosystem. Such systems, which combine feature transformation with secure sketch generation, are known as *hybrid biometric cryptosystems*.

### THE PRIVACY CONUNDRUM

The irrefutable link between users and their biometric traits has triggered valid concerns about user privacy. In particular, knowledge of the biometric template information stored in the database can be exploited to compromise user privacy in many ways.

Template protection schemes can mitigate this threat to some extent, but many thorny privacy issues remain beyond the scope of biometric technology:

- Who owns the biometric data, the individual or the service providers?
- Will the use of biometrics be proportional to the need for security in a given application? For example, should a fingerprint be required to purchase a hamburger at a fast food restaurant or access a commercial website?
- What is the optimal tradeoff between application security and user privacy? For example, should governments, businesses, and other entities be able to use surveillance cameras at public spaces to covertly track benign activities of users?

There are currently no satisfactory practical solutions on the horizon to address such questions.

**B**iometric recognition provides more reliable user authentication than passwords and identity documents, and is the only way to detect duplicate identities. While biometric systems aren't foolproof, the research community has made significant strides to identify vulnerabilities and develop measures to counter them. New algorithms for protecting biometric template data alleviate some of the concerns about system security and user privacy, but additional improvements will be required before such techniques find their way into real-world systems. **C**

*Anil K. Jain is a University Distinguished Professor in the Department of Computer Science and Engineering at Michigan State University. Contact him at [jain@cse.msu.edu](mailto:jain@cse.msu.edu).*

*Karthik Nandakumar is a research scientist in the Institute for Infocomm Research, Singapore. Contact him at [knandakumar@i2r.a-star.edu.sg](mailto:knandakumar@i2r.a-star.edu.sg).*

**Editor: Karl Ricanek Jr., director of the Face Aging Group at the University of North Carolina Wilmington; [ricanekk@uncw.edu](mailto:ricanekk@uncw.edu)**

**cn** Selected CS articles and columns are available for free at <http://ComputingNow.computer.org>.

# computing

in SCIENCE & ENGINEERING

Subscribe today for the latest in computational science and engineering research, news and analysis, CSE in education, and emerging technologies in the hard sciences.

AIP

[www.computer.org/cise](http://www.computer.org/cise)

IEEE  computer society

## SOCIAL COMPUTING

# Customer Service 2.0: Where Social Computing Meets Customer Relations

Frank Bi and Joseph A. Konstan  
University of Minnesota



Social computing is moving customer relations from private spaces into the public space.

Before the Internet, there was the suggestion box. Impersonal but effective, the box served as the bearer of bad (and sometimes good) news for businesses from frank customers who felt the need to share their opinions. Some companies took the suggestions to heart, while others ignored them if they bothered to read them at all. If customers didn't use the box, the business never found out what was on their mind.

Today, customers use the Internet, especially social media, to complain to or about—as well as praise—businesses. Consequently, companies are slowly but surely expanding their presence on social media sites. According to a recent survey by CompTIA, an IT industry association, 82 percent of responding companies had a Facebook page, 68 percent had a Twitter profile, and 68 percent had a LinkedIn page (*Social Business: Trends and Opportunities*, 2012).

As the CompTIA study reveals, proper use of social media tools can lead to better communication

with customers, cost savings, brand positioning, and other benefits. However, many businesses aren't having success using such tools.

To get a first-hand look at this issue, we went into the field and spoke with numerous business owners, managers, and customers. We also talked with Christopher Lower, a 30-year marketing veteran who teaches companies how to respond to comments and reviews online. Lower is the founder of Sterling Cross Communications, which has specialized in social media marketing and online reputation management for the past decade. He explained that an online reputation—established through social media or elsewhere—can make or break a business.

Even before the emergence of social media, aggravated customers found ways to complain publicly online. Lower cited examples of websites dating back to 1996 created with a company's name followed by "sucks" in the domain name. And an online reputation spreads quickly—so quickly and widely that it can cause a sudden stock price drop.

In other words, companies can't dismiss negative comments as they did in the days of the physical suggestion box. "Ignore it and it will go away" doesn't work anywhere, especially on social media," said Lower. He cautions businesses that waiting 24 hours to respond to a negative review is too long, especially when a Web search can bring the review back up. "Whether or not the situation was right or wrong, perception wins," said Lower. "The person had a bad experience with your brand, and if you can't at least listen to them and acknowledge them, that change in perception is going to stay."

Of course, customers also use the same social media to share positive experiences they've had with a company or product.

## A BAR CUSTOMERS "LIKE"

Republic, a craft beer bar near downtown Minneapolis, doesn't have an advertising budget. Situated in an area dense with similar establishments that have been around longer than the year-and-a-half-old bar, Republic has nevertheless

## SOCIAL COMPUTING

quickly earned a solid reputation for itself around the neighborhood and is soon opening a second location.

With more than 1,250 likes on its Facebook page, social media has without a doubt been instrumental in the bar's success, according to manager Ryan O'Leary. "We believe the product should sell itself," he said. And it has.

A brief glance at the bar's Facebook and Twitter profiles show daily posts about Republic and images of its offerings. Loyal customers follow the Twitter feed almost religiously, boasted O'Leary, who added that some customers show up almost immediately following a post about a certain product, such as a prized brew about to be made available. Most of Republic's Twitter interactions are with beer enthusiasts who inquire about select beers or make suggestions about what they'd like to see, said O'Leary.

Before the advent of social media, restaurants and bars limited their online presence to a website, observed O'Leary. However, Republic leads customers to its Facebook page, where the user interface is more inviting and is familiar to most people. "It's the most unique marketing technique I've ever seen," said O'Leary, who has worked in the restaurant service industry for more than 10 years. On social media, "you speak to your customers more, and you speak to them directly."

Republic relies on social media in other ways. The bar's owners and an off-site employee charged with managing social media marketing strategies and maintaining the bar's online reputation receive Twitter and Facebook update notifications on their cell phones, enabling them to keep abreast of consumer opinions and suggestions in real time.

### HAVING AN IN AT THE INN

Vijay Patel has operated Millwood Inn and Suites, a small family-owned hotel outside San Francisco, for the

past 40 years. But it was only in the past few years that Patel started reading and responding to online reviews.

"We're trying to get in touch with people on a more personal level," said Patel. "It's a learning experience for us, and we try to evaluate what to do to do it better." Along with monitoring comments on TripAdvisor, one of the world's largest travel-related user communities, Patel has experimented with Facebook by adding former customers as friends, although he has since scaled that effort back because the results didn't justify the time invested.

### The suggestion box hasn't gone away—it has just changed.

On TripAdvisor, the hotel has received more than 230 reviews and is ranked as the number one hotel in Millbrae, California. While there are more than 110 "excellent" reviews, there are also two "terrible" reviews. One traveler even called his time there the "worst hotel stay ever experienced." Patel responded in 200 words, explaining the situation to potential guests and encouraging them to read the hundreds of other positive reviews.

"I personally don't like it when somebody for some reason had a bad day and they take it out on the Internet," said Patel. "It's easy to slander a business online."

Customers can and have tried to hold a company's online reputation hostage, explained Sterling Cross Communications' Lower, but a business can combat this by responding respectfully and issuing an apology or otherwise making amends.

### THE CUSTOMER'S LAST RECOURSE

What happens when customers can't get effective support? In some cases, they take their case straight to

Facebook, Twitter, and other social media.

Anna Gallegos of Houston waited several hours for a customer support representative to install her cable TV and Internet service. When no one showed up during the appointment window, she tried to arrange installation through email. After a dozen futile attempts, the exasperated Gallegos posted a complaint on the company's Facebook page.

Gallegos found she wasn't alone. "People were complaining about everything," she said. By the next business day, the company had posted a "copy-paste" response to

all of its customers with a generic apology and another email address to contact. Gallegos got her appointment rescheduled a week after the original date, but her perceptions of the company took a dive; she's prepared for a fight the next time she has to deal with bad service.

One of the authors had a similar experience dealing with a troublesome Android app, but with a happier resolution.

After five frustrating email exchanges with the app company's customer service representatives, he felt like he was going in circles. He posted a blog message on Google+, and almost as an afterthought tweeted a pointer to this post with the company's customer support hashtag.

Within an hour, the company sent him a private message and put him in contact with someone who took ownership of the case. In the end, he got more than he'd originally asked for, and all within a few hours of the tweet. His response moved from anger and frustration to surprise and delight—so delighted that he posted a follow-up blog message applauding the service.



**S**ocial computing is moving customer relations from private spaces into the public space. And it's extending the reach of that public space through sites with tens of millions of visitors and search engine indexing.

The good news is that a few clicks can alert thousands or millions of potential customers about your new tap beer or bed-and-breakfast special. The bad news is that customers can just as easily vent their frustrations with your service to the same number of people. Life in a fishbowl is hard.

And the fishbowl is imposing new rules. Responding authentically to a complaint—whether by apology or by supplying explanatory context and details—can be good. Keeping loyal customers up-to-date through social media can also be good. But overloading your customers with too many posts and boilerplate language can be bad. And losing your temper online and telling off a customer—even a rude one—can be very bad.

The suggestion box hasn't gone away—it has just changed. The box is there for all to see, and everyone is watching how you handle it. 

*Frank Bi is a computer science and journalism student at the University of Minnesota. Contact him at [frank@frankbi.com](mailto:frank@frankbi.com).*

*Joseph A. Konstan is the Distinguished McKnight Professor of Computer Science and Engineering at the University of Minnesota. Contact him at [konstan@umn.edu](mailto:konstan@umn.edu).*

**Editor: John Riedl, Department of Computer Science and Engineering, University of Minnesota; [riedl@cs.umn.edu](mailto:riedl@cs.umn.edu)**

 Selected CS articles and columns are available for free at <http://ComputingNow.computer.org>.

# IEEE ISM 2012

14th IEEE International Symposium on  
Multimedia

## 10-12 December 2012

Irvine, CA, USA

ISM 2012 is an international forum for researchers to exchange information regarding advances in the state of the art and practice of multimedia computing, as well as to identify the emerging research topics and define the future of multimedia computing.

*Register today!*

<http://ism.eecs.uci.edu>



## COMPUTER SOCIETY CONNECTION

# CS Names 2012 Tech Award Recipients



**T**he IEEE Computer Society announced the 2012 recipients of three technical achievement awards. This year's Seymour Cray Award went to Peter Kogge for innovations in advanced computer architecture and systems. Klaus Schulten and Laxmikant "Sanjay" Kale shared the Sidney Fernbach Award for outstanding contributions in the application of high-performance computers.

## PETER KOGGE RECEIVES SEYMOUR CRAY COMPUTER ENGINEERING AWARD



**Peter Kogge, recipient of the 2012 Seymour Cray Award, has been at the forefront of**

**several innovations that have shaped the computing industry over the past three decades.**

Currently the Ted H. McCourtney Professor of Computer Science and Engineering at the University of Notre Dame and an IEEE Fellow, Peter Kogge has been at the forefront of several innovations that have shaped the computing industry over the past three decades. While working on his PhD at Stanford University

in the 1970s, he invented the Kogge-Stone-Adder process, which is still considered the fastest way of adding numbers on a computer.

During his 26-year career at IBM, Kogge designed the Space Shuttle I/O processor, one of the first multi-threaded computers and the first to fly in space. Kogge also invented the world's first multicore processor, Execube, which his IBM team placed on a memory chip in an early effort to solve the data bottleneck problem.

More recently, Kogge led a team of computer professionals for the US Defense Advanced Research Projects Agency (DARPA) to pioneer development of a supercomputer capable of executing a quintillion mathematical operations per second.

Kogge's research interests include massively parallel processing architectures, advanced VLSI and nanotechnologies and their relationship to computing systems architectures, non-von Neumann models of programming and execution, and parallel algorithms and applications and their impact on computer architecture.

One of the IEEE Computer Society's highest awards, the Seymour Cray Award recognizes innovative contributions to high-performance computing systems that

best exemplify Cray's creative spirit. The award includes a US\$10,000 honorarium.

Kogge is scheduled to accept the award at the keynote session at SC12 in Salt Lake City on 13 November.

## SIDNEY FERNBACH AWARD RECIPIENTS: KLAUS SCHULTEN AND SANJAY KALE



**Klaus Schulten (left) and Sanjay Kale (right) received the 2012 Sidney Fernbach Award for their development of widely used parallel software for large biomolecular systems simulation.**

Klaus Schulten and Sanjay Kale, professors at the University of Illinois at Urbana-Champaign, received the 2012 IEEE Computer Society Sidney Fernbach Award for their development of widely used parallel software for large biomolecular systems simulation.

Schulten, a Swanlund Professor of Physics, directs the Center for Biomolecular Modeling at the Beckman Institute and codirects the Center for the Physics of Living Cells.

His research focuses on molecular assembly and cooperation in biological cells, and he was the first to demonstrate that parallel computers can be practically employed to solve the classical many-body problem in biomolecular modeling. Thousands of researchers worldwide use his group's visual molecular dynamics (VMD) program for displaying, animating, and analyzing large biomolecular systems and NAMD (Not [just] Another Molecular Dynamics) program for modeling them on personal computers as well as at the world's leading supercomputing centers. Schulten and his team are presently developing a new computational method that assists biologists in solving the structures

of the very large macromolecular complexes forming the machinery of living cells.

Corecipient Kale is a professor of computer science, director of the Parallel Programming Laboratory, and a senior investigator for the Blue Waters project at the National Center for Supercomputing Applications.

His parallel computing work focuses on enhancing performance and productivity via adaptive runtime systems, with research on programming abstractions, dynamic load balancing, fault tolerance, and power management. These efforts are embodied in Charm++, a widely distributed parallel programming system.

Kale, an IEEE Fellow, collaboratively developed the NAMD application as well as other applications for computational cosmology, quantum chemistry, rocket simulation, and unstructured meshes. He is a cowinner of the 2002 Gordon Bell Award. Kale and his team won the HPC Challenge Best Performance award at SC11 for their entry based on Charm++.

Established in 1992 in memory of high-performance computing pioneer Sidney Fernbach, the Fernbach Award recognizes outstanding contributions in the application of high-performance computers using innovative approaches. The award comes with a US\$2,000 honorarium.

Kale and Schulten are slated to receive the award at SC12. 

## New IEEE CS Membership Packages Serve Specific Technical Interests

**I**n an effort to better serve the growing audience of global computing professionals, the IEEE Computer Society is launching membership packages to meet specific technical focuses and goals.

New and renewing members will be able to choose a membership package in one of four focus areas—software and systems, information and communication technologies (ICT), security and privacy, or computer engineering—to provide targeted resources for keeping up to date in specific technical areas and meeting career-development goals.

“This is just another way the IEEE Computer Society is adding value and evolving to help serve

the global workforce of technology leaders,” said IEEE Computer Society President John Walz. “We hope these attractive bundles—featuring the Computer Society's best information sources, from webinars and articles to magazine subscriptions—will provide an easy and attractive means of keeping up with the rapidly changing technology world.”

Each package includes a monthly newsletter covering technology in the specific focus area, an electronic version of a CS magazine serving that interest area, 12 free CS articles of the member's choosing, three free CS webinars, and special discounts on CS training courses. These package benefits are in addition to standard

CS membership benefits, including a subscription to *Computer*, access to thousands of online courses and books, and discounts on conferences and other products.

Those who sign up for the software focus package will receive an electronic version of *IEEE Software*. ICT focus package subscribers will receive *IT Pro*, security and privacy focus package subscribers will receive *IEEE Security & Privacy*, and computer engineering focus package subscribers will receive *IEEE Micro*.

To select the focus package that meets your interests, visit the IEEE Computer Society Join page ([www.computer.org/portal/web/membership/join](http://www.computer.org/portal/web/membership/join)). 

## COMPUTER SOCIETY CONNECTION

## IEEE AND IEEE CS LAUNCH TRYCOMPUTING.ORG

IEEE and the IEEE Computer Society launched a new online computing education portal in September. [TryComputing.org](http://TryComputing.org) makes global computing education resources available for pre-university teachers, school counselors, parents, and students. The site, intended to build on the successes of its counterpart, [TryEngineering.org](http://TryEngineering.org), features information about academic and career preparation in computing.

[TryComputing.org](http://TryComputing.org) includes profiles of computing professionals and students, a computing career cloud tool, an accredited computing degree program search, and lesson plans. It provides information about the wide range of career options available in the evolving computing field. Visitors get a glimpse into the life and work of everyday computing professionals and undergraduate students, and meet computing heroes who have made significant contributions to the field through a series of engaging profiles. The computing career cloud tool suggests careers for visitors to explore further on the site according to their personal interests.

The portal supports academic preparation in computing through descriptions of popular computing majors and a searchable database of accredited computing degree programs worldwide. Additionally, it offers career preparation guidance by suggesting pre-university coursework and listing extracurricular involvement opportunities such as competitions and scholarships.

[TryComputing.org](http://TryComputing.org) includes a series of lesson plans to help pre-university educators introduce essential computing concepts to their students. The plans include all of the information necessary for a teacher to successfully implement these activities in the classroom, such as background information on each topic, step-by-step instructions, lists of necessary materials, student worksheets, and references to education standards. Teachers can also rate and review lesson plans featured on the site.

The computing education portal was developed through a partnership between the IEEE Computer Society and the IEEE Educational Activities Board with funding from the IEEE New Initiatives Committee.

# Systems Engineering Body of Knowledge Version 1.0 Is Available

The *Guide to the Systems Engineering Body of Knowledge* (SEBoK) is now available as a wiki document at [www.sebokwiki.org](http://www.sebokwiki.org).

The *SEBoK Guide* is the product of the Body of Knowledge and Curriculum to Advance Systems Engineering (BKCASE) project, which was organized in September 2009. Stevens Institute of Technology and the Naval Postgraduate School led the project in partnership with the International Council of Software Engineering, the IEEE Computer Society, the IEEE Systems Council, ACM, the National Defense Industrial

Association, and the US Department of Defense's Systems Engineering Research Center.

CS representatives on the project were Thomas B. Hilburn, professor emeritus of software engineering at Embry-Riddle Aeronautical University, and Dick Fairley, principal associate at Software & Systems Engineering Associates and chair of the IEEE Computer Society Professional Activities Board Software and Systems Engineering Committee.

The *SEBoK Guide* represents contributions from 70 authors around the world and comments

from hundreds of reviewers. Primary funding came from the US Department of Defense, with significant contributions in kind coming from the authors' home organizations.

In January 2011, the project opted for a wiki-based presentation to support the evolution of the document with technology and the maturing field of systems engineering. Systems engineers are invited to use SEBoK in their professional efforts and to comment on it in the wiki. BKCASE expects the *SEBoK Guide* to receive minor updates twice a year and major updates every third year. **■**

## CALL AND CALENDAR

CALLS FOR ARTICLES  
FOR COMPUTER

*Computer* seeks submissions for a June 2013 special issue on big data, exploring aspects of discovery, productivity, and policy, with a focus on their socioethical implications.

This special issue will address how deeply personal data, such as how often and with whom we communicate using our cell phones or other digital devices; our location; what products and services we buy; where we eat, sleep, and work every day; and our photos and videos will likely be scrutinized in the context of data-driven decision making. In a way, we will be trading our privacy for a new kind of “surveillance” based on the premise of customer care.

The guest editors seek varied perspectives regarding the challenges, possibilities, and benefits of big data. They particularly welcome articles that feature qualitative assessments, case studies from government agencies, perspectives from Internet search companies and other hardware and software vendors, predictive studies demonstrating paradigm shifts, and social impact research.

Articles should appeal to a broad interdisciplinary audience or policy professionals in the information and communications technology sector. The writing should be original, avoiding long discussions about theories, theorems, algorithms, or mathematical notations. All manuscripts are subject to peer review on both techni-

SUBMISSION  
INSTRUCTIONS

The Call and Calendar section lists conferences, symposia, and workshops that the IEEE Computer Society sponsors or cooperates in presenting.

Visit [www.computer.org/conferences](http://www.computer.org/conferences) for instructions on how to submit conference or call listings as well as a more complete listing of upcoming computing-related conferences.



cal merit and relevance to *Computer's* readership. Accepted papers will be professionally edited for content and style.

The guest editors for this special issue are Katina Michael ([katina@uow.edu.au](mailto:katina@uow.edu.au)), an associate professor on the Faculty of Informatics at the University of Wollongong, Australia, and Keith Miller ([miller.keith@uis.edu](mailto:miller.keith@uis.edu)), a professor in the Department of Computer Science at the University of Illinois Springfield.

Paper submissions are due by **15 January 2013**. Please email the guest editors a brief description of the article you plan to submit by 15 December 2012. Visit [www.computer.org/computer/cfp6](http://www.computer.org/computer/cfp6) to view the complete call for papers.

For author guidelines and information on how to submit a manuscript, visit [www.computer.org/portal/web/peerreviewmagazines/computer](http://www.computer.org/portal/web/peerreviewmagazines/computer).

*Computer* seeks submissions for an October 2013 special issue on multi-core memory coherence.

As we enter an era of large multi-core systems, the question of efficiently supporting a shared memory model has become more important. Massively parallel architectures lacking coherent shared memory have enjoyed great success in niche applications such as 3D rendering, but general programming developers still demand the convenience of a shared memory abstraction.

Efficiently using the Message Passing Interface requires that individual computation tasks must be relatively large to overcome communication latencies. It becomes difficult to use the MPI at the fine-grained level when fast on-chip communication is available. Higher-level mechanisms like MapReduce or shard-based databases are popular in particular application domains, though researchers have not yet efficiently applied them at the chip/node level.

This special issue will focus on approaches to providing scalable, shared on-chip memory, paramount in a future where individual nodes will have on the order of 1,000 cores each.

Suggested topics include but are not limited to private and shared cache hierarchies; scalable memory coherence protocols, directory-based and otherwise; data layout and placement techniques; on-chip interconnects to support shared-memory abstractions; and hardware, software, and hybrid approaches.

Articles are due by **1 March 2013**. Visit [www.computer.org/computer/cfp10](http://www.computer.org/computer/cfp10) to view the complete call for papers.

CALLS FOR ARTICLES  
FOR OTHER IEEE CS  
PUBLICATIONS

*IEEE Pervasive Computing* plans an October-December 2013 special issue on cloud computing.

## CALL AND CALENDAR

## EVENTS IN 2012 &amp; 2013

## December 2012

1-5	MICRO-45
3-6	CLOUDCOM 2012
5-7	RTSS 2012
6-8	APSCC 2012
10-12	ICIOS 2012
11-14	ICDM 2012
17-19	SOCA 2012
17-20	DASC 2012
19-21	HIPC 2012

## January 2013

15-18	WACV 2013
28-30	ICOIN 2013
28-31	ICNC 2013

## February 2013

23-27	HPCA 2013
-------	-----------

Arguably, two of the most important technological developments of the past few years are the emergence of mobile and cloud computing. By shifting the hardware and staffing costs of managing computational infrastructure to third parties such as Google, Microsoft, and Amazon, cloud computing has made it possible for small organizations and individuals to deploy world-scale services; all they need to pay is the marginal cost of actual resource usage. At the same time, the deployment of 3G and 4G networks, rapid adoption of feature-rich smartphones, and growing integration of computation into consumer products such as cars and home appliances have brought mobile and pervasive computing into the mainstream.

This special issue aims to explore the intersections of these two trends. Mobile and embedded devices make it possible for users to access cloud-based services and data anywhere and anytime, extending their reach into everyday life. Simultaneously, cloud computing offers a natural platform to remedy the lack of local resources in mobile and pervasive devices while

enabling resource-intensive next-generation applications.

Welcomed are original, high-quality submissions addressing all aspects of this field, as long as the connection to the focus topic is clear and emphasized.

Articles are due **1 December 2012**. Visit [www.computer.org/portal/web/computingnow/pccfp4](http://www.computer.org/portal/web/computingnow/pccfp4) to view the complete call for papers.

*IEEE Internet Computing* plans a September/October 2013 special issue on dynamic collective work.

As the Internet has changed the way in which data circulates, we have shifted from a world of paper documents to one of online documents, databases, and provenance systems. This has also increased the size and complexity of systems that support today's globally distributed, rapidly changing, and agile collaborative enterprises. Such systems are becoming increasingly federated and are generating a huge amount of data at different granularity levels that include tweets, blog posts, instant messages, Facebook updates, and other social media content. These systems and data are fueling explosive growth in dynamic collective work in the healthcare, insurance, banking, and other industries.

Dynamic and collective activities are characterized by their flexibility and people-driven nature. Automobile insurance claims handling, order processing of prescription drugs, hospital patient case management, and recovery and response assistance during natural disasters are just a few examples. In these and other tasks, various factors determine the set of actions that must be performed and the order in which they're executed, including human judgment and document contents.

This special issue seeks original articles describing research efforts and experiences concerning Internet-supported dynamic collective work.

Articles are due **4 January 2013**.

## MICRO-45

The 45th Annual International Symposium on Microarchitecture brings together researchers and industrial designers in the fields of microarchitecture, compilers, and systems. It will cover topics such as network-on-chip architectures, near-threshold computing, and security and privacy.

MICRO-45 takes place 1-5 December in Vancouver. Visit [www.microsymposia.org/micro45](http://www.microsymposia.org/micro45) for more information.

Visit [www.computer.org/portal/web/computingnow/iccfc5](http://www.computer.org/portal/web/computingnow/iccfc5) to view the complete call for papers.

*IEEE Micro* plans a July/August 2013 special issue on reliability.

Over the past decade, designers have sought better ways to balance power, performance, and cost. Of these, power has emerged as a first-order design challenge. In the coming era, this challenge may be subsumed by that of building robust and reliable systems. As technology advances, systems are becoming increasingly susceptible to transient errors such as timing violations, parameter variations, and aging. Without innovations in the areas of microprocessor and software reliability, future systems may face continuous failure. Thus, we need new computing paradigms that incorporate adaptive techniques at both the hardware and software layers to ensure resilient execution. The system, as a whole, must dynamically detect and recover from errors to meet historically established high reliability standards without exceeding power budgets and cost constraints or violating performance targets.

This issue seeks original articles on all topics related to reliability that span the layers in the system stack, from device, circuit, and architecture design to the role of software in enabling robust and reliable computing.

Articles are due **8 January 2013**. Visit <http://www.computer.org/portal/web/computingnow/micfp4> to view the complete call for papers.

*IEEE Internet Computing* plans a November/December 2013 special issue on smart cities.

Smart cities are currently the focus of a broad research community as well as of many government and industry innovation agendas. The Internet plays a fundamental role in communication, information sharing and processing, data transfer and analysis, and distributed computing in many of today's cities. The rise of the Internet of Things and the large-scale adoption of Web technologies in urban environments have proved that Internet-based solutions can successfully address smart cities' multifaceted, cross-domain challenges.

This special issue seeks submissions about recent or ongoing research efforts and experiences in applying Internet technologies to realize the smart city vision.

Email the guest editors ([ic6-2013@computer.org](mailto:ic6-2013@computer.org)) a brief description of the article you plan to submit by 15 February 2013. Articles are due **1 March 2013**. Visit [www.computer.org/portal/web/computingnow/icfp6](http://www.computer.org/portal/web/computingnow/icfp6) to view the complete call for papers.

## CALENDAR

### DECEMBER 2012

1-5 Dec: MICRO 2012, IEEE/ACM Int'l Symp. on Microarchitecture, Vancouver; [www.microsymposia.org/micro45](http://www.microsymposia.org/micro45)

3-6 Dec: CLOUDCOM 2012, 4th IEEE Int'l Conf. on Cloud Computing Technology and Science, Taipei, Taiwan; [www.cloudcom.org](http://www.cloudcom.org)

5-7 Dec: RTSS 2012, 33rd IEEE Real-Time Systems Symp., San Juan, Puerto Rico; [www.rtss.org](http://www.rtss.org)

6-8: APSCC 2012, IEEE Asia-Pacific Services Computing Conf., Guilin, China; <http://grid.hust.edu.cn/apsc2012>

10-12 Dec: ICIOS 2012, 1st IEEE Int'l Conf. on Internet Operating Systems, Irvine, California; <http://icios.wordpress.com>

11-14 Dec: ICDM 2012, IEEE Conf. on Data Mining, Brussels; <http://icdm2012.ua.ac.be>

17-19 Dec: SOCA 2012, 5th EEE Conf. on Service-Oriented Computing and Applications, Taipei, Taiwan; <http://conferences.computer.org/soca>

17-20 Dec: DASC 2012, 10th IEEE Int'l Conf. on Dependable, Autonomic and Secure Computing, Changzhou, China; <http://cse.stfx.ca/~dasc2012>

19-21 Dec: HIPC 2012, Int'l Conf. on

High Performance Computing, Pune, India; [www.hipc.org](http://www.hipc.org)

### JANUARY 2013

15-18 Jan: WACV 2013, IEEE Workshop on Applications of Computer Vision, Clearwater Beach, Florida; <http://cvl.cse.sc.edu/wacv2013/index.html>

28-30 Jan: ICOIN 2013, 2013 Int'l Conf. on Information Networking, Bangkok, Thailand; [www.icoin.org](http://www.icoin.org)

28-31 Jan: ICNC 2013, Int'l Conf. on Computing, Networking and Communications, San Diego; [www.conf-icnc.org/2013](http://www.conf-icnc.org/2013)

### FEBRUARY 2013

23-27 Feb: HPCA 2013, IEEE Int'l Symp. on High-Performance Computer Architecture, Shenzhen, China; [www.cs.utah.edu/~lizhang/HPCA19/index.html](http://www.cs.utah.edu/~lizhang/HPCA19/index.html)

## Showcase Your Multimedia Content on Computing Now!

*IEEE Computer Graphics and Applications* seeks computer graphics-related multimedia content (videos, animations, simulations, podcasts, and so on) to feature on its Computing Now page, [www.computer.org/portal/web/computingnow/cga](http://www.computer.org/portal/web/computingnow/cga).

If you're interested, contact us at [cga@computer.org](mailto:cga@computer.org). All content will be reviewed for relevance and quality.

**IEEE Computer Graphics**  
AND APPLICATIONS



## CAREER OPPORTUNITIES

### UNIVERSITY OF NORTH CAROLINA WILMINGTON, COMPUTER SCIENCE (ASSISTANT PROFESSOR, TENURE-TRACK).

Vacancy 13F008 Starts August 2013. Ph.D. in Computer Science or closely related area required. Emphasis in computer graphics, visualization, animation or closely related area. Details at <http://uncw.edu/hr/employment-epa.html> Priority consideration date: January 2, 2013. EEO/AA Employer. Women and Minorities encouraged to apply.

**UNIVERSITY AT ALBANY.** Open Rank Faculty / Computer Science Dept. The Computer Science Department at the University at Albany – SUNY is seeking candidates for an open rank tenure-track faculty position beginning Fall 2013. We seek candidates whose research involves the design and implementation of data analytics techniques or systems that can be used in other areas of Computer Science and/or in other disciplines. Applicants must have a Ph.D. in Computer Science or closely related discipline. Candidates for Associate or Full Professor positions must also have a strong record of funded research. For a complete job description and application procedures, visit: <http://albany.interviewexchange.com/jobofferdetails.jsp?JOBID=35201>.

Questions regarding the position may be addressed to [search2013@cs.albany.edu](mailto:search2013@cs.albany.edu). The Computer Science Department at UAlbany offers B.S., M.S. and Ph.D. degrees in Computer Science. For additional information about the department, please visit <http://www.cs.albany.edu>.

### WASHINGTON UNIVERSITY IN ST. LOUIS, FACULTY POSITIONS.

The Department of Computer Science & Engineering at Washington University in St. Louis seeks outstanding tenure-track faculty in all areas of computer science and engineering at the assistant professor level. Exceptional candidates at the associate and full professor levels will also be considered. The department plans to grow its faculty size by 50% in the coming years. We seek multiple talented and highly motivated individuals who will build transformative research programs, both through work in the core disciplines of computer science and computer engineering and through interdisciplinary collaborations with researchers in areas such as biomedicine, engineering, and the sciences. Successful candidates must show exceptional promise for research leadership and

a strong commitment to high-quality teaching. Candidates will be expected to publish their research in peer-reviewed journals, to teach, and to participate in department and University service. For full information about this search and application instructions, please visit: <http://cse.wustl.edu/aboutthedepartment/Pages/OpenFacultyPositions.aspx>. Applicants should hold a doctorate in Computer Science, Computer Engineering, or a closely related field. Washington University in St. Louis is an Equal Opportunity and Affirmative Action employer and invites applications from all qualified candidates. Employment eligibility verification required upon employment.

### UNIVERSITY OF CALIFORNIA, MERCED, PROFESSOR OF COMPUTER SCIENCE.

The School of Engineering at the University of California at Merced invites applications from distinguished scholars and teachers for a tenured or a tenure-track faculty position in Electrical Engineering and Computer Science. We are seeking candidates with demonstrated excellence in the areas of theory of computing, software engineering, and programming languages. However, exceptionally qualified candidates in other areas of Computer Science and Engineering will also be considered. A Ph.D. in Electrical Engineering, Computer Science, or a related field and demonstrated excellence in research are required. To apply, or for more information, please visit our website: <http://jobs.ucmerced.edu/n/academic/position.jsf?positionId=4263 AA/EOE>.

### MASSACHUSETTS INSTITUTE OF TECHNOLOGY, FACULTY POSITIONS.

The Department of Electrical Engineering and Computer Science (EECS) seeks candidates for faculty positions starting in September 2013. Appointment will be at the assistant or untenured associate professor level. In special cases, a senior faculty appointment may be possible. Faculty duties include teaching at the graduate and undergraduate levels, research, and supervision of student research. We will consider candidates with backgrounds and interests in any area of electrical engineering and computer science. Faculty appointments will commence after completion of a doctoral degree. Candidates must register with the EECS search website at <https://eeecs.mit.edu/Computer>, and must submit application materials electronically to this website. Candidate applications should include a description of professional interests and goals in both teaching and research. Each application should include a curriculum vita and the names and addresses

## BAYLOR UNIVERSITY

### Assistant, Associate or Full Professor of Computer Science

The Department of Computer Science seeks a productive scholar and dedicated teacher for a tenured or tenure-track position beginning August, 2013. The ideal candidate will hold a terminal degree in Computer Science or a closely related field and demonstrate scholarly capability and an established and active independent research agenda in one of several core areas of interest, including, but not limited to, game design and development, software engineering, computational biology, machine learning and large-scale data mining. A successful candidate will also exhibit a passion for teaching and mentoring at the graduate and undergraduate level. For position details and application information please visit: <http://www.baylor.edu/hr/index.php?id=81302>

Baylor, the world's largest Baptist university, holds a Carnegie classification as a "high-research" institution. Baylor's mission is to educate men and women for worldwide leadership and service by integrating academic excellence and Christian commitment within a caring community. Baylor is actively recruiting new faculty with a strong commitment to the classroom and an equally strong commitment to discovering new knowledge as Baylor aspires to become a top tier research university while reaffirming and deepening its distinctive Christian mission as described in Pro Futuris (<http://www.baylor.edu/profuturis/>).

*Baylor is a Baptist university affiliated with the Baptist General Convention of Texas. As an AA/EEO employer, Baylor encourages minorities, women, veterans, and persons with disabilities to apply.*



of three or more individuals who will provide letters of recommendation. Letter writers should submit their letters directly to MIT, preferably on the website or by mailing to the address below. Please submit a complete application by December 15, 2012. Send all materials not submitted on the website to: Professor Anantha Chandrakasan, Department Head, Electrical Engineering and Computer Science, Massachusetts Institute of Technology, Room 38-401, 77 Massachusetts Avenue, Cambridge, MA 02139. M.I.T. is an equal opportunity/affirmative action employer.

**UNIVERSITY OF NEVADA, RENO.** Computer Science and Engineering at UNR invites applications for a tenure-track assistant professor faculty position starting July 1, 2013. More information can be found [www.cse.unr.edu](http://www.cse.unr.edu). Candidates with interest and expertise in big data/cloud computing, embedded systems, or computer games may be given preference. Applicant should be strongly committed to quality research and teaching, expect to develop a robust externally funded research program, supervise MS and PhD students, and participate in service and outreach. Review of applications will begin on January 15, 2013. To apply <https://www.unrsearch.com/postings/11551>. EEO/AA.

**LEAD DEVELOPER.** White Plains, NY. Develop application software for int'l rail travel provider. Master's deg in Computer Science & 1 yr exp in job offered or as Java Developer req'd. Strong exp in Java, Servlets, JSP, JDBC, Spring, XML, JavaScript, Perl, HTML, DHTML req'd. Exp in AJAX, RSS & Web 2.0 technologies, SOAP technology, MySQL, Oracle & Eclipse req'd. Resumes to: Rail Europe, 44 S Broadway, 11th Fl, White Plains, NY 10601 or email resumes to [HR\\_Resources@raileurope.com](mailto:HR_Resources@raileurope.com).

**PROGRAMMER ANALYST.** Dsgn, dvlp, test & implmt, Java, J2EE, Struts2, Tapestry, Oracle Spatial, Oracle intermedia, AWK, Oracle 9i/10g/11g, RAC, Req MS in Comp Sci, Engg or rel. Freq travel reqd. Mail resumes to Sunmerge Systems Inc, 15 Corporate Place South, Ste 430, Piscataway, NJ 08854.

**PROGRAMMER ANALYST.** Iselin, NJ: Travel to multiple client locations nationwide to create, modify, maintain stored procedures for processing business logic (financial domain) for different modules according to user requirements using Sybase (T-SQL), Rapid SQL, PERL, JavaScript in multi-platform environment. Work with Oracle, PL SQL, DB2. Test, troubleshoot,



## Faculty Positions Available in the Department of Computer Science

The Department of Computer Science (CS@VT) at Virginia Tech seeks applicants for tenure-track faculty positions in the following areas:

### Associate Professor in Cybersecurity

The successful candidate will contribute to the research and graduate programs in the National Capital Region (NCR) and collaborate with faculty at Virginia Tech's campus in Blacksburg, VA. This position adds to the collaboration in cybersecurity between the Department of Computer Science and the Bradley Department of Electrical and Computer Engineering (ECE). Candidates should have research interests in systems and network security, trustworthy systems, software security, information security and privacy, or other topics relevant to national critical infrastructure. Candidates should have a record appropriate to an associate professor rank in scholarship, leadership, and interdisciplinary collaboration in cybersecurity. Ideal candidates combine cybersecurity with existing departmental strengths. See [www.cs.vt.edu/FacultySearch](http://www.cs.vt.edu/FacultySearch) for additional information.

The department collaborates with ECE in the newly established Ted and Karyn Hume Center for National Security and Technology ([www.cnst.ictas.vt.edu](http://www.cnst.ictas.vt.edu)) and the NCR Program in Information Assurance with an associated Executive Master's degree and a graduate certificate program. The NCR campus ([www.ncr.vt.edu](http://www.ncr.vt.edu)) is located near the Washington D.C./Falls Church area and houses the Virginia Tech Research Center ([www.ncr.vt.edu/arlington](http://www.ncr.vt.edu/arlington)) in Arlington, VA, enabling significant research opportunities in cyber-security. The new facility is within walking distance of the NSF, ONR, AFOSR, DARPA, and other agencies.

Applications must be submitted online to <https://jobs.vt.edu> reference posting #0122357 or use this direct link ([listings.jobs.vt.edu/applicants/Central?quickFind=196077](https://listings.jobs.vt.edu/applicants/Central?quickFind=196077)). Applicant screening will begin December 31, 2012 and continue until the position is filled. Inquiries should be directed to **Dr. Dennis Kafura, Search Committee Chair**, [kafura@cs.vt.edu](mailto:kafura@cs.vt.edu).

### Assistant Professor in Artificial Intelligence/Machine Learning Blacksburg, VA

Full-time tenure-track position, at the rank of Assistant Professor, from candidates with expertise in artificial intelligence having specific emphasis on machine learning or reasoning under uncertainty. The department is in the process of making multiple hires over multiple years in this area. Candidates should have a record of scholarship, leadership, and collaboration in computing and interdisciplinary areas; demonstrated ability to contribute to teaching at the undergraduate and graduate levels in AI and related subjects; sensitivity to issues of diversity in the campus community; and the skills to establish and grow a multidisciplinary research group. Early applications are encouraged. Applications must be submitted online to <https://jobs.vt.edu> for posting #0122414.

The department is home to the Discovery Analytics Center ([dac.cs.vt.edu](http://dac.cs.vt.edu)), a university-wide effort that brings together faculty with strengths in machine learning, big data, and data mining applied to problems of national interest. There also are rich opportunities in a highly collaborative department with strengths in HCI, HPC, computational biology and bioinformatics, information retrieval, software engineering, CyberArts, and CS education. Beyond the department, there are opportunities for collaboration in machine learning with faculty in ECE and Statistics. Research on security and personal health informatics is possible in collaboration with the VT-Carilion Research Institute associated with the VT-Carilion School of Medicine. Applicant screening will begin December 31, 2012 and continue until the position is filled. Inquiries should be directed to **Dr. Doug Bowman, AI/ML Search Committee Chair**, [bowman@vt.edu](mailto:bowman@vt.edu).

### Assistant, Associate, or Full Professor in Systems Blacksburg, VA

Candidates with research breadth and depth across several areas of computer systems, including architecture, operating systems, and networking are sought and researchers in the areas of compilers, run-time systems, and parallel and distributed systems are especially encouraged to apply. Candidates should have a record of scholarship and collaboration in computing and interdisciplinary areas; demonstrated ability to contribute to teaching at the undergraduate and graduate levels; and sensitivity to issues of diversity in the campus community. Applications must be submitted online to <https://jobs.vt.edu> for posting #0122413. Applicant screening will begin December 31, 2012 and continue until the position is filled. Inquiries should be directed to **Dr. Kirk W. Cameron, Search Committee Chair**, [cameron@cs.vt.edu](mailto:cameron@cs.vt.edu).

The Department of Computer Science (CS@VT) has 35 tenure-track research oriented faculty including 12 NSF CAREER award winners. Ph.D. production among the top 30 in the USA, and annual research expenditures exceeding \$6.5 million. CS@VT is in the College of Engineering whose undergraduate program was ranked 16th among all accredited engineering schools, and sixth among public universities and whose graduate program was ranked 24th by *US News & World Report* in fall 2012. In 2010, CS@VT was ranked 5th in the recruiting quality of computer science undergraduate majors by the *Wall Street Journal*. Recently, the department has attracted high-profile research funding including several multi-million dollar awards from diverse sources, e.g., IARPA, NSF, DOE, and ARO.

Salary for suitably qualified applicants is competitive and commensurate with experience.

*Virginia Tech is an equal opportunity/affirmative action institution.*

## University of Illinois at Urbana-Champaign

The Department of Electrical and Computer Engineering (ECE) at the University of Illinois at Urbana-Champaign invites applications for faculty positions at all levels and in all areas of electrical and computer engineering, but with particular emphasis in the areas of bioinformatics and systems biology, controls, energy and power systems, nanoelectronics, nanophotonics devices, circuits and systems, computer systems, parallel computing, reliable computing, and distributed systems. Applications are encouraged from candidates whose research programs are in traditional as well as in nontraditional and interdisciplinary areas of electrical and computer engineering. The department is engaged in exciting new and expanding programs for research, education, and professional development, with strong ties to industry.

Applicants for positions at the assistant professor level must have an earned Ph.D. or equivalent degree, excellent academic credentials, and an outstanding ability to teach effectively at both the graduate and undergraduate levels. Successful candidates will be expected to initiate and carry out independent research and to perform academic duties associated with our B.S., M.S., and Ph.D. programs. Senior level appointments with tenure are available for persons of international stature.

Faculty in the department carry out research in a broad spectrum of areas and are supported by world-class facilities, including the Coordinated Science Laboratory, the Information Trust Institute, the Micro and Nanotechnology Laboratory, the Beckman Institute for Advanced Science and Technology, as well as several industrial centers and programs that foster international collaborations. The department has one of the leading programs in the United States, granting approximately 350 B.S. degrees, 100 M.S. degrees, and 60 Ph.D. degrees annually.

In order to ensure full consideration by the Search Committee, applications must be received by December 15, 2012. Salary will be commensurate with qualifications. Preferred starting date is August 16, 2013, but is negotiable. Applications can be submitted by going to <http://jobs.illinois.edu> and uploading a cover letter, CV, research statement, and teaching statement, along with names of three references. For inquiry, please call 217-333-2302 or email [ece-recruiting@illinois.edu](mailto:ece-recruiting@illinois.edu).

*Illinois is an Affirmative Action /Equal Opportunity Employer and welcomes individuals with diverse backgrounds, experiences, and ideas who embrace and value diversity and inclusivity ([www.inclusiveillinois.illinois.edu](http://www.inclusiveillinois.illinois.edu)).*

## BAYLOR UNIVERSITY Lecturer of Computer Science

The Department of Computer Science seeks a dedicated teacher and program advocate for a lecturer position beginning August, 2013. The ideal candidate will have a master's degree or Ph.D. in Computer Science or a related area, a commitment to undergraduate education, effective communication and organization skills, and industry/academic experience in game development, especially with graphics and/or engine development. For position details and application information please visit: <http://www.baylor.edu/hr/index.php?id=81302>.

Baylor, the world's largest Baptist university, holds a Carnegie classification as a "high-research" institution. Baylor's mission is to educate men and women for worldwide leadership and service by integrating academic excellence and Christian commitment within a caring community. Baylor is actively recruiting new faculty with a strong commitment to the classroom and an equally strong commitment to discovering new knowledge as Baylor aspires to become a top tier research university while reaffirming and deepening its distinctive Christian mission as described in Pro Futuris (<http://www.baylor.edu/profuturis/>).

*Baylor is a Baptist university affiliated with the Baptist General Convention of Texas. As an AA/EEO employer, Baylor encourages minorities, women, veterans, and persons with disabilities to apply.*

maintain existing code. Reply to: Magnum Infotech, Inc., 33 Wood Avenue S, #600 Iselin NJ 08830.

**CONSULTANT.** F/T (Poughkeepsie, NY) Position involves travel to various unanticipated worksites up to 100% of the time anywhere in the United States. Must have Bach deg or the foreign equiv in Technology, Comp Sci & Engg, Comp Engg, or related with two (2) yrs of exp building dynamic websites, web applications and web services using ASP.Net, C#.Net, VB.Net, XML, Telerik Controls and SQL Server 2005. Send resume: Indotronic Int.l Corp., Recruiting (RS), 331 Main St, Poughkeepsie, NY 12601.

**ETL/DATA STAGE DEVELOPER** sought by GSPANN Technologies, Inc. in Milpitas, CA w/ Master's in Comp Sci or related. Responsibilities incl providing professional comp consulting services in form of systems analysis, dsngn & dvlpmnt, systems integration &/or testing consulting. Mail resumes to 362 Fairview Way, Milpitas, CA 95035 attn: HR.

**PRINCIPAL SYSTEMS ARCHITECT** sought by Nexius Solutions Inc. (Allen, TX) w/ Comp/Electronic Engg or rlted deg w/ 5 yrs exp. Job duties: To decide on core network mgmt technological choices for wireless & telecommunications networks; identify product & technical reqmts & work w/potential suppliers. Lead dsngn, implmtn & integration of element mgmt systems & network mgmt system for devise. Possible relocation to Fairfax, VA. Mail Resumes to 1301 Central Expressway S., Ste 200, Allen, TX 75013. Attn HR coordinator.

**SOFTWARE ENGINEER.** (Vienna, VA) Analyze, dsngn, dvlp, test & implmt data warehouses, web based applics & applic systems & s/w using Oracle 8, Perl, C++, XML, ASP, Cold Fusion, WebSphere, Korn Shell Scripts, HTML, DHTML, JSP, JDBC, Using JumpStart, SunInstall, WebStart, KickStart & Symantec, Unix & Windows 98/00/NT. Reqs MS Sci, Comp Sci or Business. Mail resumes to SMK Soft Inc., 8230 Boone Blvd, Ste 430., Vienna, VA 22182

**SOFTWARE ENGINEER, TEST ENGINEERING** - Dev. framework for testing next-gen. Visual Analytics and Collaboration suite of software. Reqs BS or foreign equiv. deg. in Comp. Sci., Engg., or a rlted. field + 5 yrs of prog., post-bacc. exp., which includes 3 yrs of exp. in testing computer software utilizing a high-level programming language; designing and implementing automation frameworks; developing and maintaining automated tests; testing and profiling large-scale C++ systems; testing highly scalable Java and/or Ruby server systems that back dynamic, highly interactive web experi-

ences; and creating test specifications and test plans. Any suitable combination of education, training, or experience is acceptable. Position at Tableau Software in Kirkland, WA. To apply, please e-mail resume and cover letter to [jobstableau@tableausoftware.com](mailto:jobstableau@tableausoftware.com).

**QUALITY ASSURANCE ANALYST** - Use of SQL to test custom built s/ware applics to ensure bug fixes & new features work per specifications; create & manage tickets using co. ticket tracking system for in-house applics; provide training to existing/new users, applic support team & dvlpmt members on existing applics/features; lead the applic support team & assist w/solving issues reported via the applic support ticketing system; & automate existing test cases. Min. req. MS in Info Technology. Resumes to Job Location: InnerWorkings, Inc. 600 W. Chicago Ave., Ste 850, Chicago, IL 60654.

**SERVICES CONSULTANT** (Islandia NY & locs throughout US). Understand client's bus. needs & collaborate w/ architect to prep dsgn docs. Dvlp, implmt & config CA Clarity PPM solution. REQS: Bachelor's or foreign equiv in Comp Sci, Math, Engg (any field), Bus. (any field) or rel + 2 yrs exp in job &/or rel occup; must have exp w/ Implmntg & configuring CA Clarity PPM solution; Engaging in customer-facing prof services consulting; Certified as CA Clarity PPM Bus. Analyst &/or CA Clarity PPM Professional; Frequent travel reqd; Work from home benefit available. Send resume to: Althea Wilson, CA Technologies, One CA Plaza, Islandia, NY 11749, Refer to Requisition #29522.

**PROGRAMMER ANALYSTS** (multiple positions): Analyze, dsgn, dvlp, test & support applications/systems based on bus./



### DEPARTMENT HEAD

Nominations and applications are being solicited for the position of Head of the Bradley Department of Electrical and Computer Engineering (ECE). Candidates should have demonstrated leadership and management skills to lead the department to become one of the premier ECE departments in the nation. Candidates must qualify for tenure at the rank of professor and should have achieved distinction in university-level teaching and research and have a record of superior scholarship, administrative ability, and leadership.

Complete position information, application procedures, and the review process are available at <http://www.ece.vt.edu/>. Please apply online at <https://jobs.vt.edu>, posting 0122299.

EO/AA



## FLORIDA INTERNATIONAL UNIVERSITY

Florida International University is a multi-campus public research university located in Miami, a vibrant, international city. FIU is recognized as a Carnegie engaged university. Its colleges and schools offer more than 180 bachelor's, master's and doctoral programs in fields such as computer science, engineering, international relations, architecture, law, and medicine. As one of South Florida's anchor institutions, FIU is worlds ahead in its local and global engagement, finding solutions to the most challenging problems of our time. FIU emphasizes research as a major component of its mission and enrolls 48,000 students in two campus and three centers including FIU Downtown on Brickell and the Miami Beach Urban Studios. More than 160,000 alumni live and work in South Florida. For more information about FIU, visit <http://www.fiu.edu/>.

The School of Computing and Information Sciences seeks exceptionally qualified candidates for multiple tenure-track and tenured faculty positions at all levels as well as non-tenure track faculty positions at the level of Instructor.

### TENURE TRACK/TENURED POSITIONS (JOB ID# 505004)

We seek well-qualified candidates in all areas of Computer Science and researchers in the areas of programming languages, compilers, databases, information retrieval, computer architecture, scientific computing, big data, natural language processing, computational linguistics, health informatics, and robotics, are particularly encouraged to apply. Preference will be given to candidates who will enhance or complement our existing research strengths.

Ideal candidates for junior positions should have a record of exceptional research in their early careers. Candidates for senior positions must have an active and proven record of excellence in funded research, publications, and professional service, as well as a demonstrated ability to develop and lead collaborative research projects. In addition to developing or expanding a high-quality research program, all successful applicants must be committed to excellence in teaching at both graduate and undergraduate levels. An earned Ph.D. in Computer Science or related disciplines is required.

### NON-TENURE TRACK INSTRUCTOR POSITIONS (JOB ID# 505000)

We seek well-qualified candidates in all areas of Computer Science and Information Technology. Ideal candidates must be committed to excellence in teaching a variety of courses at the undergraduate level. A graduate degree in Computer Science or related disciplines is required; significant prior teaching and industry experience and/or a Ph.D. in Computer Science is preferred.

Florida International University (FIU), the state university of Florida in Miami, is ranked by the Carnegie Foundation as a comprehensive doctoral research university with high research activity. The School of Computing and Information Sciences (SCIS) is a rapidly growing program of excellence at the University, with 36 faculty members and over 1,500 students, including 75 Ph.D. students. SCIS offers B.S., M.S., and Ph.D. degrees in Computer Science, an M.S. degree in Telecommunications and Networking, and B.S., B.A., and M.S. degrees in Information Technology. SCIS has received approximately \$17.5M in the last four years in external research funding, has six research centers/clusters with first-class computing infrastructure and support, and enjoys broad and dynamic industry and international partnerships.

### HOW TO APPLY:

Applications, including a letter of interest, contact information, curriculum vitae, academic transcript, and the names of at least three references, should be submitted directly to the FIU Careers website at <https://jobsearch.fiu.edu>; refer to Job ID# 505004 for tenure-track or tenured positions and to Job ID# 505000 for instructor positions. The application review process will begin on January 7, 2013, and will continue until the position is filled. Further information can be obtained from the School website <http://www.cis.fiu.edu>, or by e-mail to [recruit@cis.fiu.edu](mailto:recruit@cis.fiu.edu).

*FIU is a member of the State University System of Florida and is an Equal Opportunity, Equal Access Affirmative Action Employer.*

**Department of Electrical Engineering  
and Computer Science**  
**University of Kansas:**  
**Computer Science/Computer Engineering Faculty**

The University of Kansas (KU) Department of Electrical Engineering and Computer Science (EECS) seeks outstanding individuals for three tenure track positions in the disciplines of computer engineering or computer science. Successful candidates are expected to contribute to the development of academic and research programs and to contribute to the research community. Successful candidates must have an earned doctorate or equivalent in computer science, computer engineering, or related fields at the time of joining the department.

EECS leads the KU School of Engineering with 36 faculty members and a research volume of over \$10 million per year. The EECS department offers undergraduate and graduate degrees in electrical engineering, computer engineering, computer science, interdisciplinary computing, and information technology. The department has approximately 450 undergraduate and 250 graduate students. The EECS faculty collaborate on research opportunities that cross language, compiler, architecture, high-performance computing, and scientific computing topics, among others, within and outside the department.

### Operating Systems

We are interested in those candidates exploring new ideas in advanced operating systems, distributed systems, file and storage systems, embedded systems, resilient systems, virtualization, and multi-core computing, with the focus on computer systems.

Three letters of recommendation and questions should be sent separately to Dr. Prasad Kulkarni, by emailing to [prasadk@ku.edu](mailto:prasadk@ku.edu).

### Bioinformatics

This search is focused on those with expertise in machine learning, data mining, statistical learning, distributed databases, big data analytics; all focused on computational life sciences problems. Other areas of computer science focused on computational life sciences maybe considered for exceptional applicants. Candidates are sought for assistant and associate professor level. Demonstrated research and academic leadership is required for the senior rank. KU strongly supports leading life sciences research in all aspects. There are many interdisciplinary collaboration opportunities involving different schools at KU using high throughput sequencing, high content screening, mass spectrometry, and brain imaging, to name a few examples. KU Medical Center is an NIH designated Cancer Center. Three letters of recommendation and questions should be sent separately to Dr. Jun Huan by emailing to [EECS\\_bio\\_search@ku.edu](mailto:EECS_bio_search@ku.edu).

### High Performance Computing

This search is focused on those with expertise in high performance computing (HPC), including parallel computing on HPC systems employing multi-core, GPU, or special-purpose architectures, parallel and distributed algorithms, and data-intensive computing. Exceptional candidates in related areas of computer science/engineering focused on computational science may also be considered. Candidates are sought for the assistant professor level. There are many collaboration opportunities with established language, compiler, architecture, and scientific computing researchers both within and outside the department. There are many interdisciplinary collaboration opportunities involving different schools at KU with high performance computing needs, such as the KU Medical Center, a NIH designated Cancer Center. Three letters of recommendation and questions should be sent separately to Dr. Joe Evans by emailing to [evans@ku.edu](mailto:evans@ku.edu).

The KU School of Engineering is rapidly expanding and plans to add thirty new faculty lines in the next 5 years with expand research and teaching facilities. The University of Kansas is focused on four key campus-wide strategic initiatives: (1) Sustaining the Planet, Powering the World; (2) Promoting Well-Being, Finding Cures; (3) Building Communities, Expanding Opportunities; and (4) Harnessing Information, Multiplying Knowledge. For more information, see <http://www.provost.ku.edu/planning/themes/>. Successful candidates will address KU's themes.

The appointment will be effective as negotiated. Applications and nominations should be submitted at <http://www.ku.edu/employment/> under faculty. Applications should include a letter of application, curriculum vita, a statement of research interests and future plans, a statement of teaching interests and future plans. Applications will be reviewed beginning December 1, 2012 and will be accepted until the position is filled. Equal Opportunity Employer M/F/D/V

end user reqmts utilizing knowl of & exp w/Oracle 10g/11g; SQL Server 2005/2008; SQL; PL/SQL; JAVA; J2EE; Web Sphere; Web Services; SOA; XML; TOAD; SQL DEVELOPER; HTML; Apache; IIS; Java Script; CSS; DHTML; Windows NT/XP; & UNIX. Travel req. to unanticipated client sites in USA. Min. Req. MS in Comp Sci, Eng. discipline, or related. Resumes to Job Location: Aarkay Technologies Inc., 852 Gold Hill Rd., Ste. 205, Fort Mill, SC 29708.

**BUSINESS ANALYST** needed to develop and maintain financial databases and computer software systems. Job located in Midland, TX. Mail resumes to Midland Central LLC, 1203 N. Lamesa Road, Midland, TX 79701. No walk-ins.

**DBA LEADS** Troy, MI area. Work w/ database system clusters on mainframes, db2 UDB, & IMS w/ COBOL, CICS & JAVA apps. Plan & execute database related projects like database system upgrades, data migration, normalization, performance tuning, high-availability & disaster recovery. Must possess a MS in Software Engg, Computer Engg, Computer Sci or related + 36 months as a Computer Software Professional. Travel/reloc as req. Send res to Unified Business Technologies, Inc. and designate position to 3250 West Big Beaver Rd, Ste 329, Troy MI 48084.

## THE UNIVERSITY OF MINNESOTA— TWIN CITIES

The University of Minnesota – Twin Cities invites applications for faculty positions in **Electrical and Computer Engineering** from individuals with a strong background in core areas of ECE, particularly (1) power and energy systems and (2) systems, communications, and controls, with interests in bio- or medical-imaging, big data, information processing, or systems biology. Women and other underrepresented groups, and those with strong interdisciplinary interests, are especially encouraged to apply. An earned doctorate in an appropriate discipline is required. Rank and salary will be commensurate with qualifications and experience. Positions are open until filled, but for full consideration, apply at <http://www.ece.umn.edu/> by January 4, 2013. The University of Minnesota is an equal opportunity employer and educator.



**BT AMERICAS, INC.** has an opening for Sr. Security Systems Engineer in El Segundo, CA to provide support in life service Security & Network solutions. Requires MS degree + 2 yrs exp. less than 5% domestic/int'l travel. Apply online at [www.btamericascareers.com](http://www.btamericascareers.com) Job Code #3822. EOE.

**SR. SOFTWARE DEVELOPER.** IT Company in Calabasas, CA has an opening for Sr. Software Developer. Define the software system architecture which include high level design, coding, defining test strategy and security restrictions, among others. F/T, requires Bachelor's Degree plus 5 yrs. Experience in job or related occupation. If interested please send this ad and your resume to Pro Soft-net Corp., Attn: HR 26115 Mureau Rd. Ste. A, Calabasas, CA 91302.

**ENGAGEMENT MANAGER.** Jacksonville, FL: Future Technology Associates seeks Engagement Manager to oversee overall planning, investment brief authoring, budgeting, resource allocation, design, development & resource mgmt for all phases; Understand & apply complex concepts from computer science in business context for solving business or operational issues; Req Master's degree in Info Systems Mgmt or related

field & 2 yrs exp in each of the following: Proficiency in Microsoft Office Suite; Implementing best practices in systems development; SDLC best practices; Enterprise data mgmt concepts, designs & implementations; Agile Methodologies; Project Mgmt. Also requires travel &/or relocation to client sites at unanticipated locations anywhere in the U.S. Worker may telecommute 1-2 days/wk. Email resume to [trendell@fta-llc.com](mailto:trendell@fta-llc.com).

**IT PROFESSIONALS.** TechDemocracy, LLC has multiple openings for the following positions at its office in Edison, NJ, and unanticipated sites throughout the U.S.: § Software Engineers - Gather and analyze user requirements, design and develop new software. Handle systems development of life cycle. Experience Required. § Computer Programmers/ Programmer Analysts - Work under supervision or independently, gather data prepare requirements and specifications, design detailed flowcharts and generate standardized code. Test, debug, and install the operating programs and procedures. Experience required. § Technical Systems Architects -Perform architectural design and integration for complex, cross-functional systems. Identify opportunities for improvements to meet customer needs. Experience required.



**Department of  
Computer and  
Information Sciences  
Temple University  
Tenure Track Faculty**

Applications are invited for tenure-track, open rank, faculty positions in the Department of Computer and Information Sciences at Temple University. The junior position is in the software systems area, which includes

- Software Engineering and Applications,
- Database Systems, and
- Programming Languages.

The senior position for Associate or Full Professor is open to all areas of computer science/engineering. Applicants for the senior position are expected to have an outstanding track record.

Please submit applications with all requested information online at <http://academicjobsonline.org>.

For further information check <http://www.cis.temple.edu> or send email to search committee chair Dr. Eugene Kwatny at [ekwatny@temple.edu](mailto:ekwatny@temple.edu). Review of candidates will begin on January 2, 2013 and will continue until the positions are filled. Temple University is an equal opportunity, equal access, affirmative action employer.



## THE HONG KONG UNIVERSITY OF SCIENCE AND TECHNOLOGY

### Department of Computer Science and Engineering Faculty Positions

The Department of Computer Science and Engineering, HKUST (<http://www.cse.ust.hk/>) has more than 40 faculty members, recruited from major universities and research institutions around the world, and about 800 students (including about 200 postgraduate students). The medium of instruction is English. In 2012, we were ranked 13<sup>th</sup> among all Computer Science and Engineering Departments worldwide according to QS World University Ranking, and 26<sup>th</sup> according to Academic Ranking of World Universities.

The Department will have at least one tenure-track faculty opening at Assistant Professor/Associate Professor/Professor levels for the 2013–2014 academic year. We are looking for candidates with interests in **Security**, or **Systems**. Strong candidates in core computer science and engineering research areas will also be considered. Applicants at Assistant Professor level should have an earned PhD degree and demonstrated potential in teaching and research.

Salary is highly competitive and will be commensurate with qualifications and experience. Fringe benefits include medical and dental benefits and annual leave. Housing benefits will also be provided where applicable. For appointment at Assistant Professor/Associate Professor level, initial appointment will normally be on a three-year contract. A gratuity will be payable upon completion of contract.

Applications should be sent through e-mail including a cover letter, curriculum vitae (including the names and contact information of at least three references), a research statement and a teaching statement (all in PDF format) to [csrecruit@cse.ust.hk](mailto:csrecruit@cse.ust.hk). Priority will be given to applications received by **28 February 2013**. Applicants will be promptly acknowledged through e-mail upon receiving the electronic application material.

*(Information provided by applicants will be used for recruitment and other employment-related purposes.)*

## CAREER OPPORTUNITIES



Cisco Systems, Inc. is accepting resumes for the following position in

Irvine, CA:

## IT Program Manager

(Ref#: IRV11)

Manage and lead strategic and global IT programs that have a significant impact across a large client base.

Please mail resumes with reference number to Cisco Systems, Inc., Attn: B51M, 170 W. Tasman Drive, Mail Stop: SJC 5/1/4, San Jose, CA 95134. No phone calls please. Must be legally authorized to work in the U.S. without sponsorship. EOE.

[www.cisco.com](http://www.cisco.com)



Cisco Systems, Inc. is accepting resumes for the following position in

Chicago, IL:

## Network Consulting Engineer

(Ref#: CHI1)

Responsible for the support and delivery of Advanced Services to company's major accounts.

Please mail resumes with reference number to Cisco Systems, Inc., Attn: J51W, 170 W. Tasman Drive, Mail Stop: SJC 5/1/4, San Jose, CA 95134. No phone calls please. Must be legally authorized to work in the U.S. without sponsorship. EOE.

[www.cisco.com](http://www.cisco.com)

§ Management Systems Analysts- Develop, implement design of system level requirements. Finalize systems requirements and application architecture. Build process and code migration on various platforms. Experience required. § Security Analysts- Plan, coordinate and implement security measures for information systems. Analyze and develop appropriate responses to computer security breaches. Experience required. Attractive compensation. Travel and relocation possible. Please mail resume, with salary history and position applied for to: Tech-Democracy, LLC, 499 Thornall Street, 3rd Fl., Edison, New Jersey 08837. Attention: Human Resources.

**SOFTWARE ENGINEER** (Columbus, OH) Dsgn, implmt, test & maintain applications using Oracle SQL, PL/SQL, JAVA Oracle 11g, 10g, 9i, Performs Oracle Application 11i & R12 admin tasks, Backup & Recovery using Rman, Rac, Asm, Dataguard, Streams, Oracle Forms, Perl, Shell scripts, Unix & Windows XP/2000/2003/2008. Must be willing to travel & reloc. Reqs MS Comp Sci, Eng or rel. Mail resumes to Technology Software, 1505 Bethel Rd, Ste 301, Columbus, OH 43220.

**SIEMENS PLM SOFTWARE INC.** has an opening in Shoreview, MN for Software Engineer Adv. to design, develop, modify & implement software programming for products. Requires BS & 3 yrs. exp. in prof. software development. Email resumes to [PLMCareers@ugs.com](mailto:PLMCareers@ugs.com) & refer to Job code UGS97. EOE.

**SIEMENS PLM SOFTWARE INC.** has an opening in Plano, TX & various unanticipated worksites thru-out the U.S. for Solution Architect to implement, deploy & consult on Teamcenter solutions. Requires BS & 5 yrs. exp. & 75% domestic travel. Email resumes to [PLMCareers@ugs.com](mailto:PLMCareers@ugs.com) & refer to Job code UGS99. EOE.

**SIEMENS PLM SOFTWARE INC.** has an opening in Milford, OH for Software Engineer to work on NX Modeling software development projects. Requires MS or completion of degree reqs towards MS

& Graduate coursework. Email resumes to [PLMCareers@ugs.com](mailto:PLMCareers@ugs.com) & refer to Job code UGS117. EOE.

**SOFTWARE ENGINEER UI/UX** (N. Reading, MA) Must hv BS in CS, Engg, s/ware dvlpmt, math or info systems or foreign equiv & 3 yrs exp in job offd or in s/ware dvlpmt including 1 yr of user interface dvlpmt in Flex; or a MS in CS, Engg, s/ware dvlpmt, math or info systems or foreign equiv & 2 yr exp in job offd or in s/ware dvlpmt including 1 yr of user interface dvlpmt in Flex. Send resumes to Mary Beth Christopher, Kiva Systems, Inc., 300 River Park Dr., N. Reading, MA 01864 or to [mchristopher@kiva-systems.com](mailto:mchristopher@kiva-systems.com). Refer to job#003.

**SENIOR DB2 DEVELOPER.** Miami, FL. MSc or BSc plus 5 yrs exp req'd. AIX/UDB, Unix, stored DB2 procedure & SQL exp req'd. Architectural knowldg & exp of IBM systems w/ multi-partitioning environment at Enterprise level req'd. Strong data modeling & analytical exp req'd. TracFone Wireless, resumes only via email to: [PMurphy@tracfone.com](mailto:PMurphy@tracfone.com).

**PRINCIPAL CONSULTANT** - New York, NY. Assess the security properties of computer applications, networks, frameworks, embedded devices, and mobile applications and devices like Android, Windows Phone, iOS, RIM BlackBerry, Apache and IIS servers, thick clients, and Class B corporate networks, and develop exploits for the same. Analyze cryptographic properties of software, modules, and algorithms, and test for design and implementation flaws affecting security. Reverse engineer and modify software applications for platforms including Android, Windows Phone, iOS, Java, .NET, and native languages (C/C++). Perform manual source code reviews and develop applications in the following languages: Assembly, C/C+++, .NET, Java, Objective-C, Groovy, SQL, HTML. Will use a wide range of tools including Mallory, Burp, IDA Pro, Nessus, nmap, sqlmap, Backtrack, Peach, ILSpy, gdb efficiently for a variety of assessments. Travel may be required. Required: Master's degree in Science, Information Technology or

**CLASSIFIED LINE AD SUBMISSION DETAILS:** Rates are \$400.00 per column inch (\$600 minimum). Eight lines per column inch and average five typeset words per line. Send copy at least one month prior to publication date to: Marian Anderson, Classified Advertising, Computer Magazine, 10662 Los Vaqueros Circle, Los Alamitos, CA 90720; (714) 821-8380; fax (714) 821-4010. Email: [manderson@computer.org](mailto:manderson@computer.org).

MIS. Bachelor's degree in related field and 5 years of experience is acceptable in lieu of Master's degree in related field. Any suitable combination of education, training and experience would be acceptable. Send resume to Intrepidus Group, Inc., 119 Fifth Avenue, Suite 702, New York, NY 10003.

**PROGRAMMER ANALYSTS** (mult positions) dsgn & dvlp Microsoft C#.Net, WCF Services, SharePoint & SQL D/base Stored Procedures; perform unit & integration testing; & create web applic(s) using ASP.NET & C#. Req. MS in Comp Sci. or Engg. Travel req. to unanticipated client sites in USA. Resume to Job Loc: InfoLogitech Inc., 50 Cragwood Road, Ste 209, South Plainfield, NJ 07080.

**SOFTWARE DEVELOPER** req. by software development co. w/ BS in rlted Comp Sci field to provide applics, dsgn solutions & feasibility assessments. Lead & mentor co. teams. Perform maintenance. Support & analyze s/ware issues. Dsgn solutions for s/ware framework, algorithms, & code structure. Program & create test cases for quality control. Implmt technologies & maintain networks. Job loc: Sterling, VA. Send res to Spurgetech LLC, 21580 Atlantic Blvd., Ste # 220B Sterling, VA 20166.

**PEOPLESOFT DEVELOPER.** App maintenance & devel., enhancem., new module installation etc. for PeopleSoft v9.x Financial/Supply Chain sys (GL, AP, AM, PO, EXP, ePro). Assist production support resol., project, sys test & validation. Devel. tech docs for all phases of PeopleSoft SDLC. Use SQL, PL/SQL, PeopleSoft devel. & Reporting tools, Oracle dbases. Travel 5%. MS CS or Engg + 3 yrs relevant exp or BS +5 yrs. Email [Rasha.Kamel@laureate.net](mailto:Rasha.Kamel@laureate.net) w/ Job #9131 in subj. line. Laureate Education, Inc. 650 S Exeter St. Balto. MD 21202. EOE.

**DIRECTOR, RECRUITING.** IT Consulting company based in Portland, Oregon has an opening for a "Director, Recruiting". This position is a member of the executive team responsible for planning, staffing, managing, personnel, process and procedure development and providing day to day leadership of geographically diverse, fast-paced recruiting team. Requires Bachelor's Degree or equivalent plus 5 yrs. progressive experience in job or related occupation. Travel required with expenses paid by the employer. If interested please send this ad and your resume to C3G, Attn: Linda Welsh, 121 SW Salmon St. #1100, Portland OR 97204.

## Fujitsu Network Communications, Inc.

has a job opportunity available in  
Sunnyvale, CA

## Software Development Engineer

(Req #FNC02017)

Responsible for the requirement analysis, design, development and support of Network Management System product suite developed to manage Fujitsu Network Elements. Submit resume to Fujitsu Network Communications, Staffing Department, 2801 Telecom Pkwy, Richardson, TX 75082. Must reference Req. #FNC02017.



## TENURE-TRACK FACULTY POSITION IN THE DEPARTMENT OF ELECTRICAL AND COMPUTER ENGINEERING AT THE GEORGE WASHINGTON UNIVERSITY

The Department of Electrical and Computer Engineering at The George Washington University invites applications for a tenure-track position at the Assistant/Associate Professor Rank in the area of High-Performance Computing or Computer Hardware Systems for Biomedical Engineering, Bioinformatics, or Computational Biology. Successful candidates may start as early as the Fall semester 2013.

The department has well-established graduate and undergraduate programs in Electrical, Biomedical, and Computer Engineering. In addition, the University has initiatives designating Biomedical Engineering, Energy, High Performance Computing, and Nano-Technology as areas of excellence. Under construction is a 500,000 sq. ft. Science and Engineering Hall that will open in 2015 and house state-of-the-art clean rooms, imaging facilities, and research and instructional laboratories (<http://www.gwu.edu/scienceandengineeringhall/>). The George Washington University is located in the nation's capital near many federal funding agencies and government research laboratories.

**Responsibilities:** The successful candidate for this position will be expected to develop externally-sponsored research programs, supervise graduate students, and contribute to the teaching and academic advising of students at all levels. Teaching responsibilities include developing and delivering both undergraduate and graduate courses and laboratories in areas that may include some combinations of digital design, embedded systems, biomedical engineering, and computational biology and bioinformatics. The successful candidate will undertake interdisciplinary research in computer engineering and biomedical engineering aimed at using high-performance computing, reconfigurable computing, and embedded systems to advance biomedical engineering in areas such as computer and robotics assisted surgery, computational biology, imaging, and/or bioinformatics.

**Basic Qualifications:** Applicants for the Associate Professor Rank are expected to have a Ph.D. in Biomedical, Computer, or Electrical Engineering, or a closely related field. They should have strong records of attracting research funding, peer-reviewed publications, and teaching, as evidenced by teaching evaluations and recognition of teaching excellence.

Applicants for the Assistant Professor Rank must complete all degree requirements for the Ph.D. in Biomedical, Electrical, or Computer Engineering, or a closely related field, before September 1, 2013, to be appointed as an assistant professor. In addition, applicants must: 1) demonstrate strong research potential, as evidenced by peer-reviewed publications; and 2) demonstrate substantial potential to attract extramural research funding.

Applicants are expected to have significant experience in designing and implementing experimental cross-disciplinary systems, and to have a demonstrated commitment to the responsibilities listed above.

**How to Apply:** To be considered, applicants must complete an online faculty application specific to the rank of interest and upload (i) a brief statement of interest, (ii) a curriculum vitae, (iii) a statement of research and teaching interests, (iv) a sample of three publications, (v) a representative sample of course evaluations or teaching assessments, if applicable, and (vi) complete contact information for at least five references.

For Associate Rank, please visit <https://www.gwu.jobs/postings/11953>.

For Assistant Rank, please visit <https://www.gwu.jobs/postings/11952>.

Review of applications will begin on 1/1/2013 and will continue until the position is filled.

*The George Washington University is an Equal Opportunity/Affirmative Action Employer.*

**Apple** is looking for qualified individuals for following 40/hr/wk positions. To apply, mail your resume to 1 Infinite Loop, M/S: 104-1GM, Attn: LJ, Cupertino, CA 95014 with Req # and copy of ad. Job site & interview, Austin, TX. Principals only. EOE.

## Physical Design Engineer

[Req. #21309883]

Responsible for physical design of high speed large blocks, about 1 million instances, floor planning, placement, timing optimization, clock tree synthesis, routing, and post route optimization. Requires Bachelor's degree, or foreign equivalent, in Electrical Engineering, Electronic Engineering, Computer Science, or related field plus five (5) years professional experience in job offered or in a related occupation. Professional experience must be post-baccalaureate and progressive in nature. Must have professional experience with: physical design of a block in the chip; closing timing at block level in a chip, deep sub-micron circuit phenomena including cross talk, temperature inversion, sub-threshold conductance and impact on leakage current and power; performing Engineering Change Order (ECO) on the physical design; performing Design Rule Checks (DRC) and Layout versus schematic (LVS) checks. Requires 4% international travel.

**Apple** is looking for qualified individuals for following 40/hr/wk positions. To apply, mail your resume to 1 Infinite Loop, M/S: 104-1GM, Attn: LJ, Cupertino, CA 95014 with Req # and copy of ad. Job site & interview, Maiden, NC Principals only. EOE.

## Senior Systems Engineer (3 Openings)

[Req. #13966804]

Responsible for day-to-day standard administration (e.g., account creation, system audits, third-level troubleshooting) and engineering duties (e.g., patch installation, operating system upgrades and installs). Req's Bachelor's degree, or foreign equivalent in Electronic Engineering, Computer Engineering, Electrical Engineering, Physics or related. Five (5) years professional experience in job offered or in a related occupation. Professional experience must be post-baccalaureate and progressive in nature. Must have academic background or professional experience with: Enterprise-level UNIX system administration/engineering; Linux platforms; writing support documentation for Linux on x86-based software; system startup/shutdown mechanics; kickstart; grid computing RPMs; Perl, shell, C programming; Apache HTTPD, PHP, or MySQL; virtualization technologies: KVM, Xen or VMware; grid computing; package management (installation and building Resource Package Managers). May require 5-10% of domestic travel time.



**Apple** is looking for qualified individuals for following 40/hr/wk positions. To apply, mail your resume to 1 Infinite Loop, M/S: 104-1GM, Attn: LJ, Cupertino, CA 95014 with Req # and copy of ad. Job site & interview, Cupertino, CA Principals only. EOE.

**Siri Software Engineer [Req. #20704874]** Responsible for designing and implementing natural language interactions and work flow that provide for intelligent user assistance. Req.'s Bachelor's degree or foreign equivalent in Computer Science, or related degree plus five (5) years experience in job offered or related occupations. Professional experience must be post-baccalaureate progressive in nature. Must have professional experience with: development experience with server-side Java and web services; object-oriented programming and design skills; Writing multi-threaded code; persistence datastores (relational databases, NoSQL etc.) and data model/schema design; production-quality software release and testing.

**Software Engineer (2 Openings) [Req. #20529090]** Responsible for building first-class open source compiler tools and apply them in new and innovative ways. Req.'s Bachelor's degree, or foreign equivalent, in Computer Engineering, Computer Science, Electrical Engineering, Mathematics, or related field. Must have academic knowledge or professional experience with: high-level programming languages including C and C++ programming; compiler design and implementation; performance analysis; software testing; computer architecture; ability to understand and debug computer assembly code.

**Software Engineer [Req. #20528591]** Develop, extend, execute, and analyze regression. Provide functional, performance test plans and automation for networking components in iOS and Mac OS X. Req.'s Master's degree, or foreign equivalent, in Computer Science, or related field. One (1) year professional experience in job offered or in a related occupation. Must have academic background or professional experience with: trace route; tcpdump; network analyzers; coding in C, shell and/or python; modern networking protocols including: Transmission Control Protocol/Internet Protocol (TCP/IP), User Datagram Protocol (UDP), Network Address Translation (NAT) and Virtual Private Networks (VPN) protocols.

**ASIC Design Engineer (2 Openings) [Req. #20749988]** Work within a team that designs and implements various Apple chips. Requires Bachelor's degree, or foreign equivalent, in Electrical Engineering, Electronics and Communication Engineering, Computer Engineering, or related field plus five (5) years professional experience in job offered or in a related occupation. Professional experience must be post-baccalaureate and progressive in nature. Must have academic background or professional experience with: algorithms of static timing analysis of complex integrated circuit designs; hands-on experience with industry standard static timing analysis (STA) tool (Primetime suite including PT, PT-SI, PT-PX); scripting language with at least one of the following languages: Tcl, Perl, Python; hands on experience generating engineering change orders for fixing timing paths.

**Apple** is looking for qualified individuals for following 40/hr/wk positions. To apply, mail your resume to 1 Infinite Loop, M/S: 104-1GM, Attn: LJ, Cupertino, CA 95014 with Req # and copy of ad. Job site & interview, Cupertino, CA Principals only. EOE.

**Technical Program Manager [Req. #20750099]** Drive technical operational issues related to liquid crystal display (LCD) and final assembly processes, ensuring effective closure of technical issues and smooth process flow through the new product introduction cycle and mass production phase. Requires Bachelor's degree, or foreign equivalent, in Materials Science, Engineering, or related field plus five (5) years professional experience in job offered or in a related occupation. Professional experience must be post-baccalaureate progressive in nature. Must have professional experience with: LED and LCD display development and mass production; technical and manufacturing processes for mass production; LED and LCD display quality requirements and performance standards; quality assurance reviews; new LCD manufacturing process evaluation and setup; LCD process capability improvement. Requires up to 30% international travel.

**Software Integration Engineer [Req. #20750246]** Drive development and delivery of mission-critical graphics components for Apple's world-class computer products. Req's Bachelor's degree, or foreign equivalent, in Computer Science, Electrical Engineering, or related field. Five (5) years professional experience in job offered or in a related occupation. Professional experience must be post-baccalaureate and progressive in nature. Must have academic background or professional experience with: software development in computer graphics drivers or development on complex driver stack; technical leadership; management of cross-functional teams and external vendors; identification of potential solutions to complex technical issues; development of risk/benefit analysis for feature development options and introduction of late development changes into a program; communicating complex technical issues both verbally and written for consumption at all levels of management and engineering; management of multiple issues simultaneously and quickly adjusting to change in schedules and/or requirements for assigned programs.

**Software Engineer [Req. #19020790]** Responsible for understanding WiFi/BT CoExistence technology on a single antenna solution in 2.4GHz ISM band. Req.'s Master's degree or foreign equivalent in Electrical Engineering, Computer Science or related degree plus two (2) years experience in job offered or related occupations. Must have professional experience with: testing WLAN and/ or Bluetooth; understanding of WLAN and Bluetooth CoExistence; reading WLAN and Bluetooth traces; debugging and finding issues in CoExistence; in-depth understanding of OS X, Windows and/or Unix; owning a complete functional area of an application or product; understanding of SQA methodologies and practices.

**Web Application Developer [Req. #20981046]** Enhance our device management solutions and tools for Apple devices running iOS and OS X. Bachelor's degree, or foreign equivalent, in Computer Science, Electronic Engineering, or related field. Five (5) years professional experience in job offered or in a related occupation. Professional experience must be post-baccalaureate progressive in nature. Must have professional experience with: developing modern, event driven web applications using AJAX technologies; developing consumer oriented GUI applications; ey/value observing and binding; object oriented design and analysis skills; understanding of the full lifecycle development process including understanding business and functional requirements, developing detailed technical designs, and implementing testable solutions.

**Apple** is looking for qualified individuals for following 40/hr/wk positions. To apply, mail your resume to 1 Infinite Loop, M/S: 104-1GM, Attn: LJ, Cupertino, CA 95014 with Req # and copy of ad. Job site & interview, Cupertino, CA Principals only. EOE.

**Software Development Engineer [Req. #21053093]** Design and implement modular components of a distributed data processing and management infrastructure that spans multiple technologies. Requires Master's degree or foreign equivalent in Computer Engineering, Software Engineering, or related degree plus two (2) years experience in the job offered or in a related occupation. Must have academic background or experience with: Java Programming (design & architecture, algorithms); designing and implementing systems that collect, store and analyze many Terabytes of data using Hadoop; MapReduce, HDFS, Hive, HBase Or Cassandra, ZooKeeper; using serialization, compression codecs and file-based data structures (sequence file and map file); Python and Bash Scripting; high throughput and scaleable applications etc.; Oracle 10g, 11g databases.

**Senior Software Engineer [Req. #21058542]** Work on large-scale, server-side web applications using Java, MySQL and Oracle with the Structured Query Language (SQL), Extensible Markup Language (XML), HyperText Markup Language (HTML) and JavaScript Object Notation (JSON). Req.'s Bachelor's degree, or foreign equivalent, in Computer Science, Electronic Engineering, or related plus five (5) years professional experience in job offered or in a related occupation. Professional experience must be post-baccalaureate and progressive in nature. Must have academic background or professional experience with: Java; MySQL/Oracle; Markup Language (XML); JavaScript Object Notation (JSON); Apache SOLR; J2EE (Java 2 Enterprise Edition)/WebObjects.

**Lab Software Quality Assurance Engineer [Req. #21057893]** Responsible for executing cellular telephony tests protocol tests used for carrier acceptance such as those defined for AT&T. Requires Master's degree or foreign equivalent in Electrical Engineering or related field plus two (2) years of experience in the job offered or in a related occupation. Must have professional experience with: understanding of 3GPP (3rd generation partnership project) technologies such as UMTS and GSM. Familiar with RLC (Radio Link Control), MAC (Medium Access Control) and RRC (Radio Resource Control); testing cellular telephony features such as voice call flow, audio on voice calls, TTY, SMS(short message service), cellular packet data services, supplementary services and end-to-end signaling; AT&T Carrier Acceptance testing and IOT(Interoperability Testing).

**Engineering Project Planner [Req. #21103081]** Coordinate all engineering development activities (Electrical, mechanical, operational) related to the design, Hardware integration, testing, and implementation of new products in the Input Device space. Requires Master's degree, or foreign equivalent, in Electrical Engineering, Mechanical Engineering, Industrial Engineering, or related field plus two (2) years professional experience in job offered or in a related occupation. Must have academic or professional experience with: the full life cycle of new product development from concept through production release; developing and driving daily and weekly project schedules; developing and executing presentations regarding project to upper management; consumer electronic product manufacturing processes; remotely communicating project plans and to managing activities of 3rd party overseas suppliers. 20% international travel required.

**Apple** is looking for qualified individuals for following 40/hr/wk positions. To apply, mail your resume to 1 Infinite Loop, M/S: 104-1GM, Attn: LJ, Cupertino, CA 95014 with Req # and copy of ad. Job site & interview, Cupertino, CA Principals only. EOE.

**System Design Engineer [Req. #21106087]** Work on radiated performance of wireless portable devices. Requires Master's degree, or foreign equivalent, in Electrical Engineering, Electronics Engineering, Telecommunication, or related field plus one (1) year professional experience in job offered or in a related occupation. Must have professional experience with: RF characteristics and requirements for modern wireless communication systems such as GSM/GPRS/EDGE, 802.11, Bluetooth, including the corresponding system level specifications (e.g. ETSI 51.010, 51.05); radiation performance, antenna and wave propagation; regulatory requirements and process for wireless consumer devices, including FCC, PTCRB, CTIA, ETSI, TIA/EIA; programming skills in C, C++. May have direct reports. Requires up to 10% domestic travel.

**Software Engineer [Req. # 21106235]** Build rich media advertising content and software using Apple's mobile operating system, iOS, and Apple's iAd Platform technologies. Requires Bachelor's degree, or foreign equivalent, in Information Technology, Computer Science, Software Engineering, Engineering, Mathematics, Graphic Design, Media Arts and Sciences, or related field plus two (2) years professional experience in job offered or in a related occupation. Must have academic background or professional experience with: object-oriented design and programming; constructing rich media ad units including elements of video, audio, and producing Visual Assets using Adobe Photoshop and Illustrator; programming with JavaScript; programming with Hypertext Markup.

**ASIC Design Engineer [Req. #21106290]** Perform Verilog coding, modeling, simulation and debug. Requires Master's degree, or foreign equivalent, in Electrical Engineering, Computer Science or Engineering, or related field plus two (2) years experience in the job offered or in any related occupation. Must have academic background or professional experience with: Computer architecture; languages (Verilog or VHDL); Scripting and/or programming languages (awk, perl, python, C/C++); EDA design tools – synthesis, simulation, timing analysis, place and route; logic/circuit design.

**Audio Electrical Engineer [Req. #21225782]** Responsible for Development of prototypes to evaluate new designs. Req.'s Bachelor's degree, or foreign equivalent, in Electrical Engineering or related plus five (5) years professional experience in job offered or in a related occupation. Professional experience must be post-baccalaureate and progressive in nature. Must have academic background or professional experience with: Audio codec's, amplifiers, speakers and microphones; Audio test equipment (Audio Precision); Schematic Drawing; Board Layout.

**Apple** is looking for qualified individuals for following 40/hr/wk positions. To apply, mail your resume to 1 Infinite Loop, M/S: 104-1GM, Attn: LJ, Cupertino, CA 95014 with Req # and copy of ad. Job site & interview, Cupertino, CA Principals only. EOE.

**Software Engineer [Req. #21106011]** Develop OpenCL framework for CPUs and GPUs in Mac OS X including the OpenCL runtime APIs and OpenCL language built-in functions. Req's Master's degree, or foreign equivalent, in Computer Science, or related field. Five (5) years professional experience in job offered or in a related occupation. Must have academic background or professional experience with: programming languages including C, C++; GPU architecture, CPU vector ISAs such as Intel SSE and AVX; parallel programming and performance tuning of parallel algorithms for CPUs and/or GPUs; software design, problem solving and debugging skills; OpenCL.

**System Design Engineer [Req. #21310162]** Evaluate the latest iPad, iPhone and iPod HW systems in the field. Perform very early evaluations of Prototypes and HW Systems on different wireless technologies. Requires Master's degree or foreign equivalent in Computer Science, Electrical Engineering, System Engineering or related field. Must have academic background or professional experience with: C, C++, Python and Matlab; Communication systems, spread spectrum and communications theory; & RF Background in UMTS/HSPA C2K/EVDO. May have direct reports. Travel required approximately 50% of time.

**Sr. Software Engineer/Tech Lead [Req. #21483719]** Provide design, development and cross functional interaction across multiple projects. Requires Master's degree, or foreign equivalent, in Marketing, Engineering, Computer Science or related degree and six (6) years experience in the job offered or in a related position. In the alternative, will accept a Bachelor's degree, or foreign equivalent and eight (8) years of post-baccalaureate progressive experience. Must have professional experience with: application development and design; variety of development tools and languages, such as Java/J2EE, JSP, Spring, Hibernate, Tomcat / WebSphere / JBoss, HTML; Oracle and performance tuning; Eclipse, XML, JSON, SVN, Maven, UML, design patterns; development in Linux environment; Object Oriented design and analysis skills; developing server side software using Java; working in a team environment; technical documentation.



Applied Materials, Inc. is accepting resumes for the following positions in **Santa Clara/Sunnyvale, CA:**

**Senior GIS Service Management Analyst (SCSTA):** Analyzes functional requirements and recommends technical solution to stakeholders. Manages the lifecycle of IT services recommending patching, point releases and major upgrades.

**Account Technologist (SCHSU):** Designing, performing, collecting data, analyzing, and compiling reports on difficult process engineering experiments within safety guidelines. Position may be assigned to work at unanticipated international worksites as determined by headquarters (50%).

**Process Support Engineer (SCAKA):** Executes Process Engineering projects to qualify or improve the process performance of company's products. Position may be assigned to work at unanticipated worksites throughout the US as determined by headquarters (10%).

Please mail resumes with reference number to Applied Materials, Inc., 3225 Oakmead Village Drive, M/S 1217, Santa Clara, CA 95054. No phone calls please. Must be legally authorized to work in the U.S. without sponsorship. EOE.

[www.appliedmaterials.com](http://www.appliedmaterials.com)

## RadiumOne, Inc.

has the following  
job opportunity available in  
**San Francisco, CA:**

### Lead Software Developer

Develop front-end components of the system based on J2SE and J2EE technologies that provide internal and external users with features and functionality to manage advertising campaigns, monitor their performance, provide reporting and allow targeting and optimization of campaigns.

Submit resume by mail to: Attn: HR Services, RadiumOne, Inc., 55 Second Street, 18th Floor, San Francisco, CA 94105. Must reference job code AG103.

## ADVERTISER SALES INFORMATION • NOVEMBER 2012

### Advertising Personnel

Marian Anderson  
Sr. Advertising Coordinator  
Email: [manderson@computer.org](mailto:manderson@computer.org)  
Phone: +1 714 816 2139  
Fax: +1 714 821 4010

Sandy Brown  
Sr. Business Development Mgr.  
Email: [sbrown@computer.org](mailto:sbrown@computer.org)  
Phone: +1 714 816 2144  
Fax: +1 714 821 4010

### Advertising Sales Representatives (display)

Central, Northwest, Far East:  
Eric Kincaid  
Email: [e.kincaid@computer.org](mailto:e.kincaid@computer.org)  
Phone: +1 214 673 3742  
Fax: +1 888 886 8599

Northeast, Midwest, Europe,  
Middle East:  
Ann & David Schissler  
Email: [a.schissler@computer.org](mailto:a.schissler@computer.org),  
[d.schissler@computer.org](mailto:d.schissler@computer.org)  
Phone: +1 508 394 4026  
Fax: +1 508 394 1707

Southwest, California:  
Mike Hughes  
Email: [mikehughes@computer.org](mailto:mikehughes@computer.org)  
Phone: +1 805 529 6790

Southeast:  
Heather Buonadies  
Email: [h.buonadies@computer.org](mailto:h.buonadies@computer.org)  
Phone: +1 973 585 7070  
Fax: +1 973 585 7071

### Advertising Sales Representative (Classified Line)

Heather Buonadies  
Email: [h.buonadies@computer.org](mailto:h.buonadies@computer.org)  
Phone: +1 973 585 7070  
Fax: +1 973 585 7071

### Advertising Sales Representative (Jobs Board)

Heather Buonadies  
Email: [h.buonadies@computer.org](mailto:h.buonadies@computer.org)  
Phone: +1 973 585 7070  
Fax: +1 973 585 7071

**It's work that matters. It's what we do at Symantec.** Symantec is the world leader in providing solutions to help individuals and enterprises assure the security, availability, and integrity of their information. In essence, we protect the free flow of information in a connected world. As the fourth largest independent software company in the world, Symantec has operations in more than 40 countries with 475 out of Fortune's global 500 companies using our solutions.

People look to us to safeguard the integrity of their information, ensuring it is secure and available. Achieving this ambitious goal is only possible through the combined efforts of the innovators and visionaries that Symantec continuously attracts. Symantec draws the very best people with a variety of backgrounds, experiences and perspectives and provides them with a work environment where uniqueness is valued and empowered. The creative people we attract help define the spirit of innovation at Symantec. Symantec is proud to be an equal opportunity employer.

We currently have openings for the following positions (various levels/types):

#### **Bellevue, WA**

**Software Engineers: (Job ID #SWEWA1012)** Responsible for analyzing, designing, debugging and/or modifying software; or evaluating, developing, modifying, and coding software programs to support programming needs

#### **Culver City, CA**

**Software Engineers: (Job ID #SWECC1012)** Responsible for analyzing, designing, debugging and/or modifying software; or evaluating, developing, modifying, and coding software programs to support programming needs.

**Software QA Engineers: (Job ID #SQACC1012)** Responsible for developing, applying and maintaining quality standards for company products. Develop and execute software test plans. Analyze and write test standards and procedures.

**Engineering Managers: (Job ID #EMCC1012)** Direct and supervise team of engineers (QA and/or development teams); Develop standards for products and/or oversee development and execution of software and/or analysis of test results.

**Sr. Manager, Development (Job ID #DEVCC1012)** Responsible for working with development team to produce functional specification, architectural documents and engineering plans for software products. Responsible for technical development and management of multiple teams for complex projects.

#### **Heathrow, FL**

**Software Engineers: (Job ID #SWEFL1012)** Responsible for analyzing, designing, debugging and/or modifying software; or evaluating, developing, modifying, and coding software programs to support programming needs.

Submit resume to [JOBADS@symantec.com](mailto:JOBADS@symantec.com) . Must reference position & Job ID# listed above. EOE. For additional information about Symantec and other positions visit our website at <http://www.symantec.com>.



**It's work that matters. It's what we do at Symantec.** Symantec is the world leader in providing solutions to help individuals and enterprises assure the security, availability, and integrity of their information. In essence, we protect the free flow of information in a connected world. As the fourth largest independent software company in the world, Symantec has operations in more than 40 countries with 475 out of Fortune's global 500 companies using our solutions.

People look to us to safeguard the integrity of their information, ensuring it is secure and available. Achieving this ambitious goal is only possible through the combined efforts of the innovators and visionaries that Symantec continuously attracts. Symantec draws the very best people with a variety of backgrounds, experiences and perspectives and provides them with a work environment where uniqueness is valued and empowered. The creative people we attract help define the spirit of innovation at Symantec. Symantec is proud to be an equal opportunity employer.

We currently have openings for the following positions (various levels/types):

#### Mountain View, CA

**Analytics Manager (Business Intelligence) (Job ID #AMHQ1012)** Analyze science, engineering, business and/or other business intelligence issues for application to Symantec solutions and/or provide operational support in the development and implementation process of computer software applications, systems or services.

**Computer Systems Analysts (Job ID# CSAHQ1012)** Analyze science, engineering, business and/or other business intelligence issues for application to Symantec solutions; and/or provide operational support in the development and implementation process of computer software applications, systems or services.

**IT Infrastructure Specialist (Job ID# ITSHQ1012)** Manage large complex infrastructure environments by designing, planning, and implementing complex infrastructure systems. Establish and recommend policies and standards on system use and services and automate monitoring or periodic preventative maintenance processes.

**Software Engineers (Job ID #SWEHQ1012)** Responsible for analyzing, designing, debugging and/or modifying software; or evaluating, developing, modifying, and coding software programs to support programming needs.

**Software QA Engineers (Job ID #SQAHQ1012)** Responsible for developing, applying and maintaining quality standards for company products. Develop and execute software test plans. Analyze and write test standards and procedures.

**Software Engineer (Fraud Detection) (Job ID #1648.1280)** Responsible for evaluating, developing, modifying and/or coding software programs to support programming needs. Part of Fraud Detection Service Team that researches and investigates fraudulent activity, specifically related to misuse and abuse of financial applications.

**Director, Information Security (Job ID #DISHQ1012)** Responsible for all aspects of Information Security. Manage Secure Business Integration function. Oversee network of specialized security professionals participating in the Information System Security Officer program; drive balanced security controls into business infrastructure and processes to safeguard the company's assets and intellectual property.

**Engineering Managers (Job ID# EMHQ1012)** Direct and supervise team of engineers (QA and/or development teams); Develop standards for products and/or oversee development and execution of software and/or analysis of test results.

**Financial Programmer Analysts (Job ID# FPAHQ1012)** Provide technical support and administer departmental financial reporting and other department servers and databases; and/or analyze engineering, business and all other data processing problems for application to electronic data processing systems.

**Product Managers (Job ID# PDMHQ1012)** Serve as technical advisor for product operation matters and customer needs. Provide technical details during creation of new products to portray feature needs to engineering and/or other departments.

**Sr. Manager, Technical Support (Job ID #MTSHQ1012)** Manage a functional or technical customer support group, including developing work plans and establishing the technical direction of the technical support department. Administer technical support programs and develop and recommend new programs. Must be available to travel to various, unanticipated sites throughout the U.S. May telecommute from home.

**Technical Support Engineers (Job ID #TSEHQ1012)** Provide technical assistance and support to internal and/or external computer systems users and clients. Must be available to travel to various unanticipated sites in the U.S.

Submit resume to [JOBADS@symantec.com](mailto:JOBADS@symantec.com). Must reference position & Job ID# listed above. EOE. For additional information about Symantec and other positions visit our website at <http://www.symantec.com>.





**It's work that matters. It's what we do at Symantec.** Symantec is the world leader in providing solutions to help individuals and enterprises assure the security, availability, and integrity of their information. In essence, we protect the free flow of information in a connected world. As the fourth largest independent software company in the world, Symantec has operations in more than 40 countries with 475 out of Fortune's global 500 companies using our solutions.

People look to us to safeguard the integrity of their information, ensuring it is secure and available. Achieving this ambitious goal is only possible through the combined efforts of the innovators and visionaries that Symantec continuously attracts. Symantec draws the very best people with a variety of backgrounds, experiences and perspectives and provides them with a work environment where uniqueness is valued and empowered. The creative people we attract help define the spirit of innovation at Symantec. Symantec is proud to be an equal opportunity employer.

We currently have openings for the following positions (various levels/types):

#### Herndon, VA

**Engineering Managers: (Job ID #EMVA1012)** Direct and supervise team of engineers (QA and/or development teams); Develop standards for products and/or oversee development and execution of software and/or analysis of test results.

#### Lindon, UT

**Technical Support Engineers: (Job ID #TSEUT1012)** Provide technical assistance and support to internal and/or external computer systems users and clients. Provide level 3 support to customers with issues on assigned product (Symantec Endpoint Management Products).

#### Roseville, MN

**Software Engineers: (Job ID #SWEMN1012)** Responsible for analyzing, designing, debugging and/or modifying software; or evaluating, developing, modifying, and coding software programs to support programming needs.

#### San Francisco, CA

**Software Engineers: (Job ID #SWESF1012)** Responsible for analyzing, designing, debugging and/or modifying software; or evaluating, developing, modifying, and coding software programs to support programming needs.

**Software QA Engineers: (Job ID #SQASF1012)** Responsible for developing, applying and maintaining quality standards for company products. Develop and execute software test plans. Analyze and write test standards and procedures.

**Engineering Managers (Job ID# EMSF1012)** Direct and supervise team of engineering (QA and/or development teams). Develop standards for products and/or oversee development and execution of software and/or analysis of test results.

**Manager, Development (Job ID# DEVSF1012)** Manage Anti-Spam Core Development Team. Design and architect solution to share the Anti-Spam code base across Symantec products. Design and architect solution to share the Anti-Spam code base across Symantec products.

**Technical Directors (Job ID# TDSF1012)** Define and drive the strategic direction of technology for business and products. Research product prototypes and investigate new technologies. Review and drive continuous improvement in products, infrastructure and development practices. Define architecture and product specifications, and determine new product life cycles.

Submit resume to [JOBADS@symantec.com](mailto:JOBADS@symantec.com). Must reference position & Job ID# listed above. EOE. For additional information about Symantec and other positions visit our website at <http://www.symantec.com>.



## FORWARD SLASH

# Love the Show!

David Alan Grier and Erin Dian Dumbacher

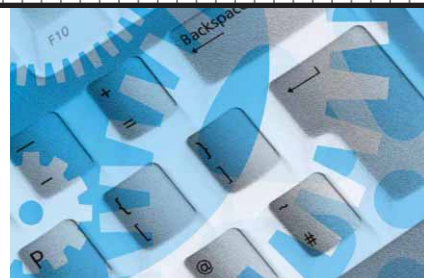

AUDIO

**There are some problems that engineered approaches can't solve, and building a reputation—a problem of marketing and people—is one of them.**

**W**hat part of building engineering's reputation is accomplishment, and what part is theatrics?

**//DAG//** The other end of the table was the first to recognize the television host in the restaurant. One moment, we were a group of technologists talking about predictive analytics and Bayesian nets, and the next, we were giddy fans who were enthused by a celebrity in our midst. "Rock star!" shouted Ahmed. Serge added, "Love the show!"

But the moment quickly passed. The celebrity nodded his head to acknowledge our attention and then left the restaurant with his entourage. We returned to our conversation. The benefits of a brush with fame, if there were any to be had, didn't linger with us.

Time and again, I receive suggestions about how we might make software engineering more appealing to the youth of today, all of which are well intentioned. They're offered by people who are honestly concerned about the field's future. Many of them suggest that we should promote a young engineer, a rock star of the technological work. In the process, they overlook that such a strategy requires the potential rock star to have the skills required to identify, build, and hold mass market appeal.

**//EDD//** Brace yourself for what you're about to read: there are some problems that engineered approaches

can't solve, and building a reputation—a problem of marketing and people—is one of them. Most of us learned the lesson in high school that hard work plus talent doesn't always equal popularity.

A confession: I was one of those annoying, backward-walking campus tour guides at my university. I talked about class size and residence halls, student life, and professors. My job was to sell the school, but those who trained me told me to also focus on my own experiences. If I piqued the interest of a prospective student with a story from my internship or a fun night out with friends on campus, the potential student might be more likely to listen to the "boring" application requirements. All I had to do was talk about my experiences, one carefully crafted anecdote at a time.

The problem for engineering is one of communication, not of reputation. People appreciate engineering accomplishments, they just don't always know about them. The recent, risky landing of a massive rover on Mars, for example, was the talk of both blogs and mainstream news cycles. It even had its own rock star, a NASA JPL program manager with a Mohawk hairdo.

**//DAG//** Engineers might not fit naturally into the world of mass popularity: to appeal to a mass market, you need to study that market, learn the aspirations of the group, and test ideas to engage those aspirations. If you (or your manager) don't spend

time trying to engineer your ideas for the crowd, you're relying on nothing more than the luck of the draw.

I had a few friends who tried to make a career in popular music. All of them quickly learned the lesson that they needed talents beyond the ability to sing well, look good in spandex, or write a compelling lyric. None really mastered the skill of rock stardom, though the most innovative of my friends, Danny, got his picture on a national magazine cover and was popular in four or five major college towns. When he finally concluded that he wasn't going to become a true rock star, he was more relieved than sad. He remarked that he would no longer have to force his body into jeans that were too tight or press his music into ears that wanted to hear something else.

At the restaurant, our group wasn't that interested in the power of celebrity. None seemed very interested in building mass recognition. All had moved onto new projects. "We work with technology," said one, "and we do it very well." **■**

*David Alan Grier is an IEEE Fellow and author of the forthcoming book *The Company We Keep*. Contact him at [grier@gwu.edu](mailto:grier@gwu.edu) or on Twitter @dagrier.*

*Erin Dian Dumbacher is a research director and consultant in Washington, DC. You can reach her at [erin.dumbacher@fulbrightmail.org](mailto:erin.dumbacher@fulbrightmail.org) or follow her on Twitter @erin\_dian.*

# Now... 2 Ways to Access the IEEE Member Digital Library

With two great options designed to meet the needs—and budget—of every member, the IEEE Member Digital Library provides full-text access to any IEEE journal article or conference paper in the IEEE *Xplore*® digital library.

Simply choose the subscription that's right for you:

## IEEE Member Digital Library

Designed for the power researcher who needs a more robust plan. Access all the IEEE content you need to explore ideas and develop better technology.

- 25 article downloads every month

## IEEE Member Digital Library Basic

Created for members who want to stay up-to-date with current research. Access IEEE content and rollover unused downloads for 12 months.

- 3 new article downloads every month

Get the latest technology research.

**Try the IEEE Member Digital Library—FREE!**

[www.ieee.org/go/trymdl](http://www.ieee.org/go/trymdl)



IEEE Member Digital Library is an exclusive subscription available only to active IEEE members.

# Design, Develop, Accelerate!

## Microway's Cutting Edge Platforms: Ready for Intel® Xeon Phi™ Coprocessors and NVIDIA® Tesla K20 GPUs

### WhisperStation™ – Quiet HPC at Your Desk

- ▶ 1 to 4 NVIDIA Tesla K20 or Quadro GPUs
- ▶ NVIDIA Quadro® GPUs for visualization + NVIDIA Tesla GPUs for lightning-fast computation
- ▶ Up to 32 x86 Cores and 512GB Memory
- ▶ High clock speed Intel® CPUs; SSDs and/or RAID for fast I/O; up to 8 drives; PCI-E Generation 3.0
- ▶ 80 PLUS™ certified power supplies, ultra-quiet fans, sound proofing materials and high-efficiency components

Increase performance with CUDA C/C++, PGI CUDA FORTRAN, or these GPU-enabled applications:

Design	Simulation	BioTech	
3ds Max	ANSYS CFD (Fluent)	MATLAB	AMBER
Adobe CS6	ANSYS Mechanical	ACUSIM AcuSolve	GROMACS
SolidWorks	Autodesk Moldflow	Tech-X GPUlib	NAMD
Bunkspeed Shot	Abaqus	Seismic City RTM	VMD
	SIMULIA®	VoxelGeo	TeraChem

### Scalable, Fully Integrated Clusters

- ▶ Designed with Dense 1U/2U Servers and PCI-E Generation 3.0
  - ▶ 8-core Xeon E5-2600 Series CPUs, DDR3-1600 Memory
  - ▶ NVIDIA Tesla K10, K20 or M2090 GPUs
  - ▶ Ready for Intel® Xeon Phi™ Coprocessors
  - ▶ Mellanox ConnectX-3 FDR InfiniBand
- Benchmark Remotely on 8 Xeon E5-2600s and 4 Tesla K20s.

### Microway Puts YOU on the Cutting Edge

Design your next custom configuration with techs who speak HPC. Rely on our integration expertise for complete and thorough testing of your workstations, turnkey clusters and servers. Whether you require Linux or Windows, CUDA® or OpenCL, Tesla K20 or Intel Xeon Phi we've been resolving the complicated issues – so you don't have to – since 1982.

### Get the Best Performance, Call Us First!

**508-746-7341 or [microway.com](http://microway.com)**

Sign up for technical newsletters at [microway.com/newsletter](http://microway.com/newsletter)

Read our blog at [microway.com/hpc-tech-tips](http://microway.com/hpc-tech-tips)

**Visit Microway at SC12  
Salt Lake City – Booth 2500**



GSA Schedule  
Contract Number:  
GS-35F-0431N



**Microway**  
Technology you can count on since 1982

All trademarks and logos are property of their respective owners.