

**Abstract** The future trends in nanoelectronics products are to be 'smaller', 'faster' and 'more complex'. This requires the characterization of materials on the nano length scales and at fast time scales. One of the tools for investigation is the X-rays produced at synchrotron at the Advanced Photon Source (APS). A wide range of X-ray techniques for characterization of materials at the nanoscale are available at the APS.

X-ray micro/nano beams are an emerging characterization tool with broad implications for nanoelectronics (1). These submicrometer hard x-ray beams with the ability to penetrate tens to hundreds of micrometers into most materials and with the ability to determine local composition, chemistry, and (crystal) structure can characterize buried sample volumes in small samples. Besides directly imaging nanostructures, the high brilliance and continuous tunability of synchrotron radiation also allows high-resolution images to be acquired at close energy intervals to produce an "energy scan." Such spectral imaging techniques provide a unique means of mapping the elemental composition of samples as well as certain chemical bonding states (XAFS Spectroscopy) (2).

1. G. E. Ice, J. D. Budai, J. W. L. Pang, *Science*, **334** 1234-1239 (2011).
2. Y. Wang, *Characterization of Materials*, edited by Elton N. Kaufmann. Copyright John Wiley & Sons, Inc., 2012, pp.1-10.

Spectroscopic x-ray techniques, for example, can be applied to extract element specific information about the magnetic, charge, and orbital character of a device. By varying the detection scheme such information can be obtained from a particular structural layer within a device or isolate the contributions arising solely at the interface between layers. The high x-ray flux provided by such facilities enables such measurements from sample volumes substantially less than one atomic layer. Further, the pulsed nature of synchrotron radiation enables pump-probe studies to observe the dynamics of such phenomena using optical or magnetic excitation on times scales down to ~100ps. X-ray diffraction measurements, on the other hand, can be used to understand the atomic structure at interfaces in complex heterostructured materials. Not only can these measurements be performed on static devices, but can also be applied in-situ during growth of a material to optimize these processes. As such synchrotron techniques can be used to provide valuable information on such disparate systems such as magnetic heterostructures and recording media, ferroelectric and/or multiferroic devices, and interfaces in semiconductors. Here, a few selective examples from diffraction, spectroscopy and imaging are highlighted.

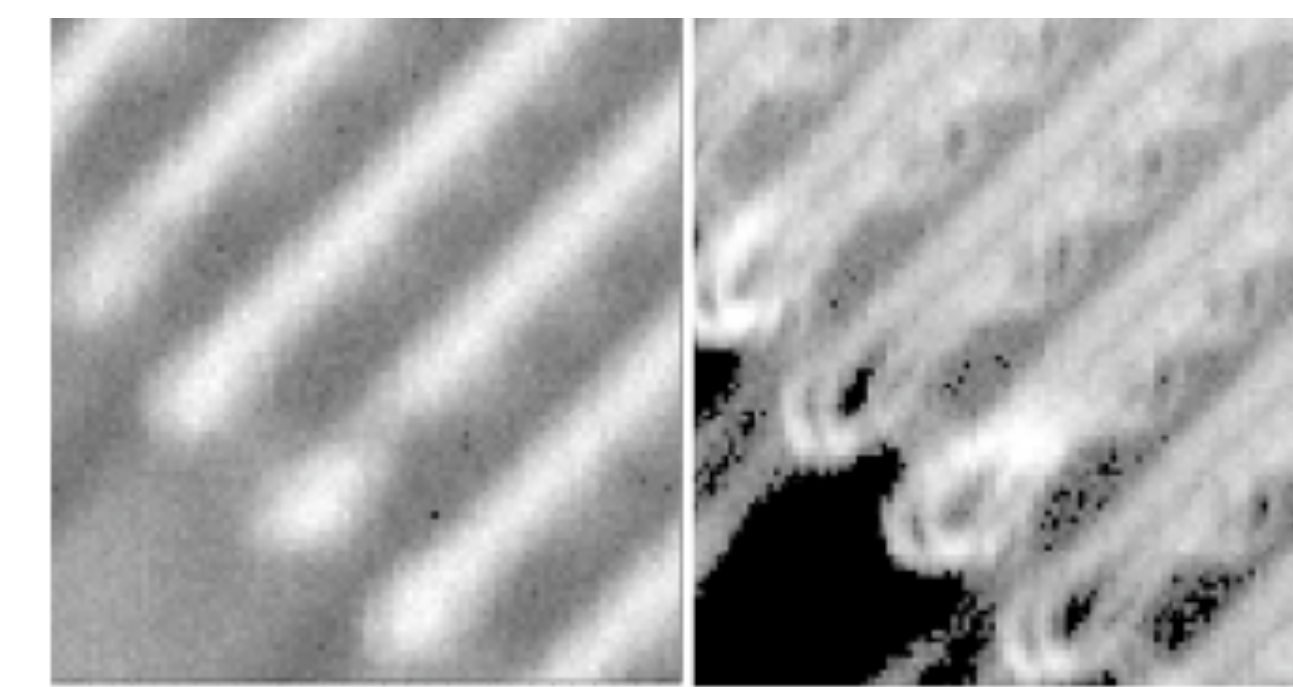
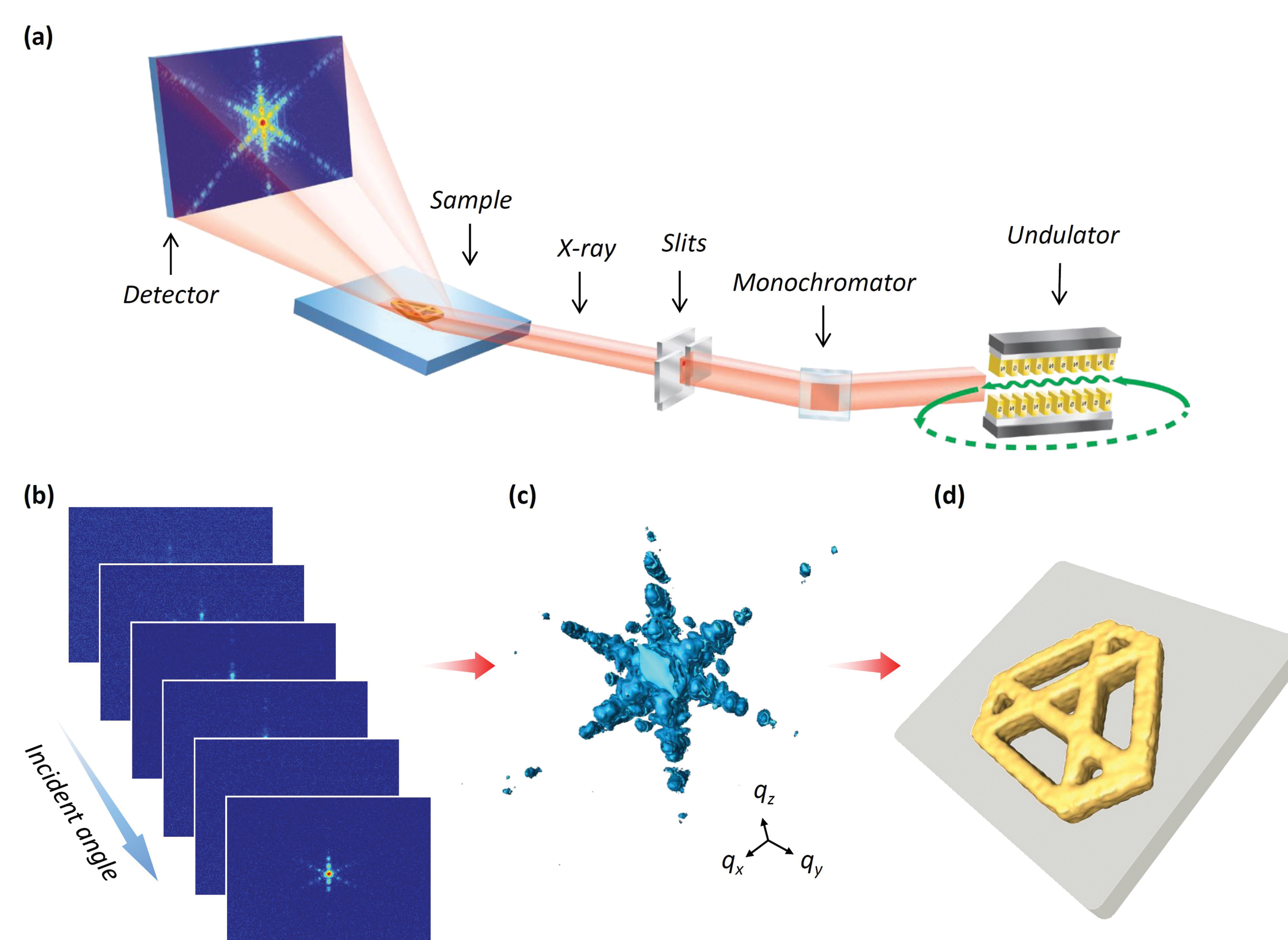

An integrated circuit imaged at 2-ID-B beamline at Advanced Photon Source, Argonne National Laboratory from reference 2 (present resolution 17nm).

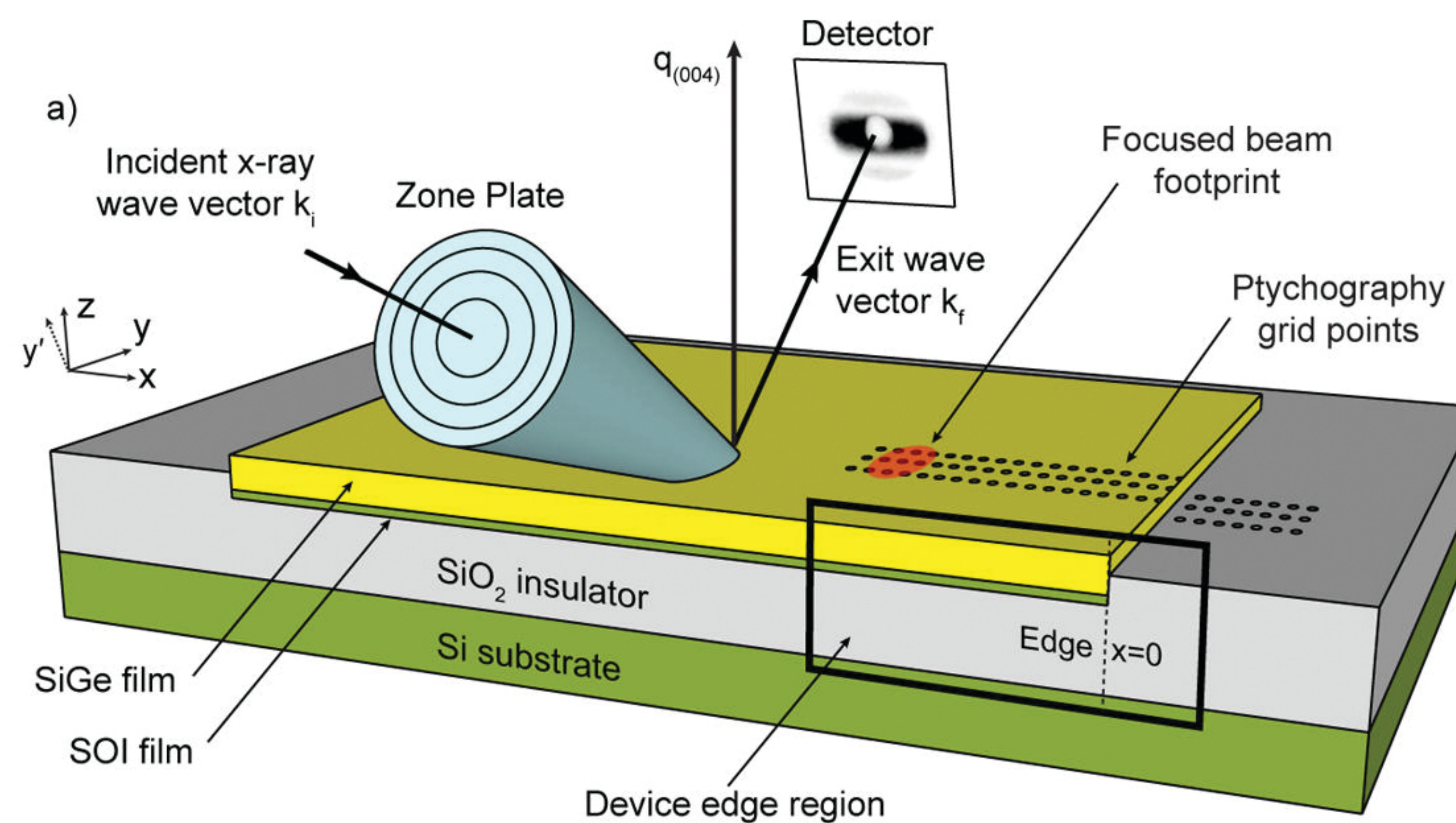

Nanofocused x-ray Bragg projection ptychography. Understanding strain in nanoscale semiconductors.

S.O. Hruszkewycz et al

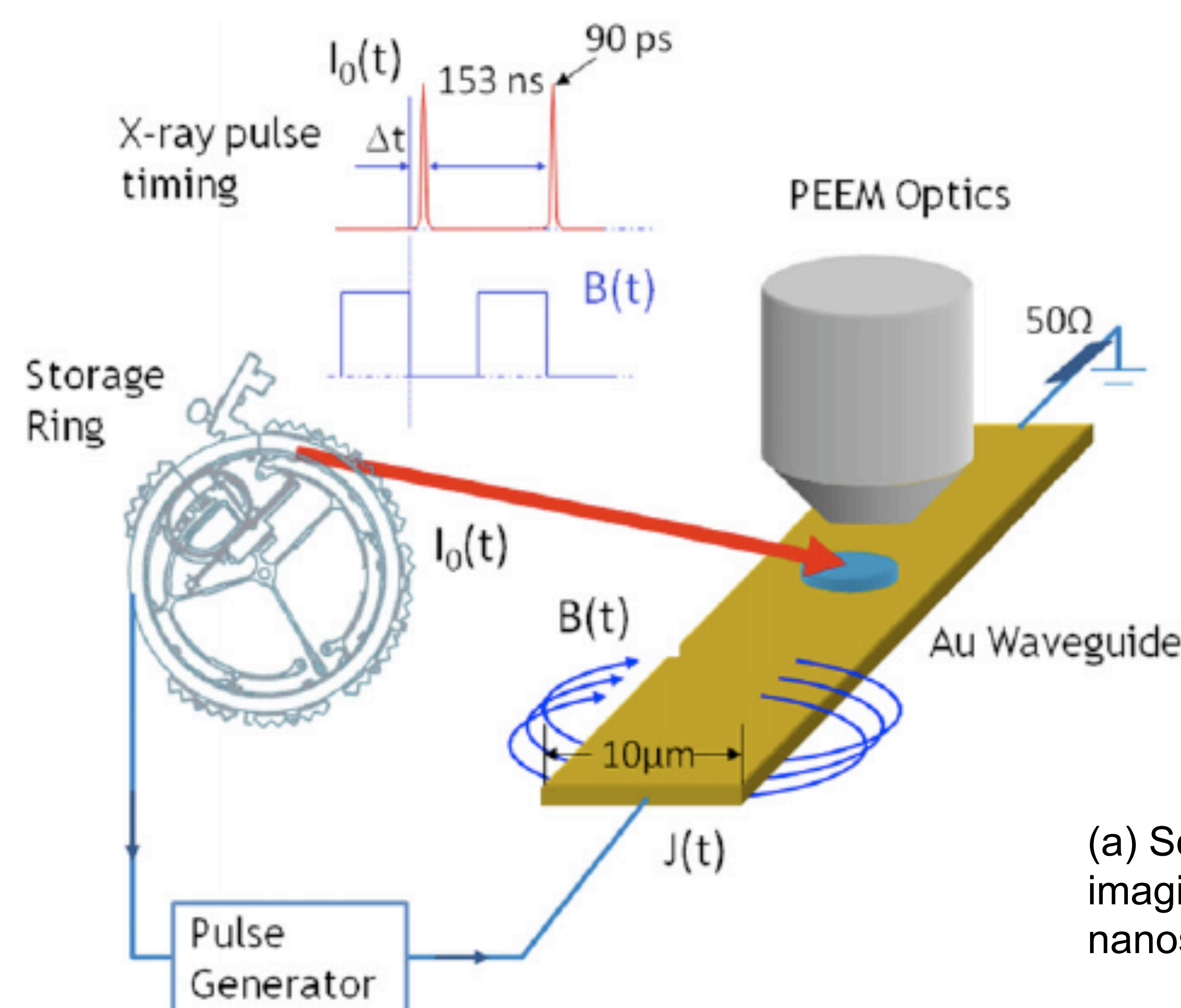

Imaging Stress, Strain, and Tension in the Nanoworld

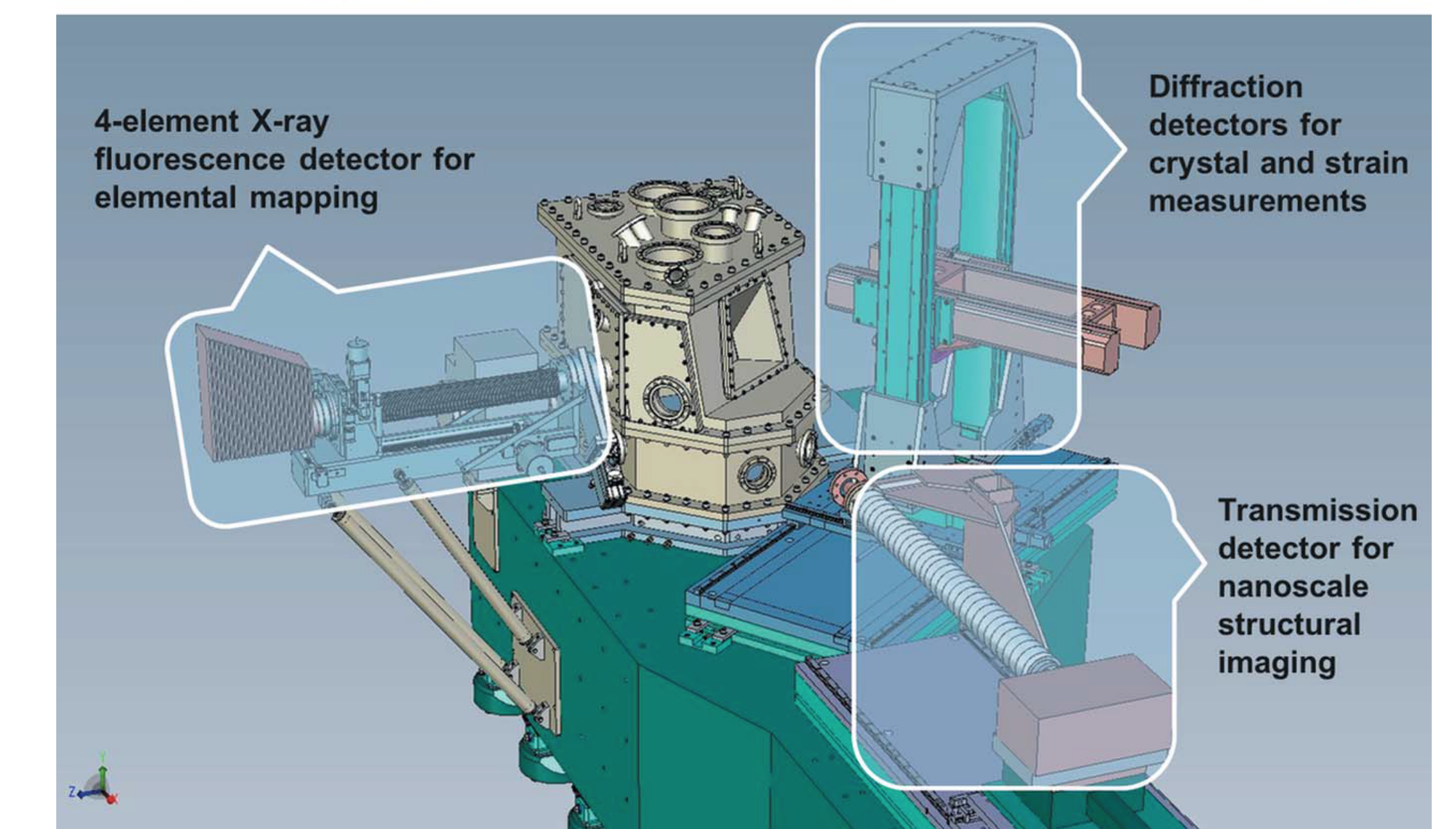
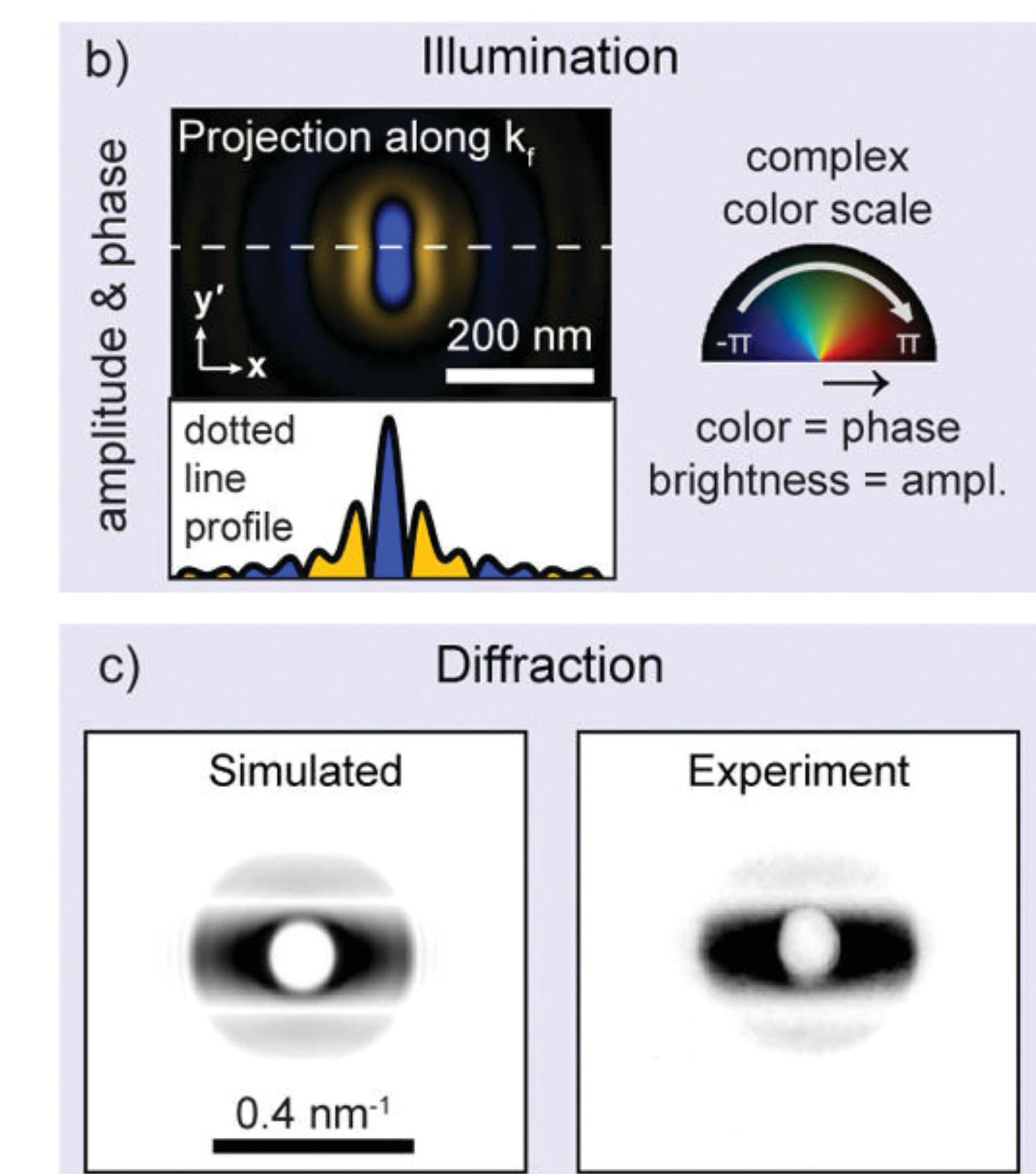
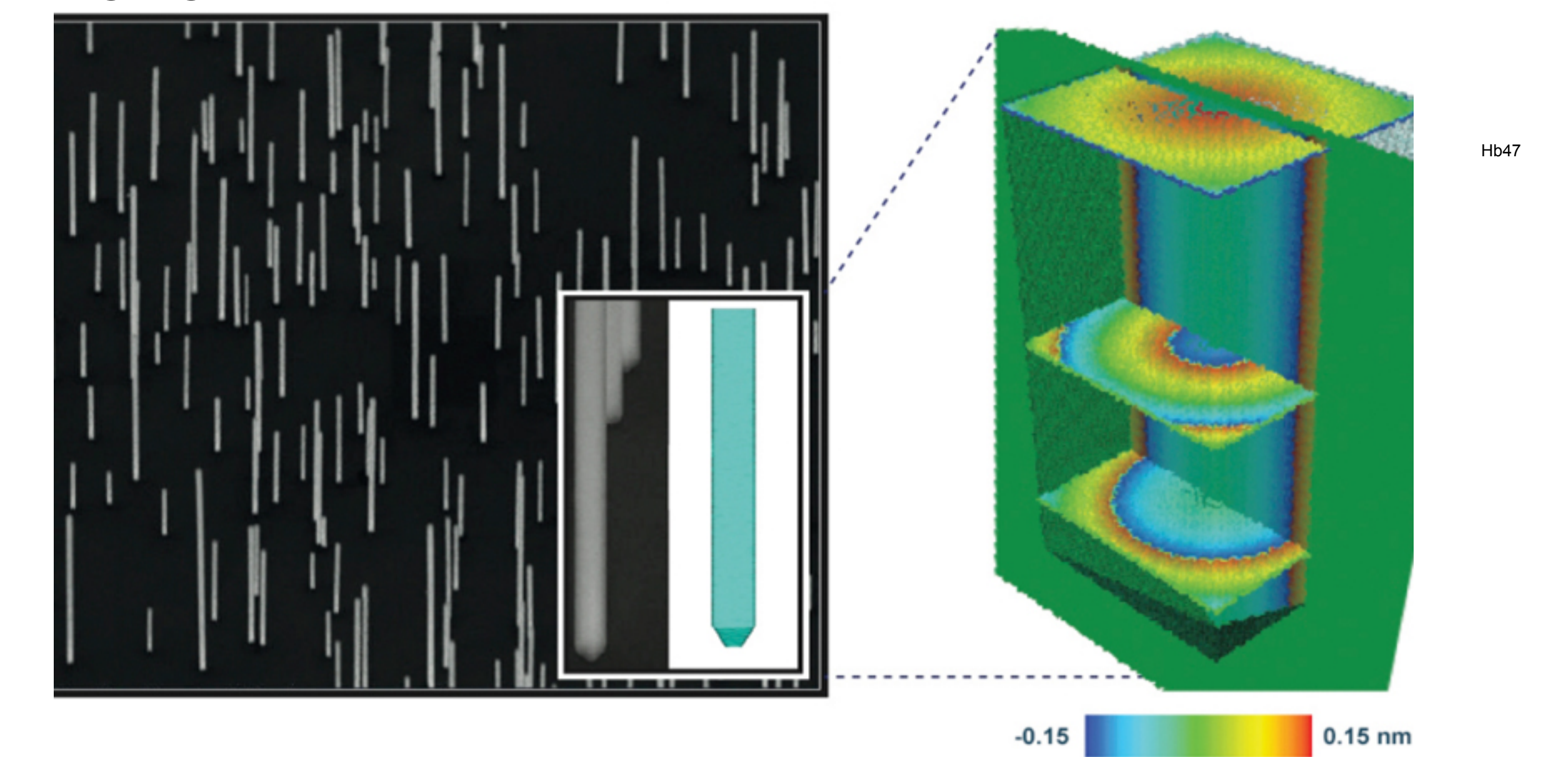

Schematic drawing of the Hard X-ray Nanoprobe showing the three detection modes used for nanoscale imaging.

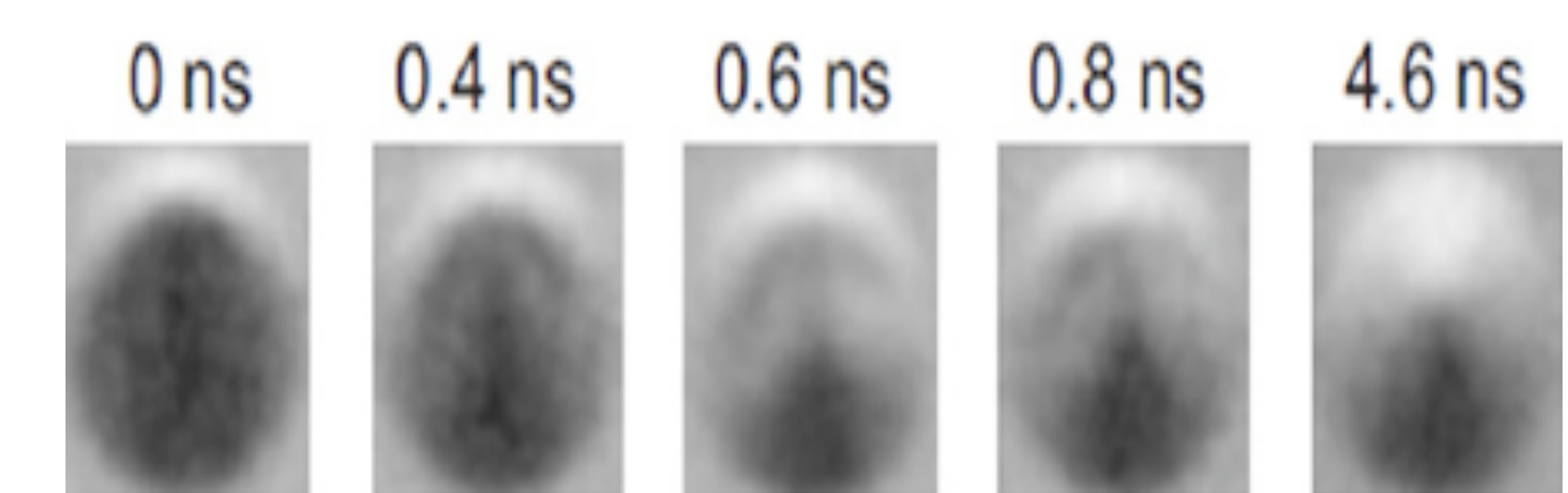

(a) Schematic diagram of a pump-probe time-resolved magnetic imaging experiment (b) Transient domain states observed in nanostructures at the APS (11).