

NBS MONOGRAPH 39

**Calibration Procedures for
Direct-Current Resistance Apparatus**



**U.S. DEPARTMENT OF COMMERCE
NATIONAL BUREAU OF STANDARDS**

THE NATIONAL BUREAU OF STANDARDS

Functions and Activities

The functions of the National Bureau of Standards are set forth in the Act of Congress, March 3, 1901, as amended by Congress in Public Law 619, 1950. These include the development and maintenance of the national standards of measurement and the provision of means and methods for making measurements consistent with these standards; the determination of physical constants and properties of materials; the development of methods and instruments for testing materials, devices, and structures; advisory services to government agencies on scientific and technical problems; invention and development of devices to serve special needs of the Government; and the development of standard practices, codes, and specifications. The work includes basic and applied research, development, engineering, instrumentation, testing, evaluation, calibration services, and various consultation and information services. Research projects are also performed for other government agencies when the work relates to and supplements the basic program of the Bureau or when the Bureau's unique competence is required. The scope of activities is suggested by the listing of divisions and sections on the inside of the back cover.

Publications

The results of the Bureau's research are published either in the Bureau's own series of publications or in the journals of professional and scientific societies. The Bureau itself publishes three periodicals available from the Government Printing Office: The Journal of Research, published in four separate sections, presents complete scientific and technical papers; the Technical News Bulletin presents summary and preliminary reports on work in progress; and Basic Radio Propagation Predictions provides data for determining the best frequencies to use for radio communications throughout the world. There are also five series of nonperiodical publications: Monographs, Applied Mathematics Series, Handbooks, Miscellaneous Publications, and Technical Notes.

A complete listing of the Bureau's publications can be found in National Bureau of Standards Circular 460, Publications of the National Bureau of Standards, 1901 to June 1947 (\$1.25), and the Supplement to National Bureau of Standards Circular 460, July 1947 to June 1957 (\$1.25), and Miscellaneous Publication 240, July 1957 to June 1960 (Includes Titles of Papers Published in Outside Journals 1950 to 1959) (\$2.25); available from the Superintendent of Documents, Government Printing Office, Washington, D.C.

UNITED STATES DEPARTMENT OF COMMERCE • Luther H. Hodges, *Secretary*
NATIONAL BUREAU OF STANDARDS • A. V. Astin, *Director*

Calibration Procedures for Direct-Current Resistance Apparatus

Paul P. B. Brooks



National Bureau of Standards Monograph 39

Issued March 1, 1962

For sale by the Superintendent of Documents, U.S. Government Printing Office
Washington 25, D.C. - Price 40 Cents

Preface

The summer of 1960 at the University of California, Los Angeles, I gave a series of lectures on the precise measurement of d-c resistance. These lectures were part of a course on basic measurements and standards in a summer program for industry entitled "The 1960 Statistical Methods in Industry Course." For use in this course, I asked Paul P. B. Brooks of the NBS staff to prepare a detailed description of the procedures used at the National Bureau of Standards for the accurate measurement of d c resistance. In view of the current urgent needs of industry and the military services for information on precision measurement techniques, it was decided to expand and publish this material in the present Monograph.

Because of the recent tremendous growth in standardizing laboratories, and the lack of personnel with training in measurements, it seemed desirable to present this material on d-c measurements in as nontechnical a way as possible. It should then be helpful to the largest number of people, although admittedly containing much detail that is unnecessary for those with scientific training.

JAMES L. THOMAS, *Chief*,
Resistance and Reactance Section,
Electricity Division.

Contents

	Page	Page
face-----	iii	
5 I. General Outline of Equipment and procedures-----	1	
1. Object and scope of this paper-----	1	
2. Errors, corrections, and tolerances-----	1	
3. Basic circuit for d-c measurements-----	2	
4. Resistance standards-----	3	
4.1. Design for precision measurements-----	3	
4.2. Two-terminal versus four-terminal resistance-----	3	
4.3. Stability of resistors-----	4	
4.4. Correction for temperature-----	4	
5. Connections and supports for standards-----	5	
5.1. The mercury stand-----	5	
5.2. Amalgamating solution-----	5	
6. The sensitive galvanometer and accessories-----	6	
6.1. The galvanometer-----	6	
6.2. Damping-----	8	
6.3. Some sources of trouble-----	8	
6.3.a. Temperature-----	8	
6.3.b. Thermoelectromotive forces-----	8	
6.3.c. Vibration of the galvanometer support-----	9	
6.3.d. Magnetic disturbances-----	9	
6.3.e. Continuous small oscillations-----	9	
6.3.f. "Zero drift"-----	9	
6.3.g. Reactive "kick"-----	9	
6.4. The reversing key-----	9	
6.4.a. Advantages-----	9	
6.4.b. Design-----	9	
6.4.c. A convenient battery box-----	10	
7. Miscellaneous-----	10	
7.1. Absolute ohm versus international ohm-----	10	
7.2. Algebra of small quantities-----	10	
7.3. "Rounding off" numbers-----	11	
7.4. Interpolation-----	12	
7.5. Extrapolation-----	12	
7.6. Errors versus mistakes-----	12	
7.6.a. Errors-----	12	
7.6.b. Mistakes-----	13	
8. The Direct Reading Ratio Set. Its use in resistance measurements with a 1:1 ratio-----	13	
8.1. Basic circuit, connections, and precision-----	13	
8.2. Resistance by substitution-----	14	
8.3. Resistance by the interchange method-----	15	
8.4. Comparison of a four-terminal resistor with a two-terminal resistor-----	16	
8.5. Approximate measurement of a small resistance-----	16	
8.6. Determination of the two-terminal resistance of a 1-ohm resistor when its four-terminal value is known-----	17	
9. Measurement of "odd-valued" resistors-----	18	
9.1. "Odd values" distinguished from values of conventional standards-----	18	
9.2. Combinations of resistors-----	18	
9.2.a. Resistors of the same nominal value in series-----	18	
9.2.b. Resistors of the same nominal values in parallel-----	19	
9.2.c. Resistors of different nominal values in series-----	20	
9.2.d. Resistors of different nominal values in parallel-----	20	
9.2.e. Resistors in series and in parallel-----	20	
9.3. Adaptation of the Direct Reading Ratio Set for ratios of 1:n and m:n-----	21	
9.3.a. Typical adaptations-----	21	
9.3.b. "Bridge zero"-----	21	
9.3.c. Applications of above procedures to the measurement of odd values-----	22	
9.3.d. Determination of "bridge zero" with two standards and their corrections-----	24	
9.4. Calibration of megohm boxes and 0.1-megohm boxes for use as resistance standards-----	25	
9.4.a. Calibration of the box-----	25	
9.4.b. Use of the calibrated box as a resistance standard-----	26	
10. The Universal Ratio Set (URS)-----	26	
10.1. The Universal Ratio Set compared to a slide-wire-----	26	
10.2. Application to four-terminal measurements-----	27	
Part 2. Calibration of a Wheatstone Bridge-----	28	
11. Test equipment-----	28	
12. The Wheatstone bridge circuit-----	28	
12.1. Ratio arms, A and B-----	29	
12.2. Rheostat arm, R-----	29	
13. Outline of test procedures-----	29	
13.1. Need for testing-----	29	
13.2. Required measurements-----	29	
13.3. The circuit diagram-----	30	
13.4. Reducing contact resistance-----	30	
13.5. Load tolerance-----	30	
13.6. Applicability of general principles-----	31	
14. Test of open dial bridge-----	31	
14.1. Test 1: Zero and internal lead resistance-----	31	
14.2. Test 2: The rheostat arm-----	33	
14.2.a. Calibration of X and Y-----	34	
14.2.b. The 0.1-ohm-per-step decade-----	36	
14.3. Test 3: The ratio arms-----	36	
14.3.a. The A arm-----	37	
14.3.b. The B arm-----	38	
14.3.c. Working test-----	39	
15. The National Bureau of Standards certificate-----	39	
Part 3. Testing General Purpose Potentiometers-----	40	
16. The Potentiometer—general description-----	40	
16.1. The potentiometer circuit-----	40	
17. Adaptability of the universal ratio set to testing potentiometers-----	41	
17.1. Measurement of voltage ratios-----	41	
17.2. Interpretation of URS readings-----	41	
17.3. "Direct reading" versus "not direct reading"-----	42	
17.4. General outline of test procedures-----	43	
17.4.a. Dial tests-----	43	
17.4.b. Factor tests-----	44	
17.4.c. Standard cell dial-----	44	
17.5. Some modifications of procedure-----	44	
18. Details of procedure as applied to a specific model-----	45	
18.1. Description of potentiometer—Crompton type-----	45	
18.2. Test equipment-----	45	
18.3. Tests required-----	45	
18.4. Points to remember-----	46	
18.5. Testing procedures-----	46	
18.5.a. Connections and dial settings-----	46	
18.5.b. To make the URS "direct reading"-----	46	
18.6. Measurements on the main dial-----	47	
18.7. Measurements on the slide wire-----	48	
18.8. Measurements on the standard cell dial-----	48	
18.9. Finding corrections for the main dial-----	48	
18.10. Finding corrections for the slide-wire-----	49	
18.11. Tabulation of data for the standard cell dial-----	49	
18.12. Factors-----	50	
18.13. Application of corrections-----	50	
18.14. Procedure when the URS is not "direct reading"-----	51	
18.15. A working test-----	51	
19. Sample certificate for potentiometer-----	53	

Calibration Procedures for Direct-Current Resistance Apparatus

Paul P. B. Brooks

The equipment and procedures used at NBS for the precise measurement of d-c resistance are explained in detail. The specific application of these procedures to the calibration of bridges and potentiometers is explained. It is expected that this paper will be of considerable help to the many company and governmental standardizing laboratories now being established.

Part 1. General Outline of Equipment and Procedures

1. Object and Scope of This Paper

This paper describes the apparatus and procedures used at the National Bureau of Standards for the measurement of d-c resistance when an accuracy of a few parts in a million is required. The instruments usually used for this work are the Direct Reading Ratio Set and the Universal Ratio Set. These instruments, together with an assortment of standard resistors, special mercury stands, and galvanometers, switches, and batteries, are used for the calibration of practically all types of d-c measuring instruments.

The object will be to explain procedures in detail and as simply as possible, with a minimum reference to theory. For the reader who wishes to go into greater detail of design and theory, Circular 470 of this Bureau, "Precision Resistors and Their Measurement," or text books on electrical measurements should be consulted.

2. Errors, Corrections, and Tolerances

These quantities may be expressed in units of measurement, proportional parts, percentages, or parts per million.

If the value of a resistor, as measured with a bridge, is 99.7 ohms, whereas its correct value is 100.0 ohms, the error of the bridge measurement is -0.3 ohm. The correction which must be added to the bridge reading to obtain the true value is +0.3 ohm. It is important to avoid confusion between error and correction.

If the bridge reading had been 100.3 ohms, the correction would have been -0.3 ohm.

In a precision measurement, we are concerned with the correction which must be added algebraically to the reading of an instrument or to the nominal value of a resistor to obtain the true value.

In the preceding example, the correction +0.3 ohm, expressed in *proportional parts*, is +0.003, or +0.0003, or +3 parts per 1,000 of the bridge reading.

The correction in proportional parts to be added to the reading of an instrument is equal to the correction indicated by the reading. Likewise, the correction in proportional parts to the nominal value of a resistor is equal to the correction indicated by its nominal value in ohms.

The correction in percent is 100 times the correction in proportional parts. Hence, the correction in the above illustration is +0.3 percent of the bridge reading.

The correction in *parts per million* (ppm) is 1,000,000 times the correction in proportional parts. The above correction is +3,000 parts per million (+3,000 ppm).

Proportional parts \times 100 = percent
Proportional parts \times 1,000,000 = parts per million
Percent \times 10,000 = parts per million

The correction of 3,000 ppm is many times larger than the corrections for good laboratory equipment. However, the difference between 3 000 ppm (0.3 percent) of 99.7 ohms and 3 000 ppm of 100.0 ohms is only 0.0009 ohm. Therefore, in laboratory measurements, it is usually immaterial whether a correction to a resistance is based on its nominal value or on its true value.

A *tolerance* is usually expressed as a percentage. If the certified value of a resistor is 100.003 ohms with a stated accuracy of 0.002 percent, the tolerance is ± 0.002 percent of 100.003 ohms, or ± 0.002 ohm. The true value is within the range 100.003 \pm 0.002 ohms (100.001 to 100.005 ohms).

Resistors are designated by their *nominal values*. Due to limitations on the accuracy of manufacture and to inherent instabilities in resistance materials, some correction, positive or negative, generally must be added to the *nominal value* of a resistor to obtain its *true value*. Since the correction is usually given in parts per million by the special bridges used at the National Bureau of Standards, it must be expressed in terms of the ohm before it can be used.

Example: What is the true value of a resistor if its nominal value is 1 000 ohms and its correction is +57 ppm?

Solution: The correction, +57 ppm, is +0.000057 *proportional parts*; 0.000057 of 1 000 ohms is 0.057 ohm. Since the correction is positive, the true or corrected value is 1 000.000 + 0.057 = 1,000.057 ohms.

A quick and simple solution is expressed in the following rule: *Affix enough zeros to the nominal value to make one million (or a small integral multiple of one million). Underneath, write the correction with its algebraic sign. Add, and place the decimal point consistent with its position in the nominal value.*

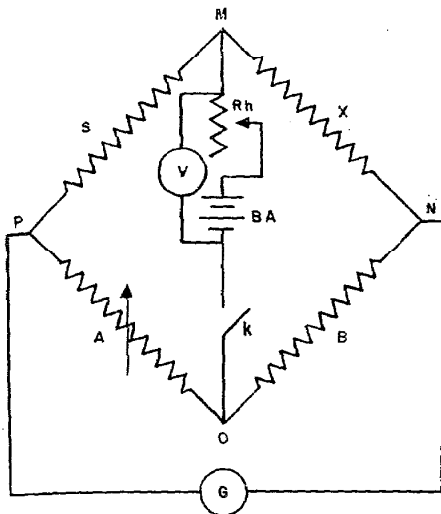

FIGURE 2. Ratio set in a Wheatstone bridge circuit.

In the diagram, S is a resistance standard, X an unknown resistor of the same nominal value, and the ratio arms A and B are the arms of a Direct Reading Ratio Set. G is the galvanometer and V is a voltmeter across the battery, BA, and the battery rheostat, Rh. The current divides at M into parts which are nearly equal through the branches MPO and MNO, thus applying approximately equal loads on these two branches of the network.

The advantage of the circuit of figure 2 is that, since the nominal resistance of each arm, A and B, of a Direct Reading Ratio Set is 100 ohms, the resistance of each branch, MPO, and MNO, for any value of S and X, is always more than 100 ohms. With a sensitive galvanometer excessive current in any part of the bridge circuit may be easily avoided.

On the other hand, if the galvanometer is connected to M and O and the battery is connected to P and N, corresponding to figure 1A, and $R = 1$ ohm, the current through S and X will be 100 times the current through A and B. Though the emf required across the bridge in this case may be considerably less than the emf required in the circuit of figure 2, the current through the one-ohm resistors, nevertheless, will be 100 times as great. Since the heat developed in a resistor is proportional to the square of the current, there is a danger of producing excessive heat. The emf is usually increased in the circuit of figure 2 to obtain adequate galvanometer deflections for values of S and X without overheating any part of the circuit.

4. Resistance Standards

Design for Precision Measurements

The degree of accuracy in resistance measurement is obtained by comparison of an unknown

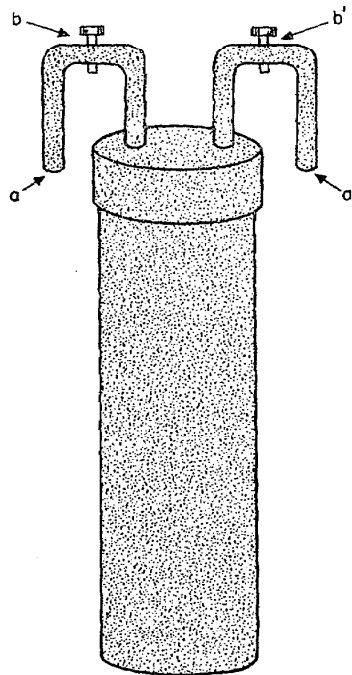

FIGURE 3. NBS standard resistor.

resistance with one which is accurately known. For this purpose, resistance standards, accurate to a few parts in a million, are available in a wide range of values, usually in decimal multiples or submultiples of 1 ohm.

The resistance element of manganin wire is enclosed in a protective case and connected into a circuit by two copper arms, the terminals of which (a, a', fig. 3) are plane, clean, free of corrosion, and amalgamated. The arms with amalgamated terminals are designed to support the resistor with the terminals in mercury cups or on a mercury stand. Contact resistance cannot be ignored when precision is required. Mercury contact resistance may be kept to a few microhms, while clamped contacts will probably offer a resistance of 100 to 1000 microhms. Also, mercury-contact connection can be repeated without significant change in contact resistance. Binding posts (b, b') are usually provided at the top of the arms. The difference in resistance between a and a' and the resistance between b and b' is insignificant in comparison with the resistance of a resistor of large denomination. For a resistor of 1 ohm or less, the difference is important.

4.2. Two-Terminal Versus Four-Terminal Resistance

This leads to consideration of the difference between two-terminal and four-terminal resistance. In figure 4, if the resistance is measured two-terminally between c and d, it is equal to the resistance of R plus the resistance of the leads, ca and bd. Likewise, if the resistance is measured

Examples:

1. The nominal value of a resistor is 1 000 ohms. Its correction is +57 ppm. What is its corrected value? (See block at right).

Nominal value	1 000
Affix 3 zeros	1 000
Add correction	_____
Point off	1 000

The corrected value is 1 000. 057 ohms. If the correction had been -57 ppm, the corrected value would have been 999.943 ohms.

2. Find the corrected value of a 0.001-ohm (nominal value) resistor with a correction of -63 ppm.

Nominal value	0.001
Add 6 zeros	1 000
Add correction	_____
Point off	0.000 999

The corrected value is 0.000999937 ohm.

3. Nominal value, 50 ohms. Correction, +71 ppm. Find the corrected value. The addition of five zeros makes *five* million. Hence, add $5 \times (+71) = +355$ parts per five million.

Nominal value	50.
Affix 5 zeros	50 000
Add correction	_____
Point off	50.0

The corrected value is 50.00355 ohms.

The notation, $R(1+c)$, is a short and convenient method to express the true value of a resistor in terms of its nominal value, R , in ohms and its correction, c , in parts per million. For example, $100(1+27 \text{ ppm})$ shows that 0.000027 of the nominal value must be added to the 100 ohms nominal value to obtain the true value. Hence, the true value is $100 \times 1.000027 = 100.0027$ ohms. Likewise, $10(1-85 \text{ ppm})$ shows that a correction of -85 ppm must be applied to the nominal value of 10 ohms to give the true value of the resistor. The true value is $10(1-0.000085) = 10 \times 0.999915 = 9.99915$ ohms.

In any case, the true value may be found by the method illustrated by the above examples.

3. Basic Circuit for D-C Resistance Measurements

Precise measurements of resistance with the Direct Reading Ratio Set or the Universal Ratio Set make use of a Wheatstone bridge circuit in which the ratio set forms the ratio arms.

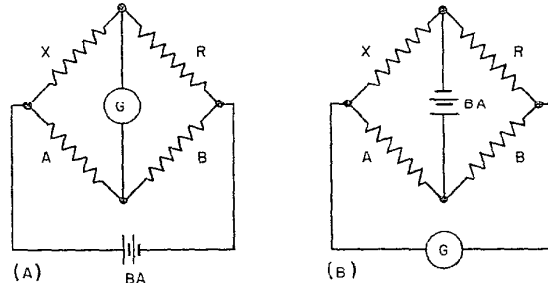

FIGURE 1A AND B. Wheatstone bridge circuit.

The Wheatstone bridge circuit is represented schematically in figures 1A and 1B, where X, A, and B represent the arms of the bridge and their respective resistances. Resistors A and B are variable. X is a resistor of unknown value and R is a known resistor. G is the galvanometer and BA is a battery of suitable voltage. In addition to the components shown in the diagram, a key or switch is in the battery branch of the circuit. A key, if present in the galvanometer branch, is usually kept closed during measurements. A variable resistor or battery rheostat in the battery branch serves to adjust the voltage across the bridge arms. A voltmeter across the battery and the battery rheostat will indicate applied voltage.

When the battery and galvanometer key are closed and the variable resistors in the bridge arms are adjusted to reduce the current through the galvanometer to a minimum, the bridge is to be "balanced." When the bridge is balanced, the value of X is given by the basic equation

$$X = \frac{A}{B}R.$$

This equation applies regardless of the relative locations of battery and galvanometer as shown in the above diagrams. The choice of arrangement is determined mainly by the distribution of current in the arms of the bridge. Current which induces excessive heat in any branch will impair accuracy of measurement.

The circuit arrangement generally used for measurements with a ratio set is shown in figure 1B.

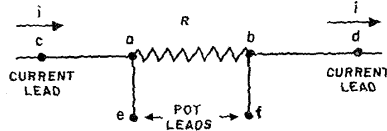

FIGURE 4. Four-terminal resistance.

two-terminally between e and f, it includes the resistance of the leads, ea and fb. However, if current leads go through c and d and potential leads go through e and f, the measurement gives the resistance between the junction points a and b, regardless of resistance of current leads or potential leads. The four-terminal measurement is based on the fall of potential across R compared with the fall of potential across a resistance standard in series with R, with a constant current through the two resistors.

Four terminal measurement is necessary in testing laboratory instruments, such as Wheatstone bridges and potentiometers, in which connection to a given resistor can be made only through other resistors.

The resistance of the connecting arms of a resistance standard of small denomination is proportionally large compared with the resistance of the element. Hence, standards of a nominal value of 1 ohm or less are calibrated four-terminally. The current leads of 1-ohm standards enter through the amalgamated terminals, a, a', and the potential leads are taken to the top binding posts, b, b' (fig. 3). The potential leads for standards of smaller denomination go to extra binding posts mounted on the insulating cap of the protective case with leads to the enclosed resistance element.

The National Bureau of Standards usually certifies the four-terminal values for standard resistors of 1 ohm or less, the two-terminal values for all others. The two-terminal values for 1-ohm standards are certified only if they are requested. In some testing procedures, the two-terminal value

of a 1-ohm standard may be required. The two-terminal values of the NBS-type standards of recent manufacture are usually 40 to 50 microhm greater than the four-terminal values. However, in different makes the difference between the two-terminal values may be considerable. If the two-terminal value of 1-ohm resistor is not given, it may be measured readily with a Direct Reading Resistance Set. The method will be explained in section 8

4.3. Stability of Resistors

The value of a resistor is not perfectly constant. It changes with time and with temperature; unsealed resistors, such as those in bridge potentiometers, etc., are affected by humidity. A severe shock, such as a fall on the floor, may change the value of a resistor and impair stability. Overloading may result in permanent damage. A load that does not exceed $\frac{1}{10}$ watt is desirable. However, 1 watt is usually a safe load, probably with a decrease of accuracy.

Modern resistance standards are quite stable. An annual change of more than 20 ppm is excessive. The average yearly change of seven hundred standards calibrated at the National Bureau of Standards was less than 10 ppm. However, a standard that has not been calibrated for several years cannot be relied on for precise measurements.

The resistance standards maintained at the National Bureau of Standards are subject to small changes of temperature and are recalibrated regularly at 25.0 °C to the nearest part per million. Well aged standards submitted to the National Bureau of Standards usually are certified to nearest 20 ppm at 25.0 °C. New standards usually are certified to 50 ppm.

4.4 Correction for Temperature

If a resistance standard is used at some temperature other than the temperature at which it is calibrated (25.0 °C), a correction must be applied to its certified value.

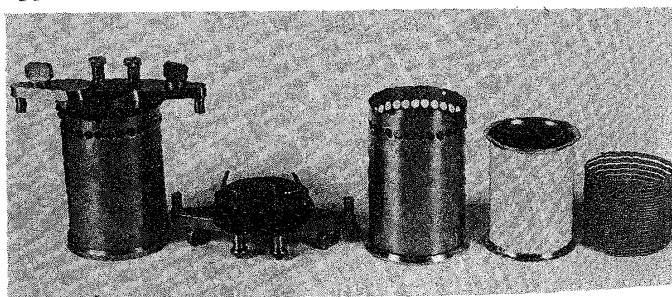

Components of 1-ohm standard resistor of type used at the National Bureau of Standards to maintain the ohm.

Left to right: complete standard, top terminal assembly, outer wall, inner wall, annealed resistance coil.

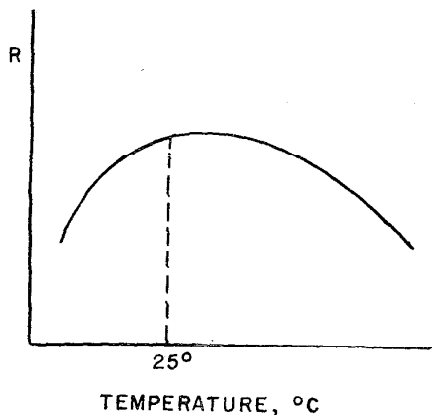

FIGURE 5. Temperature-resistance curve of manganin wire.

The resistance of manganin wire increases as the temperature rises until it reaches a maximum at some point between 20 and 50 °C (fig. 5). The resistance then decreases to a minimum as the temperature rises, and then increases again. Within the range of usual room temperatures, the resistance may be accurately expressed by the following equation:

$$R_t = R_{25}[1 + \alpha(t - 25) + \beta(t - 25)^2].$$

In this equation, t is the temperature of the resistor and R_t is its resistance at t °C. R_{25} is its resistance at 25 °C. Alpha (α) and beta (β) are its temperature coefficients. The Bureau determines the temperature coefficients if they are requested. They do not need to be redetermined because temperature coefficients do not change appreciably with age.

The following example illustrates the application of the temperature coefficients. The resistance of a certain standard is 100.006 ohms at 25.0 °C. Its temperature coefficients are $\alpha = 0.0000063$ and $\beta = -0.0000051$. When these numbers are substituted in the above equation, the resistance at 20.0 °C, rounded off to the nearest thousandth ohm, is found to be 100.002 ohms.

The need for the temperature correction is determined by the accuracy required and the temperature at which a test is made. In the above example the temperature correction for the resistance at any temperature between 24 °C and 26 °C is less than 10 ppm.

Connections and Supports for Standards

The binding posts on the lead arms of resistance standards of small denominations (1 ohm or less) are intended for potential leads in four-terminal measurement. The binding posts on the arm of resistors of greater value may be used for connecting two terminal measurements if high precision is not required or if the value of the resistor is large enough to make the contact resistance

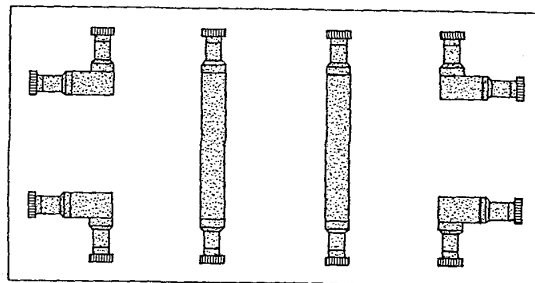

FIGURE 6. Top of mercury stand.

negligible. For precision, standards should be supported on a mercury stand to reduce contact resistance to a minimum and to permit repetition of the measurements within a few parts in a million. Mercury cups, which are sometimes used, are difficult to clean. A pool of mercury is unnecessary. A flat amalgamated surface is quite satisfactory.

5.1. The Mercury Stand

Figure 6 illustrates the arrangement of the nickel-plated copper contact blocks and the binding posts of the NBS mercury stand. The blocks are $\frac{3}{8}$ in. square with a length of about $3\frac{1}{2}$ in. for the long pair and $1\frac{1}{2}$ in. for the short blocks. The upper surfaces are plane, clean, and well amalgamated. The spacing and the height of the supporting posts permit resistors to hang freely between the blocks. The blocks are effectively insulated from the supporting posts which extend upward from the base.

The mercury stand offers several advantages in addition to its low contact resistances. Standards may be quickly connected into a circuit, removed, or interchanged. A connecting or shorting link is useful to fill a gap in a circuit when a standard is to be shorted out or removed. Standards on the stand may be connected into two arms of a bridge circuit. Two resistors may be placed in parallel on the stand, or as many as five may be connected in series. Two or more stands may be connected by short leads between their binding posts, or by shorting links.

A shorting link is a practical and essential accessory to the stand. The link used at NBS is a nickel-plated copper rod $\frac{1}{4}$ in. in diameter and about $3\frac{1}{2}$ in. long with right angle bends which space the ends 3 in. apart, center to center. The ends are plane and amalgamated to make good contact with the amalgamated surfaces of the stand. A link of this description will have a resistance of about 40 microhms.

5.2. Amalgamating Solution

Contact surfaces occasionally need to be cleaned and re-amalgamated. A satisfactory amalgamating solution consists of:

- 1 oz water
- $\frac{1}{2}$ oz mercurous nitrate
- $\frac{1}{4}$ oz concentrated nitric acid.

Stir the mixture. If it does not become clear, warm *slightly*. Some mercurous nitrate will precipitate when the solution cools. An added drop of mercury will improve the keeping qualities. The proportions in this solution may be varied considerably. Caution should be observed in handling nitric acid and poisonous compounds of mercury.

The surface to be amalgamated should be clean and free of grease and corrosion. After the solution is applied, the surface should be washed free of corrosive chemicals with water and a small drop of mercury applied.

6. The Sensitive Galvanometer and Accessories

6.1. The Galvanometer

Galvanometers used in direct current measurements usually employ the D'Arsonval movement, which consists of a movable rectangular coil supported in the magnetic field between the pole pieces of a permanent magnet. A current through the coil will produce a "turning force" or torque which will turn the coil about its vertical axis until it is brought to rest by the opposing torque due to the stiffness of the suspension.

Commercial galvanometers are of many types and models with different sensitivities suited to specific uses. However, at the National Bureau of Standards, only one type is used for resistance measurements in testing resistors, bridges, potentiometers, etc. Specifications for this type will be given after the following description.

The moving element of the galvanometer is a flat rectangular coil suspended between the soft iron pole pieces, P, P', of a permanent magnet, PM, figure 7. The plane of the coil, at rest, is parallel to the field of the magnet. A soft iron core, C, is fixed inside the coil. The sides of the coil are free to rotate in the narrow gap between

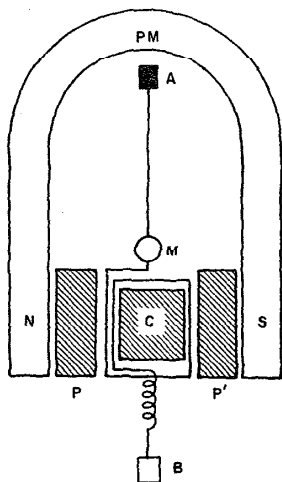

FIGURE 7. The D'Arsonval galvanometer movement.

6

the pole pieces and the core. This condition necessitates careful leveling of the galvanometer. A small mirror, M, is attached to the upper of the coil and rotates with it.

The upper suspension is a thin, narrow, copper ribbon between the supporting stud, A, and the coil. The upper suspension serves three purposes: (1) it supports the coil; (2) it serves as a current lead to the coil; and (3) it provides a restoring torque in opposition to any rotation of the coil.

The lower suspension is a loose coil of copper wire from the lower end of the coil to the stud, B. It offers negligible opposition to rotation of the coil and serves only as a current lead. The studs, A and B, are connected to binding posts.

A metal case encloses the instrument to shield the coil from air currents. A window in the case permits a light beam to be reflected from the mirror and affords a view of the coil, pole pieces, and core. A lens of suitable focal length focuses the light beam on a scale. Leveling screws on the base can be adjusted so that the coil can rotate freely in the narrow gap between the pole pieces and the core.

The torque which causes the coil to rotate about its vertical axis is proportional to the current and is directed clockwise or counterclockwise, depending on the direction of the current. The opposing torque due to the twist of the suspension is proportional to the angle of rotation. The angle through which the coil rotates before it is brought to rest by the opposing torque is proportional to the current. Oscillations of the coil about the rest position can be controlled by suitable damping.

When galvanometer deflections are read by use of a light beam reflected from a mirror on a scale, small deflections on the scale are approximately proportional to the current. If the distance from the mirror to the scale is 100 cm and the limiting deflection on the scale is 15 to 20 degrees, depending on the accuracy required. How resistance measurements are rarely made by galvanometer deflection. Resistance measurements are usually made in a bridge circuit adjusted to obtain minimum deflection of the galvanometer. A perfect zero deflection or "null" reading on a galvanometer is frequently impossible.

The indicator is a narrow beam of light reflected from the mirror to a ground glass scale (figure 8). The light source used at NBS is a standard filament lamp. These lamps are rated at 10 v; hence the line voltage must be stepped

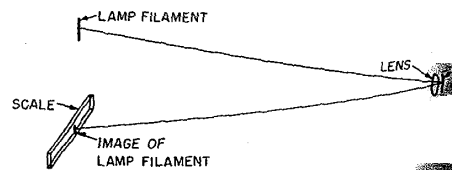

FIGURE 8. Arrangement of lamp, mirror, and reflecting galvanometer.

down by a transformer. A shield around the lamp allows the light to pass through a narrow slit to the galvanometer mirror. A lens of suitable focal length focuses the reflected light on a ground-glass millimeter scale. By adjusting the distance from the mirror to the scale, or the light source, or both, a sharp image of the lamp filament may be obtained on the scale. The image of the lamp filament is observed from the opposite side of the scale. A standard distance from mirror to scale is 100 cm. With a lens of greater focal length, a distance of 150 cm can be used with satisfaction. In effect, the light beam provides the rotating coil with a weightless pointer about 200 to 300 cm long.

The scale is of ground glass graduated in centimeters and millimeters. The zero on the scale may be at either end or in the middle. It is not necessary to set the "rest" position of the indicator on the zero graduation of the scale. The deflection from any "rest" position is readily obtained.

If the galvanometer is used only as an indicator, a very small deflection is sufficient. If however, an interpolation is to be made, or a measurement is to be made by galvanometer deflection, the deflection must be large enough to be read accurately.

The specifications for a sensitive galvanometer usually include: (1) sensitivity, (2) CDRX, that is "critical damping resistance external," (3) period, and (4) coil resistance.

The following specifications are from the maker's label on one galvanometer used at NBS for resistance measurements:

- (1) Sensitivity: 0.08 microvolt/millimeter ($\mu\text{v}/\text{mm}$)
- (2) CDRX: 50 ohms.
- (3) Period: 8.8 sec.
- (4) Resistance: 17.6 ohms.

The specifications will differ somewhat for each galvanometer. A repair or replacement of a suspension will change its specifications somewhat. If the sensitivity is adequate, variations of 10 to 20 percent in the other constants are usually acceptable.

The sensitivity given above is the voltage sensitivity. Evidently the voltage across the galvanometer branch which will produce a deflection of one division on the galvanometer scale (or the number of scale divisions of deflection caused by a microvolt (μv)) will depend on the resistance of the circuit. Hence, the sensitivity can be specified only for a given resistance in the galvanometer circuit. For sensitive galvanometers, American manufacturers generally specify voltage sensitivity in microvolts per millimeter when the external resistance in the galvanometer circuit is equal to the CDRX with the scale 100 cm from the galvanometer. The above specification of voltage sensitivity means that with a resistance in the galvanometer circuit of 67.6 ohms (CDRX plus galvanometer resistance), 0.08 μv will produce a

deflection of 1 mm on a scale at a distance of 100 cm from the galvanometer. Note that the smaller the fraction of a microvolt, the greater the sensitivity.

The sensitivities of the galvanometers used for resistance measurements at the Bureau are usually expressed in millimeters per microvolt at a scale distance of 150 cm. The increased scale distance gives larger deflections, and the reflected light spot on the ground-glass millimeter scale is still bright enough to be readable in adequate room lighting. The above sensitivity would be 1/0.08, or 12.5 mm/ μv at 100 cm and it would be about 18.8 mm/ μv at 150 cm. Note that, expressed in this way, the larger the numerical expression of sensitivity, the greater the sensitivity. This seems like a logical way of expressing sensitivity.

The term "sensitivity" is often used loosely in the sense of "readability." The sensitivity depends upon certain characteristics of design. As long as none of these characteristics are changed, the specified sensitivity remains fixed. If a very small current through the galvanometer does not give an observable deflection, a larger current may give a readable deflection. The sensitivity has not changed.

The accuracy of resistance measurements may be adversely affected by either too low or too high a sensitivity. Suppose a galvanometer of low sensitivity is used with the Direct Reading Ratio Set to measure a resistance. To get enough current through the galvanometer to obtain an observable change in the deflection for a change of one step on the lowest dial of the ratio set, it may be necessary to increase the voltage across the test circuit until excessive current raises the temperature, resulting in incorrect results or even damage to the equipment.

On the other hand, too high a sensitivity is accompanied by a slow movement of the galvanometer coil, which makes reading tiresome. Of more importance is the fact that the greater the sensitivity the more the galvanometer is affected by thermal emf's, which may make accurate readings difficult or, in extreme cases, impossible. A sensitivity between 10 and 30 mm/ μv at 150 cm has been found generally satisfactory for resistance measurements.

The CDRX is the resistance in the galvanometer circuit, in addition to the galvanometer resistance, which will cause the galvanometer to complete a deflection and stop without oscillation. This condition is known as critical damping, which will be discussed in section 6.2. The CDRX is usually several times the galvanometer resistance.

The period is the time required for the undamped coil to make one complete oscillation. If a small current is sent momentarily through the coil and the circuit immediately opened, the coil will oscillate freely until the oscillations die out due to the damping action of the air and the molecular friction in the suspensions. The time required for the coil to move from one extreme

position to the other, then back to the first, or, the time from the rest position to one extreme, then to the other extreme, and back to the rest position is the period. About 5 to 10 sec is generally a satisfactory period for a sensitive galvanometer.

The galvanometer resistance is the resistance of the coil and its suspensions. It is generally less than the CDRX.

As has been stated, galvanometers of the same type will vary in their specifications. The following table gives the range of specifications for different sensitive galvanometers used in the resistance and reactance laboratory at the Bureau.

Sensitivity:	10 to 30 mm/ μ v at 150 cm.
CDRX:	40 to 80 ohms.
Period:	5 to 10 sec.
Resistance:	About 15 or 20 ohms.

6.2. Damping

If a momentary emf is applied to a galvanometer and the circuit immediately opened, the coil will oscillate freely as a torsion pendulum. The period for a sensitive galvanometer will probably be between 5 and 10 sec. The oscillations will be "damped," that is, they will gradually decrease, due to friction with the air and molecular friction in the suspension, until, after several oscillations, the coil will come to rest. If the coil is part of a closed circuit, the oscillations will die out more quickly due to the damping effect caused by the rotation of the coil in a magnetic field. The degree of damping will depend upon the resistance of the circuit, including the galvanometer resistance and the resistance of the external circuit. For each galvanometer, there is a *Critical external damping resistance (CDRX)*. With *critical damping*, the coil swings to its steady position and stops without oscillation. With *under-damping*, the coil may oscillate before it settles to a steady position. With *over-damping*,

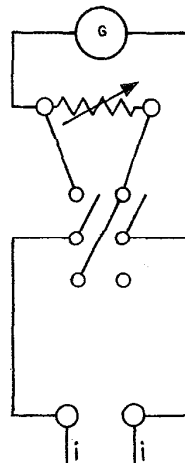

FIGURE 9. Connection of damping resistor in galvanometer circuit.

the coil is sluggish and the reading time is prolonged, until the coil completes its deflection.

For a damping resistor, a dial box with a range of 100 ohms in 10-ohm steps is usually adequate. This may be connected into the circuit with a double-pole double-throw switch as shown in figure 9. With the blades of the switch in upper position, the variable resistor is in parallel with the galvanometer and, with the blade in the lower position, the resistor is in series in circuit.

Practically, the best damping is little less than critical. The galvanometer "overshoots" slightly and settles back to its final position. The reading time is not excessively long, while the overshoot and return of the galvanometer to its final position assures the observer that the coil swings freely.

Usually, the experimenter will find the damping best suited to his work by trial and error. However, a knowledge of the critical external damping resistance of the galvanometer and of the resistance of the apparatus in the circuit may save some needless trials.

For example, the CDRX of a certain galvanometer is 50 ohms. If the circuit external to the galvanometer has a resistance of 50 ohms, the galvanometer is critically damped. If the external resistance is less than 50 ohms, the galvanometer is over-damped. Additional resistance in series in the circuit is needed. If the external resistance is more than 50 ohms, a *parallel* resistance is required. In either case, the effective sensitivity is reduced.

During use, it is preferable that the galvanometer circuit remain closed. That will, to some extent, damp oscillations due to vibration or other extraneous sources, and will eliminate thermal emf's introduced by closing a switch in the galvanometer circuit.

6.3. Some Sources of Trouble

6.3.a. Temperature

Variations of temperature affect not only the galvanometer, but every branch of the circuit in which it is a part. The laboratory should be kept at a constant uniform temperature, free from drafts. When the battery key is closed, heat is produced in the circuit in proportion to the square of the current, the resistance of the circuit, and the time of current flow. Hence, the emf of the battery should be only large enough and the key should be depressed only long enough to get a definite reading on the galvanometer scale. When measurements are made with a potentiometer, a constant current is required in the instrument. In that case, the current should flow long enough to establish a stable heating condition in the potentiometer circuit.

6.3.b. Thermoelectromotive Forces

If two conductors in a circuit are of different composition and the temperature at their junction is different from the temperature at other parts

In the circuit an electromotive force will be produced. To minimize these thermoelectromotive forces, only copper lead wires should be used, and precautions should be taken to maintain uniform temperature throughout the circuit. The heat from a hand resting on an instrument panel will sometimes produce an erroneous deflection of the galvanometer.

6.3.c. Vibration of the Galvanometer Support

The sensitive galvanometer is quite susceptible to vibration. Running machinery in the building, a heavy truck on the pavement near the laboratory, strong wind gusts against a wall on which the galvanometer is mounted, or even an earthquake some thousands of miles away, may disturb the sensitive movement. The instrument should be mounted on the steadiest support possible.

6.3.d. Magnetic Disturbances

The galvanometer is sensitive to the magnetic fields of nearby motors, generators, etc.

6.3.e. Continuous Small Oscillations

After major disturbances have been reduced to a minimum there may still persist oscillations of small amplitude of unknown cause. They make it difficult to determine the "zero" or rest position on the galvanometer scale, and also, to obtain an accurate reading of a deflection.

6.3.f. "Zero Drift"

After a deflection, the galvanometer may not return to its initial rest position. This shift of zero may be negligible if the deflection is small.

Another type of zero shift is a continuous slow drift in one direction or the other.

6.3.g. Reactive "Kick"

When a circuit which contains one or more coils of wire is closed or opened, an instantaneous emf, which either aids or opposes the impressed emf, is produced in the coil. The resulting surge of current gives the galvanometer a temporary deflection different from the deflection produced by a steady current. The effect will be especially noticeable in resistance coils of large denomination. It is important to recognize the "kick" and to allow the galvanometer to settle to a steady state before taking a reading.

6.4. The Reversing Key

6.4.a. Advantages

Use of a reversing key reduces some of the errors arising from disturbances listed above, eliminates others. After a deflection has been read, the current through the bridge is immediately reversed and the deflection in the opposite direction is read. The "spread" between the two deflections is double a single deflection. Any error in reading is

proportionately reduced. The deflection is doubled, but errors due to thermal emf's, zero drift, etc., are not increased. If there is a steady drift of galvanometer zero, it is in the direction of one deflection, opposite to the other. The same is probably true for deflections due to thermoelectromotive forces. The effect of persistent oscillations of the galvanometer may be reduced by making several reversals which are not coincident with the oscillations and using the average of the double deflections.

6.4.b. Design

Figure 10 represents, in a somewhat simplified form, the essential elements of a reversing key. Two keys of spring brass or phosphor bronze, A, A, are fastened to an insulating base at B, B. The spring strips or keys pass under a yoke, C. Adjusting screws pass through the yoke to make contact with the springs. At the free ends of the springs are buttons of insulating material, D, D, for depressing the keys with the finger tips. When the keys are depressed, they make electrical contact with the studs, E, E, in the base. Binding

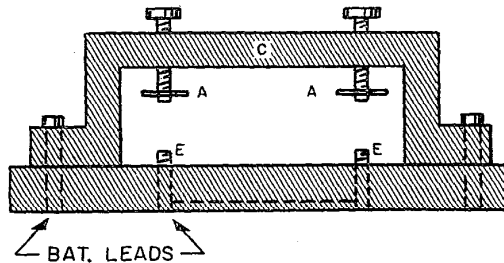
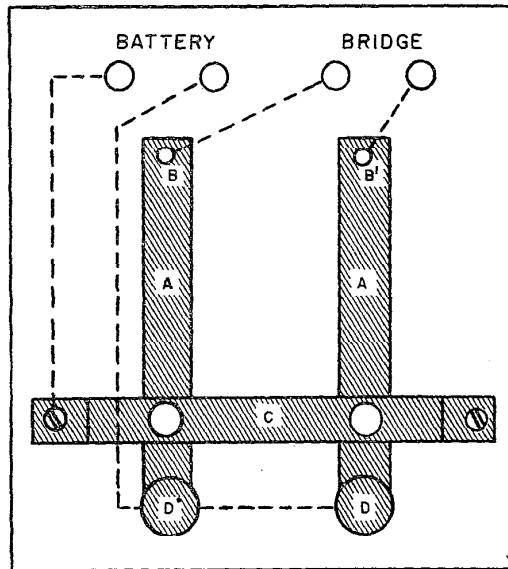

FIGURE 10. Reversing key.

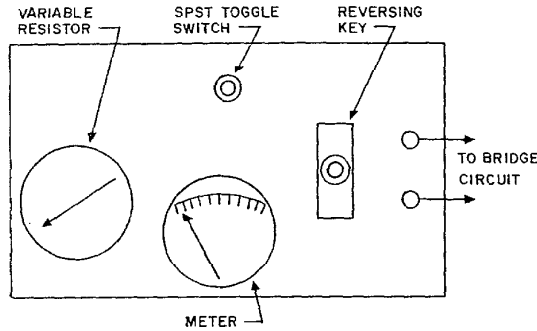

FIGURE 11A. Panel of battery box.

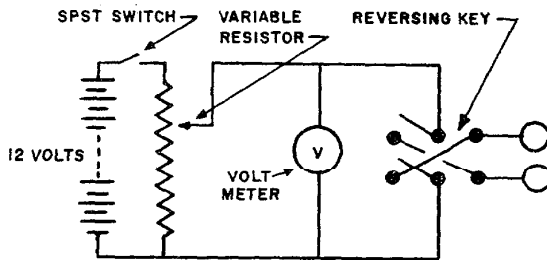

FIGURE 11B. Wiring diagram of battery box.

posts for battery and bridge connections are provided as shown. The conducting wires beneath or within the base are shown by broken lines. Wires from one pair of binding posts go to the spring strips. One binding post of the other pair is connected to the yoke, the other is connected to both contact studs in the base.

If the battery is connected to one pair of binding posts and a bridge or other apparatus is connected to the other pair, there will be no current as long as both keys are up in contact with the yoke, nor when both keys are depressed. If one key is depressed, current will flow through the apparatus. If the first key is released and the other key is depressed, current in the apparatus will reverse.

It does not take a great deal of mechanical skill to build a key similar to the one described. It has the decided advantage that it may be tapped lightly to check on the proper functioning of the apparatus with which it is being used.

6.4.c. A Convenient Battery Box

The battery box illustrated in figures 11A and 11B combines the reversing key, battery, variable resistor, and voltmeter in one compact unit. The unit illustrated uses a lever-action, 2-pole, 3-position, spring-return switch wired to make a reversing key which will fit into the limited space on a 4 in. x 10 in. panel. By increasing the length of the panel and box, a tapping key of the type described above may be used instead of the lever action switch. The battery consists of two 6-v dry batteries in series. The battery switch is a single-pole, single-throw, toggle switch. The variable

resistor of about 2 000 ohms is the rotary type commonly listed among radio parts as a "potentiometer." It serves as a "voltage divider" to regulate the voltage at the binding posts. The meter is a high-resistance voltmeter.

7. Miscellaneous

7.1. Absolute Ohm Versus International Ohm

Electrical units are defined in terms of fundamental units of length, mass, time, and permeability of free space. Since the "absolute electrical units originally chosen were not of a magnitude suitable for practical measurement, a set of practical units related to the absolute units by a simple factor was required. Prior to 1948 the practical unit of resistance was the *International Ohm*, which was defined in terms of a "reproducible standard" as the resistance at 0°C of a column or thread of mercury of uniform circular cross-section and specified length and mass. In 1948 the International Ohm was abandoned by the national standardizing laboratories and was replaced by a unit very accurately defined in terms of the defining units of length, time, and permeability. Such a unit is maintained by groups of wire-wound resistors of stability of which is checked by repeating measurements in terms of the defining units. National laboratories use essentially the same unit which they check against one another through the International Bureau of Weights and Measures.

The absolute determination of the ohm requires highly skilled techniques and months of tedious work with very special apparatus. Hence, determination is made at rather rare intervals. In this country the ohm is determined by the average value of the resistance of ten Thomas-Baird 1-ohm resistance standards at the National Bureau of Standards, specially constructed and maintained to insure a very high degree of stability. This value is compared with the absolute determination as often as required.

Resistance measuring equipment which was made before 1948, and calibrated in International Ohms, when recalibrated in Absolute Ohms, have corrections about 0.05 percent larger.

7.2. Algebra of Small Quantities

There are no exact measurements. Though a measurement may be accurate to better than one part per million, it is, nevertheless, approximate. Some mathematical operations may be approximate, yet accurate, if the results are as close to the exact value as can be expected from the measurements on which they are based.

Consider the product,

$$(1+a)(1+b) = 1+a+b+ab.$$

If a and b are each less than 0.001, then ab is less than 0.000001. Hence, for small

of a and b , the approximation,

$$(1+a)(1+b) = 1+a+b,$$

is accurate to better than one part per million.

The same principle applies to the following:

$$\frac{1}{1+c} = 1-c+c^2-c^3+\dots \text{ etc.}$$

If c is very small, the terms c^2 , c^3 , etc., that is, all terms above the first degree in c , are negligible. An accurate approximation is then

$$\frac{1}{1+c} = 1-c.$$

Likewise,

$$\frac{1+a}{1+b} = 1+a-b, \text{ approximately,}$$

and

$$\frac{A(1+a)}{B(1+b)} = \frac{A}{B}(1+a-b).$$

Suppose that A and B are the nominal values of the ratio arms of a Wheatstone bridge and that a and b are their respective corrections in proportional parts. Let $A=1000$, $B=100$, $a=+0.00003$, and $b=+0.00002$. Then,

$$\begin{aligned} \frac{A(1+a)}{B(1+b)} &= \frac{1000(1+0.00003)}{100(1+0.00002)} \\ &= 10(1+0.00003-0.00002) \\ &= 10 \times 1.00001 \\ &= 10.0001. \end{aligned}$$

Compare this result with the following result obtained by long division:

$$\frac{A(1+a)}{B(1+b)} = \frac{1000.03}{100.002} = 10.000999+.$$

Since the values of the ratio arms are certified to the nearest part per hundred thousand, the result is rounded off to 10.0001.

The preceding method of approximation may be used to find the correction in parts per million to the nominal value of n resistors in parallel.

For simplicity, the problem will be limited to three resistors each with a nominal value, r , and small corrections c_1 , c_2 , and c_3 , respectively. Then,

$$\begin{aligned} \frac{1}{R} &= \frac{1}{r(1+c_1)} + \frac{1}{r(1+c_2)} + \frac{1}{r(1+c_3)} \\ &= \frac{1}{r}(1-c_1+1-c_2+1-c_3) \\ &= \frac{1}{r}[3-(c_1+c_2+c_3)] \\ &= \frac{3}{r}\left(1-\frac{c_1+c_2+c_3}{3}\right), \text{ approximately.} \end{aligned}$$

Let

$$\frac{c_1+c_2+c_3}{3} = c.$$

Then,

$$\frac{1}{R} = \frac{3}{r}(1-c), \text{ and } R = \frac{r}{3} \cdot \frac{1}{1-c} = \frac{r}{3}(1+c).$$

The correction to the nominal value, $r/3$, of the three resistors in parallel is

$$c = \frac{c_1+c_2+c_3}{3}.$$

Extension of this method to n resistors gives

$$c = \frac{c_1+c_2+c_3+\dots+c_n}{n}.$$

7.3. "Rounding Off" Numbers

The result of a measurement usually will include one or more uncertain digits. The doubtful digits are partly the result of probable errors in calibration, partly the result of limitations to the accuracy of the calibrated instrument in use. Hence, one or more digits are dropped from the results of the measurement.

The following rules for "rounding off" numbers are suggested. The five-digit examples are rounded off to four digits. No decimal point is shown in the examples. If the decimal follows the digit to be dropped, then the dropped digit is replaced by zero.

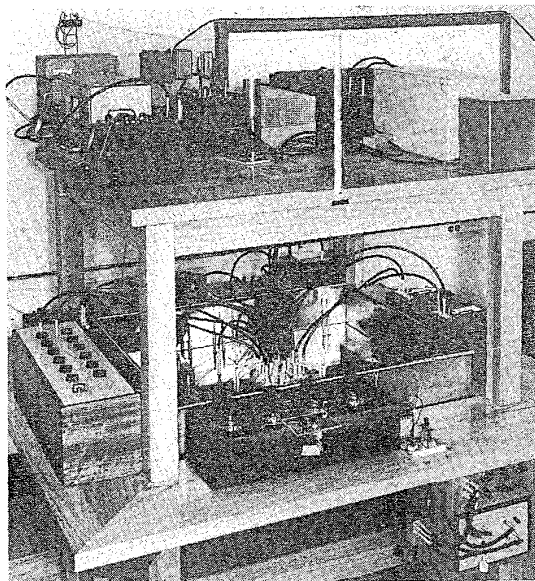

Apparatus for evaluating a 1-ohm resistor in terms of a computable capacitor and frequency.

This gives its value in terms of length, time and an assumed value for the permeability of free space, in accordance with the definition of the ohm.

efficient care). They can and should be eliminated by adequate checks.

For this discussion, it is convenient to classify errors as of *instrumental* origin or of *personal* origin.

For illustration of an instrumental error, assume that a certain steel tape is 1 percent too long. No matter how many measurements are made with it, there is always an instrumental error of +1 percent. The error is also cumulative. If the tape is used (without correction) to lay off a line 100 ft long, the true length of the line is 101 ft, and the error is 1 ft. If it is used to lay off a line 1 000 ft long, the actual length of the line is 1 010 ft and the error is 10 ft.

Personal errors (not mistakes) are largely due to limited powers of observation, as for example, visual acuity. Say an experienced observer must make an accurate measurement of the diameter of a circle using a steel scale with decimal graduations. He will probably estimate a fraction of the smallest division on the scale and determine a value to 0.001 in. Since the resolving power of a human eye is about 0.003 in. (a hair's breadth), the measurement may be in error by that much. He makes several unprejudiced measurements, usually some of his errors will be positive, some negative. The average result of several trials, \bar{x} , may be accepted as *probably* more reliable than a single measurement.

"Multiplying" devices have been designed to extend the powers of observation. In the field of visual observation, there are vernier scales, goniometers, measuring microscopes, etc. A beam of light reflected from a mirror of a galvanometer signifies an almost imperceptible rotation of the scale into an easily readable deflection on the scale. Although refinements in equipment and measuring techniques have reduced tolerances in some cases almost unbelievably, the result of a measurement is still limited by the accuracy of observation.

7.6.b. Mistakes

Mistakes may be made in taking a reading, in recording a reading, in copying data, or in making computations.

A mistake may result from "prejudice." An experienced observer, especially, may report the length of a line as 10.00 cm because he expected it to be 10.00 cm. However, the length of the line may have been slightly short of 10.00 cm, and he should have observed and reported the length as 9.99 cm. Instead, he read on the scale his preconceived notion rather than an accurate observation.

Accuracy in reading scales depends on unprejudiced judgment as well as visual acuity. When an instrument is calibrated, at least two readings should be made, preferably by different observers. Say the instrument is a potentiometer to be calibrated with a Universal Ratio Set. After the first trial, the connections of the potentiometer to the Universal Ratio Set should be changed for the second trial so that the readings of the second test will not duplicate those for

the first. The results of the two tests should agree within reasonable tolerances. Any excessive disagreement between two results for the same dial setting on the potentiometer indicates a mistake. If the mistake is not found in the computation, measurement should be repeated.

If a bridge is calibrated, a different set of resistance standards should be used for each of the two trials. As in the preceding case, discrepancies in the results of the two tests, in excess of reasonable tolerances, indicate mistakes. However, unsatisfactory results for every step on the same dial of the bridge may indicate a faulty standard resistor.

If interpolation is necessary, great care is necessary to avoid mistakes. If corrections to dial readings on the ratio set are required, attention must be given to the algebraic sign of each correction and the correction must be added algebraically to the dial reading. Corrections should not be confused with errors. They are of opposite algebraic sign. A mistake in an algebraic sign is a 200 percent mistake.

Observations should be entered directly in the laboratory notebook, not made on a scratch pad to be copied later.

Another mistake to be avoided is misplacing the decimal point. An engineer, when he saw the collapse of a bridge that he had designed, is said to have exclaimed, "There goes my decimal point!" Figuratively, many bridges have failed because of a misplaced decimal point. Computations need to be checked and rechecked, preferably by different persons.

After mistakes have been eliminated, there remain the indeterminate errors. The last digit of a resistance measurement is usually uncertain. In some cases, additional digits are meaningless. Therefore, the measurement is rounded off to the last significant figure.

8. The Direct Reading Ratio Set. Its Use in Resistance Measurements With a 1:1 Ratio

8.1. Basic Circuit, Connections, and Precision

As was stated at the beginning, the Direct Reading Ratio Set is used at the National Bureau of Standards for a large part of the measurements of d-c resistance. The Direct Reading Ratio Set (or DRRS) is designed to measure, with great accuracy, a difference of not more than 0.5 percent in the resistance between two resistors. The essential panel features of the set are shown in figure 13. A schematic representation of the cir-

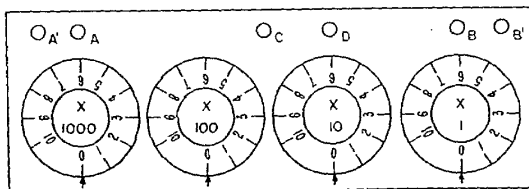

FIGURE 13. Four-dial Direct Reading Ratio Set.

1. If the digit to be dropped is less than 5, leave the digit to its left unchanged.

Example: 87 643 is rounded off to 8 764.

2. If the digit to be dropped is greater than 5, increase the digit to its left by 1.

Example: 38 927 is rounded off to 3 893.

47 698 is rounded off to 4 770.

3. If the digit to be dropped is exactly 5, make the digit to its left the nearest even number.

Example: 52 525 is rounded off to 5 252.

52 535 is rounded off to 5 254.

"Odd" may be substituted for "even" in rule 3, but one or the other usage should be followed consistently.

7.4. Interpolation

The use of a three-dial Direct Reading Ratio Set or a five-dial Universal Ratio Set requires interpolation of the last digit of a reading when that accuracy of measurement is required. For example, the dials of the DRRS in figure 12 show only three digits of the reading, hence the last digit is zero, if readings are expressed as parts per million. The reading is 5 370. Suppose that at this setting of the DRRS, the galvanometer deflection is 8.3 scale divisions and that the direction of the deflection shows that the reading is too small. Also suppose that when the third dial is advanced to 8 (reading 5 380), the deflection is 11.8 divisions in the reverse direction, showing that 5 380 is too large. One step on the third dial corresponds to $8.3 + 11.8 = 20.1$ scale divisions of galvanometer deflection. Also one step on the third dial is equivalent to 10 units in the fourth place.

A reading of 5 370 corresponds to a deflection 8.3 scale divisions too small. Therefore, it is necessary to add to the fourth place of that reading $8.3/20.1 \times 10 = 4$ DRRS units; $5\ 370 + 4 = 5\ 374$, the correct DRRS reading.

The interpolated digit equals

$$\frac{\text{Deflection at lower setting of dial}}{\text{Deflection at lower setting} + \text{Reverse deflection at higher setting}}$$

multiplied by 10, the number of units in the interpolated place equivalent to one step on the lowest dial.

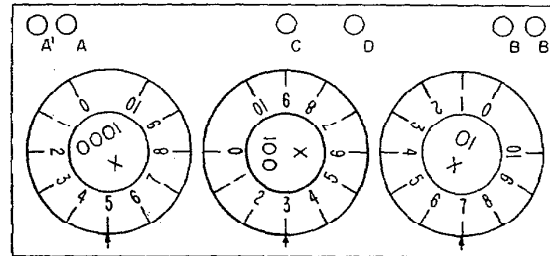

FIGURE 12. Three-dial DRRS.
Interpolation is necessary to give the fourth place.

7.5. Extrapolation

Extrapolation differs from interpolation in that it is used to determine a value outside the range of an instrument scale instead of a value between two scale readings. It may be used to extend the scale at either end, either below zero or beyond the highest reading, by a small amount. Extrapolation is rarely necessary. It is as simple as interpolation, but, nevertheless, may be somewhat puzzling.

The zero of a Mueller bridge may be negative. Suppose that a trial shows that the galvanometer deflections increase to the right as the dial settings of the bridge are increased; that is, the galvanometer is connected to the bridge so that a deflection to the right indicates too much resistance in the bridge circuit. Also, suppose that with all dials on zero, the deflection is 10.5 scale divisions to the right. The lowest dial is then advanced one step, to a reading of 0.0001 ohm. Suppose that the deflection now is 15.7 scale divisions to the right. Then, $15.7 - 10.5 = 5.2$ scale divisions correspond to one step on the lowest dial. Hence the deflection of 10.5 scale divisions when the bridge reads 0.0000 corresponds to $10.5/5.2$ steps on the lowest dial. Since the bridge resistance was too large with all dials on zero, the zero for the bridge is -0.00020 .

(Note: The Mueller bridge has an N circuit and an R circuit. The zero may be negative either or both.)

It is rarely necessary to extrapolate beyond the top reading of an instrument scale. It may be desirable to extrapolate to avoid resetting dials to give a higher reading which would involve changes in dial corrections. This situation is likely to occur with modern precision equipment.

Suppose the galvanometer deflection for the top setting of the dials of an instrument is s_1 , and that the deflection when the lowest dial is back one step is s_2 . Then $s_2 - s_1$ is the deflection which corresponds to one step on the lowest dial, and

$$\frac{s_1}{s_2 - s_1}$$

is the fraction of a step in excess of the highest reading on the dials. Therefore,

$$\frac{s_1}{s_2 - s_1} \times 10$$

is the extrapolated digit.

7.6. Errors Versus Mistakes

7.6.a. Errors

An error is a deviation of measurement from the exact value of the quantity measured. Errors are unavoidable, but are reducible by improvements in equipment and measuring techniques. Mistakes are due to carelessness (that is,

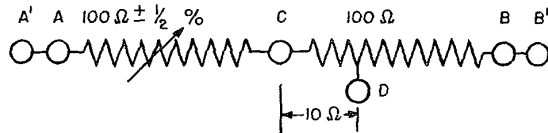

FIGURE 14. Ratio arms of DRRS.

cuit is given in figure 14. The binding posts, A and A', are at the left end of the variable resistor, AC. They are in duplicate so that two connections need not be made to the same binding post. Also, duplicate binding posts are at the right end of the fixed resistor, CB. The end binding posts may be marked as battery posts. Connected to the junction between the variable resistor and the fixed resistor is the binding post, C. It may be labeled G for galvanometer. The AC and the CB arms of the set are used as the ratio arms of a bridge circuit with a ratio of approximately 100:100 which is the same as 1:1. Since, in a Wheatstone bridge, the connections of the galvanometer may be interchanged with those of the battery, C may be used for a battery connection and the galvanometer may be connected to the end posts. In some cases the choice of connections is optional. In others, it is determined by the need to avoid excessive current in some branch of the circuit.

The fixed arm, CB, has a resistance of 100 ohms. The variable arm, AB, has a range from about 99.5 ohms to about 100.5 ohms.

An additional binding post, D in figure 13, if included on the panel, is connected into the CB arm to provide a resistance between C and D of 10 ohms. The use of this binding post instead of

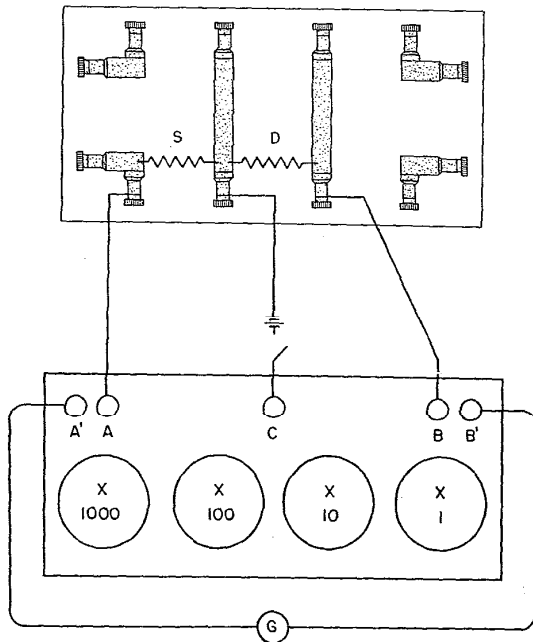

FIGURE 15A. Connection of DRRS for resistance by substitution.

B provides a ratio of approximately 100:10, that is 10:1.

The panels of commercial ratio sets may have switches and additional binding posts. The manufacturer's instructions will identify the different elements of the set. In the absence of instructions, the circuit may be traced with a simple tester (volt-ohm-meter). The discussion to follow will be based on the above diagrams.

The resistance of the variable arm is adjustable by four dial switches (three dial switches for three decades in older sets). The first dial, left, changes the resistance of the arm 0.1 ohm per step. The changes per step of the other dials are, in order, 0.01 ohm, 0.001 ohm, and 0.0001 ohm. Accordingly, the dials on some sets are marked in terms of the change in resistance per step, that is, $\times 0.1$, $\times 0.01$, etc. On other sets, the dials are labeled $\times 1000$, $\times 100$, $\times 10$, and $\times 1$. The latter marking conforms to the use of the set to measure the difference in resistance of two resistors in parts per million of their nominal value. With the older three-dial sets, it is necessary to interpolate to the fourth place for the same precision.

The contact resistance of a dial switch may be of the order of 0.001 ohm. However, any error in measurement with a high-grade Direct Reading Ratio Set due to switch-contact resistance is negligible, due to an ingenious arrangement of the circuit as explained in NBS Circular 470. This circuit arrangement also minimizes effects of errors in the resistance of the coils in the set. The result is that the instrumental error for any reading of the dials need not exceed 5 ppm and the error in the difference of two readings, if the $\times 1000$ dial has not been changed in taking the readings, need not exceed 2 ppm, when comparing nominally equal resistances.

8.2. Resistance by Substitution

Let X be a resistor of unknown value, and S a calibrated resistance standard of the same nominal value as X.

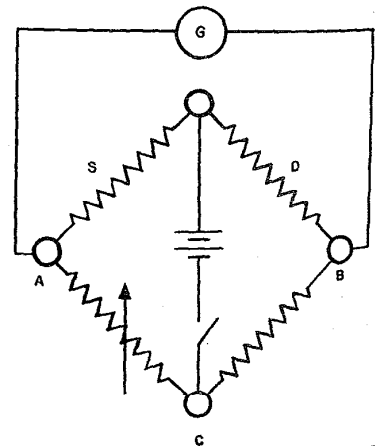

FIGURE 15B. Schematic diagram of figure 15A.

In figure 15A, the letters A'A, C, BB' represent the binding posts of a Direct Reading Ratio Set as in the preceding diagrams. S is the standard mounted on the mercury stand. The "dummy," D is a standard resistor of the same nominal value as S, also mounted on the stand. The dummy is necessary to balance the circuit, but its exact value does not enter into the measurement. The schematic diagram of figure 15B shows that the circuit is a Wheatstone bridge network. With the battery key closed, the bridge is balanced by adjusting the dials on the DRRS until there is no deflection (or minimum deflection) of the sensitive galvanometer. When the bridge is balanced, the reading of the dials of the DRRS is recorded as Rdg₁. The standard is then replaced by the unknown resistor, the bridge is again balanced and the reading of the dials is recorded as Rdg₂.

If c_s is the correction in parts per million to the nominal value of the standard and c_x is the correction to the nominal value of X,

$$c_x = Rdg_2 - Rdg_1 + c_s.$$

All quantities in equations and formulas are used algebraically; hence, attention must be given to algebraic signs.

Note that the resistance of the unknown is not directly measured.

$$Rdg_2 - Rdg_1 = c_x - c_s.$$

This result is the difference in parts per million between the resistance of the unknown and the resistance of the standard.

The method of "resistance by substitution" was used in the following example: X was a "100-ohm" resistor, the exact value of which was unknown. Hence, the nominal values of the dummy and the resistance standard were each 100 ohms. The exact value of the dummy was not needed. The value of the standard was certified as 99.997 ohms, with a probable accuracy of 0.002 percent. Then the correction, c_s , for the standard was -0.003 ohm, or, in proportional parts, $-\frac{0.003}{100} = -0.000030$ of its nominal value or -30 ppm, accurate to 20 ppm.

Reading for X, Rdg ₂	5396
Reading for S, Rdg ₁	5347
Rdg ₂ - Rdg ₁	+49 ppm
Correction for S, c_s	-30 ppm
Correction for X, c_x	+19 ppm

Resistance of X 100.0019 ohms ± 20 ppm.

Resistance of X was reported as 100.002 ohms. An error of 2 percent in the difference of the readings in the above example would result in an error of only one part per million.

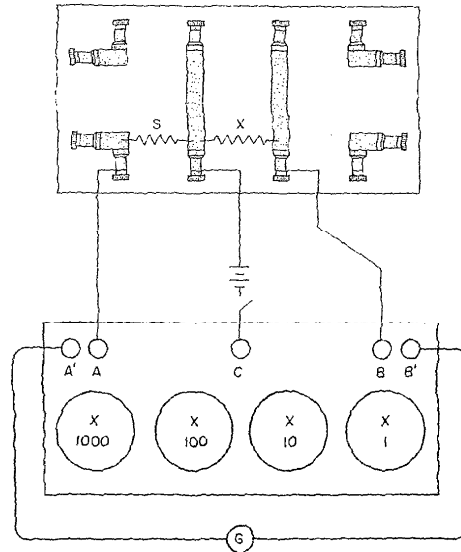

FIGURE 16. DRRS connections for resistance by the interchange method.

in the measured value of X. The accuracy of the method lies in the measurement of small differences of ratios instead of direct measurement of ratios.

S.3. Resistance by the Interchange Method

In figure 16, X is a resistor of unknown value, and S is a standard of the same nominal value. Both are mounted on a mercury stand with connections to a DRRS as shown. Let Rdg₁ be the reading of the dials of the ratio set when S is on the left. After the positions of S and X are interchanged, Rdg₂ is taken. If c_s and c_x are the corrections in parts per million for the standard and the unknown, respectively,

$$c_x = \frac{Rdg_2 - Rdg_1}{2} + c_s.$$

This method is satisfactory if the standard and the unknown do not differ by more than 0.1 percent.

Example: X is an unknown of approximately 1 000 ohms resistance; S is a 1 000-ohm standard with a correction of +87 ppm. Rdg₁ = 5 476; Rdg₂ = 4 898.

$$c_x = \frac{4\ 898 - 5\ 476}{2} + 87 = -202 \text{ ppm.}$$

202 ppm of 1 000 ohms = 0.000202 × 1 000 = 0.202 ohm.

X = 1 000.000 - 0.202 = 999.798 ohms. The result is rounded off to X = 999.80 ohms.

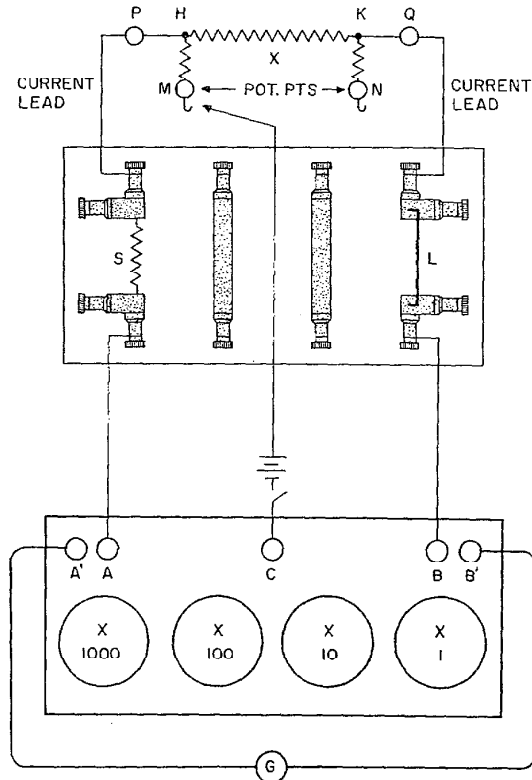

FIGURE 17. Four-terminal measurement with the DRRS.

8.4. Comparison of a Four-Terminal Resistor with a Two-Terminal Resistor

This method is important in testing laboratory apparatus in which two of the connections to a four-terminal resistor can be made only through other resistors.

In Figure 17, let X be a resistor, the terminals H and K of which are not available for external connections. The available terminals are the binding posts P , Q , M , and N . Hence, X is a four-terminal resistor. Current leads are taken to the binding posts P and Q , potential leads go to the binding posts M and N . The potential leads may pass through considerable resistance. The terminals H and K of the resistor X , are the junction points of current leads and potential leads. The resistance is measured between these junctions.

S and L , on a mercury stand, are respectively a standard resistor of the same nominal value as X and a link.

With S on the left of the stand, L on the right, and the battery lead clipped to the potential point, M , Rdg_1 is taken on the DRRS. After exchanging places between the standard and the link and clipping the battery lead to N , Rdg_2 is taken. If c_s and c_x are the respective corrections to the nominal values of the standard and the unknown, and L is

the resistance of the link expressed in parts per million of the same nominal value,

$$c_x = \frac{Rdg_2 - Rdg_1}{2} + c_s - L.$$

Unless the resistance of the link is quite large (10 microhms or more), the last term in the preceding equation is usually negligible for nominal value of X in excess of 10 ohms.

Example: Nominal value of unknown 100 ohm
 Nominal value of standard 100 ohm
 Correction for standard -35 ppm
 DRRS, Rdg_1 5485
 Rdg_2 5453

In this case, the correction for the link is negligible.

$$c_x = \frac{5453 - 5485}{2} + (-35) = -51 \text{ ppm}$$

51 ppm of 100 ohms = $0.000051 \times 100 = 0.0051$ oh

$$X = 100.0000 - 0.0051 = 99.9949 \text{ ohms.}$$

in general, the last digit may be considered uncertain, hence the reported value is **99.995 ohms**.

As noted above, the correction for the link, in the above equation, is in parts per million of the resistor with which it is used. If the resistance of the link is 40 microhms, it is 40 ppm of 1 ohm, 4 ppm of 10 ohms, and a negligible 0.4 ppm 100 ohms.

8.5. Approximate Measurement of a Small Resistor

A resistance element of very small value may be measured approximately with the Direct Reading Ratio Set in the circuit of figure 18. Two standards, S , S , of the same nominal value, are mounted on the stand, one on each side of the unknown. If X is a resistor that can not be mounted on the middle blocks of the stand, it is connected to the binding posts by the shortest possible leads. Potential points are taken at a and b as shown in the diagram, and current leads from the ratio set go to the outer terminals of the standards. Readings are taken on the DRRS with the potential lead first at a , then at b .

$$X = \frac{Rdg_2 - Rdg_1}{2} S$$

$(Rdg_2 - Rdg_1)/2$ is in parts per million

The least value of the standards is limited by the resistance of X , which should not exceed 0.25 percent of the value of the standards. The method is approximate but sufficient for the small resistances for which it is used.

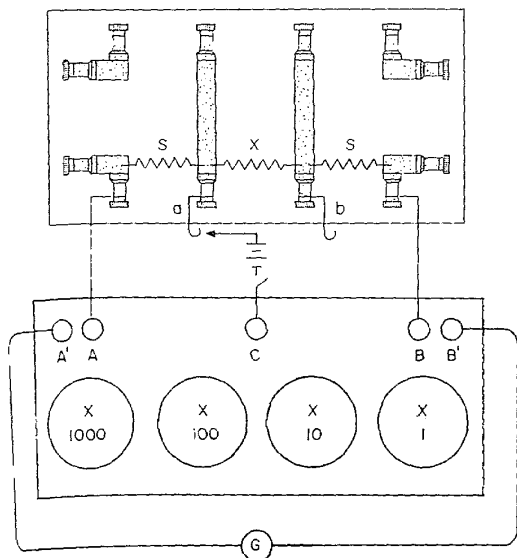

FIGURE 18. Measurement of a small resistance with the DRRS.

used. S in the above equation is the *nominal* value of the standards.

The following examples will illustrate some applications of the method:

(1) To find the resistance of a shorting link. The resistance of the link described in section 5 is less than 0.25 percent of 1 ohm (less than 0.0025 ohm). Hence, 1-ohm standards should be used. Readings taken with a similar link were:

1st reading, Rdg_1 5 438
 2d reading, Rdg_2 5 514

$$\frac{5\ 514 - 5\ 438}{2} = 38$$

$$38 \text{ ppm} = 0.000038 \times 1 \text{ ohm} = 0.000038 \text{ ohm} = 38 \text{ microhms.}$$

(2) To find the lead and contact resistance of the rheostat arm of a Wheatstone bridge. This resistance will probably exceed 0.005 ohm, which is greater than 0.25 percent of 1 ohm, but less than 0.25 percent of 10 ohms. Ten-ohm standards were used to obtain the following readings on a DRRS for the lead and contact resistance of the rheostat arm of a Wheatstone bridge:

Rdg_1 4 224
 Rdg_2 5 617

$$\frac{5\ 617 - 4\ 224}{2} = 696 \text{ ppm}$$

$$0.000696 \times 10 \text{ ohms} = 0.00696 \text{ ohm}$$

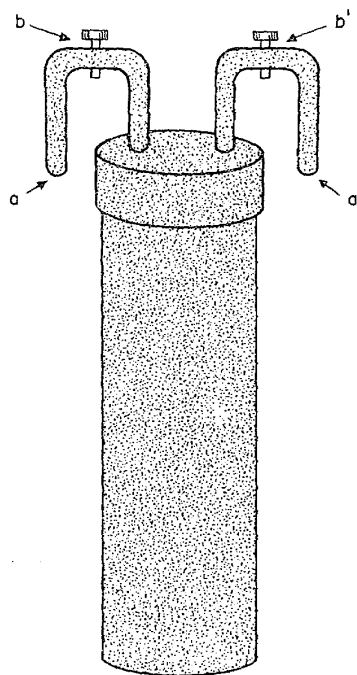

FIGURE 19A. Four-terminal one-ohm standard.

8.6. Determination of the Two-Terminal Resistance of a 1-Ohm Standard When Its Four-Terminal Value Is Known

The NBS certificate usually gives only the four-terminal value of a 1-ohm standard. In some resistances measurements, the two-terminal value is required. When the four-terminal resistance is known, the two-terminal value can be determined readily with the Direct Reading Ratio Set.

In figure 19A, the plane contact surfaces of the resistor arms which rest on the mercury stand are designated a, a' , and the binding posts at the top of the arms, b, b' . The standard which is to be tested is mounted on the middle blocks of the stand with another 1-ohm standard (a dummy) on the left and a link on the right, figure 19B. Short tabs of bare copper wire are connected to the binding posts of the stand as shown at a, a' . Similar tabs are connected to the binding posts of the standard at b, b' . These are the potential points for connection of an alligator clip at the end of the battery lead. Current leads extend from the end posts, A, B , of the ratio set to the end posts of the stand. The galvanometer leads also are connected to the end posts of the ratio set.

With the battery clip at a , then at b , readings taken on the DRRS are designated Rdg_a and Rdg_b . Then, with the dummy transferred to the right of the stand and the link to the left, readings Rdg_a' and Rdg_b' are taken with the clip at a' ,

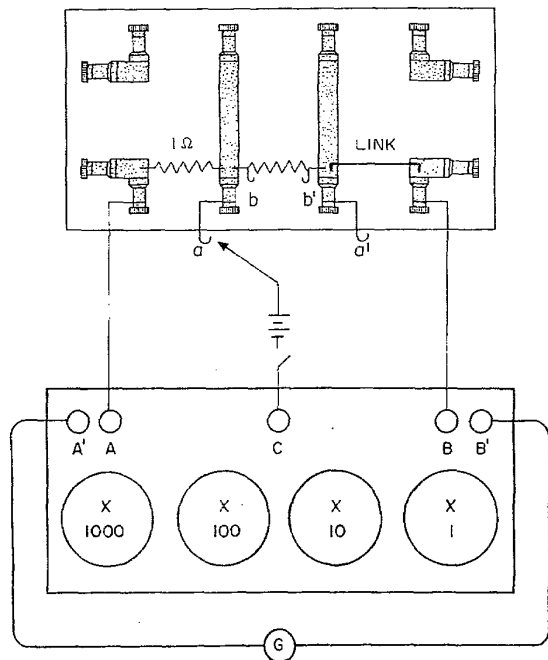

FIGURE 19B. Measurement of two-terminal value of one-ohm standard.

then at b' . The amount to be added to the four-terminal resistance to get the two-terminal value is

$$\frac{Rdg_b - Rdg_a}{2} + \frac{Rdg_{a'} - Rdg_{b'}}{2} \text{ ppm.}$$

The resistance of the dummy and the resistance of the link do not enter into the computation. And, of course, either standard resistor may be used for comparison to find the two-terminal value of the other.

Example: The four-terminal correction for a 1-ohm standard was -54 ppm, hence, its four-terminal resistance was 0.999946 ohm. The DRRS readings obtained by the preceding procedure were:

<i>Dummy on the left</i>		<i>Dummy on the right</i>	
a	5 772	a'	5 847
b	5 814	b'	5 801

Substitution of the readings in the above equation gives

$$\frac{5\ 814 - 5\ 772}{2} + \frac{5\ 847 - 5\ 801}{2} = 21 + 23 = +44 \text{ ppm.}$$

Hence, the two-terminal value of the resistor was

$$0.999946 + 0.000044 = 0.999990 \text{ ohm,}$$

and the two-terminal correction was $-54 + 44 = -10$ ppm.

9. Measurement of "Odd-Valued" Resistors

9.1. "Odd Values" Distinguished From Values of Conventional Standards

The term "odd-valued," as used here, includes those resistors which are not decimal multiples or submultiples of 1 ohm. Some examples are resistors with denominations of 2 ohms, 5 ohms, 20 ohms, 50 ohms, etc. A similar set of resistance values is found in some types of resistance boxes. Other denominations occur, either separately, or as components of laboratory apparatus.

Most of these odd values can be measured at a one-to-one ratio on the Direct Reading Ratio Set by use of combination standards consisting of two or more conventional standards connected to produce the required resistance. The correction in parts per million of the nominal value of any combination standard may be derived readily from the corrections of its components.

9.2. Combinations of Resistors

Resistors may be connected in series, in parallel, or in combination of series and parallel. The notation $R(1+c)$ which was explained in section 2, will be used in the following discussion to express the true value of a resistor in terms of its nominal value, R , and its correction, c in parts per million of its nominal value.

9.2.a. Resistors of the Same Nominal Value in Series

If n resistors, $r_1, r_2, r_3, \dots, r_n$ are in series, the total resistance is

$$R = r_1 + r_2 + r_3 + \dots + r_n.$$

If these resistors have *exactly* the same value, the series resistance is

$$R = nr.$$

In general, no two resistors have exactly the same value. Suppose n resistors have the same nominal value, r , with corrections in parts per million of the nominal value, $c_1, c_2, c_3, \dots, c_n$, respectively. Then the equation for the series resistance is

$$R = r(1+c_1) + r(1+c_2) + r(1+c_3) + \dots + r(1+c_n) \\ = nr \left(1 + \frac{c_1 + c_2 + c_3 + \dots + c_n}{n} \right).$$

In the equation, nr is the nominal value of series resistance, and $(c_1 + c_2 + c_3 + \dots + c_n)/n$ is the correction to that nominal value.

Hence, if resistors of the same nominal value in series, the nominal value of the series resistance is equal to the nominal value of one component resistor multiplied by the number of resistors in series.

and the correction in parts per million of the resistance is the arithmetical mean of the corrections of the components in the series.

EXAMPLE: Three resistors, each of 100 ohms nominal value, are in series. Their corrections in parts per million of the nominal value are +45, +7, and -10 respectively. Find the series resistance.

The nominal value of the series resistance is $3 \times 100 = 300$ ohms.

The correction in parts per million of the nominal value is the arithmetical mean of the corrections of the components of the series, which is

$$\frac{(+45) + (-7) + (-10)}{3} = +9.$$

Hence, the series resistance is $300(1+9 \text{ ppm}) = 300 \times 1.000009 = 300.0027$ ohms.

To illustrate the application of the correction to a series resistance in the measurement of an unknown, the above resistors in series were used as a combination standard for measurement of a 300-ohm resistance coil in a Kelvin Ratio Box. The bridge circuit was set up with a Direct Reading Ratio Set as ratio arms as explained for resistance interchange method in section 8.3. The standards in series formed one upper arm of the bridge, and the 300-ohm coil, connected through binding posts of the box, formed the other upper arm. After the bridge was balanced a reading taken on the DRRS, the positions of the standards and the unknown were interchanged, the bridge was balanced and a second reading taken. The readings were:

Standard on the left, Rdg₁ 5 315
 Standard on the right, Rdg₂ 5 437
 Correction for the standard, c_s +9 ppm

Substituting these values in the equation for resistance by the interchange method gives

$$\frac{\text{Rdg}_2 - \text{Rdg}_1}{2} + c_s = \frac{5437 - 5315}{2} + 9 = +70 \text{ ppm.}$$

$$300(1+70 \text{ ppm}) = 300 \times 1.000070 = 300.0210 \text{ ohms.}$$

The result was rounded off to report $X = 300.021$

If the measurement had been made by simple substitution, (sec. 8.2), a dummy would have been necessary requiring another 300-ohm resistor (or 100-ohm resistors in series).

b. Resistors of the Same Nominal Value in Parallel

The equation for n resistors in parallel is

$$\frac{1}{R} = \frac{1}{r_1} + \frac{1}{r_2} + \frac{1}{r_3} + \dots + \frac{1}{r_n}$$

If the resistance of each component is exactly r ,

the equation becomes

$$\frac{1}{R} = \frac{n}{r}, \text{ and } R = \frac{r}{n}$$

Since the components with the same nominal value will have different corrections, the corrected equation for parallel resistance is

$$\frac{1}{R} = \frac{1}{r(1+c_1)} + \frac{1}{r(1+c_2)} + \frac{1}{r(1+c_3)} + \dots + \frac{1}{r(1+c_n)}$$

An expression of the form $\frac{1}{1+c}$, when expanded, becomes

$$\frac{1}{1+c} = 1 - c + c^2 - c^3 + \dots \text{ etc.}$$

If c is less than 0.001, the second-order term, c^2 , is less than 0.000001, the third-order term, c^3 , is less than 0.000000001, etc. If c is small, the higher the order, the less significant the term.

If terms of the second and higher orders are negligible, the above equation may be reduced to the following approximate form which is generally accurate for application to standard resistors and their corrections:

$$R = \frac{r}{n} \left(1 + \frac{c_1 + c_2 + c_3 + \dots + c_n}{n} \right)$$

(See sec. 7.2.) In the equation for R , $\frac{r}{n}$ is the nominal value of the parallel combination, $\frac{c_1 + c_2 + c_3 + \dots + c_n}{n}$ is the correction to that nominal value.

If resistors of the same nominal value are connected in parallel, the nominal value of the parallel resistance is equal to the nominal value of one resistor divided by the number of resistors in parallel, and (assuming that second order terms are negligible) the correction in parts per million of the nominal value of the parallel resistance is equal to the arithmetical mean of the corrections to the components in parallel.

It follows that n resistors of the same nominal value have the same proportional correction, whether they are connected in series or in parallel if, as stated above, the second-order terms are negligible. The nominal value with the resistors in series is n^2 times the nominal value with the resistors in parallel.

Example: The preceding principles may be illustrated by application to the measurement of a resistor which has a nominal value of 250 ohms. Four 1,000-ohm standards may be used in parallel as a 250-ohm standard. If these standards have corrections, respectively, of +76, -125, -16, and +29 ppm, the correction to the 250-ohm parallel combination is the arithmetical mean of the four individual corrections, which is -9 ppm. Assume

that the following data are obtained by use of the above combination of resistors as a 250-ohm standard for the measurement of the unknown by the interchange method:

Correction for standard, c_s -9 ppm
 Standard on the left, Rd_1 5 398
 Standard on the right, Rd_2 5 220

$$c_x = \frac{5\ 220 - 5\ 398}{2} - 9 = -98 \text{ ppm}$$

$$X = 250(1 - 98 \text{ ppm}) = 250 \times 0.999902 = 249.976 \text{ ohms.}$$

9.2.c. Resistors of Different Nominal Values in Series

For illustration, consider a 100-ohm resistor and two 10-ohm resistors in series to produce a nominal resistance of 120 ohms (fig. 20). Suppose that the corrections to the nominal values of these resistors are +35, +27, and -65 ppm respectively. The 100-ohm resistor may be considered equivalent to ten 10-ohm resistors in series, each with the same correction, +35 ppm. The complete series is equivalent to twelve 10-ohm resistors. The sum of the twelve corresponding corrections is:

$$(10 \times 35) + 27 - 65 = +312.$$

This sum divided by 12 (number of equivalent 10-ohm resistors) gives +26 ppm, the correction to the nominal value of the series. Hence,

$$R = 120(1 + 26 \text{ ppm}) = 120 \times 1.000026 = 120.0031 \text{ ohms.}$$

The correction (+26 ppm) in the above example is the "weighted mean" of the corrections of the three resistors in the series. Since the resistors are not of the same nominal value, the average of the three corrections would not be correct. Evidently, the 100-ohm resistor has ten times the "weight" of each of the other resistors. To find the weighted mean of the corrections to several resistors, divide the nominal value of each by the least nominal value in the group. These quotients are the "relative weights" of the corresponding corrections. Multiply each correction by its relative weight. Divide the algebraic sum of the products by the sum of the relative weights.

The correction in parts per million of the nominal resistance of any number of resistors of different nominal values in series is the *weighted mean* of the several resistor corrections.

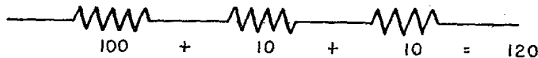

FIGURE 20. Resistors in series.

9.2.d. Resistors of Different Nominal Values in Parallel

Although this case rarely, if ever, occurs in practical testing, a complete discussion requires its inclusion. There is no simple expression for the resistance of a combination of this type. If the resistors of the preceding example are connected in parallel, the resistance of the group must be found from the following relation:

$$\frac{1}{R} = \frac{1}{100.0035} + \frac{1}{10.00028} + \frac{1}{9.99935}$$

This equation gives $1/R = 0.210003$, and

$$R = 4.76183 \text{ ohms.}$$

This result can not be satisfactorily expressed in terms of a nominal value and its correction.

9.2.e. Resistors in Series and in Parallel

A nominal resistance of 125 ohms may be produced by connecting eight 1 000-ohm resistors in parallel. The same result is obtained with five resistors in series-parallel as shown in figure 21. The inclusion of the last two 10-ohm resistors between vertical bars in the equation indicates that they are in parallel, equivalent to one 5-ohm resistor. The parallel group is in series with the other resistors, so that the entire combination amounts to $100 + 10 + 10 + 5 = 125$ ohms nominal, and it is equivalent to

$$20 \times 5 + 2 \times 5 + 2 \times 5 + 1 \times 5,$$

or twenty-five 5-ohm resistors in series. Suppose that the corrections, in the order in which the resistors are listed, are +20, +30, +40, and +50 ppm. Since the last two resistors are in parallel, equivalent to one 5-ohm resistor, the correction in parts per million of 5 ohms is $(50 + 70) \div 2 = +60$. The next step is to find the weighted mean.

$$\begin{array}{r} (+20) \times 20 = +400 \\ (+30) \times 2 = +60 \\ (+40) \times 2 = +80 \\ (+60) \times 1 = +60 \\ \hline 25 \overline{) 600} \\ + 24 \\ \hline \end{array}$$

Hence, the correction for this combination of resistors is +24 ppm of its nominal value of 125 ohms. The total resistance is

$$125(1 + 24 \text{ ppm}) = 125 \times 1.000024 = 125.0030 \text{ ohms.}$$

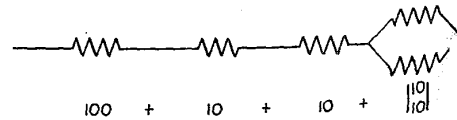

FIGURE 21. Resistors in series and in parallel.

9.3. Adaptation of the Direct Reading Ratio Set for Ratios of $1:n$ and $m:n$

In using the Direct Reading Ratio Set it is usually best to set up the bridge to use a substitution method. For example, to measure a 300-ohm resistor the 100:100 arms of the ratio set would be used, and a Wheatstone bridge would be set up and balanced using a 300-ohm auxiliary on the right and the unknown 300-ohm resistor on the left. After balance, the unknown would be replaced by three 100-ohm standards connected in series on the mercury stand, and a second balance obtained. The difference in readings would then be the difference in parts per million between the unknown and the sum of the resistances of the three 100-ohm standard resistors. However, if three calibrated 100-ohm standards are not available, the ratio set circuit may be modified to give a 1:3 ratio and the 300-ohm unknown measured against a single calibrated 100-ohm standard. It is also possible to adapt the circuit to measure the 300-ohm unknown against two 100-ohm standards, or by setting up a 3:5 ratio, in terms of two 1 000-ohm standards in parallel.

9.3.a. Typical Adaptations

Some commercial ratio sets have a connection for a fixed arm of 10 ohms, affording a ratio of 1:1. A variety of other DRRS ratios may be formed, as 1:2, 1:3, . . . 1:10, or 2:3, 3:4, etc. Figure 22 illustrates an adaptation for a ratio 1:2. A 100-ohm standard is connected to binding post, B'. The right hand terminal of the set becomes F, the fixed arm CF, and the ratio of AC to CF is 100:200.

A ratio of 1:10 may be formed as in figure 23. A 1000-ohm standard connected to the middle post, of the DRRS forms the fixed arm, CF, of the bridge and the ratio of AC to CF is 100:1 000.

A ratio of 1:1.5, or 2:3, can be formed as in figure 24. Two 100-ohm standards in parallel provide a supplementary resistance of 50 ohms, which added to the CB arm of the DRRS, makes the fixed arm, CF, of the modified set equal to 150 ohms and the ratio of AC to CF 100:150.

A ratio of $m:n$, in which m and n are both integers, may be provided by using supplementary standards to make the right arm of the set equal to m times n/m .

The resistance of leads used in making connections should be insignificantly small.

9.3.b. Bridge Zero

The arm of the ratio set is adjustable so that the ratio of the arms is variable from about 0.5 percent below to about 0.5 percent above the nominal $m:n$. At some setting of the dials, the ratio is exactly $m:n$. Call this setting "bridge zero" and designate it by "Rdg₀."

The DRRS has been adapted to a ratio of $m:n$. In addition of resistors to the fixed arm (or to the middle binding post), a bridge is set up by

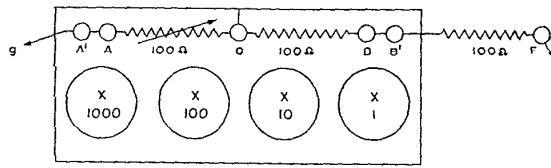

FIGURE 22. Adaptation of DRRS for 1:2 ratio.

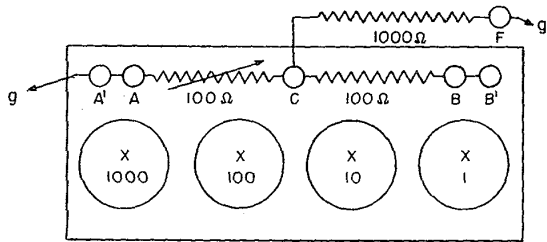

FIGURE 23. Adaptation of DRRS for 1:10 ratio.

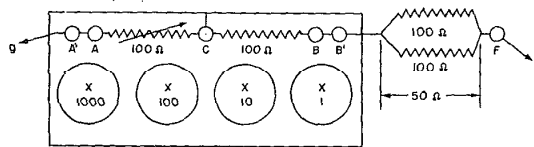

FIGURE 24. Adaptation of DRRS for 2:3 ratio.

using $m+n$ standards each of the same nominal value, in the upper arms, m standards on the left and n standards on the right. The value of these should be large enough to make lead and contact resistance negligible. With the standards in a definite pattern, they may be rotated step by step, until each resistor has occupied each position in the pattern. At each step, a reading is taken on the dials, from Rdg₁ to Rdg _{$m+n$} . Bridge zero is the arithmetical mean of the $m+n$ readings taken.

$$Rdg_0 = \frac{Rdg_1 + Rdg_2 + Rdg_3 + \dots + Rdg_{m+n}}{m+n}$$

This number is independent of the corrections to the nominal values of the standards used if each is less than 1 000 ppm. It applies equally well to standards in series or in parallel.

Unless the resistances of the leads to the upper arms of the bridge are negligible, the resistances of the leads must also be in the ratio $m:n$. The leads may be adjusted to the correct ratio by shorting each arm and balancing the bridge by adjusting the leads.

It is not always necessary to use $m+n$ standards to form a ratio of $m:n$. By a combination of series and parallel connections, the number of required standards may be reduced. A ratio of 2:3 may be obtained with four standards instead of five. A ratio of 1:10 may be obtained with seven standards instead of eleven.

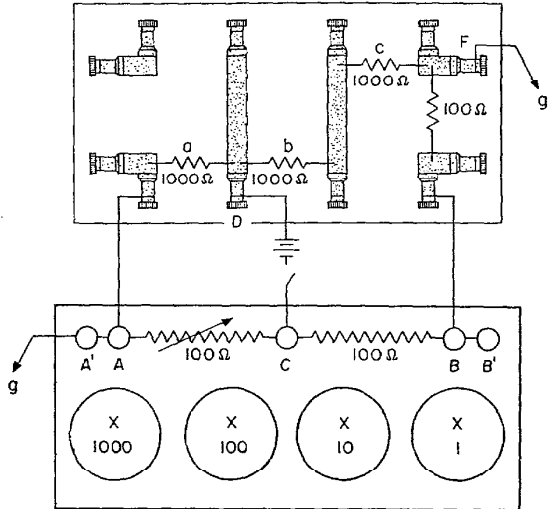

FIGURE 25A. Assembly to find R_0 for a 1:2 ratio.

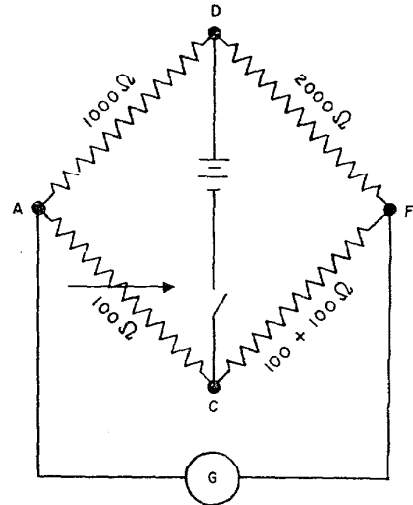

FIGURE 25B. Schematic representation of figure 25A.

9.3.c. Application of Above Procedures to Measurement of Odd Values

The following examples are intended to clarify the preceding explanations.

Example 1: It is required to find the true value of a resistor which has a nominal value of 20 000 ohms.

With the ratio set adapted to a ratio of 1:2, a Wheatstone bridge is completed by using three 1 000-ohm standards (or 100-ohm standards) in the upper arms, one on the left and two in series on the right.

To reduce the number of binding post connections, the standard resistors can be mounted on a mercury stand. In figure 25A, the 100-ohm resistor on the right-hand end of the stand is in series with the 100-ohm resistor, CB. The resistance from C to F (200 ohms) constitutes the fixed arm of the DRRS, giving a ratio of 1:2. Note that the lead to the galvanometer is taken from F, not from B'.

The standard resistors a, b, and c form the upper arms of the bridge with a in the left upper arm and b plus c in the right upper arm, also in a ratio of 1:2. Compare figure 25A with figure 25B.

After Rdg_1 is taken on the DRRS with the resistors in the position shown, the resistors a, b, and c are rotated as follows: Resistor b is moved to position a, c to position b, a to position c, and Rdg_2 is taken. (The same result will be obtained by interchanging a and b. However, if several resistors are involved mistakes may be avoided by following a definite plan of rotation.) Then resistor c is moved to position a, a to position b, b to position c, and Rdg_3 is taken.

The rotation of the resistors and the corresponding readings are shown in condensed form in the

following table:

a: (b + c)	$Rdg_1 = 5\ 387$
b: (c + a)	$Rdg_2 = 5\ 491$
c: (a + b)	$Rdg_3 = \frac{5\ 421}{3} = 1\ 807$
	$Rdg_0 = 5\ 433$

The reading 5 433 designated above as bridge zero is the reading of the dials of the DRRS which makes the resistance ratio AC:CF exactly 1:2.

Unless the resistances of the leads are negligible, they should be adjusted to a ratio of 1:2 (approximately) before determining the bridge zero.

The standards in the upper arms of the bridge are now replaced by a 10 000-ohm standard on the left and the unknown (20 000 ohms, nominal) on the right. After the bridge is balanced the dials are read giving (say) $Rdg_x = 5\ 425$. If the correction for the 10 000-ohm standard is $c_s = -83$ ppm, the correction, c_x , for the unknown is found by substituting the numerical values in the following equation:

$$c_x = Rdg_0 - Rdg_x + c_s$$

Hence,

$$c_x = 5\ 433 - 5\ 425 - 83 = -75 \text{ ppm}$$

and $X = 20\ 000(1 - 75 \text{ ppm}) = 20\ 000 \times 0.999925 = 19\ 998.5$ ohms. The value of c_x is negative, but is used with its algebraic sign in the equation for X .

Example 2: To calibrate a resistor with a nominal value of 100 000 ohms. The ratio adapted to a ratio of 1:10. Instead of using standards in the upper arms of the bridge to a ratio of 1:10 to find Rdg_0 , seven standards connected to form the same ratio (50:500) shown in the simplified diagram of figure

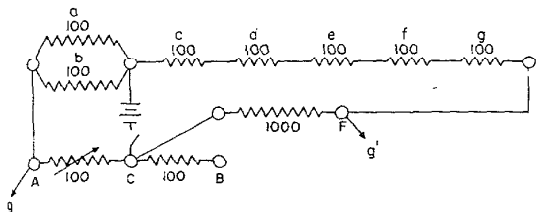

FIGURE 26A. Schematic diagram for 1:10 ratio with seven standards.

Note that, instead of the 100-ohm standards shown in the diagram, 1 000-ohm standards could be used, forming the ratio 500:5 000. The arrangement of the seven standards on two mercury stands, connected by a link (L) to form the upper arms of a bridge, is shown in figure 26B. Resistors a and b, in parallel, form the left upper arm of 50 ohms. Resistors c, d, e, f, and g, in series, form the right upper arm of 500 ohms.

The fixed arm of the DRRS is replaced by the 1 000-ohm standard connected to C and mounted on the right end of the stand to give the DRRS a ratio of 1:10. The galvanometer leads (g, g') are taken from A' and F'.

By comparison with the schematic diagram, figure 26C, it is clear that the circuit is a Wheatstone bridge circuit with arms in a ratio of 1:10.

To find bridge zero, Rd_{g_0} , readings on the DRRS are taken for each sequence as the standards are rotated in the pattern,

$$\begin{aligned} \left\{ \begin{array}{l} a \\ b \end{array} \right\} &: (c+d+e+f+g), \quad \left\{ \begin{array}{l} b \\ c \end{array} \right\} : (d+e+f+g+a), \\ \left\{ \begin{array}{l} c \\ d \end{array} \right\} &: (e+f+g+a+b), \quad \left\{ \begin{array}{l} d \\ e \end{array} \right\} : (f+g+a+b+c), \\ \left\{ \begin{array}{l} e \\ f \end{array} \right\} &: (g+a+b+c+d), \quad \left\{ \begin{array}{l} f \\ g \end{array} \right\} : (a+b+c+d+e), \\ \left\{ \begin{array}{l} g \\ a \end{array} \right\} &: (b+c+d+e+f). \end{aligned}$$

Rd_{g_0} is the arithmetical mean of the seven readings.

The measurement of the unknown follows the procedure described in the preceding example. Rd_x is taken with a 10 000-ohm standard in the left upper arm of the bridge and the unknown 100 000-ohm in the right arm. As in example 1,

$$c_x = Rd_{g_0} - Rd_x + c_s.$$

Example 3: To measure a 250-ohm (nominal value) resistor with a 1:4 ratio. The measurement of this resistor at a 1:1 ratio using four 1,000-ohm resistors in parallel as a combination standard was explained in section 9.2b. The addition of three 100-ohm resistors in series to the fixed arm of the DRRS changes the set to a ratio of 100:400. With the modified ratio in the lower arms of the bridge, bridge zero may be determined by use of four 100-ohm standards in the upper arms, two in parallel on the left, two in series on the right, to form a ratio of 50:200.

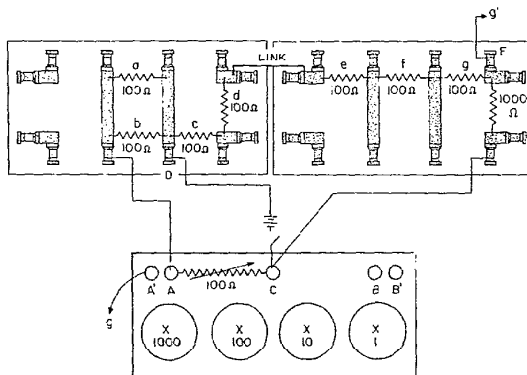

FIGURE 26B. DRRS connected to seven standards on stands for 1:10 ratio.

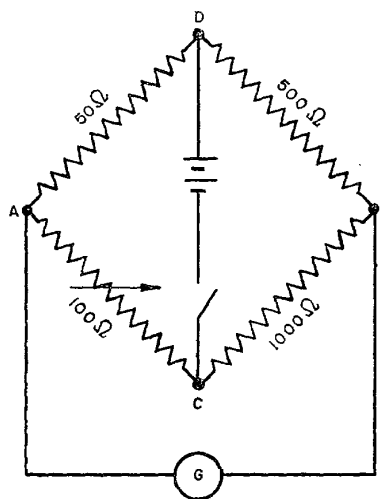

FIGURE 26C. Simplified representation of figure 26A.

Figure 27A shows how the standards may be mounted on two mercury stands connected by a link, L. The arrangement of the stands permits reasonably short leads from the A and B binding posts of the DRRS to the stands. The three 100-ohm resistors on the right hand stand are in series with the 100-ohm fixed resistor, CB, of the DRRS, making the fixed-resistance arm, CF, 400 ohms and the ratio, 100:400 or 1:4. The galvanometer leads (g, g') are connected to A' and F'.

On the left hand stand, the 100-ohm resistors, a and b, are in parallel to make the left upper arm of the bridge 50 ohms. The resistors, c and d, are in series to produce a resistance of 200 ohms in the right upper arm of the bridge. The ratio of the upper arms is 50:200 or 1:4.

After Rd_{g_0} has been found, as previously explained, the standards a, b, c, and d are removed from the stand and a 1 000-ohm standard is mounted between H and D. If the 250-ohm unknown cannot be mounted on the stand between

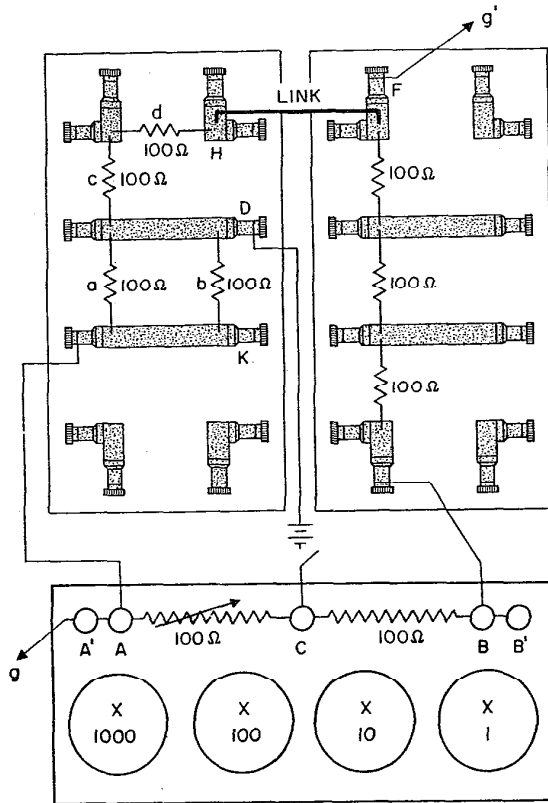

FIGURE 27A. Arrangement of standards to determine "bridge zero" with a ratio of 1:4.

D and K, it is connected by short leads to the binding posts of the respective bars of the stand. A schematic diagram of the Wheatstone bridge circuit with the 100-ohm standards on the left-hand stand replaced by the unknown and the 1 000-ohm standard is shown in figure 27B.

After the bridge is balanced, Rdg_x is taken on the DRRS. Note that in the preceding examples, the standard was in the left upper arm of the bridge, the unknown in the right arm. Since, in this case the positions of S and X in the upper arms has been interchanged, there will be a corresponding interchange of the algebraic signs of Rdg_0 and Rdg_x in the equation for c_x . The equation is

$$c_x = Rdg_x - Rdg_0 + c_s.$$

From the following data:

$$\begin{aligned} S &= 1\ 000 \text{ ohms} \\ c_s &= +75 \text{ ppm} \\ Rdg_0 &= 5\ 520 \\ Rdg_x &= 5\ 347 \\ c_x &= 5\ 347 - 5\ 520 + 75 = -98 \text{ ppm} \end{aligned}$$

and

$$X = 250(1 - 98 \text{ ppm}) = 250 \times 0.999902 = 249.976 \text{ ohms.}$$

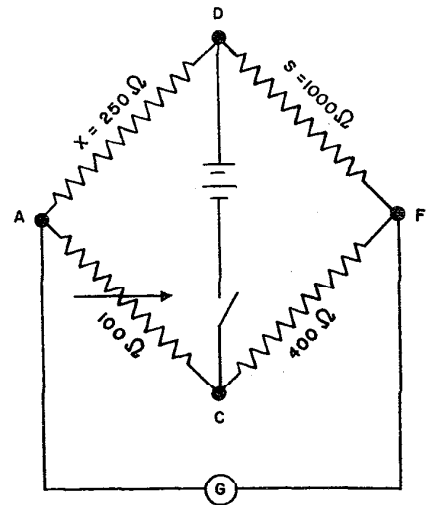

FIGURE 27B. Schematic circuit with the unknown, X, the standard, S.

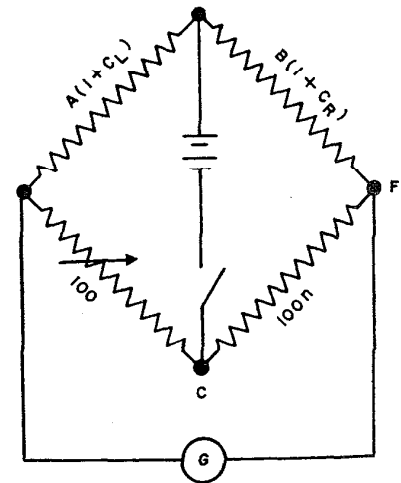

FIGURE 28. Schematic diagram, ratio 1:n.

It is important to avoid confusing the two equations or c_x . If the standard is on the left

$$c_x = Rdg_0 - Rdg_x + c_s.$$

If the standard is on the right

$$c_x = Rdg_x - Rdg_0 + c_s.$$

9.3.d. Determination of Bridge Zero With Two Standards and Corrections

Figure 28 shows schematically a bridge with ratio set adapted to a ratio of 1:n. In the arms of the bridge are two standard resistors with nominal values of A and B, also in the ratio 1:n. c_L is the correction to the nominal value of A.

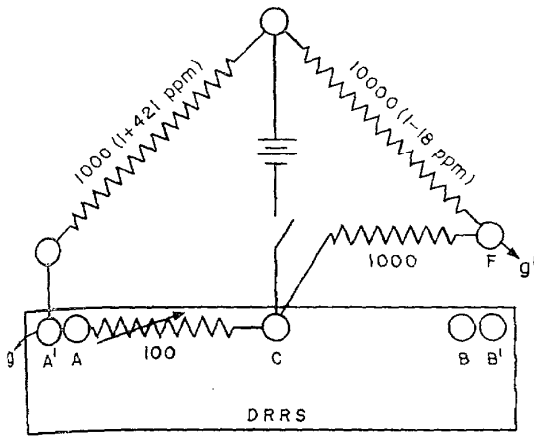

FIGURE 29A. R_0 with two standards, ratio 1:10.

standard on the left, and c_R is the correction to the nominal value of B , the standard on the right, both in parts per million. If Rdg is the reading on the dials with the bridge balanced, bridge zero equals the reading of the ratio set minus the correction to the resistor on the left plus the correction to the resistor on the right. $Rdg_0 = Rdg - c_L + c_R$. The next step is to replace the standards used to find the zero reading on the bridge by the unknown, X , and a standard resistor, S . The value of the standard selected must be such that with S on the left and X on the right, or vice versa, the ratio of the upper arms is the same as the ratio of the lower arms of the bridge. The bridge is balanced and read. If the unknown is on the left, by transposing the above equation, its correction is

$$c_L = Rdg - Rdg_0 + c_R.$$

If the unknown is on the right, by transposing the equation, its correction is

$$c_R = Rdg_0 - Rdg + c_L.$$

Example: To measure a resistor with a nominal value of 150 000 ohms. The Ratio Set is adapted to a ratio of 1:10 by connecting a 1 000-ohm standard to the middle post, C, of the DRRS, figures 29A and B.

The galvanometer leads (g, g') are connected to A' and F. To calibrate a resistor of this value, a 1 000-ohm standard with a correction of +421 ppm was used in the left upper arm of the bridge and a 10 000-ohm standard with a correction -18 ppm in the right upper arm, figure 29A. The bridge reading was 6 173. Hence, bridge zero:

$$Rdg_0 = 6\ 173 - 421 - 18 = 5\ 734.$$

Measurement of X : The 150 000-ohm unknown was connected into the right upper arm of the bridge, figure 29B. For a 15 000-ohm standard

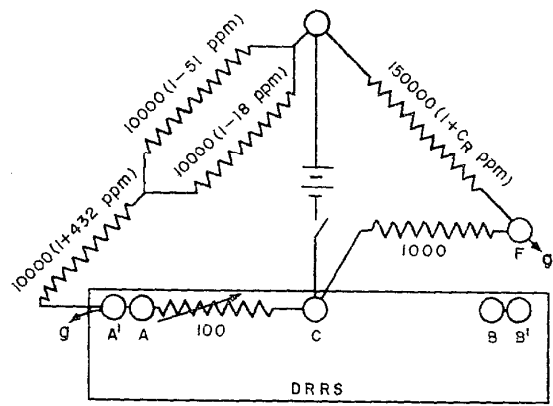

FIGURE 29B. Application to calibration 150,000 ohms nominal value.

in the left arm, to make the ratio of the upper arms 1:10, three 10 000-ohm standards in the series-parallel connection shown in the figure were used. With the bridge set up in this way the reading was 6 321.

Using the corrections to the standards, as shown in the diagram, the "correction on the left" was

$$c_L = \frac{1}{3} \left(2 \times 432 + \frac{-51 - 18}{2} \right) = +277 \text{ ppm. (sec. 9.2.e)}$$

Then the correction for the unknown, "correction on the right," was

$$c_R = 5\ 734 - 6\ 321 + 277 = -310 \text{ ppm.}$$

And X equals $150\ 000(1 - 310 \text{ ppm}) = 150\ 000 \times 0.999690 = 149\ 954$ ohms.

9.4. Calibration of Megohm Boxes and 0.1-Megohm Boxes for Use as Resistance Standards

9.4.a. Calibration of the Box

The boxes considered here consist of ten nominally equal resistance coils which may be connected on the panel either in series or in parallel. The components of the 0.1-megohm box are 10 000-ohm coils. With the coils in parallel, the resistance of the box is nominally 1 000 ohms. Its resistance may be compared with that of a 1 000-ohm standard by the usual substitution procedure. Say, the correction found is +250 ppm. With this correction, the resistance of the box is $1\ 000(1 + 250 \text{ ppm})$ ohms.

The same correction applies to the nominal resistance of the box when its components are in series. Hence, the resistance of the box with its components in series is $100\ 000(1 + 250 \text{ ppm})$.

A 1-megohm box may be calibrated the same way. With its 100 000-ohm components in parallel, the resistance of the box may be compared with the resistance of a 10 000-ohm standard. The proportional correction found is also the proportional correction to the 1 000 000-ohm

nominal value of the box when its components are in series.

The method is not limited to megohm and 0.1-megohm boxes, but is applicable to any resistance box having 10 nominally equal stable components which may be used in parallel or in series, permitting a step-up of 100:1. If each component is within 0.1 percent of their average the 100:1 ratio is accurate within one part per million, provided that the insulation resistance is large enough to avoid any appreciable effect on the ratio. The method is very useful for measuring high resistances.

9.4.b. Use of the Calibrated Box as a Resistance Standard

After a box has been calibrated, it may be used in a Wheatstone bridge circuit to measure the resistance of an unknown in the same way that any other standard resistor would be used.

For illustration, consider the use of the 0.1-megohm box as a standard to calibrate a resistor of 150 000 ohms nominal value. After a bridge has been set up with a ratio set adapted to a ratio of 1:1.5 the next step is to find bridge zero.

In figure 30 two 100-ohm standards in parallel have been added to the fixed arm of a DRRS to make the ratio of AC to CF equal to 100:150. Four 1 000-ohm standards in the upper arms of the bridge arranged as shown in the diagram make the ratio of those arms 1 000:1 500. The readings on the bridge corresponding to the different sequences of the standards in the pattern are given in the following table:

$a: \left(b + \frac{c}{d} \right)$	$Rdg_1 = 5\ 435$
$b: \left(c + \frac{d}{a} \right)$	$Rdg_2 = 5\ 412$
$c: \left(d + \frac{a}{b} \right)$	$Rdg_3 = 5\ 400$
$d: \left(a + \frac{b}{c} \right)$	$Rdg_4 = 5\ 433$
	4) <u>21 680</u>
	$Rdg_0 = 5\ 420$

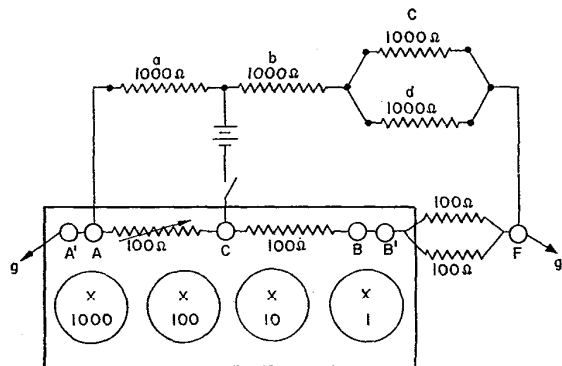

FIGURE 30. Ratio 100:150, to find R_0 .

The standards are removed from the upper arm of the bridge and replaced by the 0.1-megohm box on the left and the unknown on the right. Suppose the reading of the bridge is now 5 580. The correction found for the box was +250 ppm. This is c_L , correction on the left. The correction for the unknown is c_R , correction on the right. Making the relevant substitutions in the equation

$$c_R = Rdg_0 - Rdg + c_L,$$

the correction for the unknown is

$$c_R = 5\ 420 - 5\ 580 + 250 = +90 \text{ ppm.}$$

Hence, the value of the unknown is

$$150\ 000(1 + 90 \text{ ppm}) = 150\ 000 \times 1.000090 = 150\ 014 \text{ ohm}$$

The 1-megohm box may be used in the same way to measure resistances of the order of megohm. Readings to the fourth place on the ratio set may be impossible due to insufficient galvanometer sensitivity. Excessive battery voltage to increase the galvanometer deflection may heat the resistance coils and decrease the accuracy of measurement.

The use of the Direct Reading Ratio Set in the calibration of a Wheatstone bridge is given in detail in sections 11-15.

The examples which have been given illustrate the usefulness and adaptability of the Direct Reading Ratio Set. Theoretically, the set can be adapted to any ratio. However, the number of practicable ratios is limited.

Another ratio set with arms as finely adjustable as those of a slide wire is described in the next section.

10. The Universal Ratio Set

In the preceding sections the Direct Reading Ratio Set and its uses have been discussed. It is usually used for the determination of the difference in resistance between standards and unknown resistors of nominally the same value. When they differ by more than about 0.5 percent the Direct Reading Ratio Set is not usually suitable and a ratio set with a larger range is required. In this case the Universal Ratio Set may be used. It is also very useful where only the ratio of resistances is required, as in the calibration of a potentiometer. This requires the determination of the ratio of the main resistance to the standard cell resistance for the many settings of the instrument.

10.1. The Universal Ratio Set (URS) Compared to Slide Wire

Figure 31 shows the arrangement of dial binding posts on the panel of a recent model six-dial Universal Ratio Set. The first dial is divided into twenty divisions corresponding to a resistance of twenty steps of 100 ohms each.

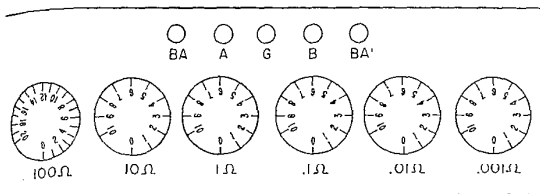

FIGURE 31. Universal Ratio Set.

Each of the other dials is divided into ten steps of resistance values which range from 10 ohms per step on the second dial to 0.001 ohm per step on the sixth dial.

The URS is used to form the ratio arms of a bridge. It is equivalent to a slide wire (fig. 32) with a slider, C (connected to binding post, G), which may move along a wire with a resistance of 2111.110 ohms between the binding posts A and B. Adjustment is made by an arrangement of coils and dial switches such that as one or more dials are advanced, additional resistance is introduced into the AC arm and equivalent resistance is removed from the CB arm of the set. The reading of the dials is the resistance of the AC arm.

The binding post, G, is marked for a galvanometer connection. The binding posts BA and BA' (battery connections) are convenient extra binding posts at the ends of the slide wire. As in Wheatstone bridge circuits, generally, the battery connections are interchangeable with the galvanometer connections. Frequently, the galvanometer is connected to the BA and BA' (or A and B) binding posts and the battery is connected to G.

10.2. Application to Four-Terminal Measurements

The URS is especially suited to the comparison of four-terminal resistors. In figure 33, S and X are a standard resistor and an unknown, in series, connected to the end terminals of a URS. Let X be the value of the unknown and S the nominal value of the standard which has a correction, c_s . The leads, AD and BF , are connecting leads. At the potential terminals of each resistor are short wire tabs, s_1, s_2, x_1, x_2 , for convenient connection of a clip on a battery or galvanometer lead. Also let s_1, s_2, x_1, x_2 be the readings of the URS when the battery clip is connected to corresponding potential points and the circuit is balanced.

With a constant current in the circuit, the difference between two readings on the URS is proportional to the difference of potential between the resistor terminals.

Hence,

$$\frac{x_2 - x_1}{s_2 - s_1} = \frac{\text{The potential drop across } X}{\text{The potential drop across } S}$$

However, the potential difference across any segment of the circuit is proportional to the resistance of the circuit. So,

$$\frac{x_2 - x_1}{s_2 - s_1} = \frac{\text{The resistance of } X}{\text{The resistance of } S}$$

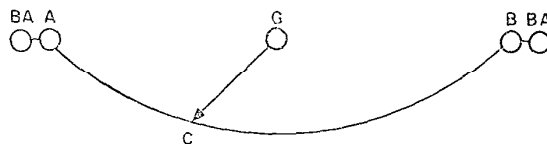

FIGURE 32. Slide-wire representation of URS.

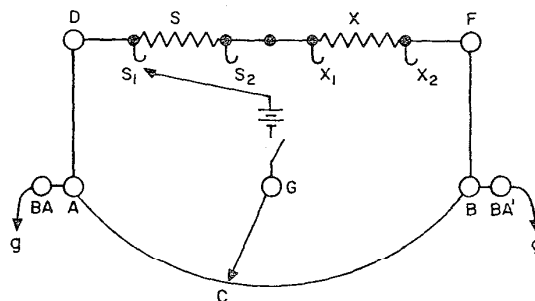

FIGURE 33. Four-terminal measurement with URS.

Since a reading on the URS depends only on the ratio of two resistances, the equation is true even though the current in the URS is not constant.

Using the corrected value of the standard, $S(1+c_s)$, the last equation becomes,

$$\frac{X}{S(1+c_s)} = \frac{x_2 - x_1}{s_2 - s_1}$$

and

$$X = \frac{x_2 - x_1}{s_2 - s_1} \cdot S(1+c_s)$$

Example:

$$\begin{aligned} s_1 &= 0.310 \\ s_2 &= 913.445 \\ x_1 &= 918.132 \\ x_2 &= 1\ 703.027 \\ S &= 10 \text{ ohms} \\ c_s &= -12 \text{ ppm} \end{aligned}$$

$$S(1+c_s) = 10(1 - 0.000012) = 9.99988 \text{ ohms}$$

$$X = \frac{784.895}{913.135} \times 9.99988 = 8.59550 \text{ ohms.}$$

Note that in figure 33 the galvanometer is connected to the URS binding posts, BA and BA'. Then the resistance in the galvanometer circuit does not change as the potential lead is transferred from one point to another, and it is not necessary to change the damping resistance for each reading. This is important when calibrating potentiometers and other instruments having multiple settings. However, it is important that the battery supply be adjustable in order to be able not to overload the coils of the ratio set or the unknown when the balance point is near either end.

An important application of the Universal Ratio Set is its use for measuring voltage ratios in calibrating potentiometers. This application will be explained in Part 3.

Part 2. Calibration of a Wheatstone Bridge

In some of the preceding sections the Direct Reading Ratio Set and its uses have been described. As a further illustration of its use the following detailed outline of the calibration procedure for a Wheatstone bridge is presented.

The bridge for which the calibration procedure and data are given is of the open-dial type intended for the measurement of resistance to a fairly high accuracy. This type of bridge is chosen because practically identical bridges of the same pattern are made by several American manufacturers. They have duplicate sets of ratio coils from 1 to 10 000 ohms and a five-decade rheostat with steps of 0.1 to 1 000 ohms inclusive. Push-button switches are provided, one in the battery branch and one in the galvanometer branch of the bridge circuit. The procedure for the calibration of this bridge is essentially the same as for other commercial Wheatstone bridges and the directions to be given may be readily adapted to almost any such bridge.

11. Test Equipment

Standard resistors: Two 10-ohm standards and one each of 1-ohm, 100-ohms, 1 000-ohms, and 10 000-ohms, nominal value.

Mercury stand

Shorting link

Direct Reading Ratio Set

Auxiliary rheostat: The rheostat arm of another bridge or any resistance box with resistance decades corresponding to the decades of the bridge being tested.

Sensitive galvanometer

Galvanometer damping resistance

Battery key, preferably a reversing key

Battery rheostat, a variable resistor to regulate the voltage applied to the test circuit.

Battery (10-12 v)

D-c voltmeter (0-10 v)

Thermometer, to determine room temperature and the temperature of resistance standards during the test.

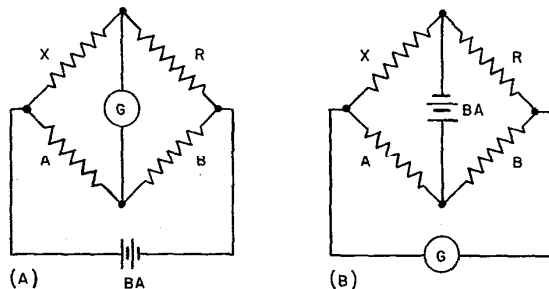

FIGURE 34A AND B. Conventional diagrams of Wheatstone bridge circuit.

12. The Wheatstone Bridge Circuit

The Wheatstone bridge is represented schematically by the well-known diamond-shape diagrams of figures 34A and B. The letters X , R , A , and B are used to represent the arms of the bridge and also their respective resistance. Resistors A and B form the ratio arms. One or both of these arms are variable. X is a resistor of unknown value. R is a resistor of known value which may be fixed, or R may be a calibrated rheostat. G is a sensitive galvanometer and BA is a battery of suitable voltage. Whether the battery and the galvanometer are connected as in figure 34A, or as in figure 34B, the value of the unknown resistor is given by the basic equation

$$X = \frac{A}{B} R,$$

when no current through the galvanometer shows that the bridge is balanced.

Figure 35 is a generalized diagram of a laboratory bridge, showing binding posts and switches or key. Since the circuit may be either the circuit of figure 34A or that of figure 34B, the binding posts in this diagram are indicated by number. Binding posts (2) and (4) may be battery binding posts BA , or they may be galvanometer binding posts G . The key may be between (2) and a , or between (4) and c . Likewise, (3) and (5) may be either galvanometer or battery binding posts and the key may be between (3) and b , instead of the position shown in the diagram. The binding posts (1) and (6) are for connection of the unknown resistor which forms the X arm of the bridge. The small letters a , b , c , and d indicate branch points where bridge arms and leads from the binding posts join.

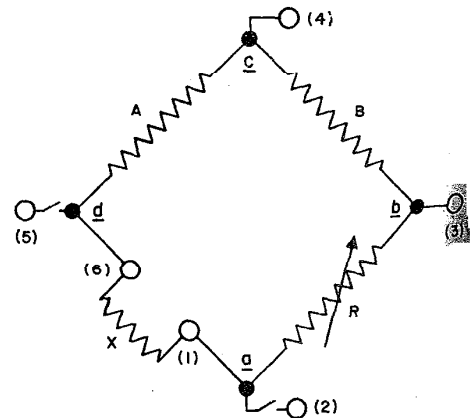

FIGURE 35. Generalized diagram of laboratory bridge.

12.1. Ratio Arms, A and B

A set of resistance coils of 1, 10, 100, 1 000, and 10 000 ohms, nominal resistance, is arranged so that any one of them may be connected into the circuit by a plug or a switch to form the *A* arm. A corresponding set of resistors (or the same set) may be connected into the circuit, one at a time, to form the *B* arm. The ratio, *A/B* may be varied from 1/10 000 to 10 000/1. The range of obtainable ratios is not the same on all models.

12.2. Rheostat Arm, R

The rheostat arm of a five-dial bridge is illustrated schematically in figure 36. The first decade, 1 000 ohms per step, contains nine or ten 1 000-ohm resistance coils in series. Any number of these resistance coils, from zero to nine or ten, can be connected in series in the circuit by a dial switch to give a range of resistances from zero to 9 000 or 10 000 ohms. The other decades are similar, providing resistances of 100, 10, 1, and 0.1 ohm per step, respectively. The last decade usually has ten steps, affording a range in 0.1-ohm steps from zero to 1.0 ohm. With the dials set at 9, 9, 9, 9, and 10, respectively, the resistance of the arm is 10 000 ohms, nominal value. This setting of the dials may be conveniently written 9 999.X, in which *X* represents the reading of 10 on the right hand dial.

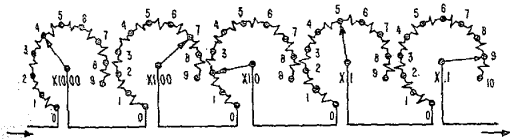

FIGURE 36. Schematic diagram of rheostat arm of bridge.

13. Outline of Test Procedures

13.1. Need for Testing

Due to manufacturing tolerances and to changes in resistance with age, temperature, and humidity, the true value of a resistor is very rarely the same as its nominal value. Hence, the resistance elements of a bridge should be recalibrated from time to time. In addition to the true values of the resistors which compose the ratio arms and the rheostat arm, it is also necessary to know the resistances of the switch contacts and the internal leads.

It is assumed that the bridge which is to be tested is in satisfactory working condition. If it is found defective, it should be sent to the factory for repairs, or referred to someone who is experienced in instrument repair. The beginner in testing should not open the bridge.

13.2. Required Measurements

The measurements that are to be made in testing a Wheatstone bridge are:

1. "Zero" resistance of the rheostat arm and the resistance of the leads from the *X* binding posts to the adjoining arms of the bridge.
2. The resistance of each coil in the rheostat arm.
3. The resistance of each coil in each ratio arm. The resistance measurements are made with a Direct Reading Ratio Set used with a sensitive galvanometer. It is not necessary to make the tests in the order given above.

Test 1. This test consists of two parts. The *zero resistance* is the resistance at switch contacts in the rheostat arm, measured with all dials on zero, plus the resistance of leads within the arm. The resistance is measured between the branch points *a* and *b*, figure 35. It is usually reported as the resistance for the zero setting of the highest decade, and if significant, is included in the correction to each step of the decade.

The *internal lead resistance* is the resistance of the leads from the *X* binding posts, (1) and (6) figure 35, to the branch points *a* and *d*, respectively.

Test 2. The resistance for each dial setting of the rheostat arm is measured with current leads to binding posts corresponding to the conditions of use.

Test 3. Each coil of each ratio arm is measured by the interchange method. The resistors of the *A* arm are measured between the branch points *c* and *d*. The resistors of the *B* arm are measured between *b* and *c*. Even though the same resistance coil may be used in either arm, it should be measured in both, because the lead resistance from the coil to one arm may differ from the lead resistance to the other.

If *A'*, *B'*, and *R'* are corrected values of the bridge arms, and *r* is the internal lead resistance of the bridge, the value of the unknown is given by the equation;

$$X = \frac{A'}{B'} R' - r.$$

A complete equation, including the nominal values of the resistors and their respective corrections, is

$$X = \frac{A}{B} (1 + a - b) (R_1 + c_1 + R_2 + c_2 + R_3 + c_3 + R_4 + c_4 + R_5 + c_5) - r.$$

In the above equation, *A* and *B* are the nominal values of the ratio arms; *a* and *b* are their respective corrections; *R*₁, *R*₂, *R*₃, *R*₄, and *R*₅ are the nominal values corresponding to the dial readings; *c*₁, *c*₂, *c*₃, *c*₄, and *c*₅ are their respective corrections; and *r* is the internal lead resistance in the same arm as the unknown resistance.

13.3. The Circuit Diagram

Before the test procedures listed above can be applied to a bridge, it is necessary to have a correct diagram of the bridge circuit. For example, it may be seen from figure 35 that the zero resistance of the rheostat arm may be measured by taking current leads to binding posts (1) and (6) and potential leads to binding posts (2) and (3) with the key between (2) and *a* closed. Before the test can be made it is necessary to know the panel designations of the numbered binding posts. The working diagram will be figure 35 with the binding post numbers replaced by the panel designations. However, battery and galvanometer keys may be in a position different from that shown in figure 35.

The usual panel markings on an American bridge are:

- BA Battery
- GA Galvanometer
- X Unknown Resistor

In a circuit diagram, the relative positions of the binding posts on the panel are shown by subscripts, *L* and *R* for left and right, or *L* and *U* for lower and upper.

The manufacturer's diagram of the circuit is usually satisfactory. If a circuit diagram is not available, it is necessary to produce one by tracing the circuit. It is desirable to check any diagram on hand because an occasional bridge may differ in some detail from the maker's diagram.

The circuit of the bridge can be traced with a simple tester, or volt-ohm-meter (VOM), by measuring approximate resistances between pairs of binding posts with keys open and with keys closed. The rheostat arm and the ratio arms can be identified readily by varying the resistances in the respective arms.

Test 1 can be carried out usually without reference to a diagram. With the current leads connected to the *X* binding posts, DRRS readings can be taken with the potential lead to each binding post on the panel. Then, the arrangement of the circuit can be determined by comparing the DRRS readings. The method will be explained in a later section.

13.4. Reducing Contact Resistance

Plugs and the contact surfaces of open dial bridges should be cleaned and lubricated. Clean with a harsh cloth or specially prepared paper wipers, not an abrasive. Lubricate with pure vaseline or a highly purified, light petroleum oil. A beginner should not open a bridge to clean and lubricate concealed contacts.

Mercury contacts on standard resistors should be clean and amalgamated. Any crusted amalgam on the surfaces should be carefully scraped and the clean surfaces re-amalgamated (sec. 5.2).

Current leads from test equipment should not be taken through the key contacts of the bridge.

When apparatus is set up for testing, binding-

post connections should be well tightened. Plug should be inserted with a firm, slightly rotary motion.

13.5. Load Tolerance

If excessive current flows in any part of the circuit, heat is generated in that part faster than it can be dissipated, the temperature rises, and the resistance changes. Measurements become inaccurate.

If the galvanometer is satisfactorily damped it will generally indicate an overload. When the battery key is closed, the galvanometer spot will move normally across the scale, come nearly to rest, then slowly continue its motion as heat accumulates in the circuit. With a galvanometer of high sensitivity, overloading can be avoided if deflections are kept reasonably small.

A load of 0.1 w is usually safe. With a good galvanometer, it is generally more than enough for adequate deflections. In some cases, a somewhat larger load may be tolerable if quick readings are taken and the battery key immediately opened.

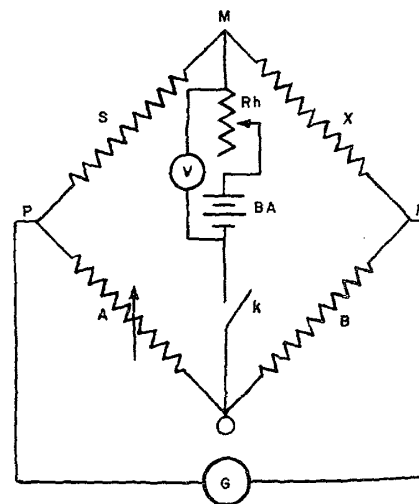

FIGURE 37. Recommended test circuit.

In the circuit of figure 37, A and B represent the arms of a DRRS, S is a resistance standard and X is an unknown resistor of the same nominal value as S. The current from the battery divides at M into approximately equal parts in the left and right branches, MPO and MNO, of the circuit. The emf applied to each of these branches can be adjusted by the battery rheostat, Rh, and can be read on the voltmeter, V.

For a given load, P (watts), in either branch the emf is $V = \sqrt{PR}$ when R is the resistance of the branch in ohms. Hence, the voltage for a load of 0.1 w is $V = \sqrt{0.1R}$. The voltage indicated by this formula is usually more than sufficient.

13.6. Applicability of General Principles

The preceding pages have given pre-test preparations and precautions required for accuracy, with a statement of the steps to be taken in the test of a Wheatstone bridge. Since Wheatstone bridges consist of the same basic parts, namely, two ratio arms, a rheostat arm, and the internal leads from the binding posts for the unknown resistor, the testing problem depends only on understanding the use of test equipment to make the necessary measurements on each part.

The following section will explain the test of a specific model in detail. With a knowledge of the general principles and their application, it should be possible to make the minor modifications of procedure required for testing any of the makes and models in common use.

14. Test of Open Dial Bridge

The order in which the different parts of the bridge circuit are tested, generally, is immaterial. The tests will be presented in the following order:

- Test 1: Zero and internal lead resistance.
- Test 2: Rheostat arm.
- Test 3: Ratio arms.

14.1. Test 1: Zero and Internal Lead Resistance

This test may serve, in the absence of a circuit diagram, to trace the bridge circuit and, at the same time, to obtain the desired resistance measurements.

The connections for the test are shown schematically in figure 38. The measurements are made with a Direct Reading Ratio Set by the method for the measurement of a small resistance (sec. 8.5). The 10-ohm resistors are standards on a mercury stand. Since it is assumed that the connections of the binding posts to the bridge network are unknown, the notation of figure 35 is used in this figure.

The dashed line between *b* and *d* indicates that the ratio arms have been short-circuited by inserting plugs on each side of the same stud between the *A* and *B* bars. The "hooks" at the binding posts represent bare, copper wire tabs for convenient "potential point" connections for a clip on the end of the battery lead.

Leads from the DRRS go through the 10-ohm standards to the *X* binding posts, (1) and (6), and the circuit is completed through the internal leads, the rheostat arm, *R*, and the short across the ratio arms. Each dial of the rheostat arm is zero. The "potential" leads pass through the binding posts to the effective potential points, *a*, *b*, *c*, *d*, and (6). The *BA* and *GA* keys are closed to permit connection to the potential points *a* and *d*. The assumption that the keys are located as shown may not be correct. The test will show their true position.

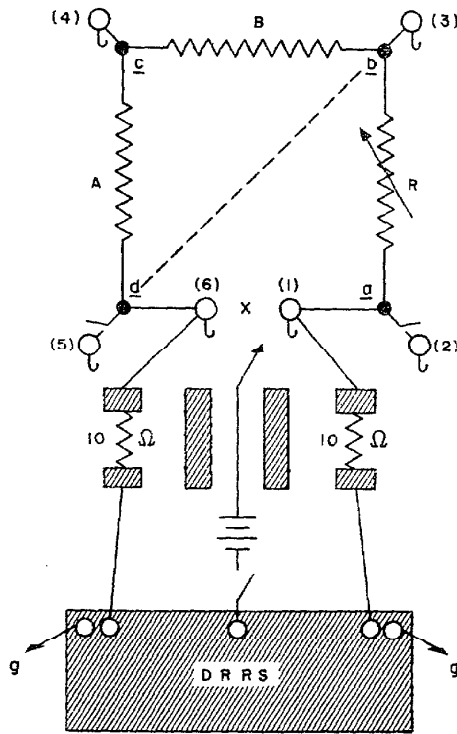

FIGURE 38. Connections for zero and lead resistance (schematic).

A reading on the DRRS is taken at each potential point. From figure 38, it is evident that a reading at (4) is superfluous. However, if it is not known which binding post on the bridge panel is connected to the junction of the ratio arms, it is necessary to take a reading at each. The tabulated data will show:

1. The identity of each binding post on the bridge panel with the corresponding numbered binding post of figure 38;
2. The zero resistance (resistance between branch points *a* and *b* with all dials on zero);
3. The internal lead resistance (resistance from (1) to *a* plus the resistance from (6) to *d*).

The connections of the bridge to the test circuit are shown in figure 39. A sample set of test data is given in table A. If the bridge circuit is known before the test, the tabulation is simplified. In that case, the reader may turn to the paragraph below, marked **.

Column I of table A shows each reading taken on the DRRS as the battery clip was connected to each binding post. First, the keys were open. No reading could be taken at *BA*, until the *BA* key was closed which showed the location of the battery key in the circuit. It is indicated in the table by the letter "k." The location of the galvanometer key was determined in the same way.

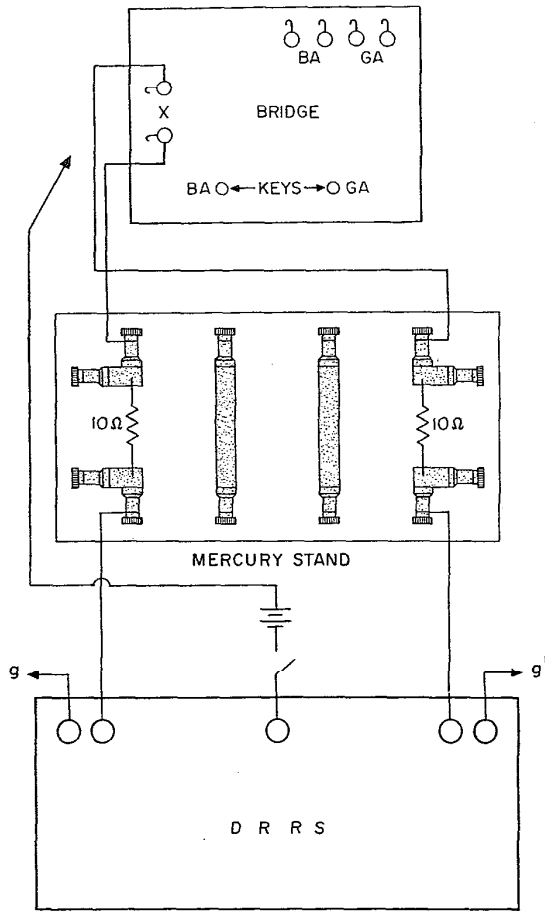

FIGURE 39. Connections to open-dial bridge for zero and lead resistance.

TABLE A

I	II	III	IV
X_L 6 648	X_U 4 673	0.00046	1
X_U 4 673	kBA_L 4 764		2
kBA_L 4 764	GA_R 6 200	.00718	3
BA_R 6 308	BA_R 6 308	.00099	4
kGA_L 6 555	kGA_L 6 555	.00078	5
GA_R 6 200	X_L 6 648	.00046	6

The data of column I were rearranged in column II in the order of magnitude of the DRRS readings. Column II shows the order in which the binding posts of the bridge are connected into the circuit. Column III gives the resistances between consecutive potential points (or branch points). For

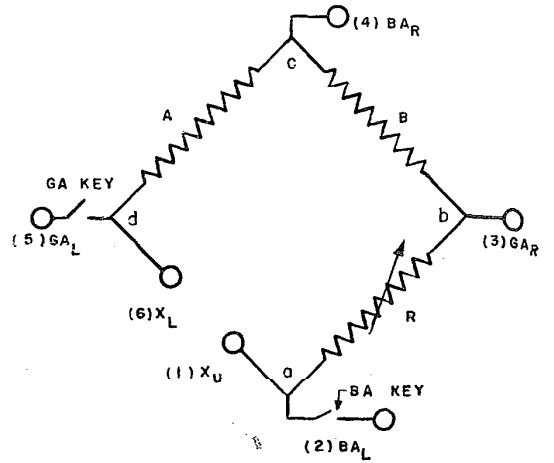

FIGURE 40. Identification of bridge binding posts with the post numbers of figure 35.

example, the resistance between the upper \downarrow binding post, X_U , and the branch point to which the left battery binding post, BA_L , is connected is

$$\frac{4\ 764 - 4\ 673}{2} = 46.$$

Since 10-ohm resistance standards were used, this is 46 parts per million of 10 ohms, equal to 0.00046 ohm. This is the resistance of one of the internal leads. The other internal lead is from X_L to the branch point where the lead from GA joins the network. This lead also has a resistance of 0.00046 ohm, making the total internal lead resistance 0.00092 ohm. (The two internal lead are not always equal.)

The largest resistance in column III is 0.00718 ohm. This is the zero resistance of the rheostat arm. Hence, GA_R and BA_L are connected to the ends of that arm. The other resistance values in column III are not used.

Column IV of the table lists the binding-post numbers of figure 35 which correspond to the bridge designations in column II. Figure 40 is a repetition of figure 35 into which the designation of the binding posts on the bridge panel have been entered. The relative distribution may be different in another make of bridge and the location of the BA and GA keys may be different. In this case, the circuit diagram is the diagram of figure 35 with the numbers replaced by the corresponding panel designations of the binding posts, and the location of the keys corrected, if necessary.

The completion of the circuit, figure 40, is based on the data of table A. From columns II and III, it is seen that the lead from X_U (0.00046 ohm) joins the lead from BA_L at a branch point which is at one end of the rheostat arm (0.00092 ohm). The other end of the rheostat arm is joined by the lead from GA_R . Hence the binding posts (1) and (2) of figure 35 are replaced by X_U , BA_L , and (3) of figure 35 are replaced by X_U , BA_L , and GA_R , respectively.

At the bottom of the table, it is seen that the lead from X_L (0.00046 ohm) joins the lead from GAL at a branch point of the network. Hence, (6) and (5) are replaced by X_L and GAL , respectively. That leaves BA_L to replace (4) and complete the working diagram of the bridge circuit.

**If the circuit diagram is available at the beginning of the test, the DRRS reading at BA_L will be omitted. The data may be tabulated as follows:

TABLE B

Pot. pt.	Rdg.	Computation	Resistance
GAL	6 200	$\frac{6\ 200 - 4\ 764}{2} = 718$	"Zero" = 0.007 ohm.
BA_L	4 764	$\frac{4\ 764 - 4\ 673}{2} = 46$	
X_r	4 673	$\frac{6\ 648 - 6\ 555}{2} = 46$	Lead = 0.0009 ohm.
X_L	6 648		
GAL	6 555		

Although the computations give values to five decimal places, they are rounded off to the values shown above. Measurements are rounded off to conform to the degree of accuracy stated in the NBS certificate, a sample copy of which is included in this paper. A study of this copy will show the practice generally followed at the National Bureau of Standards.

The zero resistance is reported as the resistance at the zero setting of the top dial of the bridge.

The lead resistance is the quantity r in the equation

$$X = \frac{A'}{B'} R' - r,$$

in which A' , B' , and R' are the corrected values of the respective bridge readings, A , B , and R . The complete equation has been given in section 13.2.

14.2. Test 2: The Rheostat Arm

The method described here is applicable to any decade type of rheostat or resistance box. In figure 41, let X be a resistance decade of the rheostat arm of a bridge. Let Y be an auxiliary rheostat, as the rheostat arm of another bridge, or a resistance box with decades corresponding to the decades of X . Evidently X and Y are interchangeable in the circuit. Hence, both may be calibrated simultaneously.

The mercury contact surfaces, h and k , of a mercury stand, permit the convenient exchange of a shorting link for a resistance standard, or vice versa. D is a resistance standard with a nominal value ten times the value of the standard on the left. Its corrected value is not needed. A and B are the arms of a Direct Reading Ratio

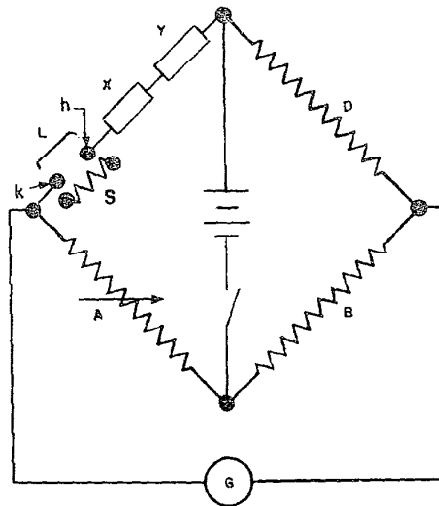

FIGURE 41. Schematic diagram of circuit for test of rheostat arm.

If the 100-ohms-per-step decade of X is to be calibrated, a 100-ohm standard is used on the left. Each resistance coil of the decade is compared with this 100-ohm standard. A 1 000-ohm standard is used at D . To test the first step of the decade, set the dial at zero, set Y at 900 ohms (step 9 on the 100 ohms-per-step decade), and place the 100-ohm standard on the mercury stand. The nominal resistance of the left upper arm is 1 000 ohms, corresponding to the 1 000 ohms in the right upper arm. Balance the circuit and take a reading (Rdg_1) on the DRRS. Then advance the dial on X to step 1. Replace the 100-ohm standard with the link. This change substitutes the first coil of the decade for the standard. Balance the circuit and take Rdg_2 on the DRRS. Let c_s be the correction for the standard and c_L the correction for the link. Then the correction to the nominal value of the first step of the 100 ohms-per-step decade of X , in parts per million is,

$$c_x = 10(Rdg_2 - Rdg_1) + c_s - c_L.$$

This equation gives the correction in parts per million of the nominal value of the resistance coil which is being tested. The term, c_L , is included in the equation for completeness. However, it is negligible when the nominal value of the coil exceeds ten ohms, provided that the resistance of the link does not exceed 50 microhms. The factor, 10, in the equation is necessary because the resistance of each of the upper arms of the test circuit is 1 000 ohms. Therefore, $Rdg_2 - Rdg_1$ is parts per million of 1 000 ohms. The difference in the readings must be multiplied by ten to change it to parts per million of 100 ohms before the correction for the standard, c_s , is added.

For example, suppose the correction for the standard is +45 ppm.

Rdg₁, with standard in the circuit, X on zero, Y on step 9 5489
 Rdg₂, with the link in the circuit, X on step 1, Y on step 9 5478

Rdg ₂	5 478
Rdg ₁	5 489

Rdg ₂ -Rdg ₁	-11
× 10 =	-110
+c _s	+45 (c _L , negligible)

=c _x	-65 ppm

$100 \times (-0.000065) = -0.0065$ ohm, correction for the first step.

The 1 000-ohm resistor in the right upper arm of the test circuit, often referred to as the dummy, serves only to balance the circuit and does not enter into the computations. Any reference to the "standard" is a reference to the standard resistor in the left upper arm, with which the coils of the decade are compared.

To find the correction for the second step of the decade, leave the dial on step 1, replace the link with the 100-ohm standard, set Y back to step 8 (800 ohms), and take Rdg₃ on the DRRS. Replace the standard with the link, advance the dial on X to step 2, and take Rdg₄. Since c_x is negligible for this decade, the correction for the second coil is $10(Rdg_4 - Rdg_3) + c_s$. If Rdg₃ is 5 473 and Rdg₄ is 5 464, the correction is -45 ppm, or, $100 \times (-0.000045) = -0.0045$ ohm.

Each step of the decade is tested in the same way. At each step on X, the corresponding decade on Y is set back one step to maintain a balanced circuit.

The step-by-step measurements give the corrections for each individual coil of a decade. When the bridge is used to measure an unknown resistance, several coils may be in series. If the dial of any decade is set on 5, the first five coils of that decade are in series. The correction to the nominal value at that setting is the sum of the corrections to the five coils in use. Hence, a step-by-step summation must be made of the corrections to the coils in the decade to find the correction applicable to each dial setting.

14.2.a. Calibration of X and Y

As has been pointed out, the decades of the two rheostats, X and Y, may be calibrated simultaneously. Compare Rdg₂, above, with the 100-ohms-per-step decade of Y at step 9 and Rdg₃ with Y at step 8. From these readings the correction for the 9th coil on Y is $10(Rdg_2 - Rdg_3) + c_s$, that is, $10(5\ 478 - 5\ 473) + 45 = +95$; $100 \times 0.000095 = 0.0095$ ohm.

The corrections for each coil of the Y decade will be in order downward from the 9th coil to the 1st. Hence, the summation of the corrections begins with the first coil at the bottom of the column and proceeds upward until the sum of the

corrections for all the coils in the decade is shown at the top.

If there are ten coils in a decade, the procedure differs only in that there is one more coil to be measured.

Other decades (except the 0.1-ohm-per-decade) are measured in the same way. For 1 000 ohms-per-step decade, the standard will be 100 ohms and the dummy, D, will be 10 ohms. Likewise, for the 10-ohms-per-step decade the standard will be 10 ohms, D will be 100 ohms and for the 1-ohm-per-step decade, the standard will be 1 ohm, D will be 10 ohms. Note the correction for the 1-ohm standard must be its two-terminal value.

If the standard and the link are substituted, one for the other, in the circuit as explained above it will be necessary to include the correction to the link in the equation for c_x when testing 10-ohms-per-step and the 1-ohm-per-step decades. For measurement of the resistance of the link, "Measurement of a Small Resistance" (sec. 4.3.1). A copper link ¼ in. in diameter and 3 in. between centers of contact surfaces will have a resistance of approximately 40 microhms. With that resistance, the correction for the link will be 40 ppm when used with a 1-ohm standard, or 4 ppm when used with a 10-ohm standard.

The correction for the link may be avoided by the arrangement shown in figure 42. With the standard and the link on one end of a mercury stand, as shown in the diagram, the link serves as a switch in the lead from the DRRS. When the link is in the position shown by the solid curve, the standard is in the measuring circuit. When the link is in the position shown by the dashed curve the standard is cut out of the circuit. Since the resistance of the link is a fixed part of the lead resistance, it does not enter into the computation. When the standard is in the circuit, the resistance of the bar between the link and the standard is included. This resistance is negligible for ½-in.-square nickel plated copper bars of the N stand.

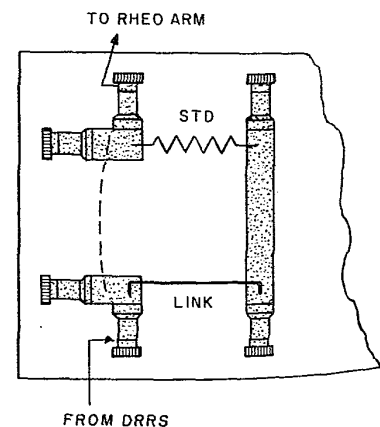

FIGURE 42. Use of link as a switch.

TABLE C. Data from test of 10-ohms-per-step decades of bridges X and Y.
 Temperature, 25.0 ° C. Correction for 10-ohm standard, +6 ppm.

				Bridge X			Bridge Y		
I	II	III	IV	V	VI	VII	VIII	IX	X
X	Y		DRRS	c, ppm	Summation	c, ohm	c, ppm	Summation	c, ohm
0	9	S	5 500	-194	-194	-0.002			
1	9		5 480				-204	-2 546	-0.025
1	8	S	5 501	-234	-428	-.004			
2	8		5 477				-344	-2 342	-.023
2	7	S	5 512	-364	-792	-.008			
3	7		5 475				-284	-1 998	-.020
3	6	S	5 504	+56	-736	-.007			
4	6		5 509				-324	-1 714	-.017
4	5	S	5 542	-544	-1 280	-.013			
5	5		5 487				-334	-1 390	-.014
5	4	S	5 521	-544	-1 824	-.018			
6	4		5 466				-274	-1 056	-.011
6	3	S	5 494	+446	-1 378	-.014			
7	3		5 538				-224	-782	-.008
7	2	S	5 561	-524	-1 902	-.019			
8	2		5 508				-284	-558	-.006
8	1	S	5 537	-594	-2 496	-.025			
9	1		5 477				-274	-274	-.003
9	0	S	5 505						

Some difficulty may be encountered in getting galvanometer readings on scale when testing the 1-ohm-per-step decade. This difficulty results from badly unbalanced resistance of the leads from the stand to the rheostats. It is easily overcome by modifying the lead resistance.

Figure 43 shows the arrangement of apparatus for the simultaneous test of the rheostat arms of two bridges. Reference to figure 40 shows that current leads should be taken to binding posts X_U and GA_R . A current lead should not be connected to BA_L because the BA key contact may not maintain constant resistance. The battery or potential lead goes to the junction between the dummy, D , and bridge Y .

Table C gives the data obtained from a test of the 10-ohms-per-step decades of the two bridges. D was a 10-ohm resistance standard. D was 100 ohms. Since the link, L , was used as a switch as

shown in the diagram, no link correction entered into the computations.

Column I in the table gives the settings of the dial of bridge X ; column II, the settings of the dial of bridge Y . Column III shows the standard in the circuit at certain dial settings. The DRRS readings for each pair of dial settings are given in column IV. Columns V, VI, and VII include data for bridge X . In column V are the corrections in parts per million for each resistance coil of the decade. Column VI is the step-by-step summation of the corrections in Column V. The corrections of column VI, which are in parts per million, are rounded off and expressed as fractions of an ohm in column VII. The latter are the corrections to be used for each dial setting of the decade. Columns VIII, IX, and X give the corresponding data for bridge Y , reading upward from the bottom of the table.

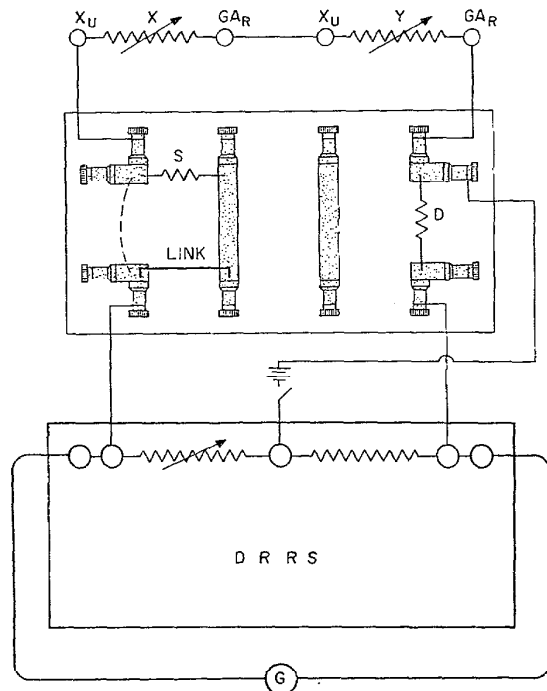

FIGURE 43. Connection of two rheostat arms into test circuit.

14.2.b. The 0.1-Ohm-Per-Step Decade

The steps of this decade are compared directly with the steps on the $\times 1\,000$ dial (or 0.1-ohm-per-step decade) of the Direct Reading Ratio Set. In figure 44, *A* and *B* are the arms of the DRRS. The dummy resistor, *D*, is 100 ohms. As in preceding tests, the rheostat arm of the bridge and the auxiliary rheostat are in series in the left upper arm of the test circuit. Set the auxiliary on 99.5 ohms. Set the dials of the bridge on zero. Balance the circuit with the dials of the DRRS. It may be necessary to change the setting of the auxiliary slightly, so that, when the circuit is balanced, the $\times 1\,000$ dial of the DRRS will read zero, corresponding to the zero reading of the dial to be tested.

Advance the 0.1-ohm-per-step dial of the bridge, step by step, taking a reading on the DRRS at each setting of the bridge dial. Subtract the reading at step zero from each subsequent reading. The results will be the true values for the corresponding settings of the bridge dial. Subtracting the indicated value from the true value of each step will give the correction.

If the bridge has a 0.01-ohm-per-step decade, it is tested in the same way by comparing it with the steps of the corresponding decade of the DRRS.

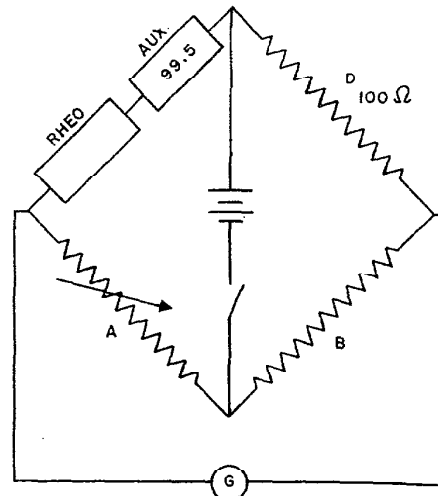

FIGURE 44. Test of 0.1-ohm-per-step dial.

TABLE D. Sample data from a test of a 0.1-ohm-per-step decade

Step	DRRS	Resistance	Correction
0	0 456	0.0000	0.0000
1	1 458	.1002	+.0002
2	2 457	.2001	+.0001
3	3 450	.3000	.0000
4	4 456	.4000	.0000
5	5 456	.5000	.0000
6	6 456	.6000	.0000
7	7 456	.7000	.0000
8	8 455	.7999	-.0001
9	9 454	.8998	-.0002
10	10 455	.9999	-.0001

The corrections for this dial (all less than 0.001 ohm) were negligible.

14.3. Test 3: The Ratio Arms

The connections on the panel for selection of ratio arms consist of two heavy bus bars marked *A* with a third bus bar, *B*, between them. Between each *A* bar and the *B* bar is a row of studs, each of which may be connected to either bar by a plug. Each stud is connected to a resistor of the denomination marked on the stud to a bus wire which extends internally underneath the *B* bar and terminates at the binding post BA_R . The connections of the bus wires to the *A* bars, and the *B* bar to the binding post, are shown in the diagram, figure 45.

With a plug inserted between any stud and the *A* bar, the *A* bar is connected through the indicated resistor to BA_R . Likewise with a plug inserted between any stud and the *B* bar,

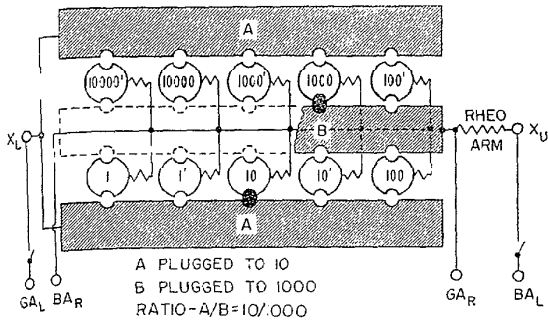

FIGURE 45. Block and plug arrangement for ratio arms.

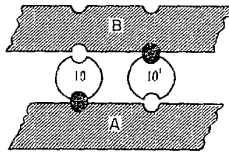

FIGURE 46. Plugs set for ratio 1:1.

bar is connected through the resistor to BA_R . With studs inserted on both sides of the same stud, the ratio arms are short-circuited. A one-to-one ratio may be obtained by plugging the A bar and the B bar to two different studs of the same denomination. In figure 46, the A bar is shown plugged to stud 10, the B bar to stud 10' for a ratio of one to one. Figure 45 shows that any one of the ten resistors may be plugged to either arm.

Plugs should be well fitted, clean, lubricated, and inserted with a firm, slightly rotary motion. The measured correction for any resistor when measured in one arm should agree reasonably with the measurement in the other arm. However, contact and lead resistances between the resistor and the terminals of one arm differ from the resistances between the resistor and the terminals of the other. These differences are small relative to a 10 000-ohm resistor, large with respect to a 1-ohm resistor. The measurements on a 10 000-ohm resistor in each arm will usually agree within 2 ppm. Corresponding measurements on a 1-ohm resistor may disagree by more than 100 ppm. The effect of contact and lead resistance is such that the use of a 1-ohm resistor in either arm is to be avoided, if possible, when precision is important.

14.3.a. The A Arm

Reference to the circuit diagram, figure 47, shows that to measure the resistors of the A arm, current leads may be taken to X_L and BA_R , potential leads to GA_L (GA key locked down) and GA_R . The resistances are measured between the branch points d and e by the interchange method.

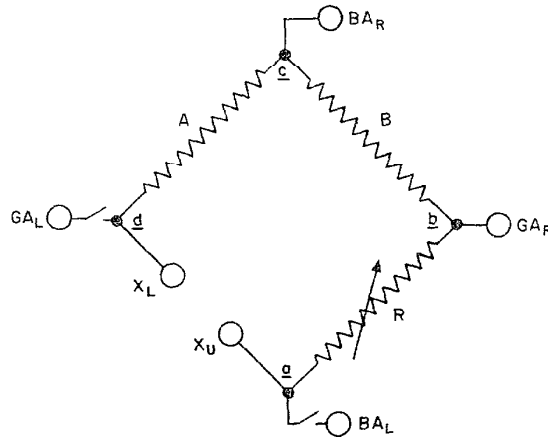

FIGURE 47. Schematic bridge circuit.

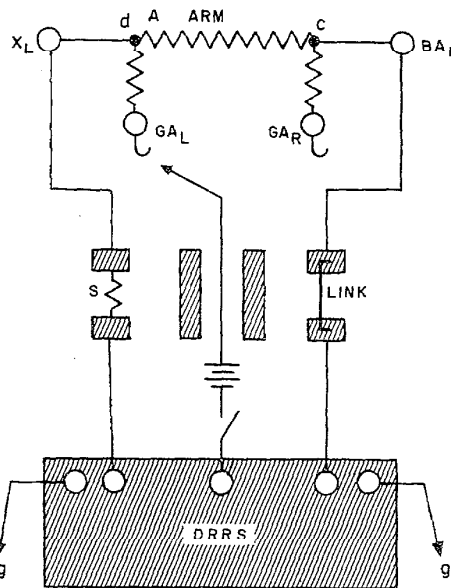

FIGURE 48. Test connections for A arm.

The arrangement of the test circuit is shown in figure 48. To measure resistor 1 (1 ohm), plug stud 1 to the A bar, stud 1' to the B bar. Place a 1-ohm resistance standard on the left of the stand and a link on the right. With the battery lead to GA_L , take Rd_1 on the DRRS. Exchange places between the standard and the link, connect the battery lead to GA_R , and take Rd_2 .

To measure 1', plug stud 1 to the B bar, plug 1' to the A bar. Repeat the above procedure.

With stud 1 still plugged to the B bar, plug each remaining stud in turn to the A bar and take the readings, using appropriate standards.

For each resistor in the arm substitute the corresponding readings in the following equation:

$$c_x = \frac{Rdg_2 - Rdg_1}{2} + c_s - L \quad (\text{sec. 8.3}).$$

The correction for a 1-ohm standard must be its two-terminal value (sec. 8.6). The correction, L , for the link was discussed in connection with the test of the rheostat arm. If the link is used with a 1-ohm standard the correction will be equal to its resistance in microhms. If used with a 10-ohm standard, the correction will be one-tenth of that value. With resistance standards in excess of 10 ohms, the correction is usually negligible.

The results in the fifth column of table E are corrections in parts per million. The corrections in the last column are in proportional parts, rounded off as they appear in the certificate.

14.3.b. The B Arm

Reference to the circuit diagram shows that measurements on the B arm can be made by taking current leads to BA_R and GA_R and the potential lead alternately to X_L and X_U as shown schematically in figure 49. The A bar should be plugged to a one-ohm stud, but not one being

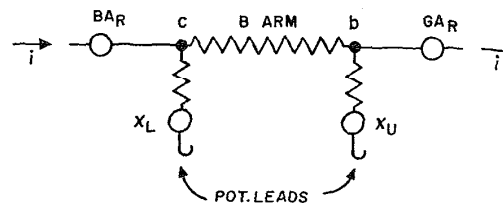

FIGURE 49. Test connections for B arm.

tested on the B arm. The potential lead through X_U goes through the rheostat arm to the branch point b . Therefore, all dials should be on zero. The resistances measured are between the branch points c and b .

Plug the B bar to each stud in turn and measure the corresponding resistance coil. Differences in the measurements in the A arm and in the arm have been explained above. These differences usually become progressively smaller as the measurements proceed from a one-ohm coil to 10 000-ohm coil.

After the first tests on a bridge are complete a second worker repeats the tests, using different equipment, if possible, especially different resistance standards. A comparison of the results will

TABLE E. Test of A arm.

Sample data from laboratory notes.

Bridge S/N _____. Current leads to X_L and BA_R . Potential leads to GA_L and GA_R . Resistance of link, 40 microhms. Date.

Plug	Std., temp., and corr.	DRRS Readings		Computations	Correction
		Std. at left	Std. at right		
1	#31/24.8 +77	7 437	7 058	$\frac{7\ 058 - 7\ 437}{2} + 77 - 40 = -153$	-0.0002
1'	Same.	7 453	7 057	$\frac{7\ 057 - 7\ 453}{2} + 77 - 40 = -161$	-.0002
10	#24/24.8 +6	5 573	5 544	$\frac{5\ 544 - 5\ 573}{2} + 6 - 4 = -12$	-.00001
10'	Same.	5 567	5 546	$\frac{5\ 546 - 5\ 567}{2} + 6 - 4 = -8$	-.00001
100	#26/24.8 +45	5 343	5 423	$\frac{5\ 423 - 5\ 343}{2} + 45 = +85$	+ .00008
100'	Same.	5 332	5 432	$\frac{5\ 432 - 5\ 332}{2} + 45 = +95$	+ .00010
1 000	#400/24.9 -19	5 261	5 467	$\frac{5\ 467 - 5\ 261}{2} - 19 = +84$	+ .00008
1 000'	Same.	5 247	5 480	$\frac{5\ 480 - 5\ 247}{2} - 19 = +97$	+ .00010
10 000	#5/24.9 +624	5 969	4 754	$\frac{4\ 754 - 5\ 969}{2} + 624 = +16$	+ .00002
10 000'	Same.	5 957	4 766	$\frac{4\ 766 - 5\ 957}{2} + 624 = +28$	+ .00003

reveal any mistakes or errors. The results of two tests on a resistance coil should differ by much less than 0.01 percent of the nominal value of the coil. The certified values are the average values determined by the two tests.

14.3.c. Working Test

After a bridge has been tested, some of the results may be spot checked by using standard

resistors as unknowns and comparing the values measured on the bridge with the corrected values of the standards. Different resistance values may be measured at different settings of the ratio arms. Substitution of the readings on the bridge and their respective corrections in the equation for X should give for each resistance standard measured, a value which agrees well within 0.01 percent with the calibrated value of the standard.

15. The National Bureau of Standards Certificate

The following text of a certificate contains data from the test of a bridge of the make and model described in the preceding pages. (The heading

of the certificate and the identification of the bridge have been omitted.)

The above-described apparatus was tested in (month and year) at a room temperature of about _____ ° C. When the bridge is in a balanced condition, the value of the unknown resistance connected between the "X" terminals of the bridge is given in ohms by the following equation:

Here A is the nominal value of the resistor plugged to the A bar, B is the nominal value of the resistor plugged to the B bar, and a and b are the respective corrections to these nominal values expressed in proportional parts. The readings of the decades in the rheostat are denoted $R_1, R_2, R_3, R_4,$ and R_5 ; and $c_1, c_2, c_3, c_4,$ and c_5 are the respective corrections to these readings. The term 0.0009 is the resistance of that part of the bridge which is in series with the resistor being measured.

$$X = \frac{A}{B}(1+a-b)(R_1+c_1+R_2+c_2 + R_3+c_3+R_4+c_4+R_5+c_5) - 0.0009.$$

The corrections are given in the following tables:

Ratio resistors, $A, B,$ and corrections a, b

A or B	a	b
1	-0.0002	+0.0001
1'	-.0002	.0000
10	-.00001	-.00001
10'	-.00001	-.00001
100	+.00008	+.00008
100'	+.00010	+.00010
1 000	+.00008	+.00008
1 000'	+.00010	+.00010
10 000	+.00002	+.00002
10 000'	+.00003	+.00003

Rheostat arm

R_1	c_1	R_2	c_2	R_3	c_3	R_4	c_4
0	+0.007	0	0.000	0	0.000	0	0.000
1 000	+.16	100	-.002	10	-.002	1	.000
2 000	+.35	200	+.006	20	-.004	2	-.001
3 000	+.5	300	.00	30	-.008	3	-.001
4 000	+.5	400	+.01	40	-.007	4	-.002
5 000	+.6	500	+.01	50	-.013	5	-.002
6 000	+.6	600	+.02	60	-.018	6	-.003
7 000	+.8	700	+.04	70	-.014	7	-.003
8 000	+.9	800	+.05	80	-.019	8	-.003
9 000	+1.0	900	+.06	90	-.025	9	-.004

The corrections to the one-tenth ohm-per-step decade were found to be less than 0.0005. The corrections given above are not in error by more than 0.01 percent of the readings to which they apply for readings of 10 ohms or more, nor by more than 0.001 ohm for smaller readings; however, the corrections to the 1-ohm readings of the ratio arms are probably not in error by more than 0.0002 ohm. Other tests revealed no defects in the bridge.

Part 3. Testing General-Purpose Potentiometers

16. The Potentiometer—General Description

The dial and panel markings on different makes of potentiometers are usually clear. In this section, the following symbols will be used:

- Battery binding posts: BA+ and BA-
- Emf binding posts: EMF+ and EMF-, or E+ and E-
- Galvanometer: GA
- Standard cell: SC
- Standard cell binding posts: SC+ and SC- or STD CELL+ and STD CELL-
- Emf-standard cell dial or switch: EMF-SC.

16.1. The Potentiometer Circuit

The potentiometer is designed primarily to measure an unknown emf by comparing it with the known emf of a standard cell. The basic principle of the instrument may be understood from the schematic diagram, figure 50, which represents the potentiometer circuit when the galvanometer key is closed. When a battery is connected to the BA binding posts the ratio of the fall of potential across the emf segment of the circuit, E, to the fall of potential across the standard cell segment, S, is equal to the ratio of the resistances of the respective segments. It is immaterial if the segments, E and S, overlap.

A selector switch, the EMF-SC switch, not shown in the diagram, connects the standard-cell binding posts to the circuit when the switch is on SC, and connects the emf binding posts to the circuit when the switch is on EMF. A dial switch, the standard cell dial, is used to vary the resistance of segment S. Figure 50 shows the resistance variable at the SC+ end. In some potentiometers, it may be variable at the SC- end. If there are two SC dials, one for coarse, the other for fine adjustment, the segment is variable at both ends, with one dial switch at each end.

The graduations on the SC dial, or dials, cover the range of standard cells in common use. When the potentiometer is used to measure an unknown emf, the SC dial is set on the calibrated value of the standard cell in use.

The resistance of segment E of the potentiometer circuit is adjusted on the Crompton-type potentiometer by a main dial which varies the resistance at one end of the segment, and a slide-wire of eleven turns on a drum, which varies the resistance at the other end of the segment. A modification

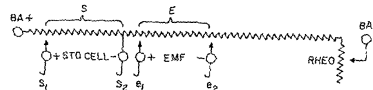

FIGURE 50. Simplified schematic diagram of potentiometer.

of the Crompton type replaces the long slide-wire with an intermediate dial and a slide-wire of one turn. Usually, the intermediate dial and the slide-wire vary the resistance at the same end of the segment. Other potentiometer types use several dials. The dials are graduated to indicate the value of the emf applied at the EMF binding post.

When a potentiometer is used for measurement a stable battery with the voltage specified by the maker is connected to the binding posts BA+ and BA-. A standard cell is connected to the standard cell binding posts and the unknown emf is connected to the emf binding posts. It is necessary to observe correct polarity. A sensitive galvanometer is connected to the galvanometer binding posts. There are usually three or more galvanometer keys ranging from low sensitivity to high sensitivity.

When the EMF-SC switch is set on SC, the emf of the standard cell imposed across the S segment is opposed by the emf across the E segment due to the current from the battery. The potentiometer current is adjusted by the rheostat (Rheo, fig. 50) until depression of the galvanometer key results in zero (or minimum) galvanometer deflection, indicating that the opposing emf's are equal and balanced. Only a very small current should be drawn momentarily from the standard cell. While making the current adjustment, a galvanometer key is depressed momentarily to observe the direction of deflection, beginning with the low-sensitivity key and changing in turn to other keys as it becomes necessary to observe the deflection. With perfect adjustment, there is no current from the standard cell.

The ideal zero deflection of a sensitive galvanometer is rarely obtainable. Hence, "zero deflection" will be used in the sense of the minimum deflection attainable by careful adjustment.

After the potentiometer has been "standardized" by balancing the emf due to the potentiometer current against the emf of the standard cell, the EMF-SC switch is set on EMF. This disconnects the standard cell from the circuit and connects the unknown emf across the E-segment (fig. 50) of the circuit. To measure the unknown emf, the main dial, or the dial with the largest step value, is adjusted first and the adjustment is finished with the slide-wire, or the dial with the smallest steps. The adjustment is complete when depression of the high-sensitivity button produces zero deflection of the galvanometer. Then the known emf is balanced by the emf across the segment due to the potentiometer current. The readings of the dials, after corrections have been made, express the value of the unknown emf.

The current in the potentiometer may be varied with the result that the instrument is re-standardized and the readings of the emf are incorrect. Without disturbing the setting of the emf dials, the EMF-SC switch may be set on

SC and the current checked. If the galvanometer shows that the circuit is not balanced, the current should be readjusted with the rheostat, the switch returned to EMF, and the measurements continued.

The simplified diagram of figure 50 represents the potentiometer as a single resistance circuit. Most general purpose potentiometers have one or two extra branches covering additional emf ranges. The branch required for a given measurement is selected by a range or factor switch. A variation is the use of a plug to connect the appropriate branch. With the circuit selector, switch, or plug, on 1, the main circuit, which covers the maximum range of the potentiometer, is in use. Since dial tests are made over the maximum range, no correction is required for factor 1. The maximum range of several models is from zero to 1.61 v.

With the circuit selector on 0.1 the range is reduced to one-tenth (zero to 0.161 v), and the indications of the emf dials are to be multiplied by 0.1.

A factor setting of 0.01 is usually included. At that factor, the range is correspondingly reduced and the dial readings are to be multiplied by 0.01.

The different factor settings do not affect the standard cell part of the circuit or the indications of the SC dial. The standardization of the potentiometer is the same for all factor settings, but should be done with the selector at the factor setting at which the potentiometer is to be used if possible.

As a result of necessary tolerances in manufacture and the inherent instability of resistors, the resistance components of a potentiometer rarely or never agree with their design values. Hence, when a potentiometer is used for the precise measurement of an unknown emf, corrections, which have been found by accurate testing, must be applied to both dial readings and factor settings.

17. Adaptability of the Universal Ratio Set to Testing Potentiometers

The test circuit for a potentiometer is shown schematically in figure 51 in which the Universal Ratio Set is represented as a slide-wire. Note the preferred connections of battery and galvanometer when four-terminal measurements are to be made in multiple settings. The test connections of the ratio set to a widely-used type of potentiometer are shown in figure 53.

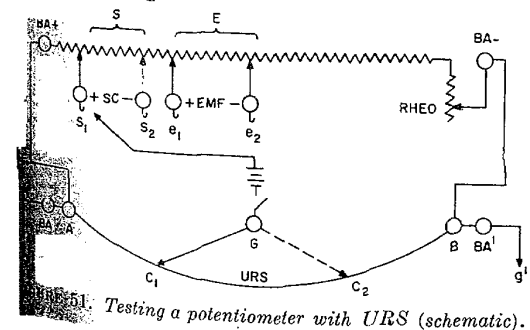

17.1. Measurement of Voltage Ratios

Let R_e and R_s be the resistances of segments E and S respectively, (figure 51), and let P_e and P_s be the voltage drops across the respective segments when a battery is connected to the terminals of the potentiometer. The potential points are the binding posts SC+, SC-, EMF+ and EMF-. The selector switch is on SC for measurements at SC+ and SC-, and on EMF for measurements at EMF+ and EMF-. Let S_1 , S_2 , e_1 , and e_2 be the URS readings taken at the respective potential points.

Then, from section 10.2,

$$\frac{P_e}{P_s} = \frac{R_e}{R_s} = \frac{e_2 - e_1}{S_2 - S_1}$$

$$P_e = P_s \times \frac{e_2 - e_1}{S_2 - S_1}$$

Assume that the SC dial is set on 1.019000 volts. Substituting 1.019000 for P_s ,

$$P_e = 1.019000 \times \frac{e_2 - e_1}{S_2 - S_1}$$

Generally, the potentiometer rheostat can be adjusted to make $S_2 - S_1 = 1.019.000$ (the setting of the standard cell expressed in millivolts). Then, in the same units,

$$P_s = S_2 - S_1$$

and

$$P_e = e_2 - e_1.$$

The URS is then "direct reading," that is, the difference in readings at two potential points may be interpreted directly as an emf without computation.

17.2. Interpretation of URS Readings

The Universal Ratio Set is primarily a resistance instrument with its dials usually graduated in ohms of resistance of the left ratio arm. Assume that the potential lead from the ratio set in figure 51 is connected to EMF+ and that the test circuit is balanced. Referring to the slide-wire counterpart of the URS, the slider on the wire is at C_1 . The reading of the dials of the URS is the resistance in ohms of the slide-wire segment, AC_1 . Using the earlier notation, call this Rdg_1 instead of e_1 . When the lead is transferred to EMF- and the circuit balanced, the reading of the URS dials is the resistance of AC_2 . Call this Rdg_2 . $Rdg_2 - Rdg_1$ is the resistance of the slide-wire segment, C_1C_2 . None of these resistances is a resistance of any known part of the potentiometer circuit, but $Rdg_2 - Rdg_1$ is proportional to the emf (P_e) across the segment. Therefore,

$$\text{emf} = K(Rdg_2 - Rdg_1),$$

in which K is a constant for any fixed value of current.

The current from a battery across the BA terminals of a potentiometer can be adjusted by the potentiometer rheostat. Generally, the rheostat can be adjusted so that the difference in URS readings taken at the SC binding posts is equal to the reading of the SC dial. Then

$$K=1$$

and

$$\text{emf} = \text{Rdg}_2 - \text{Rdg}_1.$$

This is the direct reading equation previously expressed in the form,

$$P_e = e_2 - e_1.$$

An outline of the procedure for making the URS direct reading will be found in section 18.

Assume that the SC dial is on 1.019000 v, that the URS is direct reading, and that URS readings taken at the SC potential points are as follows:

Rdg₁ 1 090.259 (resistance in ohms of AC₁)

Rdg₂ 2 109.259 (resistance in ohms of AC₂)

Difference 1 019.000 (resistance in ohms of C₁C₂)

The above difference corresponds to a difference of potential across segment S of the potentiometer circuit of 1 019.000 mv, equivalent to the setting of the SC dial of 1.019000 v. Therefore, readings on the URS are not to be thought of as resistances, but, if the URS is direct reading, the difference in two readings is to be interpreted as millivolts. This is equally true for readings taken across segment E.

Ignore the decimal point on the URS panel (that is, move it three places to the right) and the difference becomes microvolts. Point off six decimal places and the difference becomes volts. The above difference may be read as,

1.019000 v,
1 019.000 mv, or
1 019 000 μv.

The advantage of direct reading is that differences in URS readings at settings of the emf dials may be read directly as units of emf,—volts, millivolts, or microvolts, depending on whether six, three, or no decimal places are pointed off.

17.3. "Direct Reading" Versus "Not Direct Reading"

The following examples illustrate the difference in the work involved when the Universal Ratio Set is direct reading and when it is not. Six places have been pointed off in the URS readings so that the differences are expressed in volts.

Example 1. URS direct reading.

SC dial		Readings on URS
SC—	1.019000	1.119619
SC+	1.019000	.100619
	Difference	1.019000 v.
Main dial		Readings on URS
E—	0	.219777
E—	1.2	1.419590
	Difference	1.199813 v.

That is, a reading of 1.2 v on the potentiometer corresponds to a true value of 1.199813 v. The correction to the dial setting is
1.199813—1.200000=—0.000187 v
=—187 μv.

Example 2. URS not direct reading, from a test of another potentiometer of same type.

SC dial		Readings on URS
SC+	1.019000	0.101139
SC—	1.019000	1.126151
	Difference	1.025012

Since the difference is not the same as the setting of the SC dial it is not in volts.

Main dial		Readings on URS
E—	0	0.220884 (Rdg ₁)
E—	1.2	1.427907 (Rdg ₂)
	Difference	1.207023 (Rdg ₂ —Rdg ₁)

To change the latter difference to volts, use the equation

$$\text{emf} = K(\text{Rdg}_2 - \text{Rdg}_1) \\ = 1.207023K \text{ v.}$$

$$K = \frac{\text{Setting of SC dial}}{\text{Difference in readings at SC potential points}} \\ = \frac{1.019000}{1.025012} = 0.9941347.$$

Substituting the value of K in the equation
emf,

$$\text{emf} = 1.207023 \times 0.9941347 \\ = 1.199943 \text{ v,}$$

which is the measured value for a reading of v on the potentiometer. The correction to potentiometer reading is

$$1.199943 - 1.200000 = -0.000057 \text{ v} \\ = -57 \mu\text{v.}$$

In the test of the potentiometer from which data for example 2 were taken, there were readings which were multiplied by 0.99. Much tedious computation could have been avoided by making the URS direct reading.

17.4. General Outline of Test Procedures

The usual tests of a potentiometer are:

- a. Dial tests.
- b. Factor tests.
- c. Standard cell dial.

The connections of a Universal Ratio Set to the BA terminals of a potentiometer are shown in figure 53 and also in the schematic diagram, figure 51. Short tabs of bare copper wire at the SC and the EMF binding posts serve for convenient connection of an alligator clip on the end of the potential lead from the URS. The connections to the BA terminals of the potentiometer may be interchanged. Generally, two tests are made, by different observers, using different connections to the BA terminals. The URS readings in the two tests will differ, but the computed results should agree within the limits of observational error. The results of the two tests for each dial step and each factor are averaged to obtain the reported values.

17.4.a. Dial Tests

The URS may, or may not be direct reading. In either case, the potentiometer rheostat should not be changed during the dial tests. The URS readings at SC+ and SC- should be checked occasionally. Any appreciable change in the difference of the readings indicates a change in the resistance of the potentiometer circuit which may produce excessive errors in the readings. It may be necessary to repeat a dial test from the beginning.

A dial test should be made as rapidly as is consistent with careful work. If some time elapses between the tests on two dials, it may be necessary to readjust the potentiometer rheostat to make the URS direct reading for the test of the second dial; or, if the URS was not direct reading, it may be necessary to calculate a different factor for correction of the URS readings taken on the second dial.

The SC dial is set on 1.0190 for dial and factor tests, and the factor switch is set on 1.0 for the dial tests.

Readings at the SC potential points can be taken only if the EMF-SC switch is on SC. The difference in the readings should not change during the tests, though a variation of two or three units in the last place of a six dial ratio set is tolerable. The difference in the readings should be checked not less often than at the beginning and the end of each dial test.

The EMF-SC switch is set on EMF to take readings at each step on each dial, except that the slide-wire dial is tested at selected settings, at each fifty or each hundred dial units. While the dial is being tested the other emf dials remain at zero.

For each dial, readings are taken on the ratio set at E+ 0 and at E- 0, that is, with the dial on zero, readings are taken with the potential lead to E+ (EMF+) and E- (EMF-), respectively. These readings should not change significantly during the tests. One reading, say the reading at E- 0, is used as the zero reading for all emf dials.

The potential point for each succeeding step on the dial may be EMF+ or EMF-. The correct binding post may be found by trial. If the wrong post is selected, the readings on the ratio set will not change as the dial is advanced.

The record of the test should show the make and serial number of the instrument, the date and the room temperature at the time of test.

The record for each dial should show the potential point, the dial setting, and the URS reading for each step on the dial. The readings at the SC potential points should be recorded as well as the readings at the EMF potential points. For illustration, a partial record for the test of one potentiometer follows:

Main dial	URS
Dial setting	Reading
SC-	1 119 627
SC+	100 627
E+	219 782
E-	219 790
E-	319 769
E-	419 752
E-	519 736
etc.	

The readings on a ratio set usually need correction. The URS readings shown above are corrected readings. It is convenient, however, to record the readings while testing and apply the corrections later.

Readings on the ratio set taken during a dial test may increase or decrease as the dial is advanced, depending on which dial is tested and on the connections of the URS to the BA terminals of the potentiometer. In the above illustration the readings increase. The difference in the readings at SC- and SC+ is 1 019 000 μv or 1.019000 v, which shows that the URS was direct reading. Therefore, the correct value at any dial setting is the reading taken at the dial setting minus the zero reading. The zero reading is 219 790. The correct value for a dial setting 0.1 v is

$$319\ 769 - 219\ 790 = 99\ 979\ \mu\text{v}$$

or 0.099979 v and the correction is

$$0.099979 - 0.100000 = -0.000021\ \text{v}$$

or -21 μv .

A shortcut in computing corrections is to use only the last two or three digits of each reading. In the above example, subtraction of 90 (last two digits of zero reading) from the last two digits of

each succeeding reading gives the correction in microvolts:

Dial setting	Correction in microvolts
0.1	69-90=-21
.2	52-90=-38
.3	36-90=-54
etc.	

If the shortcut is used in computing corrections, it is important to note whether successive readings on the ratio set increase or decrease. In another test on the same dial the following readings were obtained:

Dial setting	URS reading
E- 0	1 891 342
E- 0.1	1 791 362
E- .2	1 691 378
E- .3	1 591 394
etc.	

In this example successive readings decrease. Therefore, each reading must be subtracted from the zero reading. The same order must be observed if the last two or three digits are used to compute corrections, as in the following.

Zero reading=1891342

Dial setting	Correction in microvolts
0.1	42-62=-20
.2	42-78=-36
.3	42-94=-52

If the corrections are quite large, it may be necessary to use the last three digits. The shortcut saves considerable computation and reduces the chance of making mistakes.

The differences in the results of the two tests are well within the limits of probable error. The last digit is uncertain. The average of the results for each dial step is rounded off and reported to the nearest 0.00001 v.

If the Universal Ratio Set is not direct reading, the certified corrections to the ratio set should be applied before the readings are multiplied by the factor, K . The determination of this factor and its use has been explained and illustrated by an example in section 17.3. The products of the corrected readings times the factor are equivalent to the corrected readings which would have been obtained if the URS had been direct reading and are to be used in the same way to find the dial corrections.

17.4.b. Factor Tests

Since the dial tests are made with the factor switch on 1.0, there is zero correction for factor 1.0. The other factor circuits are designed to change the indicated values of emf on the potentiometer dials by a factor of 0.1, or 0.01, when the factor switch is on the respective settings. As in all re-

sistance circuits, design values are subject to correction.

The design of the factor circuits in different makes and models of potentiometers differ widely. The test method to be outlined will apply to Crompton-type potentiometers and others of similar design.

The connection of the URS to the potentiometer is the same as for the dial tests. The potentiometer rheostat is set on minimum, the emf dials on maximum.

Let S_1 and S_2 represent readings on the URS taken at the SC potential points, and let e_1 and e_2 be the readings of the URS at the EMF potential points for a setting on factor 1.0.

Let $S_1', S_2', e_1',$ and e_2' be the corresponding readings for factor 0.1, and $S_1'', S_2'', e_1'',$ and e_2'' the corresponding readings for factor 0.01. Then

$$\text{factor } 0.1 = \frac{S_2 - S_1}{S_2' - S_1'} \times \frac{e_2' - e_1'}{e_2 - e_1}$$

$$\text{factor } 0.01 = \frac{S_2 - S_1}{S_2'' - S_1''} \times \frac{e_2'' - e_1''}{e_2 - e_1}$$

17.4.c. Standard Cell Dial

The object of this test is to detect any significant departure from a uniform change in resistance as the standard-cell dial is advanced in equal steps.

The EMF-SC switch is set on SC, the factor switch on 1.0, and the emf dials on zero. The correct potential point, SC+ or SC- may be found by trial. Beginning with the lowest setting of the SC dial, take readings on the URS for each four or five divisions on the dial. The readings of the URS should increase, or decrease about 100 (on a 6-dial ratio set) for each graduated division on the dial. The differences may vary by ± 2 or ± 3 per dial division.

17.5. Some Modifications of Procedure

The preceding general outline of test procedure applies, with minor modifications, to the dial tests of most potentiometers in common use. Attention will be given now to some of the problems which the worker may encounter.

It should not be assumed that the same potential point is correct for a given dial test of different makes of the same type. The determination of the potential point by trial has been explained. It is well to enter in the laboratory notebook, for future reference, the correct potential point for each model tested.

In section 18, detailed instructions for testing a selected model of the Crompton type include steps for making the URS direct reading. In the same steps, with a different model of potentiometer, may cause successive readings of the URS to diverge from instead of converge to 1.0. It will be necessary to interchange "SC" and "SC+" in the instructions, then follow the steps as outlined.

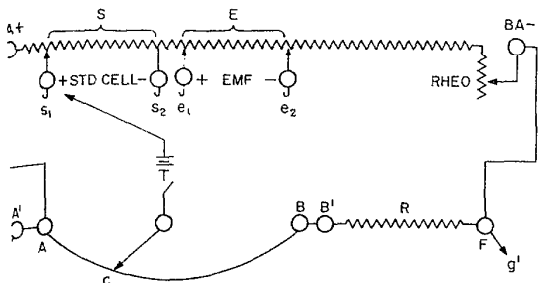

FIGURE 52. Testing a potentiometer with the range of the URS extended.

When testing some potentiometers, it is impossible to take readings on the URS for all settings of the potentiometer dials. This is due to extra resistance in the potentiometer circuit, which makes it necessary to extend the range of the URS by adding a resistance to the right hand end, as shown schematically in figure 52. The added resistance may be any laboratory-type dial box or plug box, which is stable in use, but it need not be calibrated. The required value may be several hundred ohms, which can be found by trial. The value should be entered in laboratory notes for reference when another potentiometer of the same kind has to be tested. Since the added resistance is a part of the modified URS circuit, the right-hand and galvanometer connection should be made between the resistance box and the potentiometer. The added resistance does not change the use of the URS readings to compute emf's.

It is impossible to make the URS direct reading on test some potentiometers. It is usually possible to adjust the potentiometer rheostat so that the difference in the URS readings at the standard potential points is some simple fraction (say one-half) of the standard value. The following readings were obtained in one test:

SC-1.019000	2.111068
SC+1.019000	1.601568
Difference	0.509500

Since the difference is exactly one-half of 0.019000, differences in readings taken at settings of the emf dials will be one-half the correct value. For example, readings taken at settings of the main dial were:

E-0	0.850104
E-1.5	.100081
Difference	.750023

$0.750023 = 1.500046$ v. That was the emf at a setting of 1.5 and the correction to the setting was $+40 \mu v$. Some types of potentiometers require special testing techniques. This is particularly true of the paper, to outline test procedures for all

The outline of general principles which has been given, together with the detailed procedures given in the next section for the test of a selected model, should serve as a guide to the test of most potentiometers in common use.

18. Details of Procedure As Applied to a Specific Model

18.1. Description of Potentiometer—Crompton Type

The main dial has a range in 0.1-v steps from 0 to 1.5 v. The slide-wire consists of a coil of eleven turns of resistance wire on a cylinder. A drum fitted over the cylinder can be rotated to move a contactor over the length of the wire. The edge of the drum is divided into 100 scale units, each of which is subdivided into two parts. A glass plate at the front of the drum has a scale which is read against the edge of the drum showing the number of rotations from 0 to 11. An index line on the glass plate is used to read the graduations on the edge of the drum. Each scale unit corresponds to 0.0001 v. The range of the slide-wire is from 0 to 0.1100 v. By estimating fifths of the smallest division on the drum, readings are obtained to one tenth of a scale unit or 0.00001 v.

The middle dial on the left of the potentiometer is the factor switch which may be set at any one of three points: 1, 0.1, or 0.01. Depending on the factor setting, the EMF measured is nominally 1, 0.1, or 0.01 times the reading on the scales.

The Std Cell dial is set to the calibrated EMF of the standard cell used when potentiometer measurements are made. For tests on the potentiometer, the dial is set on the nominal value, 1.0190.

The EMF-Std Cell switch connects the EMF leads or the standard cell leads into the circuit, depending on the setting of the switch.

The rheostat dials on the right end of the instrument adjust the current in the potentiometer circuit.

18.2. Test Equipment

Universal Ratio Set (URS), 6-dial or 5-dial
 Battery (3-6 v)
 Rheostat to regulate battery voltage
 Key (preferably with reversing switch)
 Sensitive galvanometer

18.3. Tests Required

Main dial—test each step to determine corrections.
 Slide-wire—test each 50 dial units to determine corrections.
 Standard cell dial—test each four divisions for linearity.
 Factor—test to find corrections for the 0.1 factor and the 0.01 factor.

Tests should be made at a temperature as near as possible to the temperature at which the potentiometer is to be used.



Universal Ratio Set connected for calibration of a potentiometer.

The detector is mounted between the two instruments and the test current is switched on and reversed by the operator's feet.

18.4. Points to Remember

1. Older models of Universal Ratio Sets are 5-dial. With a 5 dial set, it is desirable to interpolate one place.

2. The dial readings of most commercial Universal Ratio Sets require corrections. These corrections must be used for accurate results.

3. The galvanometer binding posts of the potentiometer must be shorted and the High GA Sens button must be depressed during tests.

4. Potential points and the EMF-Std Cell switch must agree; that is, the switch must be on EMF if an EMF potential point is in use, on Std Cell if a Std Cell potential point is in use.

5. The potential point for measurements on the main dial is EMF-; for measurements on the slide-wire, EMF+; for measurements on the Std Cell dial, Std Cell+.

6. The Std Cell dial should remain on 1.0190 except when testing that dial. Most standard cells have a nominal value of about 1.0190 v.

7. The battery rheostats of the potentiometer should remain unchanged after adjustment for direct reading on the URS, except to make factor tests.

8. All electrical connections must be clean and tight.

9. Turn the dials back and forth several times to wipe the contacts clean to reduce contact resistance. This applies to the URS as well as to the potentiometer.

18.5. Testing Procedures

18.5.a. Connections and Dial Settings

(a) Short the GA binding posts with a short piece of bare copper wire.

(b) Connect the BA binding posts of the potentiometer to the right and left binding posts of the URS as shown in figure 53.

(c) Connect the galvanometer leads to the extra end posts of the URS.

(d) Connect short pieces of bare copper wire between the Std Cell and the EMF binding posts to be used as potential points.

(e) Connect one battery lead to the middle post of the URS.

(f) The other battery lead should end in a spring clip to permit ready transfer from one potential point to another.

(g) Set the Std Cell dial on 1.0190.

(h) Depress the High GA Sens button and hold it down with a weight.

(i) Set the factor switch (middle dial on left) on "1."

(j) Set both the main dial and the slide-wire on zero.

18.5.b. To Make the URS "Direct Reading"

Set the EMF-Std Cell dial on Std Cell. On the right end of the potentiometer are three knobs which control a variable resistance or rheostat made up of three sections.

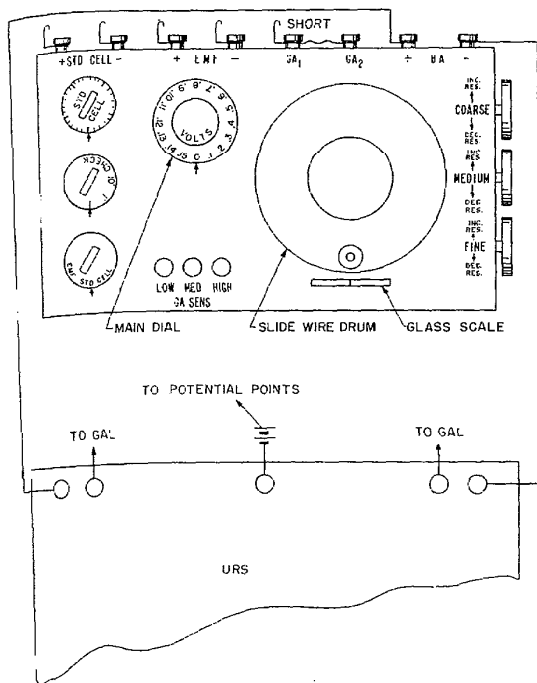

FIGURE 53. URS connected to a Crompton type potentiometer for testing.
Binding posts not used in tests are not shown in diagram.

adjustment, a medium adjustment, and a fine adjustment, as indicated on the panel. The arrows on the panel show in which direction to turn each knob to increase or decrease the resistance in the battery circuit. The purpose of the rheostat is to regulate the battery current to make the difference of potential between the SC binding posts equal to the reading of the Std Cell dial.

The URS will be "direct reading" when the rheostat is adjusted to make the difference between URS readings taken at the two Std Cell potential points equal to 1 019 000.

With the right side of the URS connected to the BA- binding post of the potentiometer and the circuit adjusted for direct reading, the reading of the URS will usually be near 1 119 600 with the battery clip at Std Cell- and near 100 600 with the battery clip at Std Cell+ (See table I, page 48). These settings will be time-saving guides for the adjustments.

With the battery clip connected to Std Cell-, turn the URS dials to 1 119 600 and adjust the rheostat on the potentiometer to get a zero deflection on the galvanometer when the battery clip is moved. Start with the coarse adjustment. When the current has been regulated as closely as possible with the coarse adjustment, proceed with the fine adjustment, and then the fine adjustment is impossible to get a zero deflection

of the galvanometer, adjust the rheostat for minimum deflection.

Next, move the battery clip to Std Cell+. Adjust the dials of the URS until the circuit is balanced (zero or minimum galvanometer deflection). If the URS is 5-dial, interpolate for the last digit of the reading. Add 1 019 000 to the dial reading obtained and set the dials of the URS on this value. Transfer the battery clip to Std Cell- and adjust the rheostat for zero deflection of the galvanometer.

Move the battery clip to Std Cell+ and repeat the adjustment of the URS dials as above.

Continue the proceeding, adjusting the rheostat when the battery clip is at the Std Cell- potential point and adjusting the URS dials when the battery clip is at the Std Cell+ potential point until the difference between the URS readings taken at the two potential points is 1 019 000. The adjustment usually can be made very accurately. If necessary, a tolerance of two or three units in the last place is permissible.

If there are any corrections to the dial readings of the URS, use the corrected readings for the final adjustment.

A second test should be made on a potentiometer to check the accuracy of measurement. For the second test, the connections between the potentiometer and the URS should be reversed, that is, if in the first test the right side of the URS was connected to the BA- post of the potentiometer, in the second test it should be connected to the BA+ post and the left side of the URS to the BA- post.

The procedure for direct reading will be the same as the preceding, except that 1 019 000 will be subtracted from the Std Cell+ reading to obtain the next setting on the URS for Std Cell-. The dial readings on the URS will be near 991 500 for the Std Cell- potential point and near 2 010 500 for the Std Cell+ potential point (see table II).

In each case, adjust the potentiometer rheostat on Std Cell-, the URS on Std Cell+.

It is convenient, though not necessary, that the URS be direct reading. The alternate procedure will be explained later.

18.6. Measurements on the Main Dial

- Set: Main dial and slide-wire on zero.
Std Cell dial on 1.0190.
Factor switch on 1.
EMF-Std Cell dial on Std Cell.

Take readings on the URS with potential points at Std Cell+ and at Std Cell- and record. If the URS is 5-dial, interpolate one place. If the URS is direct reading, the difference between these readings will be 1 019 000.

Change the EMF-Std Cell dial to EMF.

Take readings on the URS with potential points at EMF+ and at EMF-. Then with the potential point still at EMF-, take and record readings for each step of the main dial.

Set the main dial back to zero and repeat readings for Std Cell+, Std Cell-, EMF+ 0, and EMF- 0. These should not differ from the initial readings by more than five steps on the sixth dial of the URS.

18.7. Measurements on the Slide Wire

Initial dial settings as in section 18.6. Repeat the readings for Std Cell+, Std Cell-, EMF+, and EMF-. Remember to set the EMF-Std Cell dial on Std Cell when reading at a Std Cell potential point, on EMF when reading at an EMF potential point.

With the potential point at EMF+, take readings for each 50 dial units on the slide wire. When the slide wire is returned to zero, readings at Std Cell+, Std Cell-, EMF+, and EMF- should not have changed by more than five divisions on the sixth dial of the URS.

Correct the URS reading if corrections are required.

(A good practice is to record all readings in black, make all corrections and enter all results of computation in red.)

For a second test, on both the main dial and the slide wire, reverse the connections between the URS and the potentiometer and proceed as in the first test.

18.8. Measurements on the Standard Cell Dial

This is a test for linearity, that is, a test to find whether or not the steps on the dial correspond to uniform changes of resistance. With the potential point at Std Cell+, take readings for each four divisions on the dial. These readings (corrected) should decrease (or increase) uniformly. Deviations should be less than fifteen units on the URS.

18.9. Finding Corrections for the Main Dial

Following is the recorded data for a few steps on the potentiometer (URS readings are recorded without pointing off decimal places).

TABLE I. First test, with URS "direct reading" and side of URS to BA-.

I	IIa	IIb	I
SC- 10 190	1 119 629	1 119 627	1 01
SC+ 10 190	100 631	100 627	
EMF+ 0	219 782	219 782	-----
EMF- 0	219 790	219 790	-----
EMF- 0.1	319 772	319 769	-----
.2	419 756	419 752	-----
.3	519 740	519 736	-----
.4	619 726	619 716	-----
.5	719 709	719 701	-----
-----	-----	-----	-----
1.5	1 719 522	1 719 529	-----

Column I—Potential points and dial set
Column IIa—URS readings; column corrected URS readings.

Column III—The difference, 1 019 000, bet the Std Cell readings shows that the URS "direct reading." The other numbers in column are the corrections to the dial rea expressed in microvolts. These are fou the following procedure: The *reference vai* the reading for EMF-0. Since the URS rea increase each step, the *reference value* is tracted from the reading for each succe step, then the indicated value of the dial s is subtracted from the result to obtain the rection.

Dial step

0.1v 0.319769 - 0.219790 = 0.099979 or (0.1 - 0.000
0.2v 0.419752 - 0.219790 = 0.199962 or (0.2 - 0.000
0.3v 0.519736 - 0.219790 = 0.299946 or (0.3 - 0.000

And so on.

The computation is simplified by using the last two or three digits of the readin find the corrections:

0.1v 769-790 = -21 μv
0.2v 752-790 = -38 μv
0.3v 736-790 = -54 μv.

TABLE II. Second test, with connections between URS and potentiometer reversed.

I	IIa	IIb	III	IV	V
SC+ 10 190	2 010 488	2 010 494	1 019 000		
SC- 10 190	991 473	991 494			
EMF+ 0	1 891 317	1 891 349	-----	-----	-----
EMF- 0	1 891 310	1 891 342	0	0	0.00000
EMF- 0.1	1 791 334	1 791 362	-20	-21	-.00002
.2	1 691 355	1 691 378	-36	-38	-.00004
.3	1 591 368	1 591 394	-52	-54	-.00005
.4	1 491 398	1 491 412	-70	-74	-.00007
.5	1 391 415	1 391 431	-89	-89	-.00009
-----	-----	-----	-----	-----	-----
1.5	391 571	391 589	-247	-261	-.00025

Columns I, IIa, IIb, and III correspond to the first four columns in the tabulated data for the first test.

Since the readings decrease, subtract the URS reading for each step from the reading for zero to find the corrections in column III. For example, to find the correction for 0.3 v,

$$1.891342 - 1.591394 = 0.299948 \text{ or } (0.3 - 0.000052) \text{ volt.}$$

If only the last three digits of the readings are used,

$$342 - 394 = -52 \mu\text{v.}$$

Column IV contains the corresponding corrections found in the first test. Step by step, the corrections found in the two tests should not differ by more than 20 or 30 μv .

Column V shows the reported corrections as fractions of a volt. These were derived from the average of the results of the two tests for each step. The final digit was uncertain, so the value was rounded off to that shown in the table. The initial readings in the preceding tables and in those which follow may be useful, time-saving, guides for beginning a corresponding test on a Crompton-type potentiometer. As a rule these readings for different instruments by the same manufacturer do not differ greatly.

18.10. Finding Corrections for the Slide Wire

The tables for the slide wire which follow are similar to the corresponding tables for the main dial, hence, should need no further explanation.

TABLE III. First test with URS "direct reading" right side to BA-.

	I	IIa	IIb	III
SC-	10 190	1 119 629	1 119 627	1 019 000
SC+	10 190	100 631	100 627	
EMF-	0	219 790	219 790	0
EMF+	0	219 782	219 782	+8
EMF+	50	214 777	214 776	+14
	100	209 772	209 769	+21
	150	204 765	204 761	+29
	200	199 737	199 761	+29
	250	194 738	194 761	+29
	1 100	109 634	109 632	+158

The readings on the URS for the slide wire are taken at the potential point EMF+, but the reference point is EMF-0, the same as for the main dial.

The correction for EMF+0 was entered under "slide wire," only. It should not be entered twice.

TABLE IV. Second test, with connections between URS and potentiometer reversed.

	I	IIa	IIb	III	IV	V
SC+	10 190	2 010 485	2 010 494	1 019 000		
SC-	10 190	991 473	991 494			
EMF-	0	1 891 310	1 891 342	0	0	0.0
EMF+	0	1 891 317	1 891 349	+7	+8	+ .1
EMF+	50	1 896 323	1 896 356	+14	+14	+ .1
	100	1 901 348	1 901 353	+11	+21	+ .2
	150	1 906 358	1 906 364	+22	+29	+ .3
	200	1 911 358	1 911 366	+24	+29	+ .3
	250	1 916 368	1 916 377	+35	+29	+ .3
	1 100	2 001 489	2 001 495	+153	+158	+1.6

Column IV shows the corrections for each step found in the first test. These were averaged with the corrections in Column III and the value rounded off. The results were then entered in Column V as tenths of a dial unit on the slide wire. For example, the corrections found in the two tests for a setting of 250 were +35 and +29, respectively. The average was +32 μv , or +0.000032 v. The last digit was dropped as uncertain, giving +0.003 v. A dial unit on the slide wire is 0.003 v. Hence, the correction is +0.3 of a slide unit. This is the form in which it would

be used in the formula which will be presented later.

18.11. Tabulation of Data for Standard-Cell Dial

The potential point is Std Cell+. The measurements in the following table were made for every fourth dial division with the left side of the URS to BA-. The graduations on the dial were accepted as linear because the deviations from uniformity in the last column are within the range of experimental error.

TABLE V. Data from test of standard cell dial.

Std cell dial	URS	URS (corrected)	Differences
10 176	2 009 084	2 009 086	401
10 180	2 009 485	2 009 487	396
10 184	2 009 881	2 009 883	402
10 188	2 010 282	2 010 285	399
10 192	2 010 681	2 010 684	400
10 196	2 011 081	2 011 084	405
10 200	2 011 486	2 011 489	391
10 204	2 011 877	2 011 880	

18.12. Factors

The potentiometer has three ranges: the normal range (0 to 1.6100 v) with the factor switch set on "1," a range of one tenth the dial readings with the factor switch set on "0.1;" and a range of one hundredth the dial readings with the factor switch on "0.01." Imperfections in circuit compensation may require that corrections be applied to the factor readings. However, there will be no correction for the "1" factor because the dial corrections were determined at a factor setting of "1."

To find the factor corrections, set

Main dial and slide wire at maximum readings;

Battery rheostats of the potentiometer at minimum. However, back off the medium and fine rheostat dials somewhat from the end points because good contact may not be obtained at the end settings.

With potential points alternately at Std Cell+ and Std Cell-, take readings at each factor switch setting and find the difference between the Std Cell readings for each. (See tabulated example, table VI.)

With potential points alternately at EMF+ and EMF-, take readings for each factor switch setting and find the difference between the EMF readings for each.

Divide the difference between the Std Cell readings for factor 1 by the difference between the EMF readings for factor 1. Call this quotient Q1.

Divide the difference between the EMF readings for factor 0.1 by the difference between the Std Cell readings for factor 0.1. Call this quotient Q.1.

Divide the difference between the EMF readings for factor 0.01 by the difference between the Std Cell readings for factor 0.01. Call this quotient Q.01. Then

$$\text{The 0.1 factor} = Q1 \times Q.1$$

$$\text{The 0.01 factor} = Q1 \times Q.01$$

TABLE VI. Example: (Right side of URS to BA-).

Factor switch	1	0.1	0.01
Std Cell-	1 275 553	1 275 487	1 275 47
Std Cell+	114 627	114 637	114 62
Difference	1 160 926	1 160 850	1 160 84
EMF-	1 959 006	308 309	143 24
EMF+	124 908	124 899	124 90
Difference	1 834 098	183 410	18 34

The above URS readings are corrected values.

The 0.1 factor = Q1 x Q.1

$$= \frac{1\ 160\ 926}{1\ 834\ 098} \times \frac{183\ 410}{1\ 160\ 850} = 0.100006$$

This may be written "0.1(1+67 ppm)".

Hence, the Correction for the 0.1 factor is +67 ppm.

The 0.01 factor = Q1 x Q.01

$$= \frac{1\ 160\ 926}{1\ 834\ 098} \times \frac{18\ 339}{1\ 160\ 846}$$

$$= 0.00999961, \text{ or } 0.01 (1-39 \text{ ppm})$$

The correction for the 0.01 factor is -39 ppm

A second test with connections to the UR reversed gave:

correction for 0.1 factor +50 ppm
 correction for 0.01 factor -89 ppm

The average of the results for each factor was found and rounded off to give the following results:

TABLE VII.

Factor	Aver. cor. ppm	Reported correction
1		0.00000
0.1	+58	+ .00006
0.01	-64	- .0001

Experimental errors in the measurement of the 0.01 factor may amount to 100 ppm. Hence, four places are retained in the reported correction. The difference in the results of two tests for the 0.1 factor should be less than 50 ppm; for the 0.01 factor, the difference should be less than 20 ppm.

18.13. Application of Corrections

The meaning of the corrections reported on the preceding pages may be better understood by application to a hypothetical measurement. Assume that when the potentiometer was

measure an unknown EMF, the following readings were taken:

factor switch 0.1
main dial .3
slide wire 229.0

The formula is:

$$E = F(1+d)[R+c+0.0001(R_s+c_s)]$$

E is the potential difference between the "EMF" terminals of the potentiometer expressed in the same units as the standard cell used with the instrument. F , R , and R_s are the factor, main dial, and slide wire readings respectively; and d , c , and c_s are the corresponding corrections to these readings.

When the above readings and the corresponding corrections from the preceding tables are substituted in the formula, the result is:

$$E = 0.1(1 + .00006)[.3 - .00005 + .0001(229.0 + .3)].$$

$$E = 0.032290 \text{ v.}$$

18.14. Procedure When the URS Is Not "Direct Reading"

This is illustrated by a selection of data from the record of the main dial of another potentiometer. In the table which follows, column IIa shows the corrected readings of the URS. The difference of the Std Cell readings, 1 015 884, shows that the URS was not "direct reading." Hence, the numbers in column IIa must be multiplied by a correction factor to obtain the "direct reading" values recorded in column IIb. To find this factor, **divide 1 019 000 by the difference of the Std Cell readings.** In this test, the correction factor was

$$\frac{1\ 019\ 000}{1\ 015\ 884} = 1.003067.$$

This is the coefficient K used in section 17. Columns III, IV, and V correspond to columns of the same number in preceding tables.

TABLE VIII. Data for main dial, URS not "direct reading".

I	IIa	IIb	III	IV	V
SC-10 190	1 116 194	1 015 884			
SC+10 190	100 310	Mult. by 1.003067			
EMF+0	218 950	219 622			
EMF-0	218 952	219 624	0	0	0.00000
EMF-0.1	318 646	319 623	-1	-1	.00000
.2	418 338	419 621	-3	-2	.00000
.3	518 032	519 621	-3	-2	.00000
.4	617 726	619 621	-3	-2	.00000
.5	717 420	719 620	-4	-3	.00000
---	---	---	---	---	---
1.5	1 714 357	1 719 615	-9	-3	-.00001

The same procedure applies to the slide wire readings.

18.15. A Working Test

This is a spot check at one setting of the dials of the potentiometer, corrected according to the preceding tests. The connections of accessory equipment to the binding posts of the potentiometer are shown in figure 54. Other details of the panel of the potentiometer are shown in figure 53. The calibrated value of the standard cell is not important, nor is the setting of the standard cell

Connect a 2-v storage cell to the BA binding posts of the potentiometer according to the indicated polarity. Allow the current from the cell to flow long enough to become steady. This may require 3 or 4 hrs.

Connect a sensitive galvanometer to the EMF binding posts.

Connect one pair of end posts of a double-throw (DPDT) switch to the SC binding posts of the potentiometer. Connect the other pair of end posts of the switch to the EMF

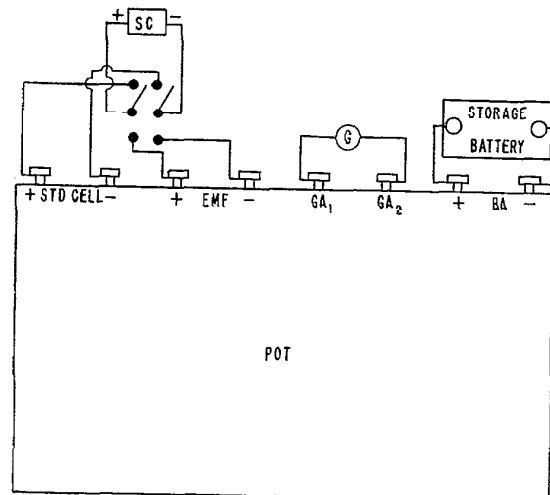

FIGURE 54. Working test.

binding posts. Make sure that both positive posts are connected to the same side of the switch. In figure 54 the left side of the DPDT switch is the positive side.

4. Take leads from the middle posts of the switch, to which the knife blades are attached, to the standard cell. Take care that the positive side of the switch is connected to the positive post of the cell. To avoid accidental short-circuiting of the cell, *make connections to the standard cell last*. When the test is finished, *disconnect the standard cell first*.

5. Set the factor switch of the potentiometer on 1.

6. Set the Std Cell dial on any convenient value, as 1.01900.

7. Set the EMF-Std Cell dial on Std Cell.

8. Set the main dial and slide wire to give the same reading as the Std Cell dial. Final adjustment to balance the circuit probably will require only a small change in the setting of the slide wire.

9. Throw the DPDT switch to connect the standard cell to the Std Cell binding posts.

10. Tap Low GA Sens key and observe the deflection of the galvanometer. Only a very small current should be drawn momentarily from the standard cell. The button should not be held down.

11. Adjust the current through the potentiometer with the potentiometer rheostat (knobs on the right hand end), until there is no deflection (or minimum deflection) of the galvanometer when the galvanometer key is depressed. Start with the coarse adjustment, then the medium, and then the fine adjustment.

12. Continue adjustment of the rheostat using the low, med, and high GA sens keys in succession, until the galvanometer shows that the emf is balanced by the emf across the standard cell segment of the potentiometer circuit. It may be impossible to get *perfect* current regulation. Set the fine adjustment to get the smallest possible deflection of the galvanometer. Do not change the current adjustment during the next step of the test.

13. Immediately, throw the DPDT switch to connect the standard cell to the EMF binding posts. Balance the circuit with the emf dials of the potentiometer. It will usually be necessary to change the setting of the slide wire only, using the galvanometer sensitivity keys in succession as in paragraph 12 above.

14. When the circuit is balanced, record the readings of the main dial and the slide wire. Estimate the reading on the slide wire to one tenth of a scale unit (one fifth of a division). Reset the switches (DPDT and EMF-Std Cell) on Std Cell and check for any change in the potentiometer current. If it has changed significantly, readjust the rheostat, return the switches to EMF, and repeat the adjustment of the slide wire. If there is a readable change in the setting of the slide wire, it is probable that more time is needed for the current in the potentiometer to become steady. Make another trial and repeat trials until slide wire readings can be repeated.

15. After the final reading, apply the relevant corrections found in the preceding dial tests to the readings of the main dial and slide wire. Compute the emf. Since the factor is 1 with zero correction, the equation for E becomes

$$E = R + c + 0.0001 (R_s + c_s)$$

Compare the result with the reading of the SC dial. Unless the potentiometer is defective, or there is some fault in the results of the preceding tests, the two values will agree quite closely.

Two trials of the working test which were made on the same potentiometer using different standard cells and different standard cell dial settings gave the following results:

First Trial

R , reading of main dial	1.0
c , correction to main dial reading	-0.00006
R_s , reading of slide wire	191.2
c_s , correction to slide wire rdg.	+0.1
E , (from equation)	1.01907
Setting of SC dial	1.01906
Difference	0.00001

Second Trial

R , reading of main dial	1.0
c , correction to main dial reading	-0.00006
R_s , reading of slide wire	192.3
c_s , correction to slide wire rdg.	+0.1
E , (from equation)	1.01917
Setting of Std Cell dial	1.01916
Difference	0.00001

Note that the results of the working test are independent of the calibrated value of the standard cell and the setting of the standard cell dial.

19. Sample Certificate for Crompton Potentiometer

UNITED STATES DEPARTMENT OF COMMERCE

NATIONAL BUREAU OF STANDARDS
WASHINGTON 25, D.C.

NATIONAL BUREAU OF STANDARDS

CERTIFICATE

for

POTENTIOMETER

(Maker)-----Serial No.-----

Submitted by

Tests of the adjustments of the main dial, the standard-cell dial, the slide-wire, and the factors of the above-described apparatus were made in (date), at a room temperature of about _____° C. With the current adjusted so as to produce a potential difference between the standard-cell terminals equal to the reading of the standard-cell dial, the potential difference between the "E.M.F." terminals can be expressed by the following equation:

$$E = F(1 + d)[R + c + 0.0001(R_s + c_s)]$$

Here E is the potential difference between the "E.M.F." terminals expressed in the same units as the electromotive force of the standard cell used with the instrument; F , R , and R_s are the factor, main dial, and slide-wire readings respectively; and d , c , and c_s are the corrections to these readings. The corrections are to be taken from the following tables.

Factor Switch Reading F and Correction d

F	d
1	0.00000
0.1	+ .00006
0.01	- .0001

Main Dial Reading R and Correction c

R	c	R	c
0.0	0.00000	0.8	-0.00014
.1	- .00002	.9	- .00016
.2	- .00004	1.0	- .00018
.3	- .00005	1.1	- .00019
.4	- .00007	1.2	- .00021
.5	- .00009	1.3	- .00022
.6	- .00011	1.4	- .00024
.7	- .00012	1.5	- .00025

Slide Wire Reading R_s and Correction c_s

R_s	c_s	R_s	c_s
0	+0.1	550	+0.9
50	+ .1	600	+ .9
100	+ .2	650	+1.0
150	+ .3	700	+1.1
200	+ .3	750	+1.2
250	+ .3	800	+1.2
300	+ .4	850	+1.4
350	+ .5	900	+1.3
400	+ .5	950	+1.5
450	+ .7	1000	+1.5
500	+ .7	1050	+1.6
		1100	+1.6

Values obtained by use of the above equation and corrections are not in error by more than 0.01 percent if R is equal to or greater than 0.2, nor by more than 0.4 of the smallest subdivision of the slide-wire for smaller values of R .

To obtain this accuracy, however, in case E is less than 0.02 volt, usually it will be necessary to correct for thermoelectromotive forces within the potentiometer and within the circuit of the connected galvanometer.

When the reading of the factor switch is changed, the current through the potentiometer should be readjusted, if necessary, to produce a potential difference between the standard-cell terminals equal to the reading of the standard-cell dial.

Other tests revealed no defects in the potentiometer.

For the Director

