

Spectral Data and Grotrian Diagrams for Highly Ionized Iron, Fe VIII-XXVI

Toshizo Shirai and Yoshio Funatake

Japan Atomic Energy Research Institute, Tokai-mura 319-11, Japan

Kazuo Mori

Hiroshima Denki Institute of Technology, Hiroshima 739-03, Japan

Jack Sugar and Wolfgang L. Wiese

National Institute of Standards and Technology, Gaithersburg, MD 20899

Yohta Nakai

Japan Atomic Energy Research Institute, Tokai-mura 319-11, Japan

Received March 30, 1989; revised manuscript received August 1, 1989

Wavelengths, energy levels, level classifications, oscillator strengths, and atomic transition probabilities for the iron ions Fe VIII to Fe XXVI are critically reviewed and tabulated. Grotrian diagrams are also presented to provide graphical overviews. The literature has been surveyed to March 1988.

Key words: atomic data; energy levels; grotrian diagrams; iron; oscillator strengths; spectra; transition probabilities; wavelengths.

Contents

1. Introduction	128	Fe XIX (O-sequence)	163
1.1. References for the Introduction	128	Fe XX (N-sequence)	165
2. Brief Comments on Each Iron Ion	128	Fe XXI (C-sequence)	168
3. Explanation of Tables of Spectroscopic Data	137	Fe XXII (B-sequence)	171
4. Spectroscopic Data for Fe VIII-Fe XXVI	138	Fe XXIII (Be-sequence)	174
5. Explanation of Grotrian Diagrams	181	Fe XXIV (Li-sequence)	177
6. Grotrian Diagrams for Fe VIII-Fe XXVI	182	Fe XXV (He-sequence)	179
7. References for Tables and Comments	273	Fe XXVI (H-sequence)	180
8. Acknowledgments	275		

List of Tables of Spectroscopic Data

Fe VIII (K-sequence)	138
Fe IX (Ar-sequence)	139
Fe X (Cl-sequence)	141
Fe XI (S-sequence)	143
Fe XII (P-sequence)	145
Fe XIII (Si-sequence)	148
Fe XIV (Al-sequence)	150
Fe XV (Mg-sequence)	151
Fe XVI (Na-sequence)	154
Fe XVII (Ne-sequence)	157
Fe XVIII (F-sequence)	160

List of Grotrian Diagrams

Fe VIII (K-sequence)	182
Fe IX (Ar-sequence)	184
Fe X (Cl-sequence)	188
Fe XI (S-sequence)	193
Fe XII (P-sequence)	196
Fe XIII (Si-sequence)	200
Fe XIV (Al-sequence)	205
Fe XV (Mg-sequence)	208
Fe XVI (Na-sequence)	214
Fe XVII (Ne-sequence)	221
Fe XVIII (F-sequence)	228
Fe XIX (O-sequence)	233
Fe XX (N-sequence)	238
Fe XXI (C-sequence)	244
Fe XXII (B-sequence)	251
Fe XXIII (Be-sequence)	257
Fe XXIV (Li-sequence)	264

©1990 by the U. S. Secretary of Commerce on behalf of the United States. This copyright is assigned to the American Institute of Physics and the American Chemical Society.

Reprints available from ACS; see Reprints List at back of issue.

Fe XXV (He-sequence)	268
Fe XXVI (H-sequence)	272

1. Introduction

Emission lines of highly ionized ions of the iron group elements, Ti, Cr, Fe and Ni, are used for diagnostics of high temperature plasmas with central electron temperatures up to the keV range. In order to facilitate their identification, the wavelengths, energy levels and level classifications, intensities, oscillator strengths, and radiative transition probabilities for such lines have been compiled for the spectra Fe VIII–Fe XXVI. This compilation is presented in the form of tables and Grotrian diagrams to allow a quick survey of the principal features of the levels and transitions in various ions.

In the past ten years numerous experimental studies have been made of the ionic spectra of iron. The comprehensive compilation of iron data by Mori *et al.* (1979)¹ has therefore been updated in the present work, including extensive revisions and additions based on the new studies. In addition, we have published compilations^{2–4} for the titanium, nickel, and molybdenum ions.

For the present compilation of Fe VIII–Fe XXVI, all the relevant papers published through March 1988 were collected and surveyed, and the best measurements and calculations, in our judgment, were included in the tables. We consulted the following comprehensive compilations: Kelly and Palumbo (1974)⁵ for wavelength data; Lawson *et al.* (1981)⁶ for $n=2-2$ transitions; Eidelsberg *et al.* (1981)⁷ for forbidden lines in astronomical sources; and Kaufman and Sugar (1986)⁸ for forbidden lines arising within ground configurations of the type ns^2np^k ($n=2$ and 3 , $k=1$ to 5), and two review articles by Fawcett in 1974⁹ and 1984¹⁰. However, these compilations and review articles are not cited as data sources for wavelengths.

In the following section we will give brief comments on each ion, including comments on the accuracy of the wavelength data. Recently Sugar and Corliss (1985)¹¹ published a comprehensive critical compilation of energy levels of the iron group elements in all stages of ionization. Their level values are adopted in this compilation, except where superseded by more recent data.

Since 1980, calculations of transition probabilities in various approximations have been reported for allowed and forbidden transitions, including multi-configuration Dirac-Fock calculations for the Cl-, P-, Si- and Al-sequence ions by Huang *et al.* (1983)¹², and Huang (1984)¹³, (1985)¹⁴, and (1986)¹⁵. A brief review of the theoretical data is given in the critical data compilations of allowed and forbidden lines by Fuhr *et al.* (1988)¹⁶. We have taken the oscillator strength and transition-probability data from a critical data compilation of allowed lines by Fuhr *et al.* (1981)¹⁷, supplemented by the new material in Ref. 16. The transition probability data for all magnetic dipole lines have been taken from Kaufman and Sugar (1986)⁸.

In cases where no experimental wavelength data are available, but for which transition probability data exist, the wavelengths are calculated from the energy levels of Sugar and Corliss (1985)¹¹ by using the Ritz combination principle.

Following the traditional custom of reporting wavelengths in the literature, we give values in air above 2000 Å and in vacuum below 2000 Å. For conversion of ionization energies from cm^{-1} to eV, we use the conversion factor $8065.5450(0.0054) \text{ cm}^{-1}/\text{eV}$ given by Taylor¹⁸.

1.1. References for the Introduction

- ¹K. Mori, M. Otsuka and T. Kato, *Atomic Data and Nuclear Data Tables* **23**, 195 (1979).
- ²K. Mori, W. L. Wiese, T. Shirai, Y. Nakai, K. Ozawa and T. Kato, *Atomic Data and Nuclear Data Tables* **34**, 79 (1986).
- ³T. Shirai, K. Mori, J. Sugar, W. L. Wiese, Y. Nakai, and K. Ozawa, *Atomic Data and Nuclear Data Tables* **37**, 235 (1987).
- ⁴T. Shirai, Y. Nakai, K. Ozawa, K. Ishii, J. Sugar, and K. Mori, *J. Phys. Chem. Ref. Data* **16**, 327 (1987).
- ⁵R. L. Kelly and L. J. Palumbo, *Atomic and Ionic Emission Lines below 2000 Angstroms: Hydrogen through Krypton*, NRL Report 7599 (1973).
- ⁶K. D. Lawson, N. J. Peacock and M. F. Stamp, *J. Phys. B* **14**, 1929 (1981).
- ⁷M. Eidelsberg, M. Crifo-Magnant and C. J. Zeippen, *Astron. Astrophys. Suppl. Ser.* **43**, 455 (1981).
- ⁸V. Kaufman and J. Sugar, *J. Chem. Phys. Ref. Data*, **15**, 321 (1986).
- ⁹B. C. Fawcett, *Adv. Atom. Molec. Phys.* **10**, 233 (1974).
- ¹⁰B. C. Fawcett, *J. Opt. Soc. Am. B* **1**, 195 (1984).
- ¹¹J. Sugar and C. Corliss, *J. Phys. Chem. Ref. Data* **14**, Suppl. 2, (1985).
- ¹²K.-N. Huang, Y.-K. Kim, K. T. Cheng and J. P. Desclaux, *Atomic Data and Nuclear Data Tables* **28**, 355 (1983).
- ¹³K.-N. Huang, *Atomic Data and Nuclear Data Tables* **30**, 313 (1984).
- ¹⁴K.-N. Huang, *Atomic Data and Nuclear Data Tables* **32**, 503 (1985).
- ¹⁵K.-N. Huang, *Atomic Data and Nuclear Data Tables* **34**, 1 (1986).
- ¹⁶J. R. Fuhr, G. A. Martin and W. L. Wiese, *J. Phys. Chem. Ref. Data* **17**, Suppl. 4 (1988).
- ¹⁷J. R. Fuhr, G. A. Martin, W. L. Wiese, and S. M. Younger, *J. Phys. Chem. Ref. Data* **10**, 305 (1981).
- ¹⁸E. R. Cohen and B. N. Taylor, *Rev. Mod. Phys.* **59**, 1121 (1987).

2. Brief Comments on Each Iron Ion

Fe VIII (K-Sequence)

Ground state: $1s^2 2s^2 2p^6 3s^2 3p^6 3d^2 D_{3/2}$

The $3p^6 3d - 3p^5 3d^2$ transition array in the wavelength region above 167 Å was first identified by Gabriel *et al.* (1965)¹⁰⁹ and Cowan and Peacock (1965)³⁸. Wavelengths with an uncertainty of ± 0.003 Å were measured by Ramonas and Ryabtsev (1980)¹⁶⁸ for this array.

Cowan (1967)³⁹ ascribed 17 solar lines in the range 112–121 Å observed by Feldman and Fraenkel (1966)⁹² to the $3p^6 3d - 3p^5 3d 4s$ array. Ramonas and Ryabtsev¹⁶⁸ also identified 22 lines in this wavelength range. Their wavelengths are adopted in this compilation. In addition, wavelength values of 120.31 and 114.05 Å for the $^2D_{5/3} - (^3P^o)^4P_{3/2}^o$ and $^2D_{3/2} - (^3D^o)^4D_{5/2}^o$ transitions are included from Cowan's identifications.

The measurements of $4p-5s$, $4p-6s$, $3d-4p$, and $3d-nf$ ($n=4-7$) transitions were published by Kruger and Weissberg (1937)¹⁴⁴. The $4p-5s$ and $4p-6s$ line identifications were shown to be incorrect by Alexander *et al.* (1965)² who also remeasured the $3d-6f$ and $3d-7f$ transition lines. The $3d-4f$ lines were observed in solar flares by Behring *et al.* (1972)³ and Malinovsky and Heroux (1973)¹⁵². The wavelengths for $3d-4p$ and $3d-nf$ ($n=4$ to 7) transitions are from Ramonas and Ryabtsev.

Oscillator strengths and transition probabilities are taken from the critical data compilation of Fuhr *et al.* (1981)¹⁰⁷.

Fe ix (Ar-Sequence)

Ground state: $1s^2 2s^2 2p^6 3s^2 3p^6 \ ^1S_0$

From solar spectrum observations, Sandlin *et al.* (1977)¹⁷² identified the following 4 lines due to magnetic-dipole (M1) transitions within the $3p^5 3d$ configurations: $^3F_4^o-^1F_3^o$ at 2497.5 Å (in air), $^3P_2^o-^3D_2^o$ at 2042.35 ± 0.01 Å (in air), $^3P_1^o-^3D_2^o$ at 1841.57 ± 0.02 Å and $^3P_2^o-^1F_3^o$ at 1917.21 ± 0.02 Å. These wavelengths are in good agreement with those of Feldman and Doschek (1977)⁹⁸.

Svensson *et al.* (1974)¹⁸⁴ assigned 5 coronal lines in the range 171–245 Å, observed by Behring *et al.* (1972)³, to the $3p^6-3p^5 3d$ resonance transitions. Using the known levels of $3p^5 3d$, they identified 10 coronal M1 lines. Edlén and Smitt (1978)⁵⁷ rederived energies for the $3p^5 3d$ levels from lines observed by Jefferies (1969)¹²⁴, Jefferies *et al.* (1971)¹²⁵ and Sandlin *et al.*¹⁷², utilizing new improved solar observations of the resonance transitions by Behring *et al.* (1976)⁴. Seven M1 lines above 3000 Å with an uncertainty of ± 0.4 Å are from Ref. 125 and an additional M1 line at 3000 Å (in air) is taken from Ref. 124.

Smitt and Svensson (1983)¹⁷⁸ published 19 wavelengths in the range 311–605 Å for the $3s^2 3p^5 3d-3s 3p^6 3d$ transitions. The uncertainty of the wavelengths is ± 0.01 Å.

The $3p-4s$ transitions were first identified by Kruger *et al.* (1937)¹⁴⁵. There are many solar observations of these lines including the work of Zirin (1964)²⁰¹ and Feldman *et al.* (1965)⁹¹. The wavelength values of 103.566 and 105.208 Å are from Fawcett *et al.* (1972)⁷².

The $3p^6 \ ^1S_0-3p^5 4d \ ^3P_1^o$ and $^1P_1^o$ transitions were first identified by Alexander *et al.* (1965)², whose wavelength values were revised as 83.457 and 82.430 Å by Fawcett *et al.*⁷²

Wagner and House (1971)¹⁹³ measured 12 wavelengths in the range 111–117 Å with an uncertainty of ± 0.02 Å and ascribed them to the $3p^5 3d-3p^5 4f$ transitions. More accurate measurements of 9 of them, with an uncertainty of ± 0.007 Å, were made with a laboratory plasma by Fawcett *et al.*⁷², whose wavelengths are tabulated. Wavelengths for the other transitions, including an additional transition $3p^5 3d \ ^1F_3^o-3p^5 (^3P_{3/2}^o) 4f [^7/2]_4$ at 118.27 Å, are taken from Swartz *et al.* (1976)¹⁸⁶.

Alexander *et al.*² identified two lines at 72.85 and 73.63 Å as the $3p^6 \ ^1S_0-3p^5 5s (^1/2, ^1/2)_1^o$ and $3p^6 \ ^1S_0-3p^5 5s (^3/2, ^1/2)_1^o$ transitions.

The resonance transition from the $3s 3p^6 4p \ ^1P_1^o$ level at 72.891 ± 0.005 Å was identified by Kastner *et al.* (1977)¹³³.

Oscillator strengths and transition probabilities are taken from the critical data compilation of Fuhr *et al.* (1981)¹⁰⁷.

Fe x (Cl-Sequence)

Ground state: $1s^2 2s^2 2p^6 3s^2 3p^5 \ ^2P_{3/2}^o$

The M1 line due to the $3s^2 3p^5 \ ^2P_{3/2}^o-^2P_{1/2}^o$ transition was reported by Grotrian (1939)¹¹⁴. We adopted the wavelength 6374.51 Å (in air) from this article. The analysis by Smitt (1977)¹⁷⁷ resulted in the identification of seven lines of the multiplet $3s^2 3p^4 3d \ ^4D-3s 3p^5 (^3P^o) 3d \ ^4F^o$ and nine of $3s^2 3p^4 (^3P) 3d \ ^4F-3s 3p^5 (^3P^o) 3d \ ^4F^o$ in the ranges 317–325 Å and 354–367 Å, respectively. From the determined intervals, he identified 11 coronal lines as due to M1 transitions within the $3s^2 3p^4 3d$ configuration. Edlén and Smitt (1978)⁵⁷ improved the level values with the wavelengths of Jefferies *et al.*¹²⁵ and Magnant-Crifo (1973)¹⁵¹ above 3000 Å and of Sandlin *et al.* (1977)¹⁷² below 3000 Å.

The $3s^2 3p^5 \ ^2P_{1/2,3/2}^o-3s 3p^6 \ ^2S_{1/2}$ transitions were identified by Fawcett (1971)⁷⁰ in a laboratory plasma and by Widing *et al.* (1971)¹⁹⁵ in the solar corona. More accurate wavelengths of 365.543 ± 0.008 Å and 345.723 ± 0.008 Å for these transitions were measured by Smitt *et al.* (1976)¹⁷⁶

An analysis of the $3p^5-3p^4 3d$ array was made by Fawcett and Gabriel (1966)⁶² and Smitt *et al.*¹⁷⁷. It was extended by Bromage *et al.* (1977)²¹ who used wavelengths of solar coronal lines measured by Behring *et al.* (1972, 1976)^{3,4}.

The $3p^5-3p^4 s$ transitions in the range 94–98 Å were identified by Edlén (1937)⁵⁵. His measurements are quoted.

Wavelengths of the $3p^4 3d-3p^4 4p$, $3p^5-3p^4 d$ and $3p^4 3d-3p^4 f$ transitions were observed by Fawcett *et al.* (1972)⁷² in the range of 75–145 Å in a laboratory plasma with an accuracy of ± 0.01 Å.

The tabulated oscillator strengths and transition probabilities for electric-dipole (E1) and M1 transitions are taken from the critical data compilations of Fuhr *et al.* (1981)¹⁰⁷, Fuhr *et al.* (1988)¹⁰⁸, and Kaufman and Sugar (1986)¹³⁵.

Fe xi (S-Sequence)

Ground state: $1s^2 2s^2 2p^6 3s^2 3p^4 \ ^3P_2$

Grotrian (1939)¹¹⁴ identified a solar line at 7891 Å (in air) as the $3s^2 3p^4 \ ^3P_2-^3P_1$ transition. Edlén (1942)⁵⁶ con-

firmed this identification and ascribed a line at 3986.9 Å (in air) in the solar corona to the $3s^23p^4\ ^3P_1-^1D_2$ transition. Wavelengths of 7891.8 Å (in air) and 3986.8 Å (in air) are taken from improved measurements with an accuracy of ± 0.4 Å by Jefferies *et al.* (1971)¹²⁵. Sandlin *et al.* (1977)¹⁷² observed two solar coronal lines at 1467.06 Å and 2648.71 Å (in air) with accuracies of ± 0.01 Å and ± 0.02 Å, respectively, and identified them as due to the $3s^23p^4\ ^3P_1-^1S_0$ and $^3P_2-^1D_2$ transitions.

The $3s^23p^4\ ^3P-3s3p^5\ ^3P^o$ triplet in the wavelength range 341–370 Å was identified in a laboratory plasma by Fawcett (1971)⁷⁰ and in the solar corona by Widing *et al.* (1971)¹⁹⁵. Smitt *et al.* (1976)¹⁷⁶ carried out improved measurements of these lines with an uncertainty of ± 0.008 Å. He also identified a new line at 355.837 Å as the $3s^23p^4\ ^1S_0-3s3p^5\ ^1P_1^o$ transition and attributed a line at 308.544 Å observed by Behring *et al.* (1976)⁴ to the $3s^23p^4\ ^1D_2-3s3p^5\ ^1P_1^o$ transition.

Classifications of the $3p^4-3p^33d$ transitions in the range 176–202 Å were provided by Gabriel *et al.* (1966)¹¹⁰, Fawcett and Gabriel (1966)⁶², and Fawcett (1971)⁷⁰ in laboratory plasmas. A more comprehensive classification, with the use of solar wavelengths with an accuracy of ± 0.008 Å by Behring *et al.* (1972)³, was reported by Bromage *et al.* (1977)²¹. They included newly identified lines in the spectrum analyzed earlier by Fawcett⁷⁰.

Edlén (1937)⁵⁴ identified 12 lines in the range of 86–91 Å as $3p^4-3p^34s$ transitions. As later noted by Edlén⁵⁶, the classifications of the lines at 86.149 Å $3p^4\ ^3P_2-3p^3(^2D^o)4s\ ^1D_2^o$ and at 89.771 Å as $3p^4\ ^1D_2-3p^3(^2D^o)4s\ ^3D_3^o$ are incorrect.

Fawcett (1972)⁷² classified the $3p^33d-3p^34p$, $3p^33d-3p^34f$, and $3p^4-3p^34d$ transitions in the ranges 121–125 Å, 91–94 Å, and 72–73 Å, respectively. The uncertainty of the wavelengths is ± 0.01 Å.

Semi-empirical oscillator strengths for the $n=3-3$ and $3-4$ transitions were published by Fawcett (1986)⁸⁵. The tabulated oscillator strengths and transition probabilities for E1 and M1 transitions are taken from the critical data compilations of Fuhr *et al.* (1981)¹⁰⁷ and Kaufman and Sugar (1986)¹³⁵.

Fe XII (P-Sequence)

Ground state: $1s^22s^22p^63s^23p^3\ ^4S_{3/2}^o$

Forbidden transitions between terms in the ground configuration were observed in the solar corona. The $^4S^o-^2P^o$ transitions were identified by Burton *et al.* (1967)³¹, Burton and Ridgeley (1970)³², and Doschek *et al.* (1976)⁴⁹. Gabriel *et al.* (1971)¹¹¹ identified the line at 2169.7 Å (in air) as the $^4S_{3/2}^o-^2D_{5/2}^o$ transition as well as to the above transitions. More comprehensive observations were made by Sandlin *et al.* (1977)¹⁷², who identified five M1 transitions: $^2D_{3/2}^o-^2P_{3/2}^o$ at 2565.93 ± 0.06 Å (in air), $^4S_{3/2}^o-^2D_{3/2}^o$ at 2405.68 ± 0.01 Å (in air), $^4S_{3/2}^o-^2D_{5/2}^o$ at 2169.08 ± 0.02 Å (in air), $^4S_{3/2}^o-^2P_{1/2}^o$ at 1349.40 ± 0.01 Å,

and $^4S_{3/2}^o-^2P_{3/2}^o$ at 1242.00 ± 0.01 Å. For the $^2D_{3/2}^o-^2P_{1/2}^o$ transition, Svensson (1971)¹⁸³ assigned the line of 3072.0 Å (in air) measured by Jefferies *et al.* (1971)¹²⁵.

The classification of the $3s^23p^3-3s3p^4$ transitions in the range 283–383 Å was given by Fawcett (1970)⁶⁸ from observations of a laser produced plasma. Widing *et al.* (1971)¹⁹⁵ classified the $^4S^o-^4P$ array, in addition to the $^2D_{5/2}^o-^4D_{5/3}$ transition observed in the solar corona. Fawcett (1971)⁷⁰ and Behring *et al.* (1976)⁴ obtained wavelengths with an uncertainty of ± 0.05 Å from a laboratory plasma, and with an uncertainty of ± 0.04 Å from the solar corona. Three wavelengths, 382.83, 335.06, and 283.64 Å, are from the former article and the others are from the latter. These wavelengths were employed by Bromage *et al.* (1978)²⁴ to obtain the $3s3p^4$ levels.

Fawcett⁷⁰ and Behring *et al.*⁴ identified the $3p^3-3p^23d$ transitions in the range 186–220 Å. Bromage *et al.*²⁴ made use of the wavelengths measured by Behring *et al.*⁴ to classify 17 lines.

Classifications of the $3p^3-3p^24s$, $3p^3-3p^24d$, $3p^33d-3p^34p$, and $3p^33d-3p^34f$ transitions were made by Fawcett *et al.* (1972)⁷² by observing them with a laboratory plasma. Their wavelengths in the range 65–111 Å were measured with an uncertainty of ± 0.01 Å.

Semi-empirical transition probabilities for M1 transitions within the ground configuration were calculated by Mendoza and Zeippen (1982)¹⁵⁶ and Biémont and Hansen (1985)¹⁰. Huang (1984)¹¹⁹ reported multiconfiguration Dirac-Fock calculations on transition probabilities not only for the $3s^23p^3-3s3p^4$ and $3p^3-3p^23d$ transitions but also for M1 transitions. Semi-empirical oscillator strengths for the $n=3-3$ and $3-4$ transitions were calculated by Fawcett (1986)⁸⁶. The tabulated oscillator strengths and transition probabilities for E1 and M1 transitions are taken from the critical data compilations of Fuhr *et al.* (1981)¹⁰⁷ and Kaufman and Sugar (1986)¹³⁵.

Fe XIII (Si-Sequence)

Ground state: $1s^22s^22p^63s^23p^2\ ^3P_0$

Wavelengths tabulated for M1 transitions within the $3p^2$ configuration are from the solar coronal observations of Jefferies *et al.* (1971)¹²⁵ above 3000 Å and of Sandlin *et al.* (1977)¹⁷² below 3000 Å. The $3p^2\ ^3P-^3P$ and $3p^2\ ^3P_2-^1D_2$ transitions were first identified by Edlén (1942)⁵⁶ and the $3p^2\ ^3P_1-^1S_0$ transition by Gabriel *et al.* (1971)¹¹¹.

The $3s^23p^2-3s3p^3$ and $3s^23p^2-3s^23p^33d$ transition arrays were observed in a laboratory plasma by Fawcett (1971)⁷⁰, who extended the analyses by Fawcett *et al.* (1967)⁶⁴ and Fawcett (1970)⁶⁸. Solar coronal observations were done by Widing *et al.* (1971)¹⁹⁵, Malinovsky and Heroux (1973)¹⁵², and Behring *et al.* (1976)⁴. The wavelength values with three decimal places in the 197–360 Å range are taken from Ref. 4, with the additional identifications by Bromage *et al.* (1978)²⁴. The line

at 227.479 Å classified as $3p^2\ ^1D_2-3p3d\ ^3P_2^\circ$ was not included in this compilation, because this wavelength is different by 0.68 Å from that calculated from the level values. Uncertainties in the wavelengths vary from ± 0.004 to ± 0.01 Å. The other wavelengths, given with two decimal places, are from the earlier measurements.

Fawcett *et al.* (1972)⁷² measured the $3p^2-3p4s$, $3p^2-3p4d$, $3p3d-3p4p$, and $3p3d-3p4f$ transitions in the range 62–108 Å with an uncertainty of ± 0.01 Å. They showed that the solar line classifications of the $3p^2\ ^3P-3p4s\ ^3P^\circ$ transition array by Zirin (1964)²⁰¹, Widing and Sandlin (1968)¹⁹⁴ and Behring *et al.* (1972)³ were incorrect. The $3p^2-3p4d$ and $3p3d-3p4f$ transitions were remeasured by Kastner *et al.* (1978)¹³⁴, from which the wavelengths of the $3p3d\ ^3D_2-3p4f\ ^3F_3$ at 82.010 Å, the $3p3d\ ^3P_0-3p4f\ ^3D_1$ at 81.154 Å, the $3p3d\ ^1P_1-3p4f\ ^1D_2$ at 85.461 Å, and the $3p^2-3p4d$ transitions are taken. It should be noted that the two lines at 82.010 and 81.154 Å are tentative identifications.

In a beam-foil spectrum, Träbert *et al.* (1988)¹⁸⁹ identified the intersystem lines $3s^23p^2\ ^3P_{1,2}-3s3p^3\ ^5S_2^\circ$ at 487.20 ± 0.4 Å and 510.37 ± 0.3 Å. One of these, the 487.08 ± 0.03 line Å, appears in the solar coronal spectrum of Dere (1978)⁴².

Semi-empirical transition probabilities for M1 lines in the ground configuration were calculated by Mendoza and Zeppen (1982)¹⁵⁷ and Biémont and Bromage (1983)⁹. Huang (1985)¹²⁰ reported multiconfiguration Dirac-Fock calculations of transition probabilities for the $3s^23p^2-3s3p^3$ and $3p^2-3p3d$ transitions, but also for the M1 transitions. Semi-empirical oscillator strengths for the $n=3-3$ transitions were calculated by Biémont (1986)¹¹ and Fawcett (1987)⁸⁷. The tabulated oscillator strengths and transition probabilities for E1 and M1 transitions are taken from the critical data compilations of Fuhr *et al.* (1981)¹⁰⁷ and Kaufman and Sugar (1986)¹³⁵.

Fe xiv (Al-Sequence)

Ground state: $1s^22s^22p^63s^23p^2\ ^2P_{1/2}^\circ$

Edlén (1942)⁵⁶ identified the solar coronal line at 5302.86 Å (in air) with the transition $3s^23p\ ^2P_{1/2}^\circ-^2P_{3/2}^\circ$. This line was also observed by Jefferies *et al.* (1971)¹²⁵.

The wavelengths of $3s^23p-3s3p^2$ transitions in the range 252–357 Å were measured in laser-produced plasmas by Fawcett and Peacock (1967)⁶⁵, Fawcett (1970)⁶⁸, and Fawcett (1971)⁷⁰. The $3s^23p\ ^2P^\circ-3s^23d\ ^2D$ line was first identified by Gabriel *et al.* (1966)¹¹⁰. Many solar coronal line identifications, including Jordan (1966)¹²⁷, were reported for these transitions, but their wavelengths are less accurate. The tabulated wavelengths are taken from the solar observations of Behring *et al.* (1976)⁴, with improved accuracies of ± 0.005 Å.

Fawcett⁶⁸ also classified two lines at 280.69 and 288.45 Å as the $3s3p^2\ ^4P_{3/2,5/2}-3p^3\ ^4S_{3/2}$ transitions.

The line at 218.21 Å was identified as the $3s3p^2\ ^4P_{5/2}-3s3p3d\ ^4D_{7/2}$ transition by Fawcett⁷⁰.

Classifications of the $n=3-4$ transitions were made in the range 58–92 Å by Edlén (1936)⁵³ for the $3p-4d$ array and by Fawcett *et al.* (1972)⁷² for the $3d-4p$, $3d-4f$, and $3s3p^2-3s3p4s$ arrays.

Spin-forbidden transitions $3s^23p\ ^2P^\circ-3s3p^2\ ^4P$ were observed by Träbert *et al.* (1988)¹⁸⁹ in a beam-foil spectrum. However, three of these, 444.25 ± 0.03 Å, 447.36 ± 0.03 Å, and 467.40 ± 0.03 Å, are taken from a more accurate solar measurement of Dere (1978)⁴².

Semi-empirical oscillator strengths for transitions within the $n=3$ shell were calculated by Fawcett (1983)⁷⁹. Huang (1986)¹²¹ reported the multiconfiguration Dirac-Fock calculations on transition probabilities not only for the arrays $3s^23p-3s3p^2$, $3s3p^2-3p^3$, $3s^23d-3s3p3d$, $3s^23p-3s^23d$, and $3s3p^2-3s3p3d$, but also for M1 transitions within the $3s^23p\ ^2P^\circ$ and $3s3p^2\ ^4P$ terms. Fischer (1986)¹⁰⁵ calculated the oscillator strengths and transition probabilities for E1 and M1 transitions between states in the $n=3$ shell and with $3s^24l\ ^2L$ terms using the multiconfiguration Hartree-Fock approach, with relativistic corrections included in the Breit-Pauli approximation. The tabulated oscillator strengths and transition probabilities for E1 and M1 transitions are taken from the critical data compilations of Fuhr *et al.* (1981)¹⁰⁷, Fuhr *et al.* (1988)¹⁰⁸, and Kaufman and Sugar (1986)¹³⁵.

Fe xv (Mg-Sequence)

Ground state: $1s^22s^22p^63s^2\ ^1S_0$

The line at 7058.6 Å (in air) was identified as the magnetic-dipole $^3P_1^\circ-^3P_2^\circ$ transition in the configuration $3s3p$ by Jefferies *et al.* (1971)¹²⁵.

Transitions among the configurations $3s^2$, $3s3p$, $3s3d$, $3p^2$, and $3p3d$ were identified in the region 198–537 Å in a laser produced spectrum by Churilov *et al.* (1985)³⁴, whose wavelengths and energy levels are adopted in the present compilation. Wavelengths were measured with an accuracy of ± 0.007 Å. Additional identifications, making the levels of $3p3d$ complete, were reported by Litzén and Redfors (1987)¹⁴⁸. Their wavelengths with an uncertainty of ± 0.02 Å and newly determined level values were included. The previous measurements of the 3–3 transitions by Peacock *et al.* (1965)¹⁶⁴, Fawcett (1970)⁶⁸, Fawcett (1971)⁷⁰, Fawcett (1972)⁷², Cowan and Widing (1973)⁴⁰, and Dere (1978)⁴² were revised and extended.

The wavelength of 417.258 ± 0.01 Å for the $3s^2\ ^1S_0-3s3p\ ^3P_1^\circ$ intercombination line is taken from Behring *et al.* (1976)⁴; the identification was made by Cowan and Widing⁴⁰. This line was also observed in tokamak plasmas by Finkenthal *et al.* (1982)¹⁰² and Peacock *et al.* (1984)¹⁶⁵.

Fawcett *et al.*⁷² classified the line $3s3p\ ^1P_1^\circ-3s4d\ ^1D_2$ at 59.404 Å, and the line $3s3d\ ^1D_2-3s4f\ ^1F_3$ at 71.029 Å. The latter transition was revised to 73.473 Å by Cowan and Widing⁴⁰. They also suggested identifications of the

transitions $3s3p\ ^1P_1^{\circ}-3s4s\ ^1S_0$ at 69.66 Å and $3p^2\ ^1D_2-3s4f\ ^1F_3^{\circ}$ at 63.96 Å.

Classification of the transition arrays $3p3d-3p4f$ was reported by Fawcett *et al.*⁷² and also by Kastner *et al.* (1978)¹³⁴. The tabulated wavelengths are from the latter article except for the $3p3d\ ^3F^{\circ}-3p4f\ ^3G$ lines, which are from the former. It should be noted that the line $^3F_3^{\circ}-^3F_4$ at 68.884 Å given as questionable by Kastner *et al.* has been excluded because it is inconsistent with the 3F_4 level obtained from the line at 71.062 Å.

The wavelengths of triplet arrays $3s3p\ ^3P^{\circ}-3s4s\ ^3S$ and $3s3p\ ^3P^{\circ}-3s5d\ ^3D$ were measured in the range of ~ 65 Å and ~ 41 Å by Feldman *et al.* (1971)⁹⁴. Their wavelengths are accurate to ± 0.01 Å.

Edlén (1936)⁵³ identified the transitions $3s^2\ ^1S_0-3s4p\ ^1P_1^{\circ}$, $3s3p\ ^3P^{\circ}-3s4d\ ^3D$, and $3s3d\ ^3D-3snf\ ^3F^{\circ}$ ($n=4, 5$) in the 50–70 Å range. Identifications along Rydberg series were subsequently added by Fawcett *et al.* (1966)⁸³ for the $3s^2\ ^1S_0-3s5p\ ^1P_1^{\circ}$, $3s3p\ ^3P_2^{\circ}-3s5s\ ^3S_1$, $3s3d\ ^3D_3-3s6f\ ^3F_4^{\circ}$, and $3s3d\ ^1D_2-3snf\ ^1F_3^{\circ}$ ($n=5, 6$) transitions.

The $2p^63s3p-2p^53s^23p$ transitions were tentatively identified by Burkhalter *et al.* (1979)³⁰ who measured the wavelengths in the ~ 17 Å range with an uncertainty of ± 0.01 Å.

Semi-empirical oscillator strengths were calculated by Fawcett (1983)⁸⁰ for the E1 $n=3-3$ transitions and extended by Fawcett (1986)⁸³ to the 3–4 transitions. Tayal (1986)¹⁸⁷ calculated oscillator strengths for E1 transitions among the $3s^2\ ^1S$, $3s3p\ ^1,^3P^{\circ}$, $3p^2\ ^3P, ^1D, ^1S$, and $3s3d\ ^1,^3D$ terms. Transition probabilities for the $n=3-3$ transitions were reported by Bhatia and Kastner (1980)⁶. The tabulated oscillator strengths and transition probabilities for E1 and M1 transitions are taken from the critical data compilations of Fuhr *et al.* (1981)¹⁰⁷, Fuhr *et al.* (1988)¹⁰⁸, and Kaufman and Sugar (1986)¹³⁵.

Fe xvi (Na-Sequence)

Ground state: $1s^22s^22p^63s\ ^2S_{1/2}$

The $3s-3p$ and $3p-3d$ lines in the region 250–360 Å were classified in a laboratory plasma by Peacock *et al.* (1965)¹⁶⁴. Many wavelength measurements of these lines were reported in solar coronal and laboratory plasma observations, including those of Peacock *et al.* (1984)¹⁶⁵, Feldman *et al.* (1971)⁹⁴, and Behring *et al.* (1976)⁴.

An isoelectronic comparison of the measured wavelengths, including the $3d-4f$ doublet, with Dirac-Fock calculations was made by Reader *et al.* (1987)¹⁶⁹ for Ar^{7+} to Xe^{43+} , and least squares adjusted wavelength values were derived from the differences between theory and experiment. The overall uncertainty estimate is ± 0.007 Å. We give these results.

Edlén (1936)⁵² identified the transitions $3s-4p$, $3p-4s$, $3p-nd$, and $3d-nf$ ($n=4, 5$) in the range 39–67 Å. Except for the $3d-4f$, Edlén's wavelengths are adopted in this compilation.

The $4d\ ^2D-5f\ ^2F^{\circ}$ transitions were identified by Lawson and Peacock (1980)¹⁴⁶, who also assigned the lines at 156.80 Å and 156.88 Å to the $4f\ ^2F^{\circ}-5g\ ^2G$ array.

Transitions between highly excited levels ($5 < n < 9$) and the $n=3$ levels were observed by Fawcett *et al.* (1966)⁶³ and Feldman *et al.* (1971)⁹⁴ with uncertainties of ± 0.03 Å and ± 0.01 Å.

The lines due to the $2p^631-2p^53s31$ transitions in the range 16–18 Å were observed with an uncertainty of ± 0.01 Å by Burkhalter *et al.* (1979)³⁰.

Oscillator strengths and transition probabilities are taken from the critical data compilation of Fuhr *et al.* (1981)¹⁰⁷.

Fe xvii (Ne-Sequence)

Ground state: $1s^22s^22p^6\ ^1S_0$

Jupén (1984)¹³⁰ ascribed 19 lines in solar flare spectra in the region 204–410 Å observed by Dere (1978)⁴² to transitions among the $2p^53s$, $2p^53p$, and $2p^53d$ configurations on the basis of an isoelectronic extrapolations. Some of Jupén's identifications were revised by Feldman *et al.* (1985)¹⁰¹ using their own observations. From these they identified a wide line at 1153.20 Å as the $2p^53s\ ^3P_1^{\circ}-^3P_0^{\circ}$ magnetic-dipole (M1) transition. The uncertainty in the wavelengths is estimated as ± 0.03 Å. A new study of this spectrum by Buchet *et al.* (1987)²⁸ using a beam-foil light source confirms most of the identifications of Jupén and the corrections suggested by Feldman *et al.* However, Buchet *et al.* identify a line at 296.3 Å as the $2p^53s\ ^3P_1^{\circ}-2p^53p\ ^3P_0^{\circ}$ transition, whereas Feldman *et al.* identify it as the line at 295.98 Å. A second disagreement occurs for the transition $2p^53s\ ^3P_0^{\circ}-2p^53p\ ^1P_1$, for which Feldman *et al.* report 373.41 Å and Buchet *et al.* give 372.93 Å. The identifications of Feldman *et al.* do not fit into the level scheme of Buchet *et al.* Because of the generally greater certainty of identifications of wavelengths achieved in laboratory work compared with solar data, we give the results of Buchet *et al.* For the line at 269.6 Å, classified both as the $2p^53p\ ^3D_2-2p^53d\ ^3F_3^{\circ}$ and $2p^53p\ ^3S_1-2p^53d\ ^3P_0^{\circ}$ transitions, we adopted Dere's wavelengths, 269.42 and 269.88 Å, classified by Jupén. The solar line at 1153.20 Å classified as an M1 transition by Feldman *et al.*, is inconsistent with the data of Buchet *et al.*

The $2s^22p^53s-2s2p^63s$ transitions were identified in a tokamak plasma by Finkenthal *et al.* (1985)¹⁰⁴. Three lines due to the $^3P_{2,1,0}^{\circ}-^3S_1$ transitions at 89.77, 90.77 and 98.38 Å are excluded because they give a fine structure splitting for the $^3P^{\circ}$ term that is inconsistent with the present compilation.

The identifications of $2p^53p-2p^54d$ transitions were reported by Kastner *et al.* (1975)¹³². From a laser-produced plasma Fawcett *et al.* (1979)⁷⁷ identified the $2p^53p-2p^54s$, $2p^53p-2p^54d$, $2p^53d-2p^54f$, and $2p^53d-2p^55f$ lines in the range of 41–60 Å. Level desig-

nations of $3p$ and $4d$ are given in jK and LS coupling schemes in Ref. 132.

Wavelengths below 18 Å corresponding to transitions from the levels $2p^5 3s$, $4s$, $2s 2p^6 4s$, $2s 2p^6 3p$, $4p$, and $2p^5 3d$, $4d$, $5d$, $6d$ to the ground level were measured in a laser-produced plasma by Gordon *et al.* (1980)¹¹² with an uncertainty of ± 0.005 Å. These include the lines measured previously by Tyrén (1938)¹⁹¹ and Hutcheon *et al.* (1976)¹²³. From Ref. 123, we selected only the $2p^6 - 2p^5(^2P_{3/2})3s(^3/2, 1/2)_2^o$ transition at 17.097 Å, which was not given in Ref. 112. Transitions along Rydberg series were identified in solar observations with an uncertainty of ± 0.003 Å by Hutcheon *et al.* (1976)¹²², from which 7 lines corresponding to the transitions from the $2p^5 5s$, $6s$, $7s$, $2s 2p^6 5p$, and $2p^5 7d$, $8d$ levels to the ground level were taken.

Oscillator strengths and transition probabilities are taken from the critical data compilations of Fuhr *et al.* (1981)¹⁰⁷ and Fuhr *et al.* (1988)¹⁰⁸.

Fe XVIII (F-Sequence)

Ground state: $1s^2 2s^2 2p^5 \ ^2P_{3/2}^o$

The $2s^2 2p^5 \ ^2P_{3/2}^o - ^2P_{1/2}^o$ magnetic-dipole line was observed in solar coronal spectra by Doschek *et al.* (1975)⁴⁸ and Sandlin *et al.* (1977)¹⁷² and also in tokamak discharges by Suckewer and Hinnov (1979)¹⁸¹, Hinnov and Suckewer (1980)¹¹⁶, Hinnov *et al.* (1982)¹¹⁷, Finkenthal *et al.* (1984)¹⁰³, and Peacock *et al.* (1984)¹⁶⁵. The most accurate wavelength of 974.86 ± 0.02 Å is from the last article.

The lines at 93.923 ± 0.004 and 103.937 ± 0.004 Å of the $2s^2 2p^5 \ ^2P^o - 2s 2p^6 \ ^2S$ doublet are given by Kovalev *et al.* (1983)¹⁴³. Peacock *et al.* (1984)¹⁶⁵ obtained the wavelengths of 93.929 ± 0.003 Å and 103.941 ± 0.004 Å for these transitions, respectively. The arithmetic mean values are given in this compilation.

Phillips *et al.* (1982)¹⁶⁶ provided identifications of the $2s 2p^6 \ ^2S - 2s 2p^5(^3P^o)3s \ ^4P^o$ lines, including the $^2S_{1/2} - ^4P_{5/2}^o$ a magnetic-quadrupole transition at 16.337 Å and the $2s 2p^6 \ ^2S_{1/2} - 2s 2p^5(^3P^o)3s \ ^2P_{3/2}^o$ transition at 16.165 Å, from solar coronal observations.

Following the classifications of $2p^5 - 2p^4 3s$ and $2p^5 - 2p^4 3d$ transitions by Fawcett *et al.* (1967)⁶⁴, many measurements for these transitions have been reported. The tabulated wavelengths in the 10–16 Å range are from Gordon *et al.* (1980)¹¹², who revised and extended the work of Feldman *et al.* (1973)⁹⁵. The uncertainties of the wavelengths are ± 0.005 Å in Ref. 112 and ± 0.01 Å in Ref. 95. The $2p^5 \ ^2P_{3/2}^o - 2p^4(^3P)3d \ ^2D_{5/3}$ and $2p^5 \ ^2P_{1/2}^o - 2p^4(^1D)3d \ ^2D_{3/2}$ transitions at 14.373 Å and 14.361 Å are taken from Feldman *et al.*⁷⁴. Four additional lines from Ref. 95 are included in this compilation.

Gordon *et al.*¹¹² identified the $2s^2 2p^5 - 2s 2p^5 3p$, $2p^4 4d$, and $2p^4 4s$ transition arrays in the range 11–14 Å. An additional line at 11.442 Å was identified as the $2p^5$

$^2P_{3/2}^o - 2p^4(^3P_1)4d(1, ^5/2)_{3/2}$ transition by Boiko *et al.* (1978)¹⁶.

The wavelengths of $2p^5 - 2p^4 5d$ and $2p^4 6d$ transitions were measured by Burkhalter *et al.* (1978)²⁹.

The line $1s 2s^2 2p^6 \ ^2S_{1/2} - 2s^2 2p^5 \ ^2P_{3/2}^o$ at 1.92164 Å is from the solar flare observations by Seely *et al.* (1986)¹⁷⁵, with an uncertainty of ± 0.02 mÅ.

Transition probabilities for the $n=2-2$ transitions and semi-empirical oscillator strengths for the $n=2-2$ and $2-3$ transitions were calculated by Feldman *et al.* (1980)⁹⁹ and by Fawcett (1984)⁸², respectively. The tabulated oscillator strengths and transition probabilities for E1 and M1 transitions are taken from the critical data compilations of Fuhr *et al.* (1981)¹⁰⁷ and Kaufman and Sugar (1986)¹³⁵.

Fe XIX (O-Sequence)

Ground state: $1s^2 2s^2 2p^4 \ ^3P_2$

Three M1 lines within the ground configuration were observed in solar flares. The $^3P_2 - ^3P_1$ line at 1118.1 Å was identified by Doschek (1975)⁴⁸. The other two M1 lines at 592.16 Å and 424.26 Å were ascribed to the $^3P_2 - ^1D_2$ and $^3P_1 - ^1S_0$ transitions by Widing (1978)¹⁹⁹. These lines, except for the $^3P_1 - ^1S_0$ line, were also observed in tokamak discharges by Suckewer and Hinnov (1979)¹⁸¹, Hinnov *et al.* (1982)¹¹⁷, Finkenthal *et al.* (1984)¹⁰³, and Peacock *et al.* (1984)¹⁶⁵. The wavelengths 1118.060 ± 0.010 Å for $^3P_2 - ^3P_1$ and 592.234 ± 0.006 Å for $^3P_2 - ^1D_2$ were obtained in the last work.

Comparing the prediction by Edlén (1981)⁵⁸ with the previous measurements for the $2s^2 2p^4 - 2s 2p^5$ and $2s 2p^5 - 2p^6$ arrays in the range from 91 to 120 Å, Kononov (1983)¹⁴² found that there appeared wavelength deviations of up to 0.03 Å in the measurements, except those of Kovalev *et al.* (1983)¹⁴³. Tabulated are the wavelengths from Kovalev *et al.*¹⁴³, the uncertainty of which is ± 0.004 Å. Kovalev *et al.*¹⁴³ and Lawson and Peacock (1980)¹⁴⁶ provided additional intercombination lines due to the $2s^2 2p^4 \ ^3P_{0,1,2} - 2s 2p^5 \ ^1P^o$, $2s^2 2p^4 \ ^1D_2 - 2s 2p^5 \ ^3P_2^o$, and the $2s 2p^5 \ ^3P_1^o - 2p^6 \ ^1S_0$ transitions, respectively.

Fawcett *et al.* (1974)⁷³ and Fawcett and Hayes (1975)⁷⁶ proposed classifications of the $2p^4 - 2p^3 3d$ transitions, using the wavelengths measured by Cohen and Feldman (1970)³⁶, Swartz *et al.* (1971)¹⁸⁵, and Neupert *et al.* (1973)¹⁶¹. An analysis of the transition arrays $2p^4 - 2p^3 3s$, $2p^3 3d$, and $2p^3 4d$ was made by Gordon *et al.* (1980)¹¹². Their observations, with a laser-produced plasma, were in the wavelength range of 10–15.2 Å. The tabulated wavelengths are from Ref. 112, but omitting the two transitions $2s^2 2p^4 \ ^1D_2 - ^3P_1 - 2s^2 2p^3(^2P^o)4d \ ^3D_2^o$ at 10.644 Å and 10.543 Å. The upper levels calculated with these lines are inconsistent. The uncertainty of the wavelengths is estimated to be ± 0.005 Å. Solar coronal observations of the first two arrays were reported by Pye *et*

al. (1977)¹⁶⁷, McKenzie *et al.* (1980)¹⁵⁴ and Phillips *et al.* (1982)¹⁶⁶. The *jj* and *LS* percentage compositions are available from Gordon *et al.*¹¹²

The $2p^4-2p^35d$ and $2p^36d$ transitions were identified between 9 and 10 Å by Burkhalter *et al.* (1978)²⁹.

The inner-shell $1s^22s^22p^4-1s2s^22p^5$ transition at 1.91765 ± 0.00002 Å was identified in a solar flare spectrum by Seely *et al.* (1986)¹⁷⁵.

Transition probabilities for the $n=2-2$ transitions and the semi-empirical oscillator strengths for the $n=2-2$ and $2-3$ transitions were calculated by Feldman *et al.* (1980)⁹⁹ and by Fawcett (1986)⁸⁴, respectively. The tabulated oscillator strengths and transition probabilities for E1 and M1 transitions are taken from the critical data compilations of Fuhr *et al.* (1981)¹⁰⁷ and Kaufman and Sugar (1986)¹³⁵.

Fe xx (N-Sequence)

Ground state: $1s^22s^22p^3\ ^4S_{3/2}^o$

The $2s^22p^3\ ^2D_{3/2}^o-^2D_{5/2}^o$ line at 2665.1 ± 0.3 Å (in air) was observed in a tokamak discharge by Suckewer and Hinnov (1978, 1979)^{180,181} and subsequently by Hinnov *et al.* (1982)¹¹⁷. Another M1 transition, $2s^22p^3\ ^2D_{3/2}^o-^2P_{3/2}^o$ at 541.35 ± 0.03 Å, was identified in a solar flare by Widing (1978)¹⁹⁹. This line was also observed in a tokamak plasma by Finkenthal *et al.* (1984)¹⁰³. The wavelengths of 309.26 and 567.76 Å measured by Sandlin *et al.* (1976)¹⁷¹ and Widing (1978)¹⁹⁹, respectively, were assigned to the intercombination transitions $2s^22p^3\ ^4S_{3/2}^o-^2P_{3/2}^o$, $^2D_{5/2}^o$ by Lawson *et al.* (1981)¹⁴⁷. Edlén (1982)⁵⁹ confirmed these assignments on the basis of an accurate prediction of the energy intervals along the nitrogen sequence. The wavelength value of 679.3 Å, corresponding to the $2s^22p^3\ ^2D_{5/2}^o-^2P_{3/2}^o$ magnetic dipole transition, is from Edlén's prediction.

Lines of the $2s^22p^3-2s2p^4$ array in the 90–133 Å range were identified by Doschek *et al.* (1974)⁴⁵ and also by Feldman *et al.* (1975)⁹⁷ utilizing laser-produced plasmas. Kononov *et al.* (1976)¹³⁸ identified the $2s2p^4-2p^5$ array, in the wavelength range 98–141 Å, from a laser-produced plasma. An extensive analysis of these arrays in the range 80–141 Å with an uncertainty of ± 0.03 Å was made by Lawson and Peacock (1980)¹⁴⁶, who proposed 20 line identifications for the $2s^22p^3-2s2p^4$ array and 10 for the $2s2p^4-2p^5$ array including intercombination lines. Wavelengths, with an uncertainty of ± 0.004 Å, are taken from Kovalev *et al.* (1983)¹⁴³. The $2s^22p^3\ ^4S_{3/2}^o-2s2p^4P_{5/2}$ transition at 132.850 ± 0.06 Å is from Peacock *et al.* (1984)¹⁶⁵.

Measurements in the range of 8–14 Å with an accuracy of ± 0.005 Å were made by Bromage *et al.* (1977)²⁰ with a laser-produced plasma. They identified the $2p^3-2p^23d$, $2p^24d$, and $2p^25d$ transitions.

The transitions between the ground configuration and $1s2s^22p^4$ were identified in a laboratory plasma by Lie and Elton (1971)¹⁴⁸ and in solar flare observations by Feldman *et al.* (1980)¹⁰⁰ and Seely *et al.* (1986)¹⁷⁵. The two lines $^4S_{3/2}^o-^4P_{3/2,5/2}$ at 1.90568 and 1.90845 Å are from Ref. 175 with an uncertainty estimate of 0.02 mÅ and the others are from Ref. 100 with an uncertainty estimate of 0.5 mÅ.

The transition probabilities for the $n=2-2$ transitions were calculated by Feldman *et al.* (1980)⁹⁹. The tabulated oscillator strengths and transition probabilities for E1 and M1 transitions are taken from the critical data compilations of Fuhr *et al.* (1981)¹⁰⁷ and Kaufman and Sugar (1986)¹³⁵.

Fe XXI (C-Sequence)

Ground state: $1s^22s^22p^2\ ^3P_0$

The M1 transition within the ground configuration, $^3P_0-^3P_1$, was first identified at 1354.1 ± 0.1 Å in solar flares by Doschek *et al.* (1975)⁴⁸. Sandlin *et al.* (1977)¹⁷² assigned a more accurate wavelength of 1354.08 ± 0.05 Å to this transition. Three additional lines due to the $^3P_1-^3P_2$, $^3P_{1,2}-^1D_2$ transitions were observed at 2298.0 Å (in air), 786.1 Å, and 585.8 Å with an uncertainty estimate of ± 0.3 Å by Hinnov *et al.* (1982)¹¹⁷. The $^3P_0-^3P_1$ and $^3P_1-^1D_2$ lines were also found in a tokamak plasma spectrum by Finkenthal *et al.* (1984)¹⁰³.

The $2s^22p^2\ ^3P_{2,1}-2s2p^3\ ^5S_2^o$ lines at 270.52 and 242.07 Å were identified in solar coronal spectra by Dere (1978)⁴². The wavelength accuracy is ± 0.03 Å. The other $2s^22p^2-2s2p^3$ and $2s2p^3-2p^4$ transitions, including intercombination transitions, were classified by Lawson and Peacock (1980)¹⁴⁶ in an analysis of a laser-produced spectrum in the range 84–182 Å. The uncertainty of the wavelengths is ± 0.03 Å. The earlier works of Kastner *et al.* (1974)¹³¹, Feldman *et al.* (1975)⁹⁷, and Kononov *et al.* (1976)¹³⁸ were revised and extended.

Fawcett *et al.* (1974)⁷³ identified a solar flare line at 12.38 Å observed by Neupert *et al.* (1973)¹⁶¹ as due to the $2p^2\ ^3P_2-2p3d\ ^3D_3^o$ transition. Bromage and Fawcett (1977)²² revised the earlier tentative identifications of the $2p^2-2p3d$ array by Fawcett and Hayes (1975)⁷⁶ using lines observed by Boiko *et al.* in 1976 with a laser-produced plasma. The wavelengths were published by Boiko *et al.* (1978)¹⁶. We have tabulated the 6 lines identified in Ref. 22 and the line at 12.38 Å. The other classifications in Ref. 16 are tentative. The uncertainty of the wavelengths is ± 0.003 Å. The $2p^2\ ^3P_{0,1}-2p3d\ ^3D_1^o$ transitions were identified with solar flare lines by McKenzie *et al.* (1980)¹⁵⁴ and Phillips *et al.* (1982)¹⁶⁶, at the wavelengths 12.285 Å and 12.398 ± 0.002 Å.

Classifications of the $2p^2-2p4d$, $2p5d$ transitions were reported by Bromage *et al.* (1977)²⁰, who analyzed the laser-produced plasma spectrum of Boiko *et al.* in the range 8.5–9.6 Å. The wavelength uncertainty is

± 0.002 Å. Fawcett *et al.* (1987)⁹⁰ identified 3 lines at 9.632 Å, 9.476 Å, and 8.573 Å in a solar flare as resonance transitions from the $2p4s$ $^3P_1^o$, $2p4d$ $^3D_1^o$ and $2p5d$ $^3D_1^o$ levels to the ground level. In addition, they provided more accurate wavelengths for the $2p^2$ $^3P_2-2p4d$ $^3F_3^o$ transition and $2p^2$ $^3P-2p4d$ $^3D^o$ array.

The wavelengths due to the $1s^22s^22p^2-1s2s^22p^3$ inner-shell transitions are from solar flare observations by Feldman *et al.* (1980)¹⁰⁰ and Seely *et al.* (1986)¹⁷⁵ with estimated wavelength uncertainties of ± 0.5 mÅ and ± 0.15 mÅ, respectively.

Transition probabilities were calculated by Feldman *et al.* (1980)⁹⁹ for the $n=2-2$ transitions and by Bhatia *et al.* (1987)⁸ for the $n=2-3$ transitions. Semi-empirical oscillator strengths for the $n=2-2$ and $n=2-3$ transitions were calculated by Fawcett (1987)⁸⁹. The tabulated oscillator strengths and transition probabilities for E1 and M1 transitions are taken from the critical data compilations of Fuhr *et al.* (1981)¹⁰⁷ and Kaufman and Sugar (1986)¹³⁵.

Fe xxii (B-Sequence)

Ground state: $1s^22s^22p^2$ $^2P_{1/2}^o$

The M1 transition $2s^22p^2$ $^2P_{1/2}^o-2p^3$ $^2P_{3/2}^o$ was first identified in solar flares by Doschek *et al.* (1975)⁴⁸ and subsequently in a tokamak discharge by Suckewer and Hinnov (1979)¹⁸¹, whose wavelength, 845.5 ± 0.1 Å, is adopted here. This line was also observed in tokamak discharges by Hinnov and Suckewer (1980)¹¹⁶, Hinnov *et al.* (1982)¹¹⁷, and Finkenthal *et al.* (1984)¹⁰³.

Sandlin *et al.* (1976)¹⁷¹ tentatively identified 4 intercombination lines corresponding to the $2s^22p^2$ $^2P^o-2s2p^2$ 4P array in the solar corona.

Wavelengths in the range 100–174 Å in a laser-produced plasma were assigned to the $2s^22p-2s2p^2$ and $2s2p^2-2p^3$ transitions by Lawson and Peacock (1980)¹⁴⁶. The uncertainty of the wavelengths is estimated to be ± 0.03 Å. The earlier classifications by Fawcett and Cowan (1975)⁷⁵, Doschek *et al.* (1975)⁴⁶, and Kononov *et al.* (1976)¹³⁸ were revised and extended.

The transition arrays $2s^22p-2s^23d$, $2s^22p-2s2p3p$, $2s2p^2-2s2p3d$, $2s^22p-2s^24d$, and $2s2p^2-2s2p4d$ were identified by Bromage *et al.* (1978)²⁵, who used the lines in the range 8.9–12.1 Å measured by Boiko *et al.* (1978)¹⁶ with a laser-produced plasma. The uncertainty of the wavelengths is ± 0.003 Å. We adopted their identifications, except for the $2s^22p-2s^24d$ array. To this array and also the $2s^22p-2s2p4p$ and $2s^22p-2s^25d$ transitions, Fawcett *et al.* (1987)⁹⁰ assigned wavelengths of solar flare lines with an uncertainty of ± 0.3 mÅ. A very weak line at 11.935 ± 0.002 Å in a solar flare spectrum was identified as the $2s^22p$ $^2P_{3/2}^o-2s^23d$ $^2D_{3/2}$ transition by Phillips *et al.* (1982)¹⁶⁶.

The $2p$ $^2P^o-4s$ 2S lines at 9.06 Å and 9.14 ± 0.03 Å were observed with a exploded wire by Burkhalter *et al.* (1978)²⁹.

Wavelengths at ~ 1.88 Å due to the inner shell transitions $1s^22s^22p-1s2s^22p^2$ are taken from the solar flare measurements by Feldman *et al.* (1980)¹⁰⁰ and Seely *et al.* (1986)¹⁷⁵. The wavelength uncertainties are ± 0.5 mÅ for the $^2P_{1/2}^o-2P_{1/2}$, $^2P_{3/2}^o-2P_{1/2,3/2}$, and $^2P_{3/2}^o-2S_{1/2}$ transitions, and ± 0.10 mÅ for the $^2P_{1/2}^o-2D_{3/2}$ and $^2P_{3/2}^o-2D_{5/3}$ transitions.

Transition probabilities were calculated by Feldman *et al.* (1980)⁹⁹ for the $n=2-2$ transitions and Bhatia *et al.* (1986)⁷ for the $n=2-3$ transitions. The tabulated oscillator strengths and transition probabilities for E1 and M1 transitions are taken from the critical data compilations of Fuhr *et al.* (1981)¹⁰⁷ and Kaufman and Sugar (1986)¹³⁵.

Fe xxiii (Be-Sequence)

Ground state: $1s^22s^2$ 1S_0

The M1 transition $2s2p$ $^3P_1^o-3P_2^o$ was observed in tokamak discharges by Hinnov *et al.* (1982)¹¹⁷ and Finkenthal *et al.* (1984)¹⁰³. The wavelength 1079.3 ± 0.3 Å was given in Ref. 117.

Two solar flare lines at 132.83 Å and 263.76 Å were identified as the $2s^2$ $^1S_0-2s2p$ $^1P_1^o$ and $^3P_1^o$ transitions by Kastner *et al.* (1974)¹³¹ and Widing (1975)¹⁹⁷, respectively. In Ref. 197, both of the lines were measured with an uncertainty of ± 0.03 Å. These lines were also observed by Sandlin *et al.* (1976)¹⁷¹, Hinnov *et al.* (1979)¹¹⁵, and Lawson and Peacock (1980)¹⁴⁶.

Wavelengths in the range 136–222 Å, measured with a laser produced plasma, were assigned to the $2s2p-2p^2$ array by Lawson and Peacock¹⁴⁶. The uncertainty of the wavelengths is ± 0.03 Å. Edlén (1985)⁶⁰ has confirmed their identifications for the $2s2p$ $^1P_1^o$ and $^3P_2^o-2p^2$ 1D_2 lines at 221.33 ± 0.06 Å and 136.53 ± 0.03 Å.

A comprehensive analysis was made by Bromage *et al.* (1978)²⁵ of the transition arrays $2s^2-2snp$, $2s2p-2snd$, $2s2p-2pnp$, and $2p^2-2pnd$ ($n=3-5$). They used wavelengths of Boiko *et al.* (1978)¹⁶ with an uncertainty of ± 0.003 Å in the range of 7.4–11.9 Å, which are tabulated with additions and substitutions stated below.

The arrays with $n=3$, including many weak lines, were previously identified by Boiko *et al.* (1977)¹⁵. The wavelengths of $2p^2-2p3s$ and $2s2p-2s3s$ transitions are from Ref. 15.

The $2s2p$ $^3P_1^o-2p4p$ 3D_2 line at 8.289 ± 0.006 Å was given by Fawcett *et al.* (1979)⁷⁸. A solar flare spectrum was measured with an uncertainty of ± 0.0003 Å by Fawcett *et al.* (1987)⁹⁰, from which 6 wavelengths are taken for the $2s^2-2s4p$, $2s2p-2s4d$, and $2s2p-2s4s$ transition arrays, including the $2s^2$ $^1S_0-2s4p$ $^3P_1^o$ intercombination line at 8.317 Å.

The $1s^2 2s^2 - 1s 2s^2 2p$ and $1s^2 2s 2p - 1s 2s 2p^2$ transitions at ~ 1.8 Å were identified by Seely *et al.* (1986)¹⁷⁵ and Kononov *et al.* (1977)¹⁴⁰ in a vacuum spark discharge spectrum. Their wavelength uncertainties are ± 0.3 mÅ.

Semi-empirical oscillator strengths were published by Fawcett (1984)⁸¹ for the $n=2-3$ transitions. The tabulated oscillator strengths and transition probabilities are taken from the critical data compilations of Fuhr *et al.* (1981)¹⁰⁷ and Fuhr *et al.* (1988)¹⁰⁸.

Fe xxiv (Li-Sequence)

Ground state: $1s^2 2s^2 S_{1/2}$

The $2s^2 S - 2p^2 P$ doublet was observed in solar flares and identified by Widing and Purcell (1976)¹⁹⁸ and Sandlin *et al.* (1976)¹⁷¹. These transitions were also observed in a tokamak discharge by Hinnov (1979)¹¹⁵. The $2s^2 S_{1/2} - 2p^2 P_{3/2}$ and $2s^2 S_{1/2} - 2p^2 P_{1/2}$ lines at 192.04 Å and 255.10 Å ± 0.02 Å are from Ref. 198.

The $2s - np$ ($n=3-5$), $2p - 3s$, and $2p - nd$ ($n=3-6$) transitions were identified by Neupert *et al.* (1973)¹⁶¹ and also by Fawcett *et al.* (1974)⁷³ for $n=3$. These identifications were extended by Boiko *et al.* (1978)¹⁶ to np ($n=3-5, 7$), ns ($n=3, 4$), and nd ($n=3-6$) with wavelengths in the range 6.5–11.5 Å. They measured the wavelengths with an estimated uncertainty of ± 0.003 Å. We have tabulated the wavelengths identified in Ref. 16 except for three transitions: $2p^2 P_{1/2} - 4s^2 S_{1/2}$ at 8.2854 Å, $2p^2 P_{3/2} - 4d^2 D_{5/3}$ at 8.3160 Å, $2p^2 P_{3/2} - 4s^2 S_{1/2}$ at 8.2854 Å, and the $2s - 4p$ and $2p - 4d$ transitions. These were accurately measured by Seely and Feldman (1986)¹⁷⁴ and Fawcett *et al.* (1987)⁹⁰ in solar flares with uncertainties of ± 0.0007 Å and ± 0.0003 Å, respectively.

The inner shell transitions $1s^2 2s - 1s 2s 2p$ and $1s^2 2p - 1s 2p^2$ were identified by Grineva *et al.* (1973)¹¹³, Feldman *et al.* (1980)¹⁰⁰, Seely and Feldman (1985)¹⁷³, and Seely *et al.* (1986)¹⁷⁵ in solar flares. They were also observed by Kononov *et al.* (1977)¹⁴⁰ with a vacuum spark discharge, and by Bitter *et al.* (1979)¹² with a tokamak discharge. Wavelengths are taken from Refs. 113, 140, 173 and 175. The uncertainty of the wavelengths is estimated to be between ± 0.04 mÅ and 0.4 mÅ. The $1s^2 3s - 1s 2p 3s$, $1s^2 3p - 1s 2p 3p$, and $1s^2 3d - 1s 2p 3d$ transitions in the region of 1.85 Å were provided in Refs. 139 and 173, as well. The $1s - 3p$ transitions at 1.5960 Å, 1.5926 Å, 1.588 Å were identified with a vacuum spark discharge by Klapisch *et al.* (1977)¹³⁶. Since they are identified as a blend of many transitions, we could not give classifications for them.

Oscillator strengths and transition probabilities are taken from the critical data compilations of Fuhr *et al.* (1981)¹⁰⁷.

Fe xxv (He-Sequence)

Ground state: $1s^2 S_0$

Calculated energy levels of the configurations $1snl$ with $l=s, p$, and d have been taken from Drake (1985)⁵⁰ for $n=2-3$. For the levels with $n=4-5$, calculations of Vainshtein and Safronova (1985)¹⁹² have been tabulated after adjusting them by 1410 cm^{-1} to the ground state binding energy obtained by Drake. This value is the arithmetic mean value of the differences between the levels given in the above two articles for $3s$, $3p$, and $3d$. Wavelengths are calculated from the energy levels by the Ritz combination principle.

The more accurate measured wavelengths of this spectrum are given below.

The $1s^2 S_0 - 1s 2p^1 P_1^o$, $3P_2^o$, and $3P_1^o$ and $1s^2 S_0 - 1s 2s^3 S_1$ lines were found at 1.85048 Å, 1.85555 Å, 1.85960 Å, and 1.86830 Å, respectively, in a tokamak discharge by Beiersdorfer *et al.* (1986)⁵. The first wavelength cited above was a theoretical value and the rest are normalized to it.

The $1s^2 S_0 - 1s 3p^1 P_1^o$ and $3P_1^o$ transitions were identified by Klapisch *et al.* (1977)¹³⁶ at 1.5738 and 1.5755 Å in a spark discharge. The $1s^2 S_0 - 1s np^1 P_1^o$ ($n=4-6$) lines at 1.4948, 1.4605, and 1.4433 ± 0.0006 Å were measured by Morita and Fujita (1983)¹⁵⁹ in a similar discharge. No uncertainty is assigned in the first paper, but in the second the given uncertainty indicates agreement of these results with Drake's values.

The $1s 2s^3 S_1 - 1s 2p^3 P_2^o$ line at 271.02 ± 0.09 Å was observed by Buchet *et al.* (1981)²⁶ in a beam foil experiment. It deviates from Drake's value by twice its uncertainty.

The multiplet $1s 2p^3 P^o - 1s 3d^3 D$ and the transitions $1s 2p^1 P_1^o - 1s nd^1 D_2$ ($n=3, 4$) were classified by Burkhalter *et al.* (1978)²⁹ as being lines at 10.19, 10.33, 10.41, and 7.75 Å in an exploding wire spectrum.

The $1s 2p^1 P_1^o - 2p^2 S_0$ and $1D_2$ and $1s 2s^3 S_1 - 2s 2p^3 P_2^o$ transitions at ~ 1.79 Å were identified by Turechek and Kunze (1975)¹⁹⁰ in a spark discharge. The uncertainty in the wavelengths is ± 0.1 mÅ.

Oscillator strengths and transition probabilities are taken from the critical data compilations of Fuhr *et al.* (1981)¹⁰⁷.

Fe xxvi (H-Sequence)

Ground state: $1s^2 S_{1/2}$

The $1s^2 S_{1/2} - 2p^2 P_{1/2, 3/2}^o$ transitions were observed by Turechek and Kunze (1975)¹⁹⁰, Morita and Fujita (1983)¹⁵⁹, and Beiersdorfer *et al.* (1986)⁵. We have tabulated the wavelengths calculated from the theoretical level energies by Johnson and Soff (1985)¹²⁶ for the $n=2$ shell, which are in close agreement with those by Mohr (1983)¹⁵⁸. All levels with $n=3-5$ are available from the

work of Erickson (1977)⁶¹. For the *ns* and *np* ($n=3-5$) levels, Erickson's values for the binding energies were subtracted from the ground state binding energy given by Johnson and Soff to obtain the predicted wavelengths.

Transition probability data were obtained by scaling the data available for the hydrogen spectrum by Wiese *et al.* (1966)²⁰⁰ according to

$$f_{\text{Fe XXVI}} = f_{\text{Hydrogen}}$$

and

$$A_{\text{Fe XXVI}} = (26)^4 A_{\text{Hydrogen}}$$

where f and A are the oscillator strength and the radiative transition probability, respectively. We note that the f and A tabulated are not for the $nlj-n'l'j'$ transition, but for the $nl-n'l'$ doublet transition. Relativistic effects are not included in the scaling since they are quite small, of order 1% to 5%. For some of the transitions, they may be obtained from the calculations of Younger and Weiss.²⁰²

3. Explanation of Tables of Spectroscopic Data

Fe VIII, Fe XXVI, etc.

According to spectroscopic convention, Fe I indicates the first spectrum, i.e., the spectrum of the neutral atom; Fe II denotes the second spectrum, belonging to the singly ionized ion; and so on.

H-Sequence, C-Sequence, etc.

Indicates that the respective Fe ion has the same number of electrons as neutral hydrogen, neutral carbon, etc.

$\lambda(\text{\AA})$

Wavelength of listed spectral lines in Angstrom units (10^{-8} cm). Lines are grouped into multiplets, not in numerical order.

c

Superscript to the right of a wavelength means the wavelength calculated from energy level data using the Ritz combination principle.

Classification

Standard spectroscopic designation for lower (first) and upper levels generating the spectral lines; electronic configurations followed by the term in *LS*-, *jj*- or *jl*[*k*]-coupling notation. The degree sign (°) on the term indicates odd parity.

A term enclosed in parentheses refers to an intermediate state. Where only the total angular momentum J is given in successive listings, the preceding configuration and term names apply.

Energy Levels

Level values (in cm^{-1}) for lower (first) and upper (second) level of the transition. A question mark (?) after the level value indicates the classification is tentative.

Int

Roughly estimated relative intensity of a spectral line, generally visually estimated from the blackness (or density) of the line on photographic plates.

f

This column lists the absorption oscillator strength for electric dipole transitions. 1.23-1 means 1.23×10^{-1} . f -values are not given for magnetic-dipole (M1) and magnetic-quadrupole (M2) transitions.

A

Radiative transition probability in s^{-1} . 1.23+11 means 1.23×10^{11} .

Acc

Accuracy estimate for the oscillator strength and transition probability data, taken from the NIST (formerly NBS) reference tables on atomic transition probabilities (see, e.g. the introduction of Ref. 17 for detailed explanation). The accuracy is indicated by the following letter symbols, which are identical with the notation used in the NIST reference book:

- A for uncertainties within 3%
- B for uncertainties within 10%
- C for uncertainties within 25%
- D for uncertainties within 50%
- E for uncertainties greater than 50%

References

Reference sources for the data. The numbers are keyed to the bibliographic listing following the tables. When several references are listed, they are distinguished by superscripts on the numbers as follows:

- ° Reference from which the adopted wavelength value is taken.
- * Reference containing the adopted oscillator strength and/or the transition probability.
- △ Reference from which the estimated intensity is taken.

Fe VIII (K Sequence)

Ionization Energy = 1218400 cm⁻¹ (151.06 eV)

λ (Å)	Classification	Energy Levels (cm ⁻¹)	Int.	<i>f</i> /Type	<i>A</i> (s ⁻¹)	Acc.	References		
232.876	$3p^6 3d^2 D_{5/2}$	$3p^5(^2P^{\circ}) 3d^2(^1G) ^2F_{5/2}^{\circ}$	1836	431250	20		168		
231.884	$3/2$	$5/2$	0	431250	200		168		
231.097	$5/2$	$7/2$	1836	434555	260		168		
224.305	$3p^6 3d^2 D_{5/2}$	$3p^5(^2P^{\circ}) 3d^2(^1D) ^2F_{7/2}^{\circ}$	1836	447658	500		168		
218.564	$5/2$	$5/2$	1836	459367	60		168		
217.691	$3/2$	$5/2$	0	459367	300		168		
197.362	$3p^6 3d^2 D_{5/2}$	$3p^5(^2P^{\circ}) 3d^2(^1S) ^2P_{3/2}^{\circ}$	1836	508518	230		168		
196.650	$3/2$	$3/2$	0	508518	40		168		
192.004	$3/2$	$1/2$	0	520822	200		168		
195.972	$3p^6 3d^2 D_{3/2}$	$3p^6 4p ^2P_{1/2}^{\circ}$	0	510277	400		144, 168 ^Δ		
194.662	$5/2$	$3/2$	1836	515550	500		144, 168 ^Δ		
193.967	$3/2$	$3/2$	0	515550	100		144, 168 ^Δ		
187.237	$3p^6 3d^2 D_{5/2}$	$3p^5(^2P^{\circ}) 3d^2(^3F) ^2F_{5/2}^{\circ}$	1836	535909	300		3, 38, 168 ^Δ		
186.601	$3/2$	$5/2$	0	535909	600		3, 38, 109, 110, 153, 168 ^Δ		
185.213	$5/2$	$7/2$	1836	541755	700		3, 38, 109, 110, 153, 168 ^Δ		
168.929	$3p^6 3d^2 D_{3/2}$	$3p^5(^2P^{\circ}) 3d^2(^3P) ^2P_{1/2}^{\circ}$	0	591964	250		168		
168.545	$5/2$	$3/2$	1836	595152	450		41, 168 [°]		
168.024	$3/2$	$3/2$	0	595152	100		168		
168.172	$3p^6 3d^2 D_{5/2}$	$3p^5(^2P^{\circ}) 3d^2(^3F) ^2D_{5/2}^{\circ}$	1836	596463	500		3, 38, 41, 109, 110, 152, 168 ^Δ		
168.002	$5/2$	$3/2$	1836	597065	150		38, 109, 110, 168 ^Δ		
167.656	$3/2$	$5/2$	0	596463	200		38, 109, 110, 168 ^Δ		
167.486	$3/2$	$3/2$	0	597065	400		3, 38, 41, 109, 110, 152, 168 ^Δ		
131.255	$3p^6 3d^2 D_{5/2}$	$3p^6 4f ^2F_{5/2}^{\circ}$	1836	763703	80		168		
131.240	$5/2$	$7/2$	1836	763799	200		3, 144, 152, 168 ^Δ		
130.941	$3/2$	$5/2$	0	763703	150		3, 144, 152, 168 ^Δ		
120.31	$3p^6 3d^2 D_{5/2}$	$3p^5 3d(^3P^{\circ}) 4s ^4P_{3/2}^{\circ}$	1836	833000			39, 92 [°]		
119.380	$3p^6 3d^2 D_{3/2}$	$3p^5 3d(^3P^{\circ}) 4s ^2P_{1/2}^{\circ}$	0	837661	15	4.1-2	3.8+10	D	39, 92, 107*, 168 ^Δ
118.907	$5/2$	$3/2$	1836	842829	25	4.7-2	3.3+10	D	39, 92, 107*, 168 ^Δ
118.648	$3/2$	$3/2$	0	842829	3	1.1-2	5.2+9	D	39, 92, 107*, 168 ^Δ
118.300	$3p^6 3d^2 D_{5/2}$	$3p^5 3d(^3F^{\circ}) 4s ^4F_{7/2}^{\circ}$	1836	847145	8	6.2-3	2.2+9	D	39, 92, 107*, 168 ^Δ
117.661	$3/2$	$5/2$	0	849899	8	1.0-2	3.2+9	D	39, 92, 107*, 168 ^Δ
117.254	$3/2$	$3/2$	0	852849	1				168
117.197	$3p^6 3d^2 D_{5/2}$	$3p^5 3d(^3F^{\circ}) 4s ^2F_{7/2}^{\circ}$	1836	855100	60	8.8-2	3.2+10	D	39, 92, 107*, 168 ^Δ
116.442	$5/2$	$5/2$	1836	860615	1	4.5-3	2.2+9	D	39, 92, 107*, 168 ^Δ
116.196	$3/2$	$5/2$	0	860615	35	1.2-1	4.0+10	D	39, 92, 107*, 168 ^Δ
114.564	$3p^6 3d^2 D_{5/2}$	$3p^5 3d(^3D^{\circ}) 4s ^4D_{7/2}^{\circ}$	1836	874711	4	7.2-3	2.7+9	D	39, 92, 107*, 168 ^Δ
114.295	$5/2$	$5/2$	1836	876765	5	9.8-3	5.0+9	D	39, 92, 107*, 168 ^Δ
114.05	$3/2$	$5/2$	0	876765					39, 92, 168 [°]
113.963	$3/2$	$3/2$	0	877476		5.8-3	3.0+9	D	107*, 168 [°]
113.861	$3/2$	$1/2$	0	878264	1				168
114.0 [°]	$3p^6 3d^2 D_{5/2}$	$3p^5 3d(^1F^{\circ}) 4s ^2F_{5/2}^{\circ}$	1836	879021		2.8-2	1.5+10	D	107
113.763	$3/2$	$5/2$	0	879021	7				168
112.932	$5/2$	$7/2$	1836	887325	25	5.5-2	2.2+10	D	39, 92, 107*, 168 ^Δ
113.463	$3p^6 3d^2 D_{3/2}$	$3p^5 3d(^1D^{\circ}) 4s ^2D_{3/2}^{\circ}$	0	881345	5	3.5-2	1.9+10	D	107*, 168 ^Δ
113.315	$5/2$	$5/2$	1836	884331	10	3.7-3	1.9+9	D	107*, 168 ^Δ
113.081	$3/2$	$5/2$	0	884331	1	2.4-2	8.4+9	D	107*, 168 ^Δ
112.704	$3p^6 3d^2 D_{5/2}$	$3p^5 3d(^3D^{\circ}) 4s ^2D_{5/2}^{\circ}$	1836	889113	2	1.1-2	8.7+9	D	39, 92, 107*, 168 ^Δ
112.486	$5/2$	$5/2$	1836	890845	20	7.3-2	3.8+10	D	39, 92, 107*, 168 ^Δ
112.472	$3/2$	$3/2$	0	889113	15	6.1-2	3.2+10	D	39, 92, 107*, 168 ^Δ
112.252	$3/2$	$5/2$	0	890845	1	1.9-2	6.7+9	D	39, 92, 107*, 168 ^Δ

Fe VIII (K Sequence) Ionization Energy = 1218400 cm⁻¹ (151.06 eV) — Continued

λ (Å)	Classification	Energy Levels (cm ⁻¹)	Int.	f /Type	A (s ⁻¹)	Acc.	References
108.077	$3p^6 3d^2 D_{5/2}$	$3p^6 5f^2 F_{7/2}^o$	1836	927102	30		144, 168 ^{°A}
107.868	$3/2$	$5/2$	0	927059	25		144, 168 ^{°A}
98.548	$3p^6 3d^2 D_{5/2}$	$3p^6 6f^2 F_{7/2}^o$	1836	1016570	10		2, 144, 168 ^{°A}
98.371	$3/2$	$5/2$	0	1016560	8		2, 144, 168 ^{°A}
93.616	$3p^6 3d^2 D_{5/2}$	$3p^6 7f^2 F_{7/2}^o$	1836	1070029	5		2, 144, 168 ^{°A}
93.469	$3/2$	$5/2$	0	1069873	4		2, 144, 168 ^{°A}

Fe IX (Ar Sequence) Ionization Energy = 1884000 cm⁻¹ (233.6 eV)

λ (Å)	Classification	Energy Levels (cm ⁻¹)	Int.	f /Type	A (s ⁻¹)	Acc.	References
4585.3	$3p^5 3d^3 F_2^o$	$3p^5 3d^3 D_3^o$	433818.8	455612.2	M1		57, 125 [°]
3800.8	3	3	429310.9	455612.2	M1		57, 125 [°]
3471.6	2	2	433818.8	462616.6	M1		57, 125 [°]
3355.1	4	3	425809.9	455612.2	M1		57, 125 [°]
3000.	3	2	429310.9	462616.6	M1		57, 124 [°]
4359.4	$3p^5 3d^3 F_2^o$	$3p^5 3d^3 D_2^o$	433818.8	456752.7	M1		57, 125 [°]
3642.7	3	2	429310.9	456752.7	M1		57, 125 [°]
3124.0	$3p^5 3d^3 F_2^o$	$3p^5 3d^3 F_3^o$	433818.8	465828.4	M1		57, 125 [°]
2497.5	4	3	425809.9	465828.4	M1		98, 172 [°]
2042.35	$3p^5 3d^3 P_2^o$	$3p^5 3d^3 D_2^o$	413669.2	462616.6	M1		98, 172 [°]
1841.57	1	2	408315.1	462616.6	M1		98, 129, 172 [°]
1917.21	$3p^5 3d^3 P_2^o$	$3p^5 3d^3 F_3^o$	413669.2	465828.4	M1		98, 128, 129, 172 [°]
604.880	$3s^2 3p^5 3d^1 P_1^o$	$3s 3p^6 3d^1 D_2$	584546	749871	0		178
380.079	$3s^2 3p^5 3d^1 F_3^o$	$3s 3p^6 3d^3 D_3$	465828.4	728935	2		178
378.629	$3s^2 3p^5 3d^3 D_2^o$	$3s 3p^6 3d^3 D_1$	462616.6	726734	0		178
377.443	2	2	462616.6	727560	2		178
375.773	1	1	460616	726734	2		178
374.605	1	2	460616	727560	0		178
369.260	$3s^2 3p^5 3d^1 D_2^o$	$3s 3p^6 3d^3 D_2$	456752.7	727560	1		178
352.072	$3s^2 3p^5 3d^1 F_3^o$	$3s 3p^6 3d^1 D_2$	465828.4	749871	4		178
348.124	$3s^2 3p^5 3d^3 D_2^o$	$3s 3p^6 3d^1 D_2$	462616.6	749871	1		178
339.838	3	2	455612.2	749871	2		178
341.390	$3s^2 3p^5 3d^3 F_2^o$	$3s 3p^6 3d^3 D_1$	433818.8	726734	4		178
335.294	3	2	429310.9	727560	5		178
329.890	4	3	425809.9	728935	6		178
341.150	$3s^2 3p^5 3d^1 D_2^o$	$3s 3p^6 3d^1 D_2$	456752.7	749871	4		178
319.426	$3s^2 3p^5 3d^3 P_2^o$	$3s 3p^6 3d^3 D_1$	413669.2	726734	0		178
318.586	2	2	413669.2	727560	2		178
317.194	2	3	413669.2	728935	5		178
313.234	1	2	408315.1	727560	4		178
311.563	0	1	405772	726734	2		178

Fe IX (Ar Sequence) Ionization Energy = 1884000 cm⁻¹ (233.6 eV) — Continued

λ (Å)	Classification		Energy Levels (cm ⁻¹)		Int.	f /Type	A (s ⁻¹)	Acc.	References
244.911	$3p^6\ ^1S_0$	$3p^53d\ ^3P_1^o$	0	408315.1	20	2.4-4	8.7+6	E	4°, 57, 107*, 178 ^A , 184
241.739	₀	₂	0	413669.2	30				4°, 57, 178 ^A , 184
218.935	$3p^6\ ^1S_0$	$3p^53d\ ^1D_2^o$	0	456752.7	5				4°, 57, 178 ^A , 184
217.100	$3p^6\ ^1S_0$	$3p^53d\ ^3D_1^o$	0	460616	10	4.3-3	2.0+8	E	3, 4°, 57, 107*, 178 ^A , 184
171.073	$3p^6\ ^1S_0$	$3p^53d\ ^1P_1^o$	0	584546	120	2.65	2.01+11	C+	3, 4°, 38, 41, 57, 67, 91, 107*, 109, 110, 152, 178 ^A , 184
118.27	$3p^53d\ ^1F_3^o$	$3p^5(^2P_{3/2}^o)4f\ ^2[\frac{7}{2}]_4$	465828.4	1311750	2				186
116.803	$3p^53d\ ^3D_3^o$	$3p^5(^2P_{3/2}^o)4f\ ^2[\frac{7}{2}]_4$	455612.2	1311750	9	4.1-1	1.6+11	E	72°, 107*, 186 ^A , 193
116.408	$3p^53d\ ^1F_3^o$	$3p^5(^2P_{1/2}^o)4f\ ^2[\frac{7}{2}]_4$	465828.4	1324800	6				186 ^A , 193
115.996	$3p^53d\ ^3D_2^o$	$3p^5(^2P_{1/2}^o)4f\ ^2[\frac{7}{2}]_3$	462616.6	1324720	7	4.6-1	1.6+11	E	72°, 107*, 186 ^A , 193
115.353	$3p^53d\ ^1D_2^o$	$3p^5(^2P_{1/2}^o)4f\ ^2[\frac{5}{2}]_3$	456752.7	1323660	7	3.9-1	1.4+11	E	72°, 107*, 186 ^A , 193
114.111	$3p^53d\ ^3F_2^o$	$3p^5(^2P_{3/2}^o)4f\ ^2[\frac{7}{2}]_3$	433818.8	1310160	7	3.7-1	1.4+11	E	72°, 107*, 186 ^A , 193
114.024	$3p^53d\ ^3F_3^o$	$3p^5(^2P_{3/2}^o)4f\ ^2[\frac{3}{2}]_4$	429310.9	1306320	8	4.0-1	1.6+11	E	72°, 107*, 186 ^A , 193
113.793	₄	₅	425809.9	1304600	10	4.8-1	2.0+11	E	72°, 107*, 186 ^A , 193
112.375	$3p^53d\ ^3P_2^o$	$3p^5(^2P_{3/2}^o)4f\ ^2[\frac{3}{2}]_2$	413669.2	1302840	5				186 ^A , 193
112.017	₁	₁	408315.1	1300920	4				186 ^A , 193
111.791	₁	₂	408315.1	1302840	5	3.9-1	1.2+11	E	72°, 107*, 186 ^A , 193
111.713	₀	₁	405772	1300920	3	5.6-1	1.0+11	E	72°, 107*, 186 ^A , 193
112.096	$3p^53d\ ^3P_2^o$	$3p^5(^2P_{3/2}^o)4f\ ^2[\frac{5}{2}]_3$	413669.2	1305760	8	4.1-1	1.6+11	E	72°, 107*, 186 ^A , 193
105.208	$3p^6\ ^1S_0$	$3p^5(^2P_{3/2}^o)4s\ (\frac{3}{2}, \frac{1}{2})^o$	0	950500	30	1.6-1	3.2+10	D	3 ^A , 63, 72°, 91, 107*, 145, 152, 194, 201
103.566	$3p^6\ ^1S_0$	$3p^5(^2P_{1/2}^o)4s\ (\frac{3}{2}, \frac{1}{2})^o$	0	965570	35	2.5-1	5.2+10	D	3 ^A , 66, 72°, 91, 107*, 145, 152, 194, 201
83.457	$3p^6\ ^1S_0$	$3p^54d\ ^3P_1^o$	0	1198220	15	3.1-1	9.9+10	D	2, 3 ^A , 67, 72°, 107*, 152, 186
82.430	$3p^6\ ^1S_0$	$3p^54d\ ^1P_1^o$	0	1213150	20	1.7-1	5.6+10	D	2, 3 ^A , 67, 72°, 107*, 152, 186
73.63	$3p^6\ ^1S_0$	$3p^5(^2P_{3/2}^o)5s\ (\frac{3}{2}, \frac{1}{2})^o$	0	1358140	2				2 ^A , 186
72.891	$3s^23p^6\ ^1S_0$	$3s3p^64p\ ^1P_1^o$	0	1371910					133
72.85	$3p^6\ ^1S_0$	$3p^5(^2P_{1/2}^o)5s\ (\frac{3}{2}, \frac{1}{2})^o$	0	1372670	1				2

Fe x (Cl Sequence)		Ionization Energy = 2114000 cm ⁻¹ (262.1 eV)							
λ (Å)	Classification	Energy Levels (cm ⁻¹)		Int.	f /Type	A (s ⁻¹)	Acc.	References	
6374.51	$3p^5 \ ^2P_{3/2}$	$3p^5 \ ^2P_{1/2}$	0	15683.1		M1	6.94+1	C	114°, 124, 125, 135*, 151
5539.1	$3p^4(^3P)3d \ ^4F_{7/2}$	$3p^4(^3P)3d \ ^2F_{7/2}$	422795	440840		M1			57, 125°, 151, 177
4311.8	$9/2$	$7/2$	417653	440840		M1			57, 125°, 151, 177
3577.1	$3p^4(^3P)3d \ ^4F_{7/2}$	$3p^4(^1D)3d \ ^2G_{9/2}$	422795	450751		M1			57, 125°, 151, 177
3533.6	$7/2$	$7/2$	422795	451084		M1			57, 125°, 151, 177
3020.1	$9/2$	$9/2$	417653	450751		M1			57°, 177
3454.2	$3p^4(^3P)3d \ ^4D_{7/2}$	$3p^4(^3P)3d \ ^4F_{9/2}$	388709	417653		M1			57, 125°, 151, 177
1918.25	$3p^4(^3P)3d \ ^4D_{7/2}$	$3p^4(^3P)3d \ ^2F_{7/2}$	388709	440840		M1			57, 172°, 177
1611.70	$3p^4(^3P)3d \ ^4D_{7/2}$	$3p^4(^1D)3d \ ^2G_{9/2}$	388709	450751		M1			57, 172°, 177
1603.21	$7/2$	$7/2$	388709	451084		M1			57, 172°, 177
1582.56	$3p^4(^3P)3d \ ^4F_{7/2}$	$3p^4(^1D)3d \ ^2F_{7/2}$	422795	485983		M1			57, 172°, 177
1463.49	$9/2$	$7/2$	417653	485983		M1			57, 172°, 177
366.667	$3s^23p^4(^3P)3d \ ^4F_{5/2}$	$3s3p^5(^3P^o)3d \ ^4F_{7/2}^o$	426763	699492	1				177
365.144	$7/2$	$9/2$	422795	696661	0				177
364.589	$3/2$	$5/2$	428298	702585	0				177
362.547	$5/2$	$5/2$	426763	702585	2				177
361.409	$7/2$	$7/2$	422795	699492	1				177
360.833	$3/2$	$3/2$	428298	705430	1				177
358.867	$5/2$	$3/2$	426763	705430	0				177
358.414	$9/2$	$9/2$	417653	696661	4				177
354.824	$9/2$	$7/2$	417653	699492	0				177
365.543	$3s^23p^5 \ ^2P_{1/2}^o$	$3s3p^6 \ ^2S_{1/2}$	15683.1	289249	1	3.5-2	1.7+9	E	4°, 70, 107*, 176°, 195
345.723	$3/2$	$1/2$	0	289249	10	3.5-2	3.9+9	E	4°, 68, 70, 107*, 176°, 195
324.726	$3s^23p^4(^3P)3d \ ^4D_{7/2}$	$3s3p^5(^3P^o)3d \ ^4F_{9/2}^o$	388709	696661	5				177
321.766	$7/2$	$7/2$	388709	699492	5				177
321.766	$5/2$	$7/2$	388709	699492	5				177
319.936	$3/2$	$5/2$	390050	702585	2				177
318.599	$5/2$	$5/2$	388709	702585	3				177
318.599	$1/2$	$3/2$	391555	705430	3				177
317.043	$3/2$	$3/2$	390050	705430	0				177
257.262	$3p^5 \ ^2P_{3/2}^o$	$3p^4(^3P)3d \ ^4D_{5/2}$	0	388709	45				4°A, 21, 177
256.38	$3/2$	$3/2$	0	390050	10				4°A, 21, 41, 177
240.243	$3p^5 \ ^2P_{1/2}^o$	$3p^4(^1D)3d \ ^2P_{3/2}$	15683.1	431928					21
238.72	$3p^5 \ ^2P_{1/2}^o$	$3p^4(^1D)3d \ ^2D_{3/2}$	15683.1	434614					21
230.089	$3/2$	$3/2$	0	434614					21°, 41
234.356	$3p^5 \ ^2P_{3/2}^o$	$3p^4(^3P)3d \ ^4F_{5/2}$	0	426763	15	5.3-4	4.3+7	E	4°A, 21, 108*, 177
229.99	$3p^5 \ ^2P_{3/2}^o$	$3p^4(^3P)3d \ ^4P_{1/2}$	0	434800		1.2-3	3.0+8	D	21°, 107*
226.31	$3/2$	$5/2$	0	441853					21
220.882	$3p^5 \ ^2P_{3/2}^o$	$3p^4(^3P)3d \ ^2F_{5/2}$	0	452730?					21
209.776	$3p^5 \ ^2P_{3/2}^o$	$3p^4(^1D)3d \ ^2F_{5/2}$	0	476699?		3.3-4	3.0+7	E	21°, 107*
201.556	$3p^5 \ ^2P_{1/2}^o$	$3p^4(^1S)3d \ ^2D_{3/2}$	15683.1	511800		1.4-2	1.1+9	D	21°, 107*
195.399	$3/2$	$3/2$	0	511800		3.8-3	6.6+8	D	21°, 107*
190.044	$3p^5 \ ^2P_{1/2}^o$	$3p^4(^1D)3d \ ^2S_{1/2}$	15683.1	541879	50	2.3-1	4.2+10	D	3°A, 4, 21, 41, 62, 107*, 152
184.542	$3/2$	$1/2$	0	541879	60	3.8-1	1.5+11	D	3°A, 4, 21, 41, 62, 107*, 152
182.310	$3p^5 \ ^2P_{1/2}^o$	$3p^4(^3P)3d \ ^2P_{3/2}$	15683.1	564198	30	4.0-2	4.0+9	E	3°A, 4, 21, 38, 62, 67, 107*, 152
180.407	$1/2$	$1/2$	15683.1	569985	90	7.0-1	1.4+11	E	3°A, 21, 38, 41, 62, 67, 107*
177.243	$3/2$	$3/2$	0	564198	80	9.0-1	1.9+11	E	3°A, 4, 21, 38, 62, 67, 107*, 110, 152

Fe x (Cl Sequence) Ionization Energy = 2114000 cm⁻¹ (262.1 eV)

λ (Å)	Classification		Energy Levels (cm ⁻¹)		Int.	f /Type	A (s ⁻¹)	Acc.	References
175.474	3/2	1/2	0	569985	30	1.1-1	4.8+10	E	3 ^a , 21, 38, 62, 67, 107*, 152
175.266	3p ⁵ 2P _{1/2}	3p ⁴ (³ P)3d 2D _{3/2}	15683.1	586244	50	1.9	2.1+11	D	3 ^a , 21, 38, 41, 62, 67, 107*, 110, 127, 152
174.534	3/2	5/2	0	572954	90	1.5	2.2+11	D	3 ^a , 21, 38, 41, 62, 67, 107*, 110, 127, 152
170.58	3/2	3/2	0	586244	10	2.9-2	6.6+9	D	3 ^a , 21, 38, 62, 67, 107*, 127
144.328	3p ⁴ (¹ D)3d 2F _{7/2}	3p ⁴ (¹ D)4p 2D _{5/2}	485983	1178850		3.3-2	1.4+10	D	72°, 107*
140.678	3p ⁴ (¹ D)3d 2G _{7/2}	3p ⁴ (¹ D)4p 2F _{5/2}	451084	1161930		3.8-2	1.7+10	E	72°, 107*
139.868	9/2	7/2	450751	1165710		5.2-2	2.2+10	D	72°, 107*
140.296	3p ⁴ (³ P)3d 4F _{3/2}	3p ⁴ (³ P)4p 4D _{7/2}	417653	1130430		5.2-2	2.2+10	D	72°, 107*
137.027	3p ⁴ (³ P)3d 4D _{7/2}	3p ⁴ (³ P)4p 4P _{3/2}	388709	1118490		3.1-2	1.5+10	D	72°, 107*
104.638	3p ⁴ (¹ D)3d 2F _{7/2}	3p ⁴ (¹ D)4f 2G _{3/2}	485983	1441660		4.3-1	2.1+11	D	72°, 107*
104.248	5/2	7/2	476699?	1435950		3.1-1	1.4+11	D	72°, 107*
103.724	3p ⁴ (³ P)3d 2F _{5/2}	3p ⁴ (³ P)4f 2G _{7/2}	452730?	1416800		3.6-1	1.7+11	E	72°, 107*
103.164	7/2	9/2	440840	1408650					72
103.319	3p ⁴ (¹ S)3d 2D _{5/2}	3p ⁴ (¹ S)4f 2F _{7/2}				5.5-1	2.6+11	D	72°, 107*
102.829	3/2	5/2	511800	1484290		4.9-1	2.1+11	D	72°, 107*
102.348	3p ⁴ (³ P)3d 4F _{7/2}	3p ⁴ (³ P)4f 4G _{3/2}	422795	1399850					72
102.095	9/2	11/2	417653	1397130		5.5-1	2.9+11	D	72°, 107*
101.846	3/2	5/2	428298	1410170		3.9-1	1.7+11	E	72°, 107*
101.733	5/2	7/2	426763	1409730		3.8-1	1.8+11	D	72°, 107*
102.192	3p ⁴ (¹ D)3d 2G _{3/2}	3p ⁴ (¹ D)4f 2H _{11/2}	450751	1429300		5.5-1	2.9+11	D	72°, 107*
101.435	3p ⁴ (³ P)3d 4F _{7/2}	3p ⁴ (³ P)4f 2G _{3/2}	422795	1408650					72
100.026	3p ⁴ (³ P)3d 4D _{7/2}	3p ⁴ (³ P)4f 4F _{3/2}	388709	1388450		4.9-1	2.6+11	D	72°, 107*
97.838	3p ⁵ 2P _{3/2}	3p ⁴ (³ P)4s 4P _{5/2}	0	1022100	20				3 ^a , 55°, 67, 152, 194
97.122	3/2	3/2	0	1029630	25	5.0-2	3.5+10	D	3 ^a , 55°, 67, 107*, 152, 194
97.591	3p ⁵ 2P _{1/2}	3p ⁴ (³ P)4s 2P _{3/2}	15683.1	1040350	0	2.0-2	7.0+9	E	55 ^a , 67, 107*, 194, 201
96.788	1/2	1/2	15683.1	1048890	2	1.1-1	7.8+10	D	55 ^a , 67, 107*, 194, 201
96.122	3/2	3/2	0	1040350	30	1.2-1	8.7+10	D	3 ^a , 41, 55°, 67, 107*, 152, 194
95.338	3/2	1/2	0	1048890	1	4.0-2	5.9+10	D	55 ^a , 67, 107*, 194
95.374	3p ⁵ 2P _{1/2}	3p ⁴ (¹ D)4s 2D _{3/2}	15683.1	1064190	15	1.5-1	5.5+10	D	3 ^a , 55°, 67, 107*, 152, 194, 201
94.012	3/2	5/2	0	1063690	35	9.3-2	4.7+10	D	3 ^a , 55°, 67, 152, 194, 201
78.769	3p ⁵ 2P _{1/2}	3p ⁴ (³ P)4d 2D _{3/2}	15683.1	1285180	4	7.5-2	4.0+10	E	67 ^a , 72°, 107*
77.865	3/2	5/2	0	1284270	8	2.2-1	1.6+11	D	67 ^a , 72°, 107*
77.812	3/2	3/2	0	1285180		7.3-2	8.0+10	E	72°, 107*
78.151	3p ⁵ 2P _{1/2}	3p ⁴ (³ P)4d 2P _{3/2}	15683.1	1295260		8.0-2	4.4+10	D	72°, 107*
77.728	3p ⁵ 2P _{3/2}	3p ⁴ (³ P)4d 4F _{5/2}	0	1286540		3.8-2	2.8+10	D	72°, 107*
77.627	3p ⁵ 2P _{3/2}	3p ⁴ (³ P)4d 2F _{5/2}	0	1288210		6.5-2	4.8+10	D	72°, 107*
76.822	3p ⁵ 2P _{1/2}	3p ⁴ (¹ D)4d 2P _{1/2}	15683.1	1317390		1.6-1	1.8+11	D	72°, 107*
76.006	3/2	3/2	0	1315690		1.1-1	1.3+11	D	72°, 107*
76.495	3p ⁵ 2P _{1/2}	3p ⁴ (¹ D)4d 2D _{3/2}	15683.1	1322960		2.4-1	1.4+11	D	72°, 107*
75.685	3/2	5/2	0	1321270		1.0-1	7.8+10	D	72°, 107*

Fe XI (S Sequence) Ionization Energy = 2341000 cm⁻¹ (290.2 eV)

λ (Å)	Classification		Energy Levels (cm ⁻¹)		Int.	f /Type	A (s ⁻¹)	Acc.	References
7891.8	$3p^4\ ^3P_2$	$3p^4\ ^3P_1$	0	12667.9		M1	4.37+1	C	56, 114, 125°, 135*
3986.8	$3p^4\ ^3P_1$	$3p^4\ ^1D_2$	12667.9	37743.6		M1	9.44	C	56, 125°, 135*
2648.71	$3p^4\ ^3P_2$	$3p^4\ ^1D_2$	0	37743.6		M1	9.23+1	C	135*, 172°
1467.06	$3p^4\ ^3P_1$	$3p^4\ ^1S_0$	12667.9	80814.7		M1	9.90+2	C	31, 32, 49, 128, 129, 135*, 172°, 183
406.811°	$3s^23p^4\ ^1D_2$	$3s3p^5\ ^3P_2^o$	37743.6	283558		1.0-3	4.0+7	E	107
369.154	$3s^23p^4\ ^3P_1$	$3s3p^5\ ^3P_2^o$	12667.9	283558	2	1.8-2	5.3+8	C	4, 70, 107*, 176° ^Δ
358.621	$3s^23p^4\ ^3P_1$	$3s3p^5\ ^3P_2^o$	14312	293158	2	4.1-2	7.1+8	C	70, 107*, 176° ^Δ , 195
356.519	$3s^23p^4\ ^3P_1$	$3s3p^5\ ^3P_2^o$	12667.9	293158	1	1.0-2	5.2+8	C	4, 70, 107*, 176° ^Δ , 195
352.661	$3s^23p^4\ ^3P_1$	$3s3p^5\ ^3P_2^o$	0	283558	6	3.2-2	1.7+9	C	4, 68, 70, 107*, 176° ^Δ , 195
349.046	$3s^23p^4\ ^3P_1$	$3s3p^5\ ^3P_2^o$	12667.9	299163	2	1.4-2	2.3+9	C	70, 107*, 176° ^Δ , 195
341.113	$3s^23p^4\ ^3P_1$	$3s3p^5\ ^3P_2^o$	0	293158	3	1.2-2	1.1+9	C	4, 70, 107*, 176° ^Δ , 195
355.837	$3s^23p^4\ ^1S_0$	$3s3p^5\ ^1P_1^o$	80814.7	361842	0	9.4-3	1.6+8	D	107*, 176° ^Δ
308.544	$3s^23p^4\ ^1D_2$	$3s3p^5\ ^1P_1^o$	37743.6	361842		6.4-2	7.5+9	C	4°, 41, 107*, 195
276.364°	$3s^23p^4\ ^3P_2$	$3s3p^5\ ^1P_1^o$	0	361842		1.4-3	2.0+8	E	107
201.737	$3p^4\ ^1D_2$	$3p^3(^2D^o)3d\ ^3S_1^o$	37743.6	533450		2.3-1	6.3+10	E	21°, 107*
201.575	$3p^4\ ^3P_2$	$3p^3(^2P^o)3d\ ^3P_2^o$	0	496090		2.2-2	3.6+9	D	21°, 41, 107*
198.549	$3p^4\ ^1D_2$	$3p^3(^2D^o)3d\ ^3P_1^o$	37743.6	541390					21°, 70
192.819	$3p^4\ ^3P_1$	$3p^3(^2D^o)3d\ ^3P_2^o$	12667.9	531290	50	2.0-1	2.2+10	D	3° ^Δ , 4, 21, 41, 62, 67, 70, 107*, 152
189.735	$3p^4\ ^3P_1$	$3p^3(^2D^o)3d\ ^3P_2^o$	14312	541390					21
189.129	$3p^4\ ^3P_1$	$3p^3(^2D^o)3d\ ^3P_2^o$	12667.9	541390					21°, 41
189.017	$3p^4\ ^3P_1$	$3p^3(^2D^o)3d\ ^3P_2^o$	12667.9	541720		2.5-1	1.4+11	D	21°, 107*
188.219	$3p^4\ ^3P_1$	$3p^3(^2D^o)3d\ ^3P_2^o$	0	531290	70	5.9-1	1.1+11	D	3° ^Δ , 4, 21, 41, 62, 67, 70, 107*, 152
192.641	$3p^4\ ^3P_0$	$3p^3(^2D^o)3d\ ^3S_1^o$	14312	533450		2.3-1	1.4+10	E	21°, 107*
192.020	$3p^4\ ^3P_0$	$3p^3(^2D^o)3d\ ^3S_1^o$	12667.9	533450		1.6-1	2.9+10	E	21°, 41, 107*
187.446	$3p^4\ ^3P_0$	$3p^3(^2D^o)3d\ ^3S_1^o$	0	533450		3.2-2	1.0+10	E	21°, 107*
189.940	$3p^4\ ^3P_2$	$3p^3(^2D^o)3d\ ^3P_2^o$	0	526480					21
184.800	$3p^4\ ^1D_2$	$3p^3(^2D^o)3d\ ^1D_2^o$	37743.6	578860	30	6.3-1	1.2+11	D	3° ^Δ , 21, 62, 67, 107*, 152
184.41	$3p^4\ ^1S_0$	$3p^3(^2P^o)3d\ ^1P_1^o$	80814.7	623080		2.2	1.4+11	D	21°, 70, 107*
182.173	$3p^4\ ^3P_1$	$3p^3(^4S^o)3d\ ^3D_2^o$	12667.9	561610	60				3° ^Δ , 4, 21, 41, 67, 109, 110, 152
181.140	$3p^4\ ^3P_1$	$3p^3(^4S^o)3d\ ^3D_2^o$	14312	566380	40				3° ^Δ , 21, 41, 67, 109, 110, 152
180.600	$3p^4\ ^3P_1$	$3p^3(^4S^o)3d\ ^3D_2^o$	12667.9	566380	30				3° ^Δ , 21, 70, 152
180.407	$3p^4\ ^3P_1$	$3p^3(^4S^o)3d\ ^3D_2^o$	0	554300	90				3° ^Δ , 21, 41, 67, 109, 110, 152
178.060	$3p^4\ ^3P_1$	$3p^3(^4S^o)3d\ ^3D_2^o$	0	561610	40				3° ^Δ , 4, 21, 41, 67, 109, 110, 152
179.762	$3p^4\ ^1D_2$	$3p^3(^2D^o)3d\ ^1F_3^o$	37743.6	594030	40	1.1	1.6+11	D	3° ^Δ , 21, 41, 107*, 110, 152
176.620	$3p^4\ ^3P_1$	$3p^3(^2D^o)3d\ ^1D_2^o$	12667.9	578860		6.7-2	8.6+9	D	21°, 107*
124.725	$3p^3(^2D^o)3d\ ^1G_4^o$	$3p^3(^2D^o)4p\ ^1F_3$				4.0-2	2.2+10	D	72°, 107*
123.822	$3p^3(^2D^o)3d\ ^3G_3^o$	$3p^3(^2D^o)4p\ ^3F_2$				3.6-2	2.2+10	E	72°, 107*
123.49	$3p^3(^2D^o)3d\ ^3G_3^o$	$3p^3(^2D^o)4p\ ^3F_2$				5.0-2	2.7+10	D	72°, 107*
123.49	$3p^3(^2D^o)3d\ ^3G_3^o$	$3p^3(^2D^o)4p\ ^3F_2$				3.0-2	1.7+10	E	72°, 107*
123.572	$3p^3(^2P^o)3d\ ^3F_3^o$	$3p^3(^2P^o)4p\ ^3D_2$				5.9-2	3.6+10	E	72°, 107*

Fe XI (S Sequence) Ionization Energy = 2341000 cm⁻¹ (290.2 eV) — Continued

λ (Å)	Classification	Energy Levels (cm ⁻¹)	Int.	f /Type	A (s ⁻¹)	Acc.	References	
121.747	$3p^3(^4S^o)3d^5D_3^o$	$3p^3(^4S^o)4p^5P_2$		3.3-2	2.1+10	D	72°, 107*	
121.419	4	3		5.0-2	2.9+10	D	72°, 107*	
93.433	$3p^3(^2D^o)3d^1G_3^o$	$3p^3(^2D^o)4f^3F_5$		5.1-1	3.2+11	D	72°, 107*	
93.018	$3p^3(^2P^o)3d^3F_2^o$	$3p^3(^2P^o)4f^3G_3$					72	
92.9	$3p^3(^2D^o)3d^3D_3^o$	$3p^3(^2P^o)4f^3F_4$					72	
92.8	2	3					72	
92.87	$3p^3(^2D^o)3d^3G_5^o$	$3p^3(^2D^o)4f^3H_6$		6.0-1	3.9+11	D	72°, 107*	
92.87	3	4		5.7-1	3.4+11	D	72°, 107*	
92.81	4	5					72	
91.733	$3p^3(^4S^o)3d^5D_3^o$	$3p^3(^4S^o)4f^5F_5$		6.3-1	4.1+11	D	72°, 107*	
91.63	1	2		4.8-1	2.3+11	D	72°, 107*	
91.63	3	4		5.5-1	3.4+11	D	72°, 107*	
91.63	2	3		4.9-1	2.8+11	D	72°, 107*	
91.63	$3p^3(^2D^o)3d^3F_4^o$	$3p^3(^2D^o)4f^3G_5$					72	
91.472	3	4		4.1-1	2.5+11	D	72°, 107*	
91.394	2	3		4.5-1	2.6+11	D	72°, 107*	
90.345	$3p^4^3P_0$	$3p^3(^4S^o)4s^3S_1^o$	14312 1121230	0	8.0-2	2.0+10	E	54° ^A , 107*, 194
90.205	1	1	12667.9 1121230	1	6.7-2	5.5+10	D	41, 54° ^A , 107*, 194
89.185	2	1	0 1121230	25	9.2-2	1.3+11	D	3 ^A , 54°, 107*, 194
89.861 ^c	$3p^4^1S_0$	$3p^3(^2P^o)4s^1P_1^o$	80814.7 1193640		2.5-1	6.9+10	D	107
89.104	$3p^4^1D_2$	$3p^3(^2D^o)4s^1D_2^o$	37743.6 1160030	20	1.6-1	1.3+11	D	3 ^A , 54°, 107*, 152
88.167	$3p^4^3P_0$	$3p^3(^2D^o)4s^3D_1^o$	14312 1148590	0	6.0-2	2.0+10	E	54° ^A , 107*
88.029	1	1	12667.9 1148590	0	4.7-2	4.0+10	D	54° ^A , 107*, 152, 194, 201
87.995	1	2	12667.9 1149100	0	4.3-2	2.2+10	D	54° ^A , 107*, 152, 201
87.025	2	2	0 1149100	25	4.0-2	3.5+10	D	3 ^A , 54°, 107*, 152, 194
86.772	2	3	0 1152450	30	8.6-2	5.4+10	D	3 ^A , 54°, 107*, 152, 194, 201
86.513	$3p^4^1D_2$	$3p^3(^2P^o)4s^1P_1^o$	37743.6 1193640	1	5.6-2	8.3+10	D	54° ^A , 107*
72.635	$3p^4^3P_2$	$3p^3(^4S^o)4d^3D_3^o$	0 1376750		1.8-1	1.6+11	D	72°, 107*
72.310	$3p^4^1D_2$	$3p^3(^2D^o)4d^1D_2^o$	37743.6 1420680		1.2-1	1.5+11	D	72°, 107*
72.166	$3p^4^1D_2$	$3p^3(^2D^o)4d^1F_3^o$	37743.6 1423440		3.2-1	2.9+11	D	72°, 107*

Fe XII (P Sequence) Ionization Energy = 2668000 cm⁻¹ (330.8 eV)

λ (Å)	Classification	Energy Levels (cm ⁻¹)	Int.	f /Type	A (s ⁻¹)	Acc.	References	
3072.0	$3p^3 \ ^2D_{3/2}$	$3p^3 \ ^2P_{1/2}$	41566	74109	M1	7.21+1	C	125°, 135*, 183
2565.93	$3/2$	$3/2$	41566	80515	M1	2.00+2	C	135*, 172°
2405.68	$3p^3 \ ^4S_{3/2}$	$3p^3 \ ^2D_{3/2}$	0	41566	M1	4.81+1	C	135*, 172°
2169.08	$3/2$	$5/2$	0	46075	M1	1.84	C	111, 135*, 172°
1349.40	$3p^3 \ ^4S_{3/2}$	$3p^3 \ ^2P_{1/2}$	0	74109	M1	1.73+2	C	31, 32, 49, 111, 135*, 172°
1242.00	$3/2$	$3/2$	0	80515	M1	3.17+2	C	31, 32, 49, 111, 135*, 172°
382.83	$3s^2 3p^3 \ ^2P_{3/2}$	$3s 3p^4 \ ^2D_{5/2}$	80515	341703	1.8-2	5.5+8	D	24, 70°, 107*
364.468	$3s^2 3p^3 \ ^4S_{3/2}$	$3s 3p^4 \ ^4P_{5/2}$	0	274373	35	4.8-2	D	4°A, 24, 70, 107*, 195
352.107	$3/2$	$3/2$	0	284005	20	3.3-2	D	4°A, 24, 70, 107*, 195
346.852	$3/2$	$1/2$	0	288307	10	1.6-2	D	4°A, 24, 70, 107*, 195
338.263	$3s^2 3p^3 \ ^2D_{5/2}$	$3s 3p^4 \ ^2D_{5/2}$	46075	341703	8	4.7-2	D	4°A, 24, 68, 107*, 195
335.06	$3/2$	$3/2$	41566	340020		5.8-2	D	68, 70°, 107*
291.010	$3s^2 3p^3 \ ^2D_{5/2}$	$3s 3p^4 \ ^2P_{3/2}$	46075	389706	10			4°A, 24, 41, 70
283.64	$3/2$	$1/2$	41566	394120				24, 41, 70°
230.79	$3p^3 \ ^2P_{3/2}$		80515	513850				24
219.438	$3p^3 \ ^2D_{5/2}$		46075	501800	10			4°A, 24, 70
218.562	$3p^3 \ ^2P_{3/2}$	$3p^2(^1S)3d \ ^2D_{5/2}$	80515	538040				24°
217.271	$3p^3 \ ^2D_{3/2}$		41566	501800				4°, 24
211.738	$3p^3 \ ^2D_{3/2}$		41566	513850				4°, 24, 70
210.932	$3p^3 \ ^2P_{3/2}$	$3p^2(^1D)3d \ ^2D_{5/2}$	80515	554610		5.8-2	D	24°, 107*
208.410	$1/2$	$3/2$	74109	554030		7.5-2	D	24°, 107*
209.12°	$3p^3 \ ^2D_{3/2}$	$3p^2(^3P)3d \ ^4P_{1/2}$	41566	519770		2.1-2	D	107
208.318	$3p^3 \ ^2D_{5/2}$	$3p^2(^1S)3d \ ^2D_{3/2}$	46075	526120				24
206.368	$3/2$	$3/2$	41566	526120				24
203.272	$5/2$	$5/2$	46075	538040				24
201.493	$3/2$	$5/2$	41566	538040				24
204.743	$3p^3 \ ^2P_{3/2}$	$3p^2(^1D)3d \ ^2P_{1/2}$	80515	568940		1.8-2	E	24°, 107*
202.090	$1/2$	$1/2$	74109	568940		4.5-1	E	24°, 70, 107*
201.121	$3/2$	$3/2$	80515	577740	15	3.9-1	D	4°A, 24, 70, 107*
198.555	$1/2$	$3/2$	74109	577740	7	2.5-1	D	4°A, 24, 41, 70, 107*
200.356	$3p^3 \ ^2P_{3/2}$	$3p^2(^1D)3d \ ^2S_{1/2}$	80515	579630		2.0-1	D	24°, 107*
196.923	$3p^3 \ ^2D_{5/2}$	$3p^2(^1D)3d \ ^2D_{3/2}$	46075	554030		4.3-2	D	24°, 107*
196.640	$5/2$	$5/2$	46075	554610	6	2.8-1	D	4°A, 24, 70, 107*
195.119	$3/2$	$3/2$	41566	554030	90	3.8-1	D	4°A, 24, 107*
194.920	$3/2$	$5/2$	41566	554610		2.0-2	D	24°, 107*
195.119	$3p^3 \ ^4S_{3/2}$	$3p^2(^3P)3d \ ^4P_{5/2}$	0	512510	90	8.0-1	D	3, 4°A, 24, 41, 64, 70, 107*, 152
193.509	$3/2$	$3/2$	0	516740	60	5.3-1	D	3, 4°A, 24, 41, 64, 70, 107*, 152
192.394	$3/2$	$1/2$	0	519770	25	2.5-1	D	3, 4°A, 24, 64, 70, 107*, 152
194.61	$3p^3 \ ^4S_{3/2}$		0	513850				24
191.045	$3p^3 \ ^2P_{3/2}$	$3p^2(^3P)3d \ ^2D_{5/2}$	80515	603930				4°, 24, 41, 70
190.459	$3/2$	$3/2$	80515	605480		1.3-1	E	24°, 107*
188.216	$1/2$	$3/2$	74109	605480	50	8.5-1	E	4°A, 24, 41, 70, 107*

Fe XII (P Sequence) Ionization Energy = 2668000 cm⁻¹ (330.8 eV) — Continued

λ (Å)	Classification		Energy Levels (cm ⁻¹)		Int.	f /Type	A (s ⁻¹)	Acc.	References
190.06	$3p^3 \ ^4S_{3/2}$	$3p^2(^1S)3d \ ^2D_{3/2}$	0	526120					24
189.561	$3p^3 \ ^2D_{3/2}$	$3p^2(^1D)3d \ ^2P_{1/2}$	41566	568940		1.2-2	4.5+9	E	24°, 107*
188.45	$3p^3 \ ^2D_{5/2}$	$3p^2(^3P)3d \ ^2F_{5/2}$	46075	576740		3.7-2	6.9+9	E	24°, 107*
186.880	$5/2$	$7/2$	46075	581180	15	8.0-1	1.1+11	D	3, 4 ^a , 24, 41, 67, 70, 107*, 110, 152
186.856	$3/2$	$5/2$	41566	576740		8.5-1	1.1+11	E	24°, 41, 107*
185.85 ^c	$3p^3 \ ^2D_{3/2}$	$3p^2(^1D)3d \ ^2S_{1/2}$	41566	579630		1.3-2	5.0+9	D	107
179.265	$3p^3 \ ^2D_{5/2}$	$3p^2(^3P)3d \ ^2D_{5/2}$	46075	603930					24°, 41
110.732	$3p^2(^1D)3d \ ^2G_{7/2}$	$3p^2(^1D)4p \ ^2F_{5/2}$				1.8-2	1.3+10	D	72°, 107*
110.591	$9/2$	$7/2$				4.6-2	3.1+10	D	72°, 107*
109.712	$3p^2(^3P)3d \ ^4D_{5/2}$	$3p^2(^3P)4p \ ^2D_{3/2}$							72
109.509	$3p^2(^1D)3d \ ^2F_{7/2}$	$3p^2(^3P)4p \ ^2D_{5/2}$							72
109.015	$3p^2(^3P)3d \ ^4D_{7/2}$	$3p^2(^3P)4p \ ^4P_{5/2}$							72
108.862	$3p^2(^3P)3d \ ^4F_{5/2}$	$3p^2(^3P)4p \ ^4D_{3/2}$				3.8-2	3.2+10	D	72°, 107*
108.605	$7/2$	$5/2$				4.4-2	3.3+10	D	72°, 107*
108.440	$9/2$	$7/2$				4.7-2	3.3+10	D	72°, 107*
85.669	$3p^2(^1S)3d \ ^2D_{5/2}$	$3p^2(^1S)4f \ ^2F_{7/2}$	538040	1705300					72
85.477	$3p^2(^1D)3d \ ^2G_{9/2}$	$3p^2(^1D)4f \ ^2H_{11/2}$				6.0-1	4.6+11	D	72°, 107*
85.14	$7/2$	$9/2$				4.6-1	3.4+11	D	72°, 107*
85.14	$3p^2(^3P)3d \ ^2F_{7/2}$	$3p^2(^3P)4f \ ^2G_{9/2}$	581180	1756000					72
84.86	$5/2$	$7/2$	576740	1755000					72
84.85	$3p^2(^3P)3d \ ^4D_{5/2}$	$3p^2(^3P)4f \ ^4F_{7/2}$				3.3-1	2.3+11	D	72°, 107*
84.768	$7/2$	$9/2$							72
84.52	$3p^2(^3P)3d \ ^4F_{9/2}$	$3p^2(^3P)4f \ ^4G_{11/2}$				6.7-1	5.2+11	D	72°, 107*
84.52	$5/2$	$7/2$				5.7-1	4.0+11	D	72°, 107*
84.48	$7/2$	$9/2$				6.6-1	4.9+11	D	72°, 107*
84.48	$3/2$	$5/2$				7.2-1	4.5+11	D	72°, 107*
82.837	$3p^3 \ ^2P_{3/2}$	$3p^2(^1D)4s \ ^2D_{5/2}$	80515	1287700		3.0-2	1.9+10	D	72°, 107*
82.744	$3/2$	$3/2$	80515	1289060		7.8-2	7.6+10	D	41, 72°, 107*
82.226	$3p^3 \ ^2D_{3/2}$	$3p^2(^3P)4s \ ^2P_{1/2}$	41566	1257730		9.5-2	1.9+11	D	72°, 107*
81.943	$5/2$	$3/2$	46075	1266360		9.7-2	1.4+11	D	41, 72°, 107*
81.651	$3/2$	$3/2$	41566	1266360		1.0-2	1.0+10	E	41, 72°, 107*
80.5	$3p^3 \ ^2D_{5/2}$	$3p^2(^1D)4s \ ^2D_{5/2}$	46075	1287700		8.5-2	8.7+10	D	72°, 107*
80.160	$3/2$	$3/2$	41566	1289060		5.8-2	6.0+10	D	72°, 107*
80.5	$3p^3 \ ^4S_{3/2}$	$3p^2(^3P)4s \ ^4P_{1/2}$	0	1242000		3.5-2	7.2+10	D	72°, 107*, 152
80.022	$3/2$	$3/2$	0	1249660		6.5-2	6.8+10	D	72°, 107*, 152
79.488	$3/2$	$5/2$	0	1258050		9.5-2	6.7+10	D	72°, 107*, 152
68.382	$3p^3 \ ^2P_{1/2}$	$3p^2(^3P)4d \ ^2D_{3/2}$	74109	1536480		2.4-1	1.7+11	D	72°, 107*
67.972	$3p^3 \ ^2P_{3/2}$	$3p^2(^1D)4d \ ^2D_{5/2}$	80515	1551640					72
67.821	$3p^3 \ ^2D_{3/2}$	$3p^2(^3P)4d \ ^2F_{5/2}$	41566	1516030		1.4-1	1.4+11	D	72°, 107*
67.702	$5/2$	$7/2$	46075	1523140					72
67.291	$3p^3 \ ^2D_{5/2}$	$3p^2(^3P)4d \ ^4D_{7/2}$	46075	1532160					72
67.164	$3p^3 \ ^2P_{3/2}$	$3p^2(^1D)4d \ ^2S_{1/2}$	80515	1569410		3.8-2	1.1+11	D	72°, 107*

Fe II (P Sequence) Ionization Energy = 2668000 cm⁻¹ (330.8 eV) — Continued

λ (Å)	Classification	Energy Levels (cm ⁻¹)	Int.	f /Type	A (s ⁻¹)	Acc.	References
66.960	$3p^3 \ ^2D_{3/2}$	$3p^2(^3P)4d \ ^2D_{5/2}$	41566 1534990	1.6-1	1.6+11	D	72°, 107*
66.526	$3p^3 \ ^2D_{5/2}$	$3p^2(^1D)4d \ ^2F_{7/2}$	46075 1549250	1.5-1	1.7+11	D	72°, 107*
66.43	$5/2$	$5/2$	46075 1551400				72
66.297	$3p^3 \ ^4S_{3/2}$	$3p^2(^3P)4d \ ^4P_{5/2}$	0 1508360				72
65.905	$3/2$	$3/2$	0 1517340	1.3-1	2.0+11	D	72°, 107*
66.225	$3p^3 \ ^2D_{3/2}$	$3p^2(^1D)4d \ ^2D_{5/2}$	41566 1551640				72
66.047	$3p^3 \ ^4S_{3/2}$	$3p^2(^3P)4d \ ^4F_{5/2}$	0 1514070				72
65.805	$3p^3 \ ^2D_{5/2}$	$3p^2(^1D)4d \ ^2P_{3/2}$	46075 1565720	2.2-2	5.1+10	D	72°, 107*

Fe XIII (Si Sequence) Ionization Energy = 2912000 cm⁻¹ (361.0 eV)

λ (Å)	Classification		Energy Levels (cm ⁻¹)		Int.	f /Type	A (s ⁻¹)	Acc.	References
10797.9	$3s^23p^2\ ^3P_1$	$3s^23p^2\ ^3P_2$	9302.5	18561.0		M1	9.87	C	56, 125°, 135*
10746.8	0	1	0	9302.5		M1	1.40+1	C	56, 125°, 135*
3388.5	$3s^23p^2\ ^3P_2$	$3s^23p^2\ ^1D_2$	18561.0	48068		M1	5.75+1	C	56, 70, 125°, 135*
2578.77	1	2	9302.5	48068		M1	4.57+1	C	135*, 172°
1216.43	$3s^23p^2\ ^3P_1$	$3s^23p^2\ ^1S_0$	9302.5	91508		M1	1.01+3	C	49, 70, 111, 128, 135*, 172°
510.99°	$3s^23p^2\ ^1S_0$	$3s3p^3\ ^3D_1^o$	91508	287205		3.3-4	2.8+6	E	107
510.12	$3s^23p^2\ ^3P_1$	$3s3p^3\ ^5S_2^o$	18561.0	214608					188, 189°
487.08	$3s^23p^2\ ^3P_1$	$3s3p^3\ ^5S_2^o$	9302.5	214608					42°, 188, 189
419.92°	$3s^23p^2\ ^1S_0$	$3s3p^3\ ^3P_1^o$	91508	329647		1.9-3	2.4+7	D	107
418.17°	$3s^23p^2\ ^1D_2$	$3s3p^3\ ^3D_1^o$	48068	287205		5.1-4	3.2+7	E	107
417.90°	2	2	48068	287360		2.8-4	1.1+7	E	107
412.98°	2	3	48068	290210		3.2-3	9.0+7	D	107
372.240°	$3s^23p^2\ ^3P_2$	$3s3p^3\ ^3D_1^o$	18561.0	287205		1.4-4	1.1+7	E	107
372.03°	2	2	18561.0	287360		1.0-3	4.8+7	D	107
368.12	2	3	18561.0	290210		3.6-2	1.3+9	D	70°, 107*, 195
359.837	1	1	9302.5	287205	4	6.8-3	3.5+8	D	4°A, 107*, 195
359.63	1	2	9302.5	287360		5.0-2	1.5+9	D	70°, 107*, 195
348.184	0	1	0	287205	20	7.0-2	1.0+9	E	4°A, 107*, 195
355.14°	$3s^23p^2\ ^1D_2$	$3s3p^3\ ^3P_1^o$	48068	329647		6.0-4	5.3+7	E	107
354.34°	2	2	48068	330279		1.0-4	5.4+6	E	107
321.455°	$3s^23p^2\ ^3P_2$	$3s3p^3\ ^3P_1^o$	18561.0	329647		9.6-3	1.0+9	D	107
320.800	2	2	18561.0	330279	7	5.2-2	3.4+9	D	4°A, 70, 107*
312.164	1	1	9302.5	329647	8	2.9-2	2.0+9	D	4°A, 24, 107*
311.552	1	2	9302.5	330279	2	1.2-2	4.8+8	D	4°A, 107*
303.355°	0	1	0	329647		5.7-2	1.4+9	D	107
318.21	$3s^23p^2\ ^1D_2$	$3s3p^3\ ^1D_2^o$	48068	362330		8.0-2	5.3+9	E	70°, 107*
308.69°	$3s^23p^2\ ^1S_0$	$3s3p^3\ ^3S_1^o$	91508	415462		1.7-2	3.9+8	D	107
290.89°	$3s^23p^2\ ^3P_2$	$3s3p^3\ ^1D_2^o$	18561.0	362330		1.6-3	1.3+8	E	107
283.26°	1	2	9302.5	362330		1.4-3	7.0+7	E	107
288.57°	$3s^23p^2\ ^1S_0$	$3s3p^3\ ^1P_1^o$	91508	438050		1.5-1	4.0+9	D	107
272.19°	$3s^23p^2\ ^1D_2$	$3s3p^3\ ^3S_1^o$	48068	415462		4.0-3	6.0+8	D	107
256.42	$3s^23p^2\ ^1D_2$	$3s3p^3\ ^1P_1^o$	48068	438050		1.8-1	3.0+10	D	41, 68°, 107*
251.953	$3s^23p^2\ ^3P_2$	$3s3p^3\ ^3S_1^o$	18561.0	415462	40	2.0-1	3.5+10	D	4°A, 41, 68, 107*, 152, 195
246.208	1	1	9302.5	415462	20	1.6-1	1.8+10	D	4°A, 68, 107*, 152, 195
240.713	0	1	0	415462	20	1.8-1	6.9+9	D	4°A, 41, 68, 107*, 152, 195
247.87°	$3s^23p^2\ ^1S_0$	$3s^23p3d\ ^3P_1^o$	91508	494942		2.4-3	8.9+7	E	107
240.97°	$3s^23p^2\ ^1S_0$	$3s^23p3d\ ^3D_1^o$	91508	506502		4.4-4	1.7+7	E	107
238.39°	$3s^23p^2\ ^3P_2$	$3s3p^3\ ^1P_1^o$	18561.0	438050		4.8-3	9.5+8	D	107
233.234	1	1	9302.5	438050		4.3-2	5.3+9	D	4°, 24, 107*
228.28°	0	1	0	438050		1.7-2	7.4+8	D	107
223.78°	$3s^23p^2\ ^1D_2$	$3s^23p3d\ ^3P_1^o$	48068	494942		3.3-3	7.2+8	E	107
221.822	$3s^23p^2\ ^1D_2$	$3s^23p3d\ ^1D_2^o$	48068	498870	15				4°A, 24, 70
218.13°	$3s^23p^2\ ^1D_2$	$3s^23p3d\ ^3D_1^o$	48068	506502		5.0-3	1.2+9	E	107

Fe XIII (Si Sequence) Ionization Energy = 2912000 cm⁻¹ (361.0 eV) — Continued

λ (Å)	Classification		Energy Levels (cm ⁻¹)		Int.	f /Type	A (s ⁻¹)	Acc.	References
216.88	2	3	48068	509176		2.4-2	2.4+9	D	107*, 195°
216.88	2	2	48068	509250		6.8-2	9.6+9	D	107*, 195°
213.770	$3s^2 3p^2 \ ^3P_2$	$3s^2 3p 3d \ ^3P_2^o$	18561.0	486358	7				4 ^Δ , 70
209.916	2	1	18561.0	494942	15	2.4-2	6.1+9	E	4 ^Δ , 107*
209.617	1	2	9302.5	486358	6				4 ^Δ , 70
205.91 ^c	1	1	9302.5	494942		1.0-4	1.6+7	E	107
202.424	1	0	9302.5	503340	7	1.0-1	4.9+10	D	4 ^Δ , 24, 107*
202.044	0	1	0	494942	65	9.7-1	5.3+10	E	4 ^Δ , 70, 107*
208.679	$3s^2 3p^2 \ ^1S_0$	$3s^2 3p 3d \ ^1P_1^o$	91508	570690		1.2	6.1+10	D	4°, 24, 70, 107*
204.942	$3s^2 3p^2 \ ^3P_2$	$3s^2 3p 3d \ ^3D_1^o$	18561.0	506502	5	6.0-2	1.6+10	E	4 ^Δ , 107*, 152, 195
203.826	2	3	18561.0	509176	20	5.9-1	6.8+10	D	3, 4 ^Δ , 24, 64, 67, 107*, 152, 195
203.793	2	2	18561.0	509250	8	2.3-1	3.7+10	D	4 ^Δ , 70, 107*, 152, 195
201.121	1	1	9302.5	506502	15	2.5-1	4.1+10	E	4 ^Δ , 70, 107*, 152, 195
200.021	1	2	9302.5	509250	5	1.9-1	1.9+10	D	4 ^Δ , 70, 107*, 152, 195
197.434	0	1	0	506502	2	8.0-2	5.0+9	E	4 ^Δ , 107*, 152, 195
204.263	$3s^2 3p^2 \ ^3P_1$	$3s^2 3p 3d \ ^1D_2^o$	9302.5	498870					4°, 24, 70
196.525	$3s^2 3p^2 \ ^1D_2$	$3s^2 3p 3d \ ^1F_3^o$	48068	556870	4	5.8-1	7.2+10	D	3, 4 ^Δ , 24, 64, 67, 70, 107*, 152
191.24	$3s^2 3p^2 \ ^1D_2$	$3s^2 3p 3d \ ^1P_1^o$	48068	570690		2.7-6	8.3+5	E	70°, 107*
185.77 ^c	$3s^2 3p^2 \ ^3P_2$	$3s^2 3p 3d \ ^1F_3^o$	18561.0	556870		2.3-2	3.2+9	D	107
181.12 ^c	$3s^2 3p^2 \ ^3P_2$	$3s^2 3p 3d \ ^1P_1^o$	18561.0	570690		3.4-5	1.1+7	E	107
178.13 ^c	1	1	9302.5	570690		8.5-4	1.8+8	E	107
175.23 ^c	0	1	0	570690		5.9-3	4.3+8	D	107
107.384	$3s^2 3p 3d \ ^1F_3^o$	$3s^2 3p 4p \ ^1D_2$	556870	1488110		2.2-1	1.8+11	D	72°, 107*
98.826	$3s^2 3p 3d \ ^3F_2^o$	$3s^2 3p 4p \ ^3D_1$				3.4-2	3.9+10	E	72°, 107*
98.523	3	2				4.0-2	3.8+10	D	72°, 107*
98.128	4	3				4.6-2	4.1+10	D	72°, 107*
98.387	$3s^2 3p 3d \ ^1D_2^o$	$3s^2 3p 4p \ ^1P_1$	498870	1515260					72
85.461	$3s^2 3p 3d \ ^1P_1^o$	$3s^2 3p 4f \ ^1D_2$	570690	1740800		6.2-1	3.4+11	D	107*, 134°
84.275	$3s^2 3p 3d \ ^1F_3^o$	$3s^2 3p 4f \ ^1G_4$	556870	1743460		7.7-1	5.6+11	D	72°, 107*, 134
82.010	$3s^2 3p 3d \ ^3D_2^o$	$3s^2 3p 4f \ ^3F_3$	509250	1728600?					134
81.161	3	4	509176	1741290		4.8-1	3.7+11	E	72°, 107*
81.154	$3s^2 3p 3d \ ^3P_0^o$	$3s^2 3p 4f \ ^3D_1$	503340	1735600?		6.8-1	2.3+11	D	107*, 134°
78.77	$3s^2 3p 3d \ ^3F_3^o$	$3s^2 3p 4f \ ^3G_4$				5.0-1	4.1+11	E	72°, 107*, 134
78.56	2	3							72
78.462	4	5				7.3-1	6.5+11	D	72°, 107*, 134
76.117	$3s^2 3p^2 \ ^1D_2$	$3s^2 3p 4s \ ^1P_1^o$	48068	1361830		1.1-1	2.1+11	D	72°, 107*
75.892	$3s^2 3p^2 \ ^3P_2$	$3s^2 3p 4s \ ^3P_1^o$	18561.0	1336220		4.0-2	7.7+10	D	72°, 107*, 152
74.845	2	2	18561.0	1354680		8.8-2	1.0+11	D	72°, 107*, 152
74.327	1	2	9302.5	1354680		5.7-2	4.1+10	D	72°, 107*
64.139	$3s^2 3p^2 \ ^1S_0$	$3s^2 3p 4d \ ^1P_1^o$	91508	1650620		3.9-1	2.1+11	D	107*, 134°
63.188	$3s^2 3p^2 \ ^1D_2$	$3s^2 3p 4d \ ^1F_3^o$	48068	1630650		3.3-1	3.9+11	D	72, 107*, 134°
62.963	$3s^2 3p^2 \ ^3P_2$	$3s^2 3p 4d \ ^3D_3^o$	18561.0	1606800					72, 134°
62.699	1	2	9302.5	1604220		2.3-1	2.3+11	D	72, 107*, 134°
62.353	0	1	0	1603770		3.5-1	2.0+11	D	107*, 134°
62.46	$3s^2 3p^2 \ ^3P_2$	$3s^2 3p 4d \ ^3F_3^o$	18561.0	1619600		9.8-2	1.2+11	D	107*, 134°
62.10	$3s^2 3p^2 \ ^3P_1$	$3s^2 3p 4d \ ^3P_0^o$	9302.5	1620000		3.1-2	1.6+11	D	107*, 134°

Fe XIV (Al Sequence) Ionization Energy = 3163000 cm⁻¹ (392.2 eV)

λ (Å)	Classification		Energy Levels (cm ⁻¹)		Int.	f /Type	A (s ⁻¹)	Acc.	References			
5302.86	$3s^2 3p^2 2P_{1/2}^o$	$3s^2 3p^2 2P_{3/2}^o$	0	18852.5		M1	6.02+1	C	56°, 125, 135*			
1097.82 ^c	$3s^2 4d^2 2D_{5/2}$	$3s^2 4f^2 2F_{7/2}^o$	1697290	1788380		1.7-1	7.1+8	D	107			
1094.69 ^c			$5/2$	$5/2$	1697290	1788640	8.4-3	4.7+7	D	107		
1079.21 ^c			$3/2$	$5/2$	1695980	1788640	1.8-1	6.9+8	D	107		
819.874 ^c	$3s^2 4p^2 2P_{3/2}^o$	$3s^2 4d^2 2D_{3/2}$	1574010	1695980		6.3-2	6.3+8	D	107			
811.162 ^c			$3/2$	$5/2$	1574010	1697290	5.7-1	3.9+9	D	107		
786.535 ^c			$1/2$	$3/2$	1568840	1695980	6.5-1	3.5+9	D	107		
747.272 ^c	$3s^2 4s^2 2S_{1/2}$	$3s^2 4p^2 2P_{1/2}^o$	1435020	1568840		2.2-1	2.6+9	D	107			
719.476 ^c			$1/2$	$3/2$	1435020	1574010	4.6-1	3.0+9	D	107		
484.60	$3s^2 3p^2 2P_{3/2}^o$	$3s^2 3p^2 4P_{1/2}$	18852.5	225095					188, 189°			
467.40			$3/2$	$3/2$	18852.5	232805				42°, 188, 189		
447.36			$3/2$	$5/2$	18852.5	242401				42°, 188, 189		
444.25			$1/2$	$1/2$	0	225095				42°, 188, 189		
356.60	$3s^2 3p^2 2P_{3/2}^o$	$3s^2 3p^2 2D_{3/2}$	18852.5	299248		1.2-3	6.3+7	D	70°, 107*, 195			
353.833			$3/2$	$5/2$	18852.5	301472	9	5.4-2	1.9+9	D	4° ^A , 68, 70, 107*, 195	
334.171			$1/2$	$3/2$	0	299248	30	7.9-2	2.4+9	D	4° ^A , 41, 70, 107*, 195	
289.160	$3s^2 3p^2 2P_{3/2}^o$	$3s^2 3p^2 2S_{1/2}$	18852.5	364693	4	6.9-3	1.1+9	E	4° ^A , 41, 70, 107*, 152, 195			
274.203			$1/2$	$1/2$	0	364693	55	2.4-1	2.1+10	C	3, 4° ^A , 65, 107*, 152, 195	
288.45	$3s^2 3p^2 4P_{5/2}$	$3p^3 4S_{3/2}^o$	242401	589080		1.4-1	1.7+10	D	68°, 107*			
280.69			$3/2$	$3/2$	232805	589080	1.5-1	1.3+10	D	68°, 107*		
274.74 ^c			$1/2$	$3/2$	225095	589080	1.5-1	6.6+9	D	108		
270.524	$3s^2 3p^2 2P_{3/2}^o$	$3s^2 3p^2 2P_{1/2}$	18852.5	388510	35	1.4-1	2.6+10	D	3, 4° ^A , 41, 65, 68, 107*, 127, 152			
264.787			$3/2$	$3/2$	18852.5	396515	50	4.5-1	4.3+10	D	3, 4° ^A , 41, 65, 107*, 127, 152	
257.392			$1/2$	$1/2$	0	388510	15	1.8-1	1.8+10	D	3, 4° ^A , 41, 65, 107*, 127, 152	
252.197			$1/2$	$3/2$	0	396515	10	2.1-1	1.1+10	D	3, 4° ^A , 41, 65, 107*, 127, 152	
220.082	$3s^2 3p^2 2P_{3/2}^o$	$3s^2 3d^2 2D_{3/2}$	18852.5	473227	20	6.0-2	8.3+9	C	3, 4° ^A , 64, 107*, 127, 152, 201			
219.123			$3/2$	$5/2$	18852.5	475217	15	4.5-1	4.2+10	C	3, 4° ^A , 64, 107*, 110, 127, 152	
211.316			$1/2$	$3/2$	0	473227	45	5.0-1	3.7+10	C	3, 4° ^A , 64, 107*, 110, 127, 152, 201	
218.21	$3s^2 3p^2 4P_{5/2}$	$3s^2 3p^2 4D_{5/2}^o$	242401	700675		4.1-1	4.3+9	D	70°, 107*			
91.273			$3s^2 3d^2 2D_{3/2}$	$3s^2 4p^2 2P_{1/2}^o$	473227	1568840		2.3-2	3.7+10	C	72°, 107*	
91.009					$5/2$	$3/2$	475217	1574010	2.8-2	3.4+10	C	72°, 107*
90.844 ^c					$3/2$	$3/2$	473227	1574010	4.7-3	3.8+9	D	107
78.766 ^c	$3s^2 3p^2 2D_{3/2}$	$3s^2 4p^2 2P_{1/2}^o$	299248	1568840		1.5-2	3.3+10	C	107			
78.583 ^c			$5/2$	$3/2$	301472	1574010	1.8-2	2.9+10	C	107		
78.446 ^c			$3/2$	$3/2$	299248	1574010	3.0-3	3.3+9	D	107		
76.152	$3s^2 3d^2 2D_{5/2}$	$3s^2 4f^2 2F_{7/2}^o$	475217	1788380		8.1-1	7.0+11	C	72°, 107*			
76.137 ^c			$5/2$	$5/2$	475217	1788640	3.4-2	3.9+10	E	107		
76.022			$3/2$	$5/2$	473227	1788640	8.6-1	6.6+11	C	72°, 107*		
73.08	$3s^2 3p^2 4F_{7/2}^o$	$3s^2 3p^2 4G_{9/2}$				5.0-1	5.0+11	D	72°, 107*			
72.95			$5/2$	$7/2$			5.4-1	5.1+11	D	72°, 107*		
72.80			$9/2$	$11/2$			7.5-1	7.9+11	D	72°, 107*		
71.377	$3s^2 3p^2 2D_{5/2}$	$3s^2 3p^2 4S_{3/2}^o$	301472	1702500					72			
70.613	$3s^2 3p^2 2P_{3/2}^o$	$3s^2 4s^2 2S_{1/2}$	18852.5	1435020		6.1-2	1.6+11	C	72°, 107*, 194, 201			
69.66			$1/2$	$1/2$	0	1435020	6.3-2	8.7+10	C	72°, 107*, 194, 201		

Fe xiv (Al Sequence) Ionization Energy = 3163000 cm⁻¹ (392.2 eV) — Continued

λ (Å)	Classification		Energy Levels (cm ⁻¹)		Int.	f /Type	A (s ⁻¹)	Acc.	References
70.251	$3s3p^2\ ^4P_{5/2}$	$3s3p(^8P^o)4s\ ^4P_{3/2}^o$	242401	1666100		4.0-2	8.1+10	D	72°, 107*
69.667	$5/2$	$5/2$	242401	1678400		9.2-2	1.3+11	D	72°, 107*
69.386	$1/2$	$3/2$	225095	1666100		1.1-1	7.6+10	D	72°, 107*
69.176	$3/2$	$5/2$	232805	1678400		6.0-2	5.6+10	D	72°, 107*
59.626 ^c	$3s^23p\ ^2P_{3/2}^o$	$3s^24d\ ^2D_{3/2}^o$	18852.5	1695980		2.8-2	5.3+10	C	107
59.579	$3/2$	$5/2$	18852.5	1697290	3	2.5-1	3.2+11	C	53 ^a , 67, 107*, 194, 201
58.963	$1/2$	$3/2$	0	1695980	2	2.8-1	2.7+11	C	53 ^a , 67, 107*, 152, 194, 201

Fe xv (Mg Sequence) Ionization Energy = 3686000 cm⁻¹ (457 eV)

λ (Å)	Classification		Energy Levels (cm ⁻¹)		Int.	f /Type	A (s ⁻¹)	Acc.	References
7058.6	$3s3p\ ^3P_1^o$	$3s3p\ ^3P_2^o$	239660	253820		M1	3.74+1	C	125°, 135*
536.418	$3s3d\ ^1D_2$	$3p3d\ ^1D_2^o$	762093	948513	330				34
493.552 ^c	$3s3p\ ^1P_1^o$	$3p^2\ ^3P_0$	351911	554524		7.8-4	6.4+7	D	107
470.166 ^c	1	1	351911	564602		2.8-4	8.4+6	D	107
434.98	1	2	351911	581803	2	2.2-2	4.7+8	D	107*, 149 ^a
481.493	$3s3p\ ^1P_1^o$	$3p^2\ ^1D_2$	351911	559600	260	8.96-2	1.55+9	C+	34 ^a , 40, 51, 68, 71, 107*
417.258	$3s^2\ ^1S_0$	$3s3p\ ^3P_1^o$	0	239660		3.2-3	4.1+7	D	4°, 34, 40, 51, 102, 107*, 127, 165
402.48	$3s3d\ ^3D_2$	$3p3d\ ^3F_2^o$	679785	928241	1				149
400.851	1	2	678772	928241	190				34 ^a , 68
389.54	3	3	681416	938126	1				149
387.086	2	3	679785	938126	280				34 ^a , 68
372.798	3	4	681416	949658	440				34 ^a , 68
332.854	$3s3d\ ^1D_2$	$3p3d\ ^1F_3^o$	762093	1062515	370	3.78-1	1.63+10	C	34 ^a , 108*
331.083	$3s3d\ ^3D_3$	$3p3d\ ^3P_2^o$	681416	983514	170				34
314.99	1	1	678772	996243	3				149
329.94	$3s3d\ ^3D_2$	$3p3d\ ^3D_1^o$	679785	982868	4				149
319.047	3	3	681416	994852	180				34
315.559	2	2	679785	996623	120				34
327.024	$3s3p\ ^3P_2^o$	$3p^2\ ^1D_2$	253820	559600	200	3.2-2	2.0+9	C	34 ^a , 40, 107*
312.556	1	2	239660	559600	70	2.7-2	1.1+9	D	34 ^a , 40, 107*
324.975	$3s3p\ ^1P_1^o$	$3p^2\ ^1S_0$	351911	659627	180	1.05-1	2.02+10	C	34 ^a , 40, 107*
321.771	$3s3p\ ^3P_2^o$	$3p^2\ ^3P_1$	253820	564602	310	6.63-2	7.11+9	C+	34 ^a , 40, 41, 65, 107*
317.597	1	0	239660	554524	220	8.93-2	1.77+10	C+	34 ^a , 65, 70, 107*
307.730	1	1	239660	564602	220	6.97-2	4.91+9	C+	34 ^a , 40, 70, 107*
304.894	2	2	253820	581803	400	1.77-1	1.27+10	C+	34 ^a , 65, 70, 107*
302.334	0	1	233842	564602	140	2.85-1	6.93+9	C+	34 ^a , 70, 107*
292.275	1	2	239660	581803	220	9.52-2	4.46+9	C+	34 ^a , 70, 107*
319.70	$3s3d\ ^1D_2$	$3p3d\ ^1P_1^o$	762093	1074887	4				149
305.940 ^c	$3s3p\ ^1P_1^o$	$3s3d\ ^3D_1$	351911	678772		3.3-4	2.4+7	D	107
304.995 ^c	1	2	351911	679785		3.2-4	1.4+7	D	107

Fe XV (Mg Sequence) Ionization Energy = 3686000 cm⁻¹ (457 eV) — Continued

λ (Å)	Classification		Energy Levels (cm ⁻¹) Int.			f /Type	A (s ⁻¹)	Acc.	References
284.164	3s ² 1S ₀	3s3p 1P ₁ ^o	0	351911	1000	8.0-1	2.2+10	C	3, 34 ^{c,d} , 40, 41, 64, 102, 107*, 127, 152, 164, 165
272.70	3p ² 3P ₂	3p3d 1D ₂ ^o	581803	948513	1				149
271.27	3p ² 1D ₂	3p3d 3F ₂ ^o	559600	928241	2				149
257.127	3p ² 1D ₂	3p3d 1D ₂ ^o	559600	948513	210				34
243.794	3s3p 1P ₁ ^o	3s3d 1D ₂	351911	762093	390	6.23-1	4.19+10	C+	34 ^a , 40, 71, 107*, 164
242.100	3p ² 3P ₂	3p3d 3D ₃ ^o	581803	994852	200				34
241.066			581803	996623	100				34
233.46			554524	982868	2				149
231.47			564602	996623	2				149
240.81	3p ² 1S ₀	3p3d 1P ₁ ^o	659627	1074887	3				149
238.708	3p ² 3P ₁	3p3d 3P ₂ ^o	564602	983514	140				34
231.87			564602	995889	2				149
231.68			564602	996243	2				34, 149 ^a
235.32 ^c	3s3p 3P ₂ ^o	3s3d 3D ₁	253820	678772		3.1-3	6.2+8	D	107
234.782			253820	679785	60	4.50-2	5.45+9	C+	34 ^a , 40, 107*
233.865			253820	681416	290	2.74-1	2.39+10	C	3, 34 ^a , 40, 41, 64, 107*, 127, 152, 164, 201
227.734			239660	678772	140	7.69-2	9.90+9	C+	34 ^a , 64, 107*, 164
227.206			239660	679785	220	2.33-1	1.80+10	C+	3, 34 ^a , 40, 41, 64, 107*, 164
224.754			233842	678772	90	3.14-1	1.38+10	C+	3, 34 ^a , 40, 64, 107*, 164
229.744	3p ² 1D ₂	3p3d 3D ₃ ^o	559600	994852	60				34
208.034	3p ² 3P ₂	3p3d 1F ₃ ^o	581803	1062515	60				34
198.867	3p ² 1D ₂	3p3d 1F ₃ ^o	559600	1062515		2.32-1	2.79+10	C	34 ^a , 107*
196.74 ^c	3s3p 3P ₂ ^o	3s3d 1D ₂	253820	762093		6.5-5	1.1+7	D-	107
191.41 ^c			239660	762093		2.8-3	3.0+8	D	107
73.473	3s3d 1D ₂	3s4f 1F ₃ ^o	762093	2123150		6.9-1	6.1+11	C	40 ^a , 72, 107*, 152
73.471	3p3d 1P ₁ ^o	3p4f 1D ₂	1074887	2436000		9.4-1	7.0+11	C	107*, 134 ^a
73.199	3p3d 1F ₃ ^o	3p4f 1G ₄	1062515	2428700		9.1-1	8.8+11	C	107*, 134 ^a
71.267	3p3d 3P ₂ ^o	3p4f 1F ₃	983514	2386700					134
71.062	3p3d 3D ₃ ^o	3p4f 3F ₄	994852	2402100		5.1-1	5.2+11	D	72, 107*, 134 ^a
71.062			982868	2390100		8.1-1	6.4+11	C	72, 107*, 134 ^a
70.601	3p3d 3D ₂ ^o	3p4f 3D ₃	996623	2413000		4.7-1	4.5+11	D	72, 107*, 134 ^a
70.519	3p3d 3P ₁ ^o	3p4f 3D ₂	996243	2414300		5.5-1	4.4+11	C	72, 107*, 134 ^a
70.224			995889	2420100		9.1-1	4.1+11	C	72, 107*, 134 ^a
70.224			996243	2420100		3.1-1	4.2+11	C	72, 107*, 134 ^a
70.054	3s3d 3D ₃	3s4f 3F ₄ ^o	681416	2108880	4	8.3-1	8.8+11	C	40, 53 ^a , 63, 72, 107*, 134, 152
69.987			679785	2108620	3	8.1-1	7.9+11	C	40, 53 ^a , 72, 107*, 134
69.945			678772	2108520	2	9.1-1	7.4+11	C	40, 53 ^a , 107*, 134
69.66	3s3p 1P ₁ ^o	3s4s 1S ₀	351911	1787000		4.7-2	1.9+11	D	40 ^a , 107*
69.534	3p3d 1D ₂ ^o	3p4f 1F ₃	948513	2386700					72, 134 ^a

Fe xv (Mg Sequence) Ionization Energy = 3686000 cm⁻¹ (457 eV) — Continued

λ (Å)	Classification	Energy Levels (cm ⁻¹)	Int.	f /Type	A (s ⁻¹)	Acc.	References		
69.036	$3p3d\ ^3F_3^o$	$3p4f\ ^3G_4$	938126	2386700	6.0-1	6.5+11	D	72 ^a , 107*, 134	
68.883	2	3	928241	2380160				72 ^a , 134	
68.849	4	5	949658	2402100	8.0-1	9.2+11	C	72 ^a , 107*, 134	
66.238	$3s3p\ ^3P_2^o$	$3s4s\ ^3S_1$	253820	1763700	1	6.2-2	1.6+11	D	94 ^a , 107*
65.612	1	1	239660	1763700	1	6.3-2	9.8+10	D	63, 94 ^a , 107*
65.370	0	1	233842	1763700	0	6.2-2	3.2+10	D	40, 63, 94 ^a , 107*
63.96	$3p^2\ ^1D_2$	$3s4f\ ^1F_3^o$	559600	2123150	2.0-1	2.3+11	D	40 ^a , 71, 107*	
59.404	$3s3p\ ^1P_1^o$	$3s4d\ ^1D_2$	351911	2035280	3.0-1	3.4+11	C	40, 72 ^a , 107*	
56.236	$3s3p\ ^3P_2^o$	$3s4d\ ^3D_2$	253820	2032020	0			53	
56.200	2	3	253820	2033180	3			53 ^a , 63	
55.815	1	1	239660	2031310	0			53	
55.793	1	2	239660	2032020	2			53 ^a , 63	
55.635	0	1	233842	2031310	1			53 ^a , 63	
52.911	$3s^2\ ^1S_0$	$3s4p\ ^1P_1^o$	0	1889970	3	3.70-1	2.94+11	C	40, 53 ^a , 63, 107*, 152, 194
50.120	$3s3d\ ^3D_3$	$3s5f\ ^3F_4^o$	681416	2676600	1			53 ^a , 63	
50.085	2	3	679785	2676400	0			53	
50.062	1	2	678772	2676400	0			53	
49.49	$3s3d\ ^1D_2$	$3s5f\ ^1F_3^o$	762093	2782700?				63	
43.65	$3s3p\ ^3P_2^o$	$3s5s\ ^3S_1$	253820	2544800				63	
43.39	$3s3d\ ^3D_3$	$3s6f\ ^3F_4^o$	681416	2986100				63	
42.93	$3s3d\ ^1D_2$	$3s6f\ ^1F_3^o$	762093	3091500?				63	
41.903	$3s3p\ ^3P_2^o$	$3s5d\ ^3D_3$	253820	2640300	4			94	
41.663	1	2	239660	2639900	3			94	
41.559	0	1	233842	2640100	1			94	
38.95	$3s^2\ ^1S_0$	$3s5p\ ^1P_1^o$	0	2567000	1.15-1	1.69+11	C	63 ^a , 107*	
17.917	$3s3p\ ^1P_1^o$	$2p^53s^23p\ ^1P_1$	351911	5933200?	7			30	
17.880	$3s3p\ ^1P_1^o$	$2p^53s^23p\ ^3P_2$	351911	5947500?	10			30	
17.620	$3s3p\ ^3P_2^o$	$2p^53s^23p\ ^3D_3$	253820	5929200?	20			30	
17.593	$3s3p\ ^1P_1^o$	$2p^53s^23p\ ^3D_2$	351911	6036000?	20			30	
17.555	$3s3p\ ^3P_2^o$	$2p^53s^23p\ ^3P_2$	253820	5947500?	7			30	
17.300	2	1	253820	6034200?	5			30	

Fe XVI (Na Sequence) Ionization Energy = 3946150 cm⁻¹ (489.260 eV)

λ (Å)	Classification	Energy Levels (cm ⁻¹)	Int.	f /Type	A (s ⁻¹)	Acc.	References	
1812. ^c	$2p^6 5s^2 S_{1/2}$	$2p^6 5p^2 P_{1/2}^o$	2662000	2717170	2.3-1	4.6+8	D 107	
1690. ^c	$1/2$	$3/2$	2662000	2721160	4.8-1	5.6+8	C 107	
1673.9 ^c	$2p^6 4d^2 D_{5/2}$	$2p^6 4f^2 F_{5/2}^o$	2125360	2185100	5.2-3	1.2+7	D 107	
1660.0 ^c	$5/2$	$7/2$	2125360	2185600	1.04-1	1.86+8	B 107	
1641.8 ^c	$3/2$	$5/2$	2124190	2185100	1.11-1	1.81+8	B 107	
1494.99 ^c	$2p^6 5p^2 P_{3/2}^o$	$2p^6 5d^2 D_{3/2}$	2721160	2788050	5.6-2	1.7+8	D 107	
1482.58 ^c	$3/2$	$5/2$	2721160	2788610	5.20-1	1.05+9	C 107	
1410.84 ^c	$1/2$	$3/2$	2717170	2788050	6.00-1	1.00+9	C 107	
904.977 ^c	$2p^6 4s^2 S_{1/2}$	$2p^6 4p^2 P_{1/2}^o$	1867540	1978040	1.82-1	1.48+9	B 107	
843.45 ^c	$1/2$	$3/2$	1867540	1986100	3.93-1	1.84+9	B 107	
724.17 ^c	$2p^6 4p^2 P_{3/2}^o$	$2p^6 4d^2 D_{3/2}$	1986100	2124190	4.41-2	5.60+8	B 107	
718.08 ^c	$3/2$	$5/2$	1986100	2125360	4.02-1	3.47+9	B 107	
684.229 ^c	$1/2$	$3/2$	1978040	2124190	4.66-1	3.31+9	B 107	
360.758	$2p^6 3s^2 S_{1/2}$	$2p^6 3p^2 P_{1/2}^o$	0	277192	1	1.25-1	6.41+9	B 3, 4, 94 ^A , 107*, 164, 165, 169 ^o
335.409	$1/2$	$3/2$	0	298143	2	2.72-1	8.06+9	B 3, 4, 94 ^A , 107*, 164, 165, 169 ^o
267.008 ^c	$2p^6 5d^2 D_{5/2}$	$2p^6 6f^2 F_{5/2}^o$	2788610	3163130	3.0-2	2.8+9	D 107	
266.966 ^c	$5/2$	$7/2$	2788610	3163190	6.10-1	4.31+10	C 107	
266.610 ^c	$3/2$	$5/2$	2788050	3163130	6.50-1	4.04+10	C 107	
265.003	$2p^6 3p^2 P_{3/2}^o$	$2p^6 3d^2 D_{3/2}$	298143	675481	1	2.79-2	2.65+9	B 94 ^A , 107*, 164, 169 ^o
262.976	$3/2$	$5/2$	298143	678394	6	2.54-1	1.63+10	B 3, 4, 94 ^A , 107*, 152, 164, 169 ^o , 201
251.061	$1/2$	$3/2$	277192	675481	4	2.94-1	1.56+10	B 3, 4 ^o , 64, 94 ^A , 107*, 152, 164, 169 ^o
168.640 ^c	$2p^6 4d^2 D_{3/2}$	$2p^6 5p^2 P_{1/2}^o$	2124190	2717170	7.50-2	3.53+10	C 107	
167.842 ^c	$5/2$	$3/2$	2125360	2721160	9.10-2	3.22+10	C 107	
167.513 ^c	$3/2$	$3/2$	2124190	2721160	1.5-2	3.6+9	D 107	
156.88	$2p^6 4f^2 F_{7/2}^o$	$2p^6 5g^2 G_{9/2}$	2185600	2823000			141, 146 ^o	
156.80	$5/2$	$7/2$	2185100	2822900			141, 146 ^o	
148.0 ^c	$2p^6 4p^2 P_{3/2}^o$	$2p^6 5s^2 S_{1/2}$	1986100	2662000	1.06-1	6.40+10	C 107	
146.2 ^c	$1/2$	$1/2$	1978040	2662000	1.07-1	3.34+10	C 107	
144.25 ^c	$2p^6 4d^2 D_{5/2}$	$2p^6 5f^2 F_{5/2}^o$	2125360	2818600	3.4-2	1.1+10	D 107	
144.25	$5/2$	$7/2$	2125360	2818900	2	6.90-1	1.66+11	C 107*, 146 ^o Δ
144.06	$3/2$	$5/2$	2124190	2818600	2	7.30-1	1.56+11	C 107*, 146 ^o Δ
124.70 ^c	$2p^6 4p^2 P_{3/2}^o$	$2p^6 5d^2 D_{3/2}$	1986100	2788050	2.7-2	1.2+10	D 107	
124.61 ^c	$3/2$	$5/2$	1986100	2788610	2.46-1	7.00+10	C 107	
123.455 ^c	$1/2$	$3/2$	1978040	2788050	2.76-1	6.00+10	C 107	
117.698 ^c	$2p^6 4s^2 S_{1/2}$	$2p^6 5p^2 P_{1/2}^o$	1867540	2717170	8.1-2	3.9+10	D 107	
117.148 ^c	$1/2$	$3/2$	1867540	2721160	1.62-1	3.94+10	C 107	
96.360 ^c	$2p^6 4d^2 D_{5/2}$	$2p^6 6f^2 F_{5/2}^o$	2125360	3163130	8.4-3	6.0+9	D 107	
96.355 ^c	$5/2$	$7/2$	2125360	3163190	1.71-1	9.20+10	C 107	
96.252 ^c	$3/2$	$5/2$	2124190	3163130	1.79-1	8.60+10	C 107	
76.796	$2p^6 3d^2 D_{3/2}$	$2p^6 4p^2 P_{1/2}^o$	675481	1978040	3.40-2	7.69+10	B 72 ^o , 107*	
76.502	$5/2$	$3/2$	678394	1986100	3.91-2	6.68+10	B 72 ^o , 107*	
76.300 ^c	$3/2$	$3/2$	675481	1986100	6.5-3	7.4+9	D 107	
66.370 ^c	$2p^6 3d^2 D_{5/2}$	$2p^6 4f^2 F_{5/2}^o$	678394	2185100	4.41-2	6.67+10	B 107	
66.356	$5/2$	$7/2$	678394	2185600	30	8.82-1	1.00+12	B 1, 3 ^A , 52, 72, 107*, 152, 169 ^o , 194
66.249	$3/2$	$5/2$	675481	2185100	20	9.24-1	9.36+11	B 1, 3 ^A , 52, 72, 107*, 152, 169 ^o

Fe XVI (Na Sequence) Ionization Energy = 3946150 cm⁻¹ (489.260 eV) — Continued

λ (Å)	Classification	Energy Levels (cm ⁻¹)	Int.	f /Type	A (s ⁻¹)	Acc.	References		
63.719	$2p^6 3p^2 P_{3/2}^{\circ}$	$2p^6 4s^2 S_{1/2}$	298143	1867540	30	6.61-2	2.17+11	B	3 ^a , 52°, 63, 72, 107*, 152, 194
62.879	$1/2$	$1/2$	277192	1867540	20	6.22-2	1.05+11	B	3 ^a , 52°, 63, 72, 107*, 152, 194
54.769	$2p^6 3p^2 P_{3/2}^{\circ}$	$2p^6 4d^2 D_{3/2}$	298143	2124190		3.14-2	6.98+10	B	52°, 72, 107*
54.728	$3/2$	$5/2$	298143	2125360		2.80-1	4.16+11	B	52°, 72, 107*, 194
54.142	$1/2$	$3/2$	277192	2124190		3.00-1	3.41+11	B	52°, 72, 107*, 152, 194
50.555	$2p^6 3s^2 S_{1/2}$	$2p^6 4p^2 P_{1/2}^{\circ}$	0	1978040		7.56-2	1.97+11	B	52°, 63, 67, 72, 107*
50.350	$1/2$	$3/2$	0	1986100		1.41-1	1.85+11	B	41, 52°, 63, 67, 72, 107*
48.979 ^c	$2p^6 3d^2 D_{3/2}$	$2p^6 5p^2 P_{1/2}^{\circ}$	675481	2717170		5.1-3	2.8+10	D	107
48.97	$5/2$	$3/2$	678394	2721160		6.2-3	2.6+10	D	63°, 107*
48.884 ^c	$3/2$	$3/2$	675481	2721160		1.0-3	2.9+9	E	107
46.724 ^c	$2p^6 3d^2 D_{5/2}$	$2p^6 5f^2 F_{5/2}^{\circ}$	678394	2818600		8.1-3	2.5+10	D	107
46.718	$5/2$	$7/2$	678394	2818900		1.63-1	3.73+11	C	52°, 63, 107*
46.661	$3/2$	$5/2$	675481	2818600		1.71-1	3.49+11	C	52°, 63, 107*
42.30	$2p^6 3p^2 P_{3/2}^{\circ}$	$2p^6 5s^2 S_{1/2}$	298143	2662000		1.2-2	9.1+10	C	63°, 107*
41.91	$1/2$	$1/2$	277192	2662000		1.23-2	4.68+10	C	63°, 107*
41.17	$2p^6 3d^2 D_{5/2}$	$2p^6 6p^2 P_{3/2}^{\circ}$	678394	3108900		2.2-3	1.3+10	D	63°, 107*
41.137 ^c	$3/2$	$1/2$	675481	3106400		1.8-3	1.5+10	D	107
41.094 ^c	$3/2$	$3/2$	675481	3108900		3.7-4	1.5+9	E	107
40.246 ^c	$2p^6 3d^2 D_{5/2}$	$2p^6 6f^2 F_{5/2}^{\circ}$	678394	3163130		3.0-3	1.2+10	D	107
40.245	$5/2$	$7/2$	678394	3163190	3	6.00-2	1.86+11	C	63, 94 ^a , 107*
40.199	$3/2$	$5/2$	675481	3163130	3	6.30-2	1.74+11	C	94 ^a , 107*
40.162 ^c	$2p^6 3p^2 P_{3/2}^{\circ}$	$2p^6 5d^2 D_{3/2}$	298143	2788050		1.0-2	4.1+10	D	107
40.153	$3/2$	$5/2$	298143	2788610		8.90-2	2.47+11	C	52°, 63, 107*
39.827	$1/2$	$3/2$	277192	2788050		1.00-1	2.11+11	C	52°, 63, 107*
37.138	$2p^6 3d^2 D_{5/2}$	$2p^6 7f^2 F_{7/2}^{\circ}$	678394	3371070	3				63, 94 ^a
37.096	$3/2$	$5/2$	675481	3371210	2				94
36.803	$2p^6 3s^2 S_{1/2}$	$2p^6 5p^2 P_{1/2}^{\circ}$	0	2717170	4	2.3-2	1.1+11	D	94 ^a , 107*
36.749	$1/2$	$3/2$	0	2721160	6	4.67-2	1.15+11	C	63, 94 ^a , 107*
36.01	$2p^6 3p^2 P_{3/2}^{\circ}$	$2p^6 6s^2 S_{1/2}$	298143	3076000					63
35.71	$1/2$	$1/2$	277192	3076000					63
35.368	$2p^6 3d^2 D_{5/2}$	$2p^6 8f^2 F_{7/2}^{\circ}$	678394	3505800	1				63, 94 ^a
35.333	$3/2$	$5/2$	675481	3505700	0				94
35.106	$2p^6 3p^2 P_{3/2}^{\circ}$	$2p^6 6d^2 D_{5/2}$	298143	3146670	6				63, 94 ^a
34.857	$1/2$	$3/2$	277192	3146070	4				63, 94 ^a
34.21	$2p^6 3d^2 D_{5/2}$	$2p^6 9f^2 F_{7/2}^{\circ}$	678394	3600000					63
33.04	$2p^6 3p^2 P_{3/2}^{\circ}$	$2p^6 7s^2 S_{1/2}$	298143	3323000					63
32.84	$1/2$	$1/2$	277192	3323000					63
32.652	$2p^6 3p^2 P_{3/2}^{\circ}$	$2p^6 7d^2 D_{5/2}$	298143	3360800	5				63, 94 ^a
32.433	$1/2$	$3/2$	277192	3360500	3				63, 94 ^a
32.192	$2p^6 3s^2 S_{1/2}$	$2p^6 6p^2 P_{1/2}^{\circ}$	0	3106400	2				94
32.166	$1/2$	$3/2$	0	3108900	3				63, 94 ^a
31.242	$2p^6 3p^2 P_{3/2}^{\circ}$	$2p^6 8d^2 D_{5/2}$	298143	3499000	4				63, 94 ^a
31.041	$1/2$	$3/2$	277192	3498800	1				63, 94 ^a

Fe XVI (Na Sequence) Ionization Energy = 3946150 cm⁻¹ (489.260 eV) — Continued

λ (Å)	Classification	Energy Levels (cm ⁻¹)	Int.	f /Type	A (s ⁻¹)	Acc.	References
30.33	$2p^6 3p^2 P_{3/2}^{\circ}$	$2p^6 9d^2 D_{5/2}$	298143	3595000			63
30.10	$1/2$	$3/2$	277192	3599000			63
29.93	$2p^6 3s^2 S_{1/2}$	$2p^6 7p^2 P_{3/2}^{\circ}$	0	3341000			63
28.67	$2p^6 3s^2 S_{1/2}$	$2p^6 8p^2 P_{3/2}^{\circ}$	0	3488000			63
27.88	$2p^6 3s^2 S_{1/2}$	$2p^6 9p^2 P_{3/2}^{\circ}$	0	3587000			63
17.593	$2p^6 3p^2 P_{3/2}^{\circ}$	$2p^5(^2P_{3/2}^{\circ})3s3p(^3P_1)$ ($\frac{5}{2}, 1$) _{5/2}	298143	5982000	20		30
17.467	$1/2$	$1/2$	277192	6001000	15		30
17.498	$2p^6 3p^2 P_{3/2}^{\circ}$	$2p^5(^2P_{3/2}^{\circ})3s3p(^3P_2)$ ($\frac{5}{2}, 2$) _{5/2}	298143	6013000	40		30
17.498	$3/2$	$3/2$	298143	6013000	40		30
17.413	$3/2$	$1/2$	298143	6042000	15		30
17.498	$2p^6 3d^2 D_{5/2}$	$2p^5(^2P_{3/2}^{\circ})3s3d(^3D_3)$ ($\frac{5}{2}, 3$) _{5/2}	678394	6393000	40		30
17.413	$5/2$	$7/2$	678394	6422000	15		30
17.366	$5/2$	$3/2$	678394	6436000	15		30
17.449	$2p^6 3d^2 D_{3/2}$	$2p^5(^2P_{3/2}^{\circ})3s3d(^3D_1)$ ($\frac{5}{2}, 1$) _{5/2}	675481	6406000	15		30
17.413	$3/2$	$3/2$	675481	6419000	15		30
17.399	$2p^6 3d^2 D_{3/2}$	$2p^5(^2P_{3/2}^{\circ})3s3d(^3D_2)$ ($\frac{5}{2}, 2$) _{1/2}	675481	6423000	20		30
17.399	$3/2$	$5/2$	675481	6425000	20		30
17.399	$5/2$	$5/2$	678394	6425000	20		30
17.337	$2p^6 3d^2 D_{5/2}$	$2p^5(^2P_{3/2}^{\circ})3s3d(^1D_2)$ ($\frac{5}{2}, 2$) _{7/2}	678394	6445000	8		30
17.285	$5/2$	$5/2$	678394	6464000	3		30
17.249	$3/2$	$3/2$	675481	6473000	10		30
17.323	$2p^6 3s^2 S_{1/2}$	$2p^5(^2P^{\circ})3s^2 2P_{3/2}^{\circ}$	0	5773000	2		30 ^a , 93
17.025	$1/2$	$1/2$	0	5873000	9		30 ^a , 93
17.249	$2p^6 3p^2 P_{3/2}^{\circ}$	$2p^5(^2P_{1/2}^{\circ})3s3p(^3P_2)$ ($\frac{1}{2}, 2$) _{3/2}	298143	6096000	10		30
17.249	$2p^6 3p^2 P_{1/2}^{\circ}$	$2p^5(^2P_{1/2}^{\circ})3s3p(^3P_0)$ ($\frac{1}{2}, 0$) _{1/2}	277192	6075000	10		30
17.206	$2p^6 3p^2 P_{1/2}^{\circ}$	$2p^5(^2P_{1/2}^{\circ})3s3p(^3P_1)$ ($\frac{1}{2}, 1$) _{3/2}	277192	6089000	15		30
17.206	$2p^6 3p^2 P_{3/2}^{\circ}$	$2p^5(^2P_{3/2}^{\circ})3s3p(^1P_1)$ ($\frac{3}{2}, 1$) _{5/2}	298143	6110000	15		30
17.206	$1/2$	$1/2$	277192	6089000	15		30
17.161	$3/2$	$3/2$	298143	6129000	15		30
17.087	$1/2$	$3/2$	277192	6129000	15		30
17.161	$2p^6 3d^2 D_{3/2}$	$2p^5(^2P_{1/2}^{\circ})3s3d(^3D_3)$ ($\frac{1}{2}, 3$) _{5/2}	675481	6502000	15		30
17.124	$5/2$	$7/2$	678394	6517000	25		30
17.161	$2p^6 3d^2 D_{3/2}$	$2p^5(^2P_{1/2}^{\circ})3s3d(^3D_1)$ ($\frac{1}{2}, 1$) _{3/2}	675481	6502000	15		30
16.952	$3/2$	$1/2$	675481	6574000	2		30
17.124	$2p^6 3d^2 D_{3/2}$	$2p^5(^2P_{1/2}^{\circ})3s3d(^3D_2)$ ($\frac{1}{2}, 2$) _{5/2}	675481	6516000	25		30
17.124	$5/2$	$5/2$	678394	6516000	25		30
17.087	$5/2$	$3/2$	678394	6530000	15		30
17.025	$2p^6 3d^2 D_{5/2}$	$2p^5(^2P_{1/2}^{\circ})3s3d(^1D_2)$ ($\frac{1}{2}, 2$) _{5/2}	678394	6556000	9		30
16.993	$3/2$	$5/2$	675481	6556000	7		30
16.890	$3/2$	$3/2$	675481	6595000	15		30
16.890	$2p^6 3p^2 P_{3/2}^{\circ}$	$2p^5(^2P_{1/2}^{\circ})3s3p(^1P_1)$ ($\frac{1}{2}, 1$) _{3/2}	298143	6217000	15		30
16.839	$1/2$	$3/2$	277192	6217000	7		30
16.696	$1/2$	$1/2$	277192	6267000			30

Fe xvii (Ne Sequence) Ionization Energy = 10210000 cm⁻¹ (1266 eV)

λ (Å)	Classification	Energy Levels (cm ⁻¹)	Int.	f /Type	A (s ⁻¹)	Acc.	References
437.30	$2p^5(^2P_{3/2}^o)3s(^3\frac{1}{2}, \frac{1}{2})_1^o$	$2p^53p^3S_1$	5864770 6093450	2			27 ^A , 28 ^o
409.91	2	1	5849490 6093450	10			27 ^A , 28 ^o , 42, 101, 130
414.30	$2p^5(^2P_{1/2}^o)3s(^3\frac{1}{2}, \frac{1}{2})_1^o$	$2p^53p^3P_0$	5960870 6202250				28
389.25	$2p^5(^2P_{3/2}^o)3s(^3\frac{1}{2}, \frac{1}{2})_1^o$	$2p^53p^3D_2$	5864770 6121690	20			27 ^A , 28, 42, 101, 130
367.37	2	2	5849490 6121690	25			27 ^A , 28, 42, 101, 130
358.32	1	1	5864770 6143850	20			27 ^A , 28, 42, 101, 130
350.58	2	3	5849490 6134730	100			27 ^A , 28, 101, 104, 130, 171
387.36	$2p^5(^2P_{1/2}^o)3s(^1\frac{1}{2}, \frac{1}{2})_1^o$	$2p^53p^1P_1$	5960870 6219030	10	5.8-2	2.2+9	C 27 ^A , 28, 101, 107*
372.93	0	1	5950880 6219030	25	1.2-1	1.7+9	C 27 ^A , 28, 101, 107*
351.69	$2p^5(^2P_{1/2}^o)3s(^1\frac{1}{2}, \frac{1}{2})_1^o$	$2p^53p^3P_1$	5960870 6245210	8			27 ^A , 28, 101
347.96	1	2	5960870 6248260	35			27 ^A , 28, 42, 101, 130
340.47	$2p^5(^2P_{3/2}^o)3s(^3\frac{1}{2}, \frac{1}{2})_1^o$	$2p^53p^1D_2$	5864770 6158470	45			27 ^A , 28, 42, 101, 130
323.65	2	2	5849490 6158470	35			27 ^A , 28, 42, 101, 130
304.93	$2p^53p^1D_2$	$2p^53d^3P_2^o$	6158470 6486400	30			27 ^A , 28, 101
296.3	$2p^5(^2P_{3/2}^o)3s(^3\frac{1}{2}, \frac{1}{2})_1^o$	$2p^53p^3P_0$	5864770 6202250				27, 28 ^o , 42, 101, 130
288.94	$2p^53p^3P_2$	$2p^53d^1D_2^o$	6248260 6594360				28
287.166 ^c	$2p^53p^1D_2$	$2p^53d^3F_2^o$	6158470 6506700		1.7-2	1.3+9	C 107
284.01	$2p^53p^3D_3$	$2p^53d^3F_4^o$	6134730 6486830	100	1.6-1	1.0+10	C 27 ^A , 28, 42, 101, 104, 107*, 130
279.1	3	3	6134730 6493030				28
275.6	1	2	6143850 6506700	25	5.0-3	2.3+8	27 ^A , 28 ^o , 101, 107*
269.41	2	3	6121690 6493030	55	1.6-1	1.0+10	C 27 ^A , 28, 42 ^o , 101, 107*, 130
259.6	2	2	6121690 6506700				28
281.11	$2p^53p^3P_1$	$2p^53d^3D_2^o$	6245210 6600950	25	1.5-1	7.4+9	C 27 ^A , 28, 42, 101, 107*, 130
280.20	2	3	6248260 6605150		1.6-1	9.1+9	C 27 ^A , 28 ^o , 42, 101, 107*, 130
280.20	$2p^53p^1D_2$	$2p^53d^1F_3^o$	6158470 6515350	85	1.9-1	1.1+10	C 27 ^A , 28, 42, 101, 107*, 130
269.88	$2p^53p^3S_1$	$2p^53d^3P_0^o$	6093450 6463980				28, 42 ^o , 101, 130
266.43	$2p^53p^1P_1$	$2p^53d^1D_2^o$	6219030 6594360	25			27 ^A , 28, 42, 101, 130
264.375 ^c	$2p^53p^3S_1$	$2p^53d^3P_1^o$	6093450 6471800	25	9.8-2	8.8+9	107
254.48	1	2	6093450 6486400	25	8.7-2	5.1+9	27 ^A , 28, 42, 101, 107*, 130
254.75	$2p^5(^2P_{1/2}^o)3s(^1\frac{1}{2}, \frac{1}{2})_1^o$	$2p^53p^1S_0$	5960870 6353410	25	4.2-2	1.3+10	C 27 ^A , 28, 42, 101, 107*, 130
204.6	$2p^5(^2P_{3/2}^o)3s(^3\frac{1}{2}, \frac{1}{2})_1^o$	$2p^53p^1S_0$	5864770 6353410	2	2.5-2	1.2+10	C 27 ^A , 28, 42, 101, 107*, 130
101.416 ^c	$2s^22p^53p^3P_2$	$2s2p^63p^1P_1^o$	6248260 7234300		2.8-2	3.1+10	C 107
95.29	$2s^22p^5(^2P_{1/2}^o)3s(^1\frac{1}{2}, \frac{1}{2})_1^o$	$2s2p^63s^1S_0$	5960870 7010000				104 ^o , 131
87.30	$2s^22p^5(^2P_{3/2}^o)3s(^3\frac{1}{2}, \frac{1}{2})_1^o$	$2s2p^63s^1S_0$	5864770 7010000				104 ^o , 131
59.996 ^c	$2p^53p^1P_1$	$2p^5(^2P_{3/2}^o)4s(^3\frac{1}{2}, \frac{1}{2})_1^o$	6219030 7885800		2.7-2	5.6+10	C 107
59.59	$2p^53d^3D_3^o$	$2p^5(^2P_{3/2}^o)4f^2[\frac{7}{2}]_4$	6605150 8284000				77
59.26	$2p^53d^3F_3^o$	$2p^5(^2P_{1/2}^o)4f^2[\frac{7}{2}]_4$	6493030 8180000				77
58.91	2	3	6506700 8204000				77
59.26	$2p^53d^3D_2^o$	$2p^5(^2P_{3/2}^o)4f^2[\frac{7}{2}]_3$	6600950 8289000				77
58.98	$2p^53d^1D_2^o$	$2p^5(^2P_{1/2}^o)4f^2[\frac{5}{2}]_3$	6594360 8289000				77

Fe XVII (Ne Sequence) Ionization Energy = 10210000 cm⁻¹ (1266 eV) — Continued

λ (Å)	Classification	Energy Levels (cm ⁻¹)	Int.	f /Type	A (s ⁻¹)	Acc.	References
58.98	$2p^5 3d^1 F_3^o$	$2p^5(2P_{3/2}^o)4f^2[2]_4$	6515350	8210000			77
58.76	$2p^5 3d^1 P_2^o$	$2p^5(2P_{3/2}^o)4f^2[2]_2$	6486400	8188000			77
58.76	$2p^5 3d^1 F_4^o$	$2p^5(2P_{3/2}^o)4f^2[2]_2$	6486830	8188000			77
58.62	$2p^5 3d^1 P_2^o$	$2p^5(2P_{3/2}^o)4f^2[2]_3$	6486400	8192000			77
58.62	$2p^5 3d^1 F_4^o$	$2p^5(2P_{3/2}^o)4f^2[2]_4$	6486830	8192000			77
57.893 ^c	$2p^5 3p^1 D_2$	$2p^5(2P_{3/2}^o)4s(\frac{3}{2}, \frac{1}{2})_i^o$	6158470	7885800	6.3-2	2.1+11	C 107
57.646 ^c	$2p^5 3p^1 P_2$	$2p^5(2P_{1/2}^o)4s(\frac{1}{2}, \frac{3}{2})_i^o$	6248260	7983000	3.0-2	1.0+11	C 107
57.407 ^c	$2p^5 3p^1 D_1$	$2p^5(2P_{3/2}^o)4s(\frac{3}{2}, \frac{1}{2})_i^o$	6143850	7885800	2.1-2	4.2+10	C 107
57.32	$2p^5 3p^1 D_3$	$2p^5(2P_{3/2}^o)4s(\frac{3}{2}, \frac{1}{2})_i^o$	6134730	7879000			77
55.54 ^c	$2p^5 3p^1 S_0$	$2p^5 4d^1 D_1^o$	6353410	8154000	1.1-1	7.7+10	C 107
53.54 ^c	$2p^5 3p^1 P_2$	$2p^5 4d^1 P_1^o$	6248260	8116000	2.0-2	8.6+10	C 107
52.75 ^c	$2p^5 3p^1 S_0$	$2p^5 4d^1 P_1^o$	6353410	8249000	3.2-1	2.5+11	C 107
51.20 ^c	$2p^5 3p^1 P_0$	$2p^5 4d^1 D_1^o$	6202250	8154000	2.9-1	2.4+11	C 107
50.262	$2p^5 3p^1 D_3$	$2p^5 4d^1 F_4^o$	6134730	8123600	2.8-1	5.8+11	C 77, 107*, 132°
50.14 ^c	$2p^5 3p^1 D_2$	$2p^5 4d^1 P_1^o$	6121690	8116000	1.3-2	5.7+10	C 107
49.880	$2p^5 3p^1 D_2$	$2p^5 4d^1 D_3^o$	6121690	8125800			77, 132°
49.787	$2p^5 3p^1 D_1$	$2p^5 4d^1 D_2^o$	6143850	8151700			77, 132°
49.44 ^c	$2p^5 3p^1 S_1$	$2p^5 4d^1 P_1^o$	6093450	8116000	1.4-1	3.9+11	C 107
49.26 ^c	$2p^5 3p^1 P_1$	$2p^5 4d^1 P_1^o$	6219030	8249000	4.4-2	1.2+11	C 107
47.50 ^c	$2p^5 3p^1 D_1$	$2p^5 4d^1 P_1^o$	6143850	8249000	3.1-2	8.3+10	C 107
41.37	$2p^5 3d^1 F_4^o$	$2p^5(2P_{3/2}^o)5f^2[2]_5$	6486830	8903000			77
17.097	$2p^6^1 S_0$	$2p^5(2P_{3/2}^o)3s(\frac{3}{2}, \frac{1}{2})_i^o$	0	5849490	M2		123°, 137, 150, 155, 162, 163
17.054	0	1	0	5864770	75	1.22-1	9.34+11 B 20 ^a , 37, 107*, 112°, 123, 137, 150, 155, 161, 162, 163, 191
16.777	$2p^6^1 S_0$	$2p^5(2P_{1/2}^o)3s(\frac{1}{2}, \frac{3}{2})_i^o$	0	5960870	75	1.05-1	8.30+11 B 20 ^a , 37, 107*, 112°, 123, 137, 150, 155, 161, 162, 163, 191
15.450	$2p^6^1 S_0$	$2p^5 3d^1 P_1^o$	0	6471800	30	9.66-3	9.00+10 B 16, 20 ^a , 37, 107*, 112°, 123, 150, 155, 161, 162, 163, 191
15.262	$2p^6^1 S_0$	$2p^5 3d^1 D_1^o$	0	6552200	85	6.29-1	6.01+12 B 16, 20 ^a , 37, 107*, 112°, 123, 137, 150, 161, 162, 163, 191
15.015	$2p^6^1 S_0$	$2p^5 3d^1 P_1^o$	0	6660000	100	2.31	2.28+13 B 16, 20 ^a , 37, 107*, 112°, 123, 137, 150, 161, 162, 163, 191
13.891	$2s^2 2p^6^1 S_0$	$2s 2p^6 3p^1 P_1^o$	0	7198900	40	2.9-2	3.4+11 C 16, 20 ^a , 37, 107*, 112°, 123, 150, 162, 163, 185, 191
13.823	$2s^2 2p^6^1 S_0$	$2s 2p^6 3p^1 P_1^o$	0	7234300	65	2.8-1	3.3+12 C 16, 20 ^a , 37, 107*, 112°, 123, 150, 161, 162, 163, 185, 191
12.681	$2p^6^1 S_0$	$2p^5(2P_{3/2}^o)4s(\frac{3}{2}, \frac{1}{2})_i^o$	0	7885800	20	2.2-2	3.0+11 C 16, 20 ^a , 107*, 112°, 123, 161, 163, 185

Fe XVII (Ne Sequence) Ionization Energy = 10210000 cm⁻¹ (1266 eV) — Continued

λ (Å)	Classification	Energy Levels (cm ⁻¹)	Int.	f /Type	A (s ⁻¹)	Acc.	References
12.526	$2p^6\ ^1S_0$ $2p^5(^2P_{1/2}^o)4s\ (\frac{3}{2}, \frac{1}{2})_i^o$	0 7983000	30	2.5-2	3.5+11	C	16, 20 ^A , 37, 107*, 112°, 123, 161, 163, 185
12.322	$2p^6\ ^1S_0$ $2p^54d\ ^3P_i^o$	0 8116000	35	3.7-3	5.3+10	D	16, 20 ^A , 37, 107*, 112°, 161, 163, 185
12.264	$2p^6\ ^1S_0$ $2p^54d\ ^3D_i^o$	0 8154000	65	4.0-1	5.9+12	C	16, 20 ^A , 37, 107*, 112°, 123, 161, 163, 191
12.123	$2p^6\ ^1S_0$ $2p^54d\ ^1P_i^o$	0 8249000	40	5.3-1	8.0+12	C	16, 20 ^A , 37, 107*, 112°, 123, 161, 163, 191
11.420	$2p^6\ ^1S_0$ $2p^5(^2P_{3/2}^o)5s\ (\frac{3}{2}, \frac{1}{2})_i^o$	0 8757000	3	6.5-3	1.1+11	D	107*, 122 ^A
11.287	$2p^6\ ^1S_0$ $2p^5(^2P_{1/2}^o)5s\ (\frac{1}{2}, \frac{1}{2})_i^o$	0 8860000	2	3.5-3	6.0+10	D	20, 37, 107*, 112°, 122 ^A
11.253	$2p^6\ ^1S_0$ $2p^55d\ ^3D_i^o$	0 8887000	7	1.3-1	2.3+12	D	16, 20, 107*, 112°, 122 ^A , 161, 163, 179, 185
11.133	$2p^6\ ^1S_0$ $2p^55d\ ^1P_i^o$	0 8982000	8	1.8-1	3.2+12	D	16, 20, 37, 107*, 112°, 122 ^A , 161, 163, 179, 185
11.043	$2s^22p^6\ ^1S_0$ $2s2p^64p\ ^3P_i^o$	0 9056000	20	1.6-2	2.9+11	C	20 ^A , 107*, 112°, 123, 179
11.023	$2s^22p^6\ ^1S_0$ $2s2p^64p\ ^1P_i^o$	0 9072000		1.1-1	2.1+12	C	107*, 112°, 123
10.851	$2p^6\ ^1S_0$ $2p^5(^2P_{3/2}^o)6s\ (\frac{3}{2}, \frac{1}{2})_i^o$	0 9216000	1	3.3-3	6.2+10	D	108*, 122 ^A
10.770	$2p^6\ ^1S_0$ $2p^5(^2P_{3/2}^o)6d\ ^2[3]_i^o$	0 9285000	6	6.0-2	1.1+12	D	16, 20, 107*, 112°, 122 ^A , 161, 163, 185
10.658	$2p^6\ ^1S_0$ $2p^5(^2P_{1/2}^o)6d\ ^2[3]_i^o$	0 9383000	3	9.6-2	1.9+12	D	16, 20, 107*, 112°, 122 ^A , 161, 163, 185
10.550	$2p^6\ ^1S_0$ $2p^5(^2P_{3/2}^o)7s\ (\frac{3}{2}, \frac{1}{2})_i^o$	0 9479000	2				122
10.500	$2p^6\ ^1S_0$ $2p^5(^2P_{3/2}^o)7d\ ^2[3]_i^o$	0 9524000	3				16, 122 ^A
10.386	$2p^6\ ^1S_0$ $2p^5(^2P_{1/2}^o)7d\ ^2[3]_i^o$	0 9628000	1				16, 122 ^A
10.320	$2p^6\ ^1S_0$ $2p^5(^2P_{3/2}^o)8d\ ^2[3]_i^o$	0 9690000	2				122
10.221	$2p^6\ ^1S_0$ $2p^5(^2P_{1/2}^o)8d\ ^2[3]_i^o$	0 9784000	1				122
10.123	$2s^22p^6\ ^1S_0$ $2s2p^65p\ ^1P_i^o$	0 9878000	2				122
10.123	$2s^22p^6\ ^1S_0$ $2s2p^65p\ ^3P_i^o$	0 9878000	2				122

Fe XVIII (F Sequence) Ionization Energy = 10950000 cm⁻¹ (1358 eV)

λ (Å)	Classification		Energy Levels (cm ⁻¹)		Int.	f /Type	A (s ⁻¹)	Acc.	References
974.86	$2p^5 \ ^2P_{3/2}^o$	$2p^5 \ ^2P_{1/2}^o$	0	102579		M1	1.93+4	C	48, 103, 116, 117, 135*, 165°, 172, 181
103.939	$2s2p^5 \ ^2P_{1/2}^o$	$2s2p^6 \ ^2S_{1/2}$	102579	1064702	10	5.37-2	3.31+10	C+	14, 19, 41, 45, 96, 107*, 131, 143°, 146°, 152, 165
93.926	$3/2$	$1/2$	0	1064702	10	6.04-2	9.13+10	C+	14, 19, 41, 45, 96, 107*, 131, 143°, 146°, 152, 165
16.337	$2s2p^6 \ ^2S_{1/2}$	$2s2p^5(^3P^o)3s \ ^4P_{5/2}^o$	1064702	7185800		M2			166
16.305	$1/2$	$3/2$	1064702	7197800	65				166
16.234	$1/2$	$1/2$	1064702	7224600	55				166
16.272	$2p^5 \ ^2P_{1/2}^o$	$2p^4(^3P)3s \ ^2P_{3/2}^o$	102579	6248100	7	2.0-3	2.5+10	E	16, 20 ^A , 36, 95, 107*, 112°, 154, 155, 166, 170
16.026	$1/2$	$1/2$	102579	6342600	45	3.9-2	1.0+12	D	16, 20 ^A , 36, 95, 107*, 112°, 166
16.005	$3/2$	$3/2$	0	6248100	70	2.4-3	6.3+10	E	20 ^A , 35, 36, 64, 95, 107*, 112°, 154, 166, 185
15.766	$3/2$	$1/2$	0	6342600	35	2.9-2	1.6+12	D	16, 17, 18, 20 ^A , 36, 95, 107*, 112°, 154, 155, 166, 170
16.165	$2s2p^6 \ ^2S_{1/2}$	$2s2p^5(^3P^o)3s \ ^2P_{3/2}^o$	1064702	7250900	150				16, 35, 36, 155, 166 ^A
16.109	$2p^5 \ ^2P_{1/2}^o$	$2p^4(^3P)3s \ ^4P_{1/2}^o$	102579	6310200		9.0-5	2.3+9	E	16, 36, 95°, 107*, 154, 155, 166, 170
16.087	$1/2$	$3/2$	102579	6317900		3.8-3	4.9+10	E	95°, 107*, 170
16.072	$3/2$	$5/2$	0	6222000	20				16, 20 ^A , 35, 36, 95, 112°, 154, 155, 161, 163, 166, 170, 185
15.828	$3/2$	$3/2$	0	6317900	50	5.5-4	1.5+10	E	16, 20 ^A , 35, 36, 64, 95, 107*, 112°, 154, 155, 161, 166, 170, 185
15.870	$2p^5 \ ^2P_{1/2}^o$	$2p^4(^1D)3s \ ^2D_{3/2}$	102579	6403800	60	7.8-2	1.0+12	D	16, 17, 18, 20 ^A , 36, 95, 107*, 112°, 154, 155, 166, 170, 185
15.625	$3/2$	$5/2$	0	6400000	70	4.6-5	8.4+8	E	16, 17, 18, 20 ^A , 35, 36, 64, 95, 107*, 112°, 154, 155, 161, 166, 170, 185
15.616 ^c	$3/2$	$3/2$	0	6403800		3.8-3	1.0+11	E	107
15.450	$2p^5 \ ^2P_{1/2}^o$	$2p^4(^1S)3s \ ^2S_{1/2}$	102579	6575100	30	3.0-2	8.3+11	D	16, 20 ^A , 36, 95, 107*, 112°, 154, 155, 166, 185
14.802 ^c	$2p^5 \ ^2P_{1/2}^o$	$2p^4(^3P)3d \ ^4P_{1/2}^o$	102579	6858200		3.4-4	1.0+10	E	107
14.772	$1/2$	$3/2$	102579	6872400		2.2-2	3.4+11	E	16, 18, 36, 95°, 107*, 154, 166, 170
14.581	$3/2$	$1/2$	0	6858200	60	3.2-3	2.0+11	E	16, 17, 18, 20 ^A , 36, 95, 107*, 112°, 166, 170, 185
14.551	$3/2$	$3/2$	0	6872400	60	6.1-5	1.9+9	E	16, 20 ^A , 36, 95, 107*, 112°, 154, 166, 170
14.67 ^c	$2p^5 \ ^2P_{1/2}^o$		102579	6919000		2.3-3	3.4+10	E	16, 36, 107*
14.610	$2p^5 \ ^2P_{1/2}^o$	$2p^4(^3P)3d \ ^2P_{3/2}^o$	102579	6947300	35	3.2-2	4.9+11	E	17, 18, 20 ^A , 35, 107*, 112°, 166
14.394 ^c	$3/2$	$3/2$	0	6947300		8.9-4	2.8+10	E	35, 107*, 163, 185
14.534	$2p^5 \ ^2P_{3/2}^o$		0	6880400	70				16, 20 ^A , 36, 95, 112°, 170, 185
14.486	$2p^5 \ ^2P_{3/2}^o$	$2p^4(^3P)3d \ ^4D_{1/2}$	0	6903200	40				20 ^A , 112°
14.469	$2p^5 \ ^2P_{1/2}^o$	$2p^4(^1D)3d \ ^2S_{1/2}$	102579	7014300	35	6.8-2	2.2+12	D	16, 17, 18, 20 ^A , 35, 36, 95, 107*, 112°, 154, 163, 166, 170
14.256	$3/2$	$1/2$	0	7014300	30	1.7-4	1.1+10	E	16, 17, 18, 20 ^A , 36, 95, 107*, 112°, 166, 170, 185

Fe XVIII (F Sequence) Ionization Energy = 10950000 cm⁻¹ (1358 eV) — Continued

λ (Å)	Classification	Energy Levels (cm ⁻¹)	Int.	f /Type	A (s ⁻¹)	Acc.	References
14.453	$2p^5 \ ^2P_{3/2}^o$	0 6919000	35	1.9-2	5.8+11	D	20 ^A , 35, 107*, 112*, 166, 185
14.418	$2p^5 \ ^2P_{1/2}^o$ $2p^4(^1D)3d \ ^2P_{3/2}$	102579 7038400	70	1.0-1	1.6+12	E	16, 17, 18, 20 ^A , 36, 95, 107*, 112*, 154, 166, 170, 185
14.344	$1/2$	$1/2$ 102579 7074200	50	5.3-1	1.7+13	E	17, 18, 20 ^A , 107*, 112*, 166
14.203	$3/2$	$3/2$ 0 7038400		9.8-3	3.2+12	E	17, 18, 35, 107*, 112*, 163, 185
14.373	$2p^5 \ ^2P_{3/2}^o$ $2p^4(^3P)3d \ ^2D_{5/2}$	0 6957500	70				16, 17, 18, 20 ^A , 35, 36, 64, 95*, 112, 154, 163, 166, 185
14.361	$2p^5 \ ^2P_{1/2}^o$ $2p^4(^1D)3d \ ^2D_{3/2}$	102579 7066100	60	5.0-1	8.1+12	E	16, 17, 18, 20 ^A , 36, 95*, 107*, 112, 166, 170
14.203	$3/2$	$5/2$ 0 7040800	60				16, 17, 18, 20 ^A , 35, 64, 95, 112*, 154, 166, 170, 185
14.152	$3/2$	$3/2$ 0 7066100	60	4.1-2	1.4+12	E	16, 17, 18, 20 ^A , 36, 95, 107*, 112*, 166, 170, 185
14.121	$2p^5 \ ^2P_{1/2}^o$ $2p^4(^1S)3d \ ^2D_{3/2}$	102579 7184300	75				16, 17, 18, 20 ^A , 35, 36, 95, 112*, 154, 166, 170, 185
13.954	$3/2$	$5/2$ 0 7166400	55	6.1-2	1.4+12	E	16, 18, 20 ^A , 35, 36, 95*, 107*, 154, 161, 166, 170, 185
13.464	$2s \ 2p^5 \ ^2P_{1/2}^o$ $2s \ 2p^5(^3P^o)3p \ ^4P_{3/2}$	102579 7529900	60				20 ^A , 112°
13.319	$3/2$	$5/2$ 0 7508100	50				20 ^A , 112°, 154
13.397	$2s \ 2p^5 \ ^2P_{3/2}^o$	0 7464400	55				20 ^A , 112°
13.397	$2s \ 2p^5 \ ^2P_{1/2}^o$ $2s \ 2p^5(^3P^o)3p \ ^2D_{3/2}$	102579 7567000	55				20 ^A , 112°
13.374	$3/2$	$5/2$ 0 7477200	50				20 ^A , 112°, 154, 166
13.355	$2s \ 2p^5 \ ^2P_{3/2}^o$ $2s \ 2p^5(^3P^o)3p \ ^2P_{3/2}$	0 7487800	50				20 ^A , 112°
13.319	$3/2$	$1/2$ 0 7508100	50				20 ^A , 112°, 154
13.355	$2s \ 2p^5 \ ^2P_{1/2}^o$ $2s \ 2p^5(^3P^o)3p \ ^2S_{1/2}$	102579 7599400	50				20 ^A , 112°
13.159	$3/2$	$1/2$ 0 7599400	30				20 ^A , 112°, 154, 166
13.049	$2s \ 2p^5 \ ^2P_{1/2}^o$ $2s \ 2p^5(^1P^o)3p \ ^2D_{3/2}$	102579 7763400	45				20 ^A , 112°, 154, 166
12.847	$3/2$	$5/2$ 0 7783900	50				20 ^A , 112°
13.015	$2s \ 2p^5 \ ^2P_{1/2}^o$ $2s \ 2p^5(^1P^o)3p \ ^2P_{1/2}$	102579 7786000	40	1.2-1	4.3+12	D	20 ^A , 107*, 112°, 154, 166
13.001	$1/2$	$3/2$ 102579 7794400					112°, 154
11.865	$2p^5 \ ^2P_{3/2}^o$ $2p^4(^3P_2)4s \ (2, \frac{1}{2})_{3/2}$	0 8428200	20				20 ^A , 112°, 166
11.778	$2p^5 \ ^2P_{1/2}^o$ $2p^4(^1D_2)4s \ (2, \frac{1}{2})_{3/2}$	102579 8593000	15				20 ^A , 112°, 166
11.640	$3/2$	$5/2$ 0 8591100	15				20 ^A , 112°, 179
11.741	$2p^5 \ ^2P_{3/2}^o$ $2p^4(^3P_1)4s \ (1, \frac{1}{2})_{3/2}$	0 8517200	10				20 ^A , 112°
11.526	$2p^5 \ ^2P_{3/2}^o$ $2p^4(^3P_2)4d \ (2, \frac{5}{2})_{5/2}$	0 8676000	50				16, 20 ^A , 23, 112°, 154, 166, 185
11.526	$3/2$	$3/2$ 0 8676000	50				20 ^A , 112°, 154, 166
11.551	$2p^5 \ ^2P_{1/2}^o$ $2p^4(^3P_1)4d \ (1, \frac{5}{2})_{3/2}$	102579 8759900	25	9.5-2	2.4+12	E	16, 20 ^A , 107*, 112°, 166, 185
11.442	$3/2$	$3/2$ 0 8759900					16*, 36, 185
11.420	$3/2$	$5/2$ 0 8756600					112°, 166
11.458	$2p^5 \ ^2P_{3/2}^o$ $2p^4(^3P_0)4d \ (0, \frac{3}{2})_{3/2}$	0 8727500	30				20 ^A , 112°, 166
11.458	$2p^5 \ ^2P_{3/2}^o$ $2p^4(^3P_0)4d \ (0, \frac{5}{2})_{5/2}$	0 8727500	30				20 ^A , 112°, 166
11.440	$2p^5 \ ^2P_{1/2}^o$ $2p^4(^1D_2)4d \ (2, \frac{3}{2})_{3/2}$	102579 8843900	50	1.7-1	4.3+12	D	20 ^A , 107*, 112°, 154, 166
11.326	$3/2$	$1/2$ 0 8829200	55	4.5-2	4.7+12	D	20 ^A , 107*, 112°, 154, 166, 179
11.326	$3/2$	$5/2$ 0 8829200	55				20 ^A , 112°, 154, 166, 179

Fe XVIII (F Sequence) Ionization Energy = 10950000 cm⁻¹ (1358 eV) — Continued

λ (Å)	Classification		Energy Levels (cm ⁻¹)		Int.	f /Type	A (s ⁻¹)	Acc.	References
11.440	$2p^5 \ ^2P_{1/2}^\circ$	$2p^4(^1D_2)4d (2, \frac{5}{2})_{1/2}$	102579	8843900	50	1.4-1	7.1+12	D	20 ^A , 23, 107*, 112*, 154, 166
11.326	$ _{3/2}$	$ (2, \frac{5}{2})_{3/2}$	0	8829200	55				16, 20 ^A , 112*, 166, 185
11.326	$ _{3/2}$	$ (2, \frac{5}{2})_{3/2}$	0	8829200	55	7.8-2	4.1+12	D	20 ^A , 23, 107*, 112*, 154, 166, 179
11.253	$2p^5 \ ^2P_{1/2}^\circ$	$2p^4(^1S_0)4d (0, \frac{3}{2})_{3/2}$	102579	8989200	45	1.2-1	3.2+12	D	20 ^A , 23, 107*, 112*, 154, 166, 179
10.51	$2p^5 \ ^2P_{3/2}^\circ$	$2p^4(^3P)5d \ ^2D_{5/2}$	0	9510000					29
10.48	$2p^5 \ ^2P_{1/2}^\circ$	$2p^4(^3P)5d \ ^2P_{3/2}$	102579	9640000					29
10.44	$2p^5 \ ^2P_{1/2}^\circ$	$2p^4(^1D)5d \ ^2D_{3/2}$	102579	9680000					29
10.44	$2p^5 \ ^2P_{1/2}^\circ$	$2p^4(^1D)5d \ ^2P_{1/2}$	102579	9680000					29
10.33	$ _{3/2}$	$ _{1/2}$	0	9680000					29
10.41	$2p^5 \ ^2P_{3/2}^\circ$	$2p^4(^3P)5d \ ^2F_{5/2}$	0	9610000					29
10.33	$2p^5 \ ^2P_{3/2}^\circ$	$2p^4(^1D)5d \ ^2F_{5/2}$	0	9680000					29
10.03	$2p^5 \ ^2P_{3/2}^\circ$	$2p^4(^3P)6d \ ^2D_{5/2}$	0	9970000					29
9.98	$2p^5 \ ^2P_{1/2}^\circ$	$2p^4(^1D)6d \ ^2D_{3/2}$	102579	10120000					29
9.98	$2p^5 \ ^2P_{1/2}^\circ$	$2p^4(^1D)6d \ ^2P_{1/2}$	102579	10120000					29
1.92164	$1s^2 2s^2 2p^5 \ ^2P_{3/2}^\circ$	$1s 2s^2 2p^6 \ ^2S_{1/2}$	0	52039000					106, 175*

Fe XIX (O Sequence) Ionization Energy = 11740000 cm⁻¹ (1456 eV)

λ (Å)	Classification		Energy Levels (cm ⁻¹)		Int.	f /Type	A (s ⁻¹)	Acc.	References
1118.060	$2p^4\ ^3P_2$	$2p^4\ ^3P_1$	0	89441		M1	1.45+4	C	48, 103, 116, 117, 135*, 165°, 172, 181
592.234	$2p^4\ ^3P_2$	$2p^4\ ^1D_2$	0	168852		M1	1.73+4	C	103, 117, 135*, 165°, 199
424.26	$2p^4\ ^3P_1$	$2p^4\ ^1S_0$	89441	325140		M1	1.50+5	C	135*, 199°
151.61°	$2s^2 2p^4\ ^1S_0$	$2s 2p^5\ ^3P_1^o$	325140	984740		8.2-3	8.2+8	E	107
132.63	$2s^2 2p^4\ ^1D_2$	$2s 2p^5\ ^3P_2^o$	168852	922890	4	5.9-3	2.3+9	E	107*, 146° ^A
119.983	$2s^2 2p^4\ ^3P_1$	$2s 2p^5\ ^3P_2^o$	89441	922890	8	3.74-2	1.04+10	C	19, 41, 45, 75, 96, 107*, 131, 139, 143°, 146° ^A
111.695	1	1	89441	984740	5	2.35-2	1.26+10	C	19, 41, 45, 75, 96, 107*, 131, 139, 143°, 146° ^A
109.952	0	1	75250	984740	6	8.7-2	1.6+10	C	41, 45, 75, 96, 107*, 131, 139, 143°, 146° ^A
108.355	2	2	0	922890	10	6.8-2	3.9+10	C	19, 41, 45, 75, 96, 107*, 131, 139, 143°, 146° ^A , 165
106.318	1	0	89441	1030020	6	3.42-2	6.10+10	C	41, 45, 96, 107*, 131, 139, 143°, 146° ^A
101.550	2	1	0	984740	8	2.94-2	3.20+10	C	19, 41, 45, 75, 96, 107*, 131, 139, 143°, 146° ^A , 165
115.396	$2s 2p^5\ ^1P_1^o$	$2p^6\ ^1S_0$	1267600	2134180	7	1.07-1	1.61+11	C	74, 107*, 143°, 146° ^A
106.107	$2s^2 2p^4\ ^1S_0$	$2s 2p^5\ ^1P_1^o$	325140	1267600	4	5.4-2	1.1+10	C	41, 45, 96, 107*, 131, 139, 143°, 146° ^A
91.012	$2s^2 2p^4\ ^1D_2$	$2s 2p^5\ ^1P_1^o$	168852	1267600	9	1.11-1	1.49+11	C	19, 41, 45, 96, 107*, 131, 139, 143°, 146° ^A
86.999	$2s 2p^5\ ^3P_1^o$	$2p^6\ ^1S_0$	984740	2134180	1	4.5-3	1.3+10	E	107*, 143°, 146° ^A
84.874	$2s^2 2p^4\ ^3P_1$	$2s 2p^5\ ^1P_1^o$	89441	1267600	1	1.0-3	9.6+8	E	107*, 139, 143°, 146° ^A
83.870	0	1	75250	1267600	1	5.0-3	1.6+9	E	107*, 139, 143°, 146° ^A
78.888	2	1	0	1267600	4	7.1-3	1.3+10	E	107*, 139, 141, 143°, 146° ^A
15.172	$2p^4\ ^3P_1$	$2p^3(^4S^o)3s\ ^3S_1^o$	89441	6680000	25				16, 20 ^A , 36, 112°, 154, 166, 185
15.138	0	1	75250	6680000	5				16, 20 ^A , 112°, 161, 185
14.966	2	1	0	6680000	35				16, 20 ^A , 36, 112°, 154, 166, 185
15.111	$2p^4\ ^1D_2$	$2p^3(^2D^o)3s\ ^3D_2^o$	168852	6787000	10				20 ^A , 112°
15.015	$2p^4\ ^1S_0$	$2p^3(^2P^o)3s\ ^1P_1^o$	325140	6985000	100				20 ^A , 112°
14.995	$2p^4\ ^1D_2$	$2p^3(^2D^o)3s\ ^1D_2^o$	168852	6834000	55				20 ^A , 112°
14.929	$2p^4\ ^3P_1$	$2p^3(^2D^o)3s\ ^3D_1^o$	89441	6788000	30				20 ^A , 112°, 154, 166
14.929	1	2	89441	6787000	30				20 ^A , 112°, 154, 166
14.735	2	2	0	6787000	40				20 ^A , 112°, 154, 166
14.668	2	3	0	6818000	55				20 ^A , 112°, 154, 166
14.823	$2p^4\ ^3P_1$	$2p^3(^2D^o)3s\ ^1D_2^o$	89441	6834000	15				20 ^A , 112°
14.806	$2p^4\ ^1D_2$	$2p^3(^2P^o)3s\ ^3P_1^o$	168852	6923000	20				16, 20 ^A , 112°, 185
14.668	$2p^4\ ^3P_1$	$2p^3(^2P^o)3s\ ^3P_0^o$	89441	6907000	55				20 ^A , 112°
14.534	1	2	89441	6970000	70				20 ^A , 112°

Fe XIX (O Sequence) Ionization Energy = 11740000 cm⁻¹ (1456 eV) — Continued

λ (Å)	Classification	Energy Levels (cm ⁻¹)	Int.	f /Type	A (s ⁻¹)	Acc.	References
13.795	$2p^4 \ ^3P_2$	$2p^3(^4S_{3/2})3d \ (\frac{5}{2}, \frac{5}{2})_3^3$	0 7249000	55	2.3-1	5.7+12	D 20 ^A , 107*, 112°, 154, 166, 167
13.735	$2p^4 \ ^1S_0$	$2p^3(^2P_{3/2}^o)3d \ (\frac{5}{2}, \frac{5}{2})_1^1$	325140 7606000	45	2.2	2.6+13	D 20 ^A , 107*, 112°
13.735	$2p^4 \ ^1D_2$	$2p^3(^2P_{1/2}^o)3d \ (\frac{5}{2}, \frac{5}{2})_3^1$	168852 7450000	45	9.4-2	2.4+12	E 20 ^A , 107*, 112°
13.700	2	2	168852 7468000	45			20 ^A , 112°, 167
13.735	$2p^4 \ ^3P_1$	$2p^3(^2D_{3/2}^o)3d \ (\frac{5}{2}, \frac{5}{2})_2^3$	89441 7370000	45			20 ^A , 112°, 166, 167
13.735	$2p^4 \ ^1D_2$	$2p^3(^2D_{5/2}^o)3d \ (\frac{5}{2}, \frac{5}{2})_3^1$	168852 7449000	45	3.0-1	7.5+12	E 20 ^A , 107*, 112°
13.520	$2p^4 \ ^3P_2$	$2p^3(^2D_{3/2}^o)3d \ (\frac{5}{2}, \frac{5}{2})_3^3$	0 7396000	75	7.3-1	1.9+13	D 20 ^A , 107*, 112°, 154, 166
13.520	$2p^4 \ ^1D_2$	$2p^3(^2P_{3/2}^o)3d \ (\frac{5}{2}, \frac{5}{2})_3^1$	168852 7565000	75			20 ^A , 112°
13.504	$2p^4 \ ^3P_2$	$2p^3(^2D_{5/2}^o)3d \ (\frac{5}{2}, \frac{5}{2})_2^3$	0 7405000	55			20 ^A , 112°, 166, 167
13.464	$2p^4 \ ^3P_1$	$2p^3(^2P_{3/2}^o)3d \ (\frac{5}{2}, \frac{5}{2})_1^3$	89441 7567000	60			20 ^A , 112°, 167
13.397	1	2	89441 7554000	55			20 ^A , 112°, 166, 167
13.424	$2p^4 \ ^3P_2$	$2p^3(^2D_{5/2}^o)3d \ (\frac{5}{2}, \frac{5}{2})_3^3$	0 7449000	50	2.1-1	5.5+12	E 20 ^A , 107*, 112°, 166
10.933	$2p^4 \ ^3P_1$	$2p^3(^4S_{3/2})4d \ (\frac{5}{2}, \frac{5}{2})_2^3$	89441 9242000	25	4.0-2	1.3+12	D 20 ^A , 23, 33, 107*, 112°, 166, 179
10.907	0	1	75250 9244000	20	1.5-1	2.8+12	D 20 ^A , 23, 33, 107*, 112°
10.813	2	3	0 9248000	55	1.2-1	4.9+12	D 20 ^A , 107*, 112°, 154, 166, 179
10.813	2	2	0 9242000	55			20 ^A , 112°
10.813	$2p^4 \ ^1D_2$	$2p^3(^2D_{5/2}^o)4d \ (\frac{5}{2}, \frac{5}{2})_2^1$	168852 9417000	55	8.2-2	4.7+12	D 20 ^A , 107*, 112°, 179
10.813	2	3	168852 9417000	55	1.3-1	5.3+12	D 20 ^A , 107*, 112°, 179
10.813	$2p^4 \ ^1S_0$	$2p^3(^2P_{3/2}^o)4d \ (\frac{5}{2}, \frac{5}{2})_1^1$	325140 9573000	55	4.4-1	8.4+12	E 20 ^A , 23, 33, 107*, 112°, 179
10.770	$2p^4 \ ^3P_1$	$2p^3(^2D_{3/2}^o)4d \ (\frac{5}{2}, \frac{5}{2})_2^3$	89441 9374000	35			20 ^A , 23, 33, 112°, 166, 179
10.736	$2p^4 \ ^1D_2$	$2p^3(^2P_{1/2}^o)4d \ (\frac{5}{2}, \frac{5}{2})_3^1$	168852 9483000	20	3.8-2	1.6+12	E 20 ^A , 23, 33, 107*, 112°, 179
10.685	$2p^4 \ ^3P_2$	$2p^3(^2D_{3/2}^o)4d \ (\frac{5}{2}, \frac{5}{2})_3^3$	0 9359000	25			20 ^A , 23, 33, 112°, 166, 179
10.658	$2p^4 \ ^3P_2$	$2p^3(^2D_{5/2}^o)4d \ (\frac{5}{2}, \frac{5}{2})_3^3$	0 9383000	35	7.6-2	3.2+12	D 20 ^A , 107*, 112°, 166
10.644	2	2	0 9395000	35			20 ^A , 112°, 166
10.635	2	1	0 9403000	40	4.4-2	4.3+12	D 20 ^A , 23, 33, 107*, 112°, 166, 179
10.658	$2p^4 \ ^1D_2$	$2p^3(^2P_{3/2}^o)4d \ (\frac{5}{2}, \frac{5}{2})_3^1$	168852 9552000	35			20 ^A , 23, 33, 112°
10.635	$2p^4 \ ^3P_1$	$2p^3(^2P_{1/2}^o)4d \ (\frac{5}{2}, \frac{5}{2})_2^3$	89441 9492000	40			20 ^A , 112°
10.617	$2p^4 \ ^3P_0$	$2p^3(^2P_{1/2}^o)4d \ (\frac{5}{2}, \frac{5}{2})_1^3$	75250 9494000	25	2.4-1	4.7+12	E 20 ^A , 23, 33, 107*, 112°, 166
10.564	$2p^4 \ ^3P_1$	$2p^3(^2P_{3/2}^o)4d \ (\frac{5}{2}, \frac{5}{2})_1^3$	89441 9556000	35	5.3-2	3.2+12	E 20 ^A , 23, 33, 107*, 112°, 166, 179
9.82	$2p^4 \ ^1S_0$	$2p^3(^2P^o)5d \ ^1P_1^o$	325140 10510000				29
9.81	$2p^4 \ ^3P_2$	$2p^3(^4S^o)5d \ ^3D_3^o$	0 10190000	20			20 ^A , 29°
9.81	$2p^4 \ ^1D_2$	$2p^3(^2D^o)5d \ ^1F_3^o$	168852 10390000	20			20 ^A , 29°
9.81	$2p^4 \ ^1D_2$	$2p^3(^2D^o)5d \ ^1D_2^o$	168852 10360000	20			20 ^A , 29°
9.78	$2p^4 \ ^3P_1$	$2p^3(^2D^o)5d \ ^3D_2^o$	89441 10330000	10			20 ^A , 29°
9.68	2	3	0 10330000	15			20 ^A , 29°
9.68	2	2	0 10330000				29

Fe XIX (O Sequence)

Ionization Energy = 11740000 cm⁻¹ (1456 eV) — Continued

λ (Å)	Classification		Energy Levels (cm ⁻¹)		Int.	f /Type	A (s ⁻¹)	Acc.	References
9.68	$2p^4 \ ^1D_2$	$2p^3(^2P^o)5d \ ^1F_3^o$	168852	10500000	15				20 ^a , 29 ^o
9.64	$2p^4 \ ^3P_0$	$2p^3(^2P^o)5d \ ^3D_1^o$	75250	10450000					29
9.52	2	3	0	10500000					29
9.61	$2p^4 \ ^3P_1$	$2p^3(^2P^o)5d \ ^3P_1^o$	89441	10500000					29
9.44	$2p^4 \ ^3P_1$	$2p^3(^4S^o)6d \ ^5D_2^o$	89441	10680000					29
9.36	$2p^4 \ ^3P_0$	$2p^3(^2P^o)6d \ ^3D_1^o$	75250	10760000					29
9.34	$2p^4 \ ^3P_2$	$2p^3(^4S^o)6d \ ^3D_3^o$	0	10710000					29
9.21	$2p^4 \ ^1D_2$	$2p^3(^2D^o)6d \ ^1F_3^o$	168852	11030000					29
1.91765	$1s^2 2s^2 2p^4 \ ^3P_2$	$1s 2s^2 2p^5 \ ^3P_2^o$	0	52147200					148, 175 ^c

Fe XX (N Sequence)

Ionization Energy = 12760000 cm⁻¹ (1582 eV)

λ (Å)	Classification		Energy Levels (cm ⁻¹)		Int.	f /Type	A (s ⁻¹)	Acc.	References
2665.1	$2p^3 \ ^2D_{3/2}$	$2p^3 \ ^2D_{5/2}$	138620	176130		M1	2.91+4	C	117, 135*, 180*, 181
541.35	$2p^3 \ ^2D_{3/2}$	$2p^3 \ ^2P_{3/2}$	138620	323340		M1	4.49+4	C	103, 135*, 199*
567.76	$2p^3 \ ^4S_{3/2}$	$2p^3 \ ^2D_{5/2}$	0	176130		M1	1.27+3	C	59, 135*, 147, 199*
309.26	$2p^3 \ ^4S_{3/2}$	$2p^3 \ ^2P_{3/2}$	0	323340		M1	2.91+4	C	59, 135*, 147, 171*
232.89 ^c	$2s^2 2p^3 \ ^2P_{3/2}$	$2s 2p^4 \ ^4P_{5/2}$	323340	752730		3.3-4	2.7+7	E	107
201.01 ^c	$3/2$	$3/2$	323340	820820		1.1-3	1.8+8	E	107
171.68 ^c	$1/2$	$1/2$	260270	842740		1.1-3	2.5+8	E	107
173.43 ^c	$2s^2 2p^3 \ ^2D_{5/2}$	$2s 2p^4 \ ^4P_{5/2}$	176130	752730		1.2-3	2.6+8	E	107
162.84 ^c	$3/2$	$5/2$	138620	752730		3.8-3	6.3+8	E	107
155.11 ^c	$5/2$	$3/2$	176130	820820		1.1-4	4.5+7	E	107
146.58 ^c	$3/2$	$3/2$	138620	820820		4.2-4	1.3+8	E	107
142.02 ^c	$3/2$	$1/2$	138620	842740		5.1-4	3.3+8	E	107
162.739 ^c	$2s 2p^4 \ ^2P_{1/2}$	$2p^5 \ ^2P_{3/2}$	1340040	1954520		1.42-2	1.78+9	C	107
140.44	$3/2$	$3/2$	1242430	1954520	4	9.2-2	3.1+10	C	107*, 138, 146 ^a
138.49	$1/2$	$1/2$	1340040	2062200	2	9.3-2	3.2+10	C	107*, 138, 146 ^a
122.00	$3/2$	$1/2$	1242430	2062200	3	4.13-2	3.70+10	C	107*, 138, 146 ^a
139.04 ^c	$2s^2 2p^3 \ ^2P_{3/2}$	$2s 2p^4 \ ^2D_{3/2}$	323340	1042570		2.0-3	6.9+8	D	107
136.052	$3/2$	$5/2$	323340	1058360	3	2.50-2	6.00+9	C	74, 107*, 138, 143*, 146 ^a
127.86	$1/2$	$3/2$	260270	1042570	1	1.46-2	2.97+9	C	107*, 146 ^a
132.850	$2s^2 2p^3 \ ^4S_{3/2}$	$2s 2p^4 \ ^4P_{5/2}$	0	752730	10	5.2-2	1.3+10	C	19, 41, 45, 74, 75, 107*, 131, 138, 146 ^a , 165 ^o
121.83	$3/2$	$3/2$	0	820820	7	4.13-2	1.86+10	C	19, 41, 45, 74, 75, 107*, 131, 138, 146 ^a
118.66	$3/2$	$1/2$	0	842740	8	2.21-2	2.09+10	C	19, 41, 45, 75, 107*, 131, 138, 146 ^a
131.70	$2s 2p^4 \ ^2S_{1/2}$	$2p^5 \ ^2P_{3/2}$	1195260	1954520	2	4.69-2	9.00+9	C	107*, 138, 146 ^a
115.35 ^c	$1/2$	$1/2$	1195260	2062200		4.6-3	2.3+9	D	107

Fe xx (N Sequence) Ionization Energy = 12760000 cm⁻¹ (1582 eV) — Continued

λ (Å)	Classification		Energy Levels (cm ⁻¹)		Int.	f /Type	A (s ⁻¹)	Acc.	References
115.41 ^c	$2s^2 2p^3 \ ^2D_{5/2}^o$	$2s 2p^4 \ ^2D_{3/2}$	176130	1042570		5.7-5	4.3+7	E	107
113.349	$5/2$	$5/2$	176130	1058360	10	6.3-2	3.3+10	C	19, 41, 45, 74, 107*, 131, 138, 143 ^a , 146 ^a
110.626	$3/2$	$3/2$	138620	1042570	8	7.8-2	4.2+10	C	19, 41, 45, 74, 107*, 131, 138, 143 ^a , 146 ^a
108.73 ^c	$3/2$	$5/2$	138620	1058360		7.1-5	2.7+7	E	107
114.72	$2s^2 2p^3 \ ^2P_{3/2}^o$	$2s 2p^4 \ ^2S_{1/2}$	323340	1195260	1	3.0-3	3.0+9	D	107*, 131, 146 ^a
106.955	$1/2$	$1/2$	260270	1195260	5	6.4-2	3.7+10	C	97, 107*, 131, 138, 143 ^a , 146 ^a
111.586	$2s 2p^4 \ ^2D_{5/2}$	$2p^5 \ ^2P_{3/2}^o$	1058360	1954520	6	5.4-2	4.3+10	C	47, 107*, 138, 143 ^a , 146 ^a
109.657	$3/2$	$3/2$	1042570	1954520	4	3.17-2	1.76+10	C	47, 107*, 138, 143 ^a , 146 ^a
98.075	$3/2$	$1/2$	1042570	2062200	4	3.33-2	4.62+10	C	47, 107*, 138, 143 ^a , 146 ^a
108.803	$2s^2 2p^3 \ ^2P_{3/2}^o$	$2s 2p^4 \ ^2P_{3/2}$	323340	1242430	4	1.67-2	9.40+9	C	45, 107*, 131, 138, 143 ^a , 146 ^a
101.816	$1/2$	$3/2$	260270	1242430	3	2.84-2	9.10+9	C	19, 45, 107*, 131, 138, 143 ^a , 146 ^a
98.358	$3/2$	$1/2$	323340	1340040	9	7.0-2	9.7+10	C	19, 41, 45, 107*, 131, 138, 143 ^a , 146 ^a
92.63	$1/2$	$1/2$	260270	1340040	1	5.7-3	4.4+9	D	107*, 131, 146 ^a
95.95	$2s^2 2p^3 \ ^4S_{3/2}$	$2s 2p^4 \ ^2D_{3/2}$	0	1042570	2	2.6-3	1.9+9	E	41, 107*, 146 ^a
94.638	$2s^2 2p^3 \ ^2D_{3/2}^o$	$2s 2p^4 \ ^2S_{1/2}$	138620	1195260	5	3.0-2	4.5+10	D	41, 97, 107*, 138, 143 ^a , 146 ^a
93.782	$2s^2 2p^3 \ ^2D_{5/2}^o$	$2s 2p^4 \ ^2P_{3/2}$	176130	1242430	8	8.9-2	1.0+11	C	19, 45, 74, 107*, 131, 138, 143 ^a , 146 ^a
90.595	$3/2$	$3/2$	138620	1242430	4	1.81-2	1.47+10	C	41, 45, 107*, 138, 143 ^a , 146 ^a
83.235	$3/2$	$1/2$	138620	1340040	4	1.51-2	2.91+10	C	41, 45, 74, 107*, 138, 143 ^a , 146 ^a
89.95 ^c	$2s 2p^4 \ ^4P_{1/2}$	$2p^5 \ ^2P_{3/2}^o$	842740	1954520		1.3-3	5.6+8	E	107
88.24	$3/2$	$3/2$	820820	1954520	1	1.9-3	1.7+9	E	107*, 146 ^a
83.23	$5/2$	$3/2$	752730	1954520	4	2.1-3	3.2+9	E	107*, 146 ^a
82.00 ^c	$1/2$	$1/2$	842740	2062200		9.7-4	1.0+9	E	107
80.59	$3/2$	$1/2$	820820	2062200	1	1.3-4	2.8+8	E	107*, 146 ^a
83.69	$2s^2 2p^3 \ ^4S_{3/2}$	$2s 2p^4 \ ^2S_{1/2}$	0	1195260	1	1.0-3	1.9+9	E	107*, 146 ^a
80.51	$2s^2 2p^3 \ ^4S_{3/2}$	$2s 2p^4 \ ^2P_{3/2}$	0	1242430	2	4.5-3	4.7+9	E	41, 107*, 146 ^a
13.298 ^c	$2p^3 \ ^2P_{3/2}^o$	$2p^2(^3P)3d \ ^2D_{5/2}$	323340	7843000					76, 161, 185
13.159	$1/2$	$3/2$	260270	7859000	30	5.0-1	9.6+12	D	20 ^a , 107*
13.176 ^c	$2p^3 \ ^2P_{3/2}^o$	$2p^2(^1D)3d \ ^2D_{5/2}$	323340	7913000		6.5-2	1.7+12	E	76, 107*, 185
13.082	$2p^3 \ ^2P_{3/2}^o$	$2p^2(^1D)3d \ ^2F_{5/2}$	323340	7983000	55				20 ^a , 36, 73
13.082	$2p^3 \ ^2P_{3/2}^o$	$2p^2(^1D)3d \ ^2P_{3/2}$	323340	7967000	55	3.9-1	1.5+13	D	20 ^a , 36, 73, 107*
13.082	$2p^3 \ ^2D_{5/2}^o$	$2p^2(^3P)3d \ ^2F_{7/2}$	176130	7820000	55				20 ^a , 36, 73, 76, 161, 185
13.049	$2p^3 \ ^2D_{5/2}^o$	$2p^2(^3P)3d \ ^2D_{5/2}$	176130	7843000	50	1.5-1	5.9+12	E	20 ^a , 76, 107*, 185
12.978	$3/2$	$5/2$	138620	7843000	40	5.6-1	1.5+13	D	20 ^a , 107*, 154
12.946	$2p^3 \ ^2P_{3/2}^o$	$2p^2(^1S)3d \ ^2D_{5/2}$	323340	8047000	50	5.3-1	1.4+13	D	20 ^a , 107*
12.924	$2p^3 \ ^2D_{5/2}^o$	$2p^2(^1D)3d \ ^2D_{5/2}$	176130	7913000	55	2.4-1	9.6+12	E	20 ^a , 107*, 161
12.857	$3/2$	$3/2$	138620	7919000	30	3.0-1	1.2+13	D	20 ^a , 107*
12.847	$3/2$	$5/2$	138620	7913000	50	4.2-1	1.1+13	E	20 ^a , 107*, 154
12.888	$2p^3 \ ^2D_{5/2}^o$	$2p^2(^1D)3d \ ^2F_{7/2}$	176130	7935000	45				20 ^a , 36, 69, 73, 76, 161, 185
12.763	$3/2$	$5/2$	138620	7983000	30				20 ^a , 76, 154, 161, 185

Fe xx (N Sequence) Ionization Energy = 12760000 cm⁻¹ (1582 eV) — Continued

λ (Å)	Classification		Energy Levels (cm ⁻¹)		Int.	f /Type	A (s ⁻¹)	Acc.	References
12.818	$2p^3 \ ^4S_{3/2}$	$2p^2(^3P)3d \ ^4P_{3/2}$	0	7802000	50	5.2-1	2.1+13	D	20 ^a , 36, 69, 73, 107*, 154, 161, 166
12.818	$3/2$	$5/2$	0	7802000	50	5.6-1	1.5+13	E	20 ^a , 36, 69, 73, 107*, 154, 161, 166
10.222	$2p^3 \ ^2P_{1/2}$	$2p^2(^3P)4d \ ^2D_{3/2}$	260270	10043000	20				20
10.177	$2p^3 \ ^2P_{3/2}$	$2p^2(^1D)4d \ ^2P_{3/2}$	323340	10149000	20				20
10.177	$2p^3 \ ^2D_{3/2}$	$2p^2(^3P)4d \ ^2F_{5/2}$	138620	9964000	20				20
10.159	$5/2$	$7/2$	176130	10019000	20				20
10.177	$2p^3 \ ^2P_{3/2}$	$2p^2(^1D)4d \ ^2F_{5/2}$	323340	10149000	20				20
10.159	$2p^3 \ ^2D_{5/2}$	$2p^2(^3P)4d \ ^2D_{5/2}$	176130	10019000	20				20
10.121	$3/2$	$5/2$	138620	10019000	25				20
10.121	$2p^3 \ ^4S_{3/2}$	$2p^2(^3P)4d \ ^4P_{5/2}$	0	9880000	25				20
9.991	$3/2$	$3/2$	0	10009000	25				20
9.991	$3/2$	$1/2$	0	10009000	25				20
10.058	$2p^3 \ ^4S_{3/2}$	$2p^2(^3P)4d \ ^4F_{5/2}$	0	9942000	25				20
10.034	$2p^3 \ ^2D_{5/2}$	$2p^2(^1D)4d \ ^2D_{5/2}$	176130	10142000	25				20
10.008	$3/2$	$3/2$	138620	10130000	20				20
10.034	$2p^3 \ ^2P_{3/2}$	$2p^2(^1S)4d \ ^2D_{5/2}$	323340	10289000	25				20
9.991	$1/2$	$3/2$	260270	10269000	25				20
10.034	$2p^3 \ ^2D_{5/2}$	$2p^2(^1D)4d \ ^2G_{7/2}$	176130	10142000	25				20
10.008	$2p^3 \ ^4S_{3/2}$	$2p^2(^3P)4d \ ^4D_{5/2}$	0	9992000	20				20
9.220	$2p^3 \ ^2P_{3/2}$	$2p^2(^1D)5d \ ^2P_{3/2}$	323340	11169000	30				16
9.220	$2p^3 \ ^2P_{3/2}$	$2p^2(^1D)5d \ ^2F_{5/2}$	323340	11169000	30				16
9.208	$2p^3 \ ^2D_{3/2}$	$2p^2(^3P)5d \ ^2F_{5/2}$	138620	10998000	25				16
9.199	$5/2$	$7/2$	176130	11047000	30				16
9.208	$2p^3 \ ^2D_{5/2}$	$2p^2(^3P)5d \ ^2D_{5/2}$	176130	11036000	25				16
9.110	$2p^3 \ ^2D_{5/2}$	$2p^2(^1D)5d \ ^2G_{7/2}$	176130	11153000	40				16
9.110	$2p^3 \ ^2D_{5/2}$	$2p^2(^1D)5d \ ^2D_{5/2}$	176130	11153000	40				16
9.073	$3/2$	$3/2$	138620	11160000	20				16
9.110	$2p^3 \ ^4S_{3/2}$	$2p^2(^3P)5d \ ^4F_{5/2}$	0	10977000	40				16
9.065	$2p^3 \ ^4S_{3/2}$	$2p^2(^3P)5d \ ^4D_{5/2}$	0	11031000	40				16
1.90845	$1s^2 2s^2 2p^3 \ ^4S_{3/2}$	$1s 2s^2 2p^4 \ ^4P_{5/2}$	0	52398500	130				175
1.90568	$3/2$	$3/2$	0	52474700	80				100, 148, 175 ^a
1.9051	$3/2$	$1/2$	0	52491000					100
1.9075	$1s^2 2s^2 2p^3 \ ^2D_{5/2}$	$1s 2s^2 2p^4 \ ^2D_{5/2}$	176130	52601000					100
1.9075	$3/2$	$3/2$	138620	52563000					100
1.9051	$1s^2 2s^2 2p^3 \ ^2P_{3/2}$	$1s 2s^2 2p^4 \ ^2S_{1/2}$	323340	52814000					100
1.9051	$1s^2 2s^2 2p^3 \ ^2D_{5/2}$	$1s 2s^2 2p^4 \ ^2P_{3/2}$	176130	52667000					100

Fe XXI (C Sequence) Ionization Energy = 13620000 cm⁻¹ (1689 eV)

λ (Å)	Classification		Energy Levels (cm ⁻¹)		Int.	f /Type	A (s ⁻¹)	Acc.	References
2298.0	$2s^2 2p^2 \ ^3P_1$	$2s^2 2p^2 \ ^3P_2$	73850	117353		M1	8.46+2	C	116, 117*, 135*
1354.08	0	1	0	73850		M1	6.49+3	C	48, 103, 135*, 172*
786.1	$2s^2 2p^2 \ ^3P_2$	$2s^2 2p^2 \ ^1D_2$	117353	244560		M1	1.51+4	C	117*, 135*
585.8	1	2	73850	244560		M1	1.59+4	C	103, 117*, 135*, 199
270.52	$2s^2 2p^2 \ ^3P_2$	$2s^2 2p^3 \ ^5S_2^o$	117353	486950	6	3.8-4	3.2+7	E	42 ^o Δ, 107*
242.07	1	2	73850	486950	4	5.3-4	3.4+7	E	42 ^o Δ, 107*
259.5 ^c	$2s^2 2p^3 \ ^1P_1^o$	$2p^4 \ ^3P_2$	1261000	1646300		1.9-3	1.1+8	E	107
208.6 ^c	1	1	1261000	1740500		4.8-3	7.3+8	E	107
247.0 ^c	$2s^2 2p^2 \ ^1S_0$	$2s^2 2p^3 \ ^3D_1^o$	371900	776780		1.5-3	5.6+7	E	107
192.49 ^c	$2s^2 2p^3 \ ^1D_2^o$	$2p^4 \ ^3P_2$	1126800	1646300		4.7-3	8.4+8	E	107
162.95 ^c	2	1	1126800	1740500		8.5-4	3.5+8	E	107
187.89 ^c	$2s^2 2p^2 \ ^1D_2$	$2s^2 2p^3 \ ^3D_1^o$	244560	776780		6.4-4	2.0+8	E	107
187.69 ^c	2	2	244560	777350		2.0-4	3.7+7	E	107
178.77 ^c	2	3	244560	803930		7.0-3	1.0+9	E	107
181.57	$2s^2 2p^3 \ ^3S_1^o$	$2p^4 \ ^3P_2$	1095600	1646300	1	5.6-2	6.8+9	C	107*, 146 ^o Δ
156.21	1	0	1095600	1735700	1	2.35-2	1.93+10	C	107*, 146 ^o Δ
155.06	1	1	1095600	1740500	2	5.2-2	1.4+10	C	107*, 146 ^o Δ
180.8 ^c	$2s^2 2p^2 \ ^1S_0$	$2s^2 2p^3 \ ^3P_1^o$	371900	924880		2.4-3	1.7+8	E	107
179.8 ^c	$2s^2 2p^3 \ ^1P_1^o$	$2p^4 \ ^1D_2$	1261000	1817300		4.00-2	5.10+9	C	107
151.65 ^c	$2s^2 2p^2 \ ^3P_2$	$2s^2 2p^3 \ ^3D_1^o$	117353	776780		1.5-4	7.3+7	E	107
151.51	2	2	117353	777350		4.4-5	1.3+7	E	107*, 138 ^c
145.65	2	3	117353	803930	4	2.95-2	6.60+9	C	41, 107*, 138, 146 ^o Δ
142.27	1	1	73850	776780	1	2.4-3	7.9+8	D	107*, 146 ^o Δ
142.16	1	2	73850	777350	6	5.1-2	1.0+10	C	41, 107*, 131, 138, 146 ^o Δ
128.73	0	1	0	776780	5	9.3-2	1.2+10	C	41, 107*, 138, 146 ^o Δ
146.99 ^c	$2s^2 2p^2 \ ^1D_2$	$2s^2 2p^3 \ ^3P_1^o$	244560	924880		5.9-4	3.0+8	E	107
143.32 ^c	2	2	244560	942320		7.5-4	2.4+8	E	107
144.79	$2s^2 2p^3 \ ^1D_2^o$	$2p^4 \ ^1D_2$	1126800	1817300	6	1.12-1	3.56+10	C	107*, 138, 146 ^o Δ
142.05	$2s^2 2p^3 \ ^3P_2^o$	$2p^4 \ ^3P_2$	942320	1646300	5	1.11-2	3.78+9	C	107*, 146 ^o Δ
138.61	1	2	924880	1646300	1	1.84-2	3.92+9	C	107*, 146 ^o Δ
125.29	2	1	942320	1740500	3	2.50-2	1.81+10	C	107*, 146 ^o Δ
123.33	1	0	924880	1735700	2	1.55-2	2.08+10	C	107*, 146 ^o Δ
122.61 ^c	1	1	924880	1740500		3.4-4	1.5+8	E	107
121.36	0	1	916330	1740500	1	3.41-2	5.30+9	C	107*, 146 ^o Δ
138.2 ^c	$2s^2 2p^2 \ ^1S_0$	$2s^2 2p^3 \ ^3S_1^o$	371900	1095600		5.9-3	7.1+8	E	107
127.04	$2s^2 2p^3 \ ^1P_1^o$	$2p^4 \ ^1S_0$	1261000	2048200	3	6.8-2	8.7+10	C	107*, 138, 146 ^o Δ
123.83	$2s^2 2p^2 \ ^3P_2$	$2s^2 2p^3 \ ^3P_1^o$	117353	924880	1	4.4-3	3.2+9	D	107*, 131, 146 ^o Δ
121.21	2	2	117353	942320	8	4.79-2	2.17+10	C	41, 97, 107*, 131, 138, 146 ^o Δ
118.69	1	0	73850	916330	8	1.70-2	2.41+10	C	41, 107*, 138, 146 ^o Δ
117.51	1	1	73850	924880	6	3.54-2	1.70+10	C	41, 107*, 131, 138, 146 ^o Δ
115.15	1	2	73850	942320	4	1.2-3	3.6+8	D	107*, 138, 146 ^o Δ
108.12	0	1	0	924880	2	2.25-2	4.25+9	C	41, 107*, 138, 146 ^o Δ
118.71	$2s^2 2p^3 \ ^3D_3^o$	$2p^4 \ ^3P_2$	803930	1646300	8	4.67-2	3.19+10	C	107*, 146 ^o Δ
115.08	2	2	777350	1646300	3	2.92-2	1.50+10	C	107*, 146 ^o Δ
115.01	1	2	776780	1646300	2	1.25-2	3.85+9	C	107*, 146 ^o Δ
104.29	1	0	776780	1735700	3	2.03-2	3.83+10	C	107*, 146 ^o Δ
103.83	2	1	777350	1740500	4	2.20-2	2.31+10	C	107*, 146 ^o Δ
103.77	1	1	776780	1740500	3	2.52-2	1.58+10	C	107*, 146 ^o Δ

Fe XXI (C Sequence) Ionization Energy = 13620000 cm⁻¹ (1689 eV) — Continued

λ (Å)	Classification	Energy Levels (cm ⁻¹)	Int.	f /Type	A (s ⁻¹)	Acc.	References
117.50 ^c	$2s^2 2p^2 \ ^1D_2$	$2s 2p^3 \ ^3S_1^o$	244560	1095600	3.7-4	2.9+8	E 107
114.30	$2s 2p^3 \ ^3P_2^o$	$2p^4 \ ^1D_2$	942320	1817300	1	4.9-3	E 107*, 146 ^{aΔ}
112.05 ^c	1	2	924880	1817300		4.1-3	E 107
113.30	$2s^2 2p^2 \ ^1D_2$	$2s 2p^3 \ ^1D_2^o$	244560	1126800	10	9.2-2	C 41, 97, 107*, 138, 146 ^{aΔ}
112.47	$2s^2 2p^2 \ ^1S_0$	$2s 2p^3 \ ^1P_1^o$	371900	1261000	4	1.04-1	C 41, 107*, 138, 146 ^{aΔ}
104.98 ^c	$2s 2p^3 \ ^3S_1^o$	$2p^4 \ ^1S_0$	1095600	2048200		3.2-3	E 107
102.22	$2s^2 2p^2 \ ^3P_2$	$2s 2p^3 \ ^3S_1^o$	117353	1095600	7	6.0-2	C 41, 97, 107*, 131, 138, 146 ^{aΔ}
97.88	1	1	73850	1095600	5	3.79-2	C 41, 97, 107*, 131, 138, 146 ^{aΔ}
91.28	0	1	0	1095600	3	3.70-2	C 41, 97, 107*, 138, 146 ^{aΔ}
99.08	$2s^2 2p^2 \ ^3P_2$	$2s 2p^3 \ ^1D_2^o$	117353	1126800	3	1.3-2	D 41, 107*, 146 ^{aΔ}
94.97 ^c	1	2	73850	1126800		9.5-4	E 107
98.69	$2s 2p^3 \ ^3D_3^o$	$2p^4 \ ^1D_2$	803930	1817300	3	6.2-3	E 107*, 146 ^{aΔ}
96.158 ^c	2	2	777350	1817300		1.0-3	E 107
98.36	$2s^2 2p^2 \ ^1D_2$	$2s 2p^3 \ ^1P_1^o$	244560	1261000	9	6.2-2	C 41, 97, 107*, 138, 146 ^{aΔ}
89.022 ^c	$2s 2p^3 \ ^3P_1^o$	$2p^4 \ ^1S_0$	924880	2048200		1.8-3	E 107
87.44 ^c	$2s^2 2p^2 \ ^3P_2$	$2s 2p^3 \ ^1P_1^o$	117353	1261000		1.6-4	E 107
84.26	1	1	73850	1261000	1	5.6-3	E 107*, 146 ^{aΔ}
86.26	$2s 2p^3 \ ^5S_2^o$	$2p^4 \ ^3P_2$	486950	1646300	1	1.6-3	E 107*, 146 ^{aΔ}
79.773 ^c	2	1	486950	1740500		1.6-4	E 107
12.623	$2s^2 2p^2 \ ^1S_0$	$2s^2 2p 3d \ ^1P_1^o$	371900	8293900	45	5.1-1	E 16 ^{aΔ} , 22, 107*
12.58 ^c	$2s^2 2p^2 \ ^1D_2$	$2s^2 2p 3d \ ^3D_3^o$	244560	8195000		3.9-2	E 107
12.525	$2s^2 2p^2 \ ^3P_2$	$2s^2 2p 3d \ ^3F_3^o$	117353	8101400	90	1.9-1	D 16 ^{aΔ} , 22, 107*
12.462	$2s^2 2p^2 \ ^3P_1$	$2s^2 2p 3d \ ^1D_2^o$	73850	8098000	95		16 ^{aΔ} , 22
12.423 ^c	$2s^2 2p^2 \ ^1D_2$	$2s^2 2p 3d \ ^1P_1^o$	244560	8293900		9.5-3	E 107
12.398	$2s^2 2p^2 \ ^3P_1$	$2s^2 2p 3d \ ^3D_1^o$	73850	8140000	120	8.2-2	D 107*, 154, 166 ^{aΔ}
12.38	2	3	117353	8195000		6.9-1	D 73 ^c , 107*
12.325	1	2	73850	8187400	115		16 ^{aΔ} , 22
12.285	0	1	0	8140000	460	1.4	D 73, 107*, 154, 161, 166 ^{aΔ}
12.393	$2s^2 2p^2 \ ^1D_2$	$2s^2 2p 3d \ ^1F_3^o$	244560	8313600	125	1.0	D 16 ^{aΔ} , 22, 73, 76, 107*, 185
12.325	$2s^2 2p^2 \ ^3P_2$	$2s^2 2p 3d \ ^3P_2^o$	117353	8230900	115		16 ^{aΔ} , 22, 73, 76, 161, 185
12.201 ^c	$2s^2 2p^2 \ ^3P_2$	$2s^2 2p 3d \ ^1F_3^o$	117353	8313600		7.0-2	E 107
12.17 ^c	$2s^2 2p^2 \ ^3P_1$	$2s^2 2p 3d \ ^1P_1^o$	73850	8293900		4.0-2	E 107
12.057 ^c	0	1	0	8293900		8.4-2	E 107
9.822 ^c	$2s^2 2p^2 \ ^1S_0$	$2s^2 2p 4d \ ^3D_1^o$	371900	10553000		9.4-3	E 107
9.706 ^c	$2s^2 2p^2 \ ^1D_2$	$2s^2 2p 4d \ ^3F_3^o$	244560	10548000		7.9-3	E 107
9.694 ^c	$2s^2 2p^2 \ ^1S_0$	$2s^2 2p 4d \ ^3P_1^o$	371900	10688000		2.1-3	E 107
9.632	$2s^2 2p^2 \ ^3P_0$	$2s^2 2p 4s \ ^3P_1^o$	0	10380000			90
9.597 ^c	$2s^2 2p^2 \ ^1D_2$	$2s^2 2p 4d \ ^3D_3^o$	244560	10664000		3.3-3	E 107
9.587 ^c	$2s^2 2p^2 \ ^1D_2$	$2s^2 2p 4d \ ^1D_2^o$	244560	10675000		1.4-2	D 107

Fe XXI (C Sequence) Ionization Energy = 13620000 cm⁻¹ (1689 eV)

λ (Å)	Classification		Energy Levels (cm ⁻¹)		Int.	f /Type	A (s ⁻¹)	Acc.	References
9.587	$2s^2 2p^2 \ ^3P_2$	$2s^2 2p 4d \ ^3F_3^o$	117353	10548000	55	6.1-2	3.2+12	D	16 ^a , 20, 90 [*] , 107 [*]
9.583 ^c	$2s^2 2p^2 \ ^3P_2$	$2s^2 2p 4d \ ^3D_1^o$	117353	10553000		7.0-4	8.5+10	E	107
9.542	1	1	73850	10553000		1.1-2	8.1+11	D	90 [*] , 107 [*]
9.482	2	3	117353	10664000	50	9.3-2	4.9+12	D	16 ^a , 20, 90 [*] , 107 [*]
9.548	1	2	73850	10547000	35				16 ^a , 20, 90 [*]
9.476	0	1	0	10553000	35	2.1-1	5.2+12	D	16 ^a , 20, 90 [*] , 107 [*]
9.581	$2s^2 2p^2 \ ^1D_2$	$2s^2 2p 4d \ ^1F_3^o$	244560	10681000	55	1.7-1	8.9+12	D	16 ^a , 20, 107 [*]
9.575 ^c	$2s^2 2p^2 \ ^1D_2$	$2s^2 2p 4d \ ^3P_1^o$	244560	10688000		3.2-3	3.9+11	E	107
9.518	$2s^2 2p^2 \ ^3P_1$	$2s^2 2p 4d \ ^3P_2^o$	73850	10580000	45				16 ^a , 20
9.460 ^c	2	1	117353	10688000		1.2-2	1.5+12	D	107
9.421	1	1	73850	10688000	20	4.4-2	3.3+12	D	16 ^a , 20, 107 [*]
9.472 ^c	$2s^2 2p^2 \ ^3P_2$	$2s^2 2p 4d \ ^1D_2^o$	117353	10675000		8.2-3	6.1+11	E	107
9.433	1	2	73850	10675000	25	3.7-2	1.7+12	D	16 ^a , 20, 107 [*]
8.646 ^c	$2s^2 2p^2 \ ^1D_2$	$2s^2 2p 5d \ ^1D_2^o$	244560	11810000		4.9-3	4.4+11	E	107
8.646 ^c	$2s^2 2p^2 \ ^1D_2$	$2s^2 2p 5d \ ^3P_1^o$	244560	11810000		1.1-3	1.6+11	E	107
8.643	$2s^2 2p^2 \ ^1D_2$	$2s^2 2p 5d \ ^1F_3^o$	244560	11814000	20	6.1-2	3.9+12	D	16 ^a , 20, 107 [*]
8.573	$2s^2 2p^2 \ ^3P_0$	$2s^2 2p 5d \ ^3D_1^o$	0	11665000		7.0-2	2.1+12	D	90 [*] , 107 [*]
8.558	2	3	117353	11802000	20	3.0-2	2.0+12	D	16 ^a , 20, 107 [*]
8.552 ^c	$2s^2 2p^2 \ ^3P_2$	$2s^2 2p 5d \ ^1D_2^o$	117353	11810000		3.1-3	2.8+11	E	107
8.521	1	2	73850	11810000	20	1.1-2	6.1+11	D	16 ^a , 20, 107 [*]
8.552 ^c	$2s^2 2p^2 \ ^3P_2$	$2s^2 2p 5d \ ^3P_1^o$	117353	11810000		4.3-3	6.5+11	E	107
8.521	1	1	73850	11810000	20	1.6-2	1.5+12	D	16 ^a , 20, 107 [*]
1.89692	$1s^2 2s^2 2p^2 \ ^3P_1$	$1s 2s^2 2p^3 \ ^3D_2^o$	73850	52790000	550				100, 175 ^a
1.8966	2	3	117353	52843000					100
1.89474	0	1	0	52777700	420				175
1.8966	$1s^2 2s^2 2p^2 \ ^1S_0$	$1s 2s^2 2p^3 \ ^1P_1^o$	371900	53104000					100
1.8942	$1s^2 2s^2 2p^2 \ ^1D_2$	$1s 2s^2 2p^3 \ ^3P_2^o$	244560	53037000					100
1.8942	$1s^2 2s^2 2p^2 \ ^3P_1$	$1s 2s^2 2p^3 \ ^3S_1^o$	73850	52870000					100
1.89359	$1s^2 2s^2 2p^2 \ ^3P_2$	$1s 2s^2 2p^3 \ ^1D_2^o$	117353	52927100	110				100, 175 ^a
1.8916	$1s^2 2s^2 2p^2 \ ^3P_2$	$1s 2s^2 2p^3 \ ^3P_0^o$	117353	52962000					100
1.8916	1	0	73850	52962000					100
1.8916	$1s^2 2s^2 2p^2 \ ^1D_2$	$1s 2s^2 2p^3 \ ^1P_1^o$	244560	53104000					100

Fe XXII (B Sequence)

Ionization Energy = 14510000 cm⁻¹ (1799 eV)

λ (Å)	Classification		Energy Levels (cm ⁻¹)		Int.	f /Type	A (s ⁻¹)	Acc.	References
845.55	$2s^2 2p^2 \ ^2P_{1/2}^o$	$2s^2 2p^2 \ ^2P_{3/2}^o$	0	118270		M1	1.48+4	C	48, 103, 116 ^o , 117, 135 [*] , 181
379.64 ^c	$2s 2p^2 \ ^2P_{3/2}$	$2p^3 \ ^4S_{3/2}$	992290	1255700		6.7-4	2.8+7	E	107 [*] , 171
248.62 ^c	$1/2$	$3/2$	853480	1255700		2.2-3	1.1+8	E	107
360.39 ^c	$2s 2p^2 \ ^2S_{1/2}$	$2p^3 \ ^4S_{3/2}$	978220	1255700		4.8-4	1.2+7	E	107
349.3	$2s^2 2p^2 \ ^2P_{3/2}^o$	$2s 2p^2 \ ^4P_{1/2}$	118270	404550	6	1.3-4	1.4+7	E	107 [*] , 171 ^Δ
292.46	$3/2$	$3/2$	118270	460200	5	1.1-4	8.2+6	E	107 [*] , 171 ^Δ
253.17	$3/2$	$5/2$	118270	513260	5	1.0-3	6.7+7	E	107 [*] , 171 ^Δ
247.19	$1/2$	$1/2$	0	404550	5	7.9-4	8.4+7	E	41, 107 [*] , 171 ^Δ
217.30	$1/2$	$3/2$	0	460200	1				171
247.45 ^c	$2s 2p^2 \ ^2P_{3/2}$	$2p^3 \ ^2D_{3/2}^o$	992290	1396420		4.0-4	4.4+7	E	107
230.10 ^c	$3/2$	$5/2$	992290	1426880		4.02-2	3.38+9	C	107
184.18 ^c	$1/2$	$3/2$	853480	1396420		6.7-2	6.6+9	C	107
239.12 ^c	$2s 2p^2 \ ^2S_{1/2}$	$2p^3 \ ^2D_{3/2}^o$	978220	1396420		1.46-2	8.6+8	C	107
192.61 ^c	$2s 2p^2 \ ^2D_{3/2}$	$2p^3 \ ^4S_{3/2}$	736520	1255700		7.4-4	1.3+8	E	107
173.21	$2s 2p^2 \ ^2P_{3/2}$	$2p^3 \ ^2P_{1/2}^o$	992290	1569630	1	5.0-3	2.2+9	D	107 [*] , 146 ^Δ
157.37	$3/2$	$3/2$	992290	1627720	4	7.5-2	2.0+10	C	107 [*] , 138, 146 ^Δ
139.64	$1/2$	$1/2$	853480	1569630	1	7.5-3	2.6+9	D	107 [*] , 138, 146 ^Δ
129.17	$1/2$	$3/2$	853480	1627720	1	1.87-2	3.74+9	C	107 [*] , 146 ^Δ
169.08	$2s 2p^2 \ ^2S_{1/2}$	$2p^3 \ ^2P_{1/2}^o$	978220	1569630	1	5.0-2	1.2+10	C	107 [*] , 146 ^Δ
153.96	$1/2$	$3/2$	978220	1627720	1	1.24-2	1.74+9	C	107 [*] , 146 ^Δ
161.74	$2s^2 2p^2 \ ^2P_{3/2}^o$	$2s 2p^2 \ ^2D_{3/2}$	118270	736520	1	1.5-4	3.8+7	E	107 [*] , 131, 146 ^Δ
155.92	$3/2$	$5/2$	118270	759620	4	3.40-2	6.20+9	C	41, 107 [*] , 131, 138, 146 ^Δ
135.78	$1/2$	$3/2$	0	736520	6	6.2-2	1.1+10	C	41, 75, 107 [*] , 131, 138, 146 ^Δ
157.03	$2s 2p^2 \ ^2D_{5/2}$	$2p^3 \ ^2D_{3/2}^o$	759620	1396420	4	1.24-2	5.00+9	C	107 [*] , 138, 146 ^Δ
151.54	$3/2$	$3/2$	736520	1396420	3	2.60-2	7.60+9	C	107 [*] , 146 ^Δ
149.87	$5/2$	$5/2$	759620	1426880	5	4.32-2	1.28+10	C	107 [*] , 138, 146 ^Δ
144.85	$3/2$	$5/2$	736520	1426880	6	1.67-2	3.54+9	C	107 [*] , 138, 146 ^Δ
136.01	$2s^2 2p^2 \ ^2P_{3/2}^o$	$2s 2p^2 \ ^2P_{1/2}$	118270	853480	3	1.6-5	1.2+7	E	107 [*] , 146 ^Δ
117.17	$1/2$	$1/2$	0	853480	7	8.0-2	3.9+10	C	41, 75, 107 [*] , 131, 138, 146 ^Δ
114.41	$3/2$	$3/2$	118270	992290	8	8.8-2	4.5+10	C	41, 46, 75, 107 [*] , 131, 138, 146 ^Δ
100.78	$1/2$	$3/2$	0	992290	4	1.89-2	6.20+9	C	41, 46, 107 [*] , 131, 138, 146 ^Δ
134.65	$2s 2p^2 \ ^4P_{5/2}$	$2p^3 \ ^4S_{3/2}$	513260	1255700	6	3.56-2	1.96+10	C	107 [*] , 138, 146 ^Δ
125.71	$3/2$	$3/2$	460200	1255700	6	3.60-2	1.52+10	C	107 [*] , 138, 146 ^Δ
117.52	$1/2$	$3/2$	404550	1255700	6	4.28-2	1.03+10	C	107 [*] , 138, 146 ^Δ
120.03	$2s 2p^2 \ ^2D_{3/2}$	$2p^3 \ ^2P_{1/2}^o$	736520	1569630	8	3.20-2	2.96+10	C	107 [*] , 146 ^Δ
115.19	$5/2$	$3/2$	759620	1627720	4	1.89-2	1.42+10	C	107 [*] , 146 ^Δ
112.21	$3/2$	$3/2$	736520	1627720	2	9.7-3	5.1+9	D	107 [*] , 146 ^Δ
116.28	$2s^2 2p^2 \ ^2P_{3/2}^o$	$2s 2p^2 \ ^2S_{1/2}$	118270	978220	6	3.58-2	3.53+10	C	107 [*] , 138, 146 ^Δ
102.23	$1/2$	$1/2$	0	978220	7	4.2-3	2.7+9	D	41, 107 [*] , 131, 138, 146 ^Δ
113.23 ^c	$2s 2p^2 \ ^4P_{5/2}$	$2p^3 \ ^2D_{3/2}^o$	513260	1396420		2.8-4	2.3+8	E	107
109.53	$5/2$	$5/2$	513260	1426880	3	3.5-3	2.0+9	E	107 [*] , 146 ^Δ
106.8 ^c	$3/2$	$3/2$	460200	1396420		3.9-3	2.4+9	E	107
103.4 ^c	$3/2$	$5/2$	460200	1426880		1.2-4	5.1+7	E	107
100.82 ^c	$1/2$	$3/2$	404550	1396420		1.0-4	3.4+7	E	107
89.730 ^c	$2s 2p^2 \ ^4P_{5/2}$	$2p^3 \ ^2P_{3/2}^o$	513260	1627720		1.2-4	1.5+8	E	107
85.831 ^c	$1/2$	$1/2$	404550	1569630		2.5-4	2.3+8	E	107
85.65 ^c	$3/2$	$3/2$	460200	1627720		3.2-4	3.0+8	E	107

Fe XXII (B Sequence) Ionization Energy = 14510000 cm⁻¹ (1799 eV) — Continued

λ (Å)	Classification		Energy Levels (cm ⁻¹)		Int.	f /Type	A (s ⁻¹)	Acc.	References
14.56 ^c	$2p^3 \ ^2P_{3/2}^{\circ}$	$2s^2 3d \ ^2D_{3/2}$	1627720	8498000		1.8-3	5.9+10	E	107
14.54 ^c	$3/2$	$5/2$	1627720	8507000		1.3-2	3.0+11	D	107
14.43 ^c	$1/2$	$3/2$	1569630	8498000		1.7-2	2.9+11	D	107
12.52 ^c	$2s 2p^2 \ ^2S_{1/2}$	$2s 2p(^3P^{\circ}) 3d \ ^2P_{1/2}^{\circ}$	978220	8967000		3.5-1	1.5+13	D	107
12.193	$1/2$	$3/2$	978220	9180000	70				16 ^a , 25
12.325	$2s 2p^2 \ ^2P_{1/2}$	$2s 2p(^3P^{\circ}) 3d \ ^2P_{1/2}^{\circ}$	853480	8967000	115				16 ^a , 25
12.01 ^c	$1/2$	$3/2$	853480	9180000	70	3.2-1	7.2+12	D	107
12.26 ^c	$2s 2p^2 \ ^2S_{1/2}$	$2s 2p(^1P^{\circ}) 3d \ ^2D_{3/2}^{\circ}$	978220	9134000	80	4.4-1	1.0+13	D	16 ^a , 25, 107*
12.21 ^c	$2s 2p^2 \ ^2S_{1/2}$	$2s 2p(^1P^{\circ}) 3d \ ^2P_{3/2}^{\circ}$	978220	9168000	70	3.0-1	6.9+12	D	107
12.193	$2s 2p^2 \ ^2D_{3/2}$	$2s 2p(^3P^{\circ}) 3d \ ^2D_{5/2}^{\circ}$	736520	8938000	70	3.3-1	9.9+12	D	16 ^a , 25, 107*
12.095	$2s 2p^2 \ ^2D_{5/2}$	$2s 2p(^3P^{\circ}) 3d \ ^2F_{5/2}^{\circ}$	759620	9030000	90	1.7-1	7.8+12	D	16 ^a , 25, 36, 107*
12.053	$3/2$	$5/2$	736520	9030000	60	2.0-1	6.1+12	D	16 ^a , 25, 36, 76, 107*, 185
12.045	$5/2$	$7/2$	759620	9062000	150	7.1-1	2.4+13	D	16 ^a , 25, 76, 107*, 185
12.077	$2s 2p^2 \ ^2P_{1/2}$	$2s 2p(^1P^{\circ}) 3d \ ^2D_{3/2}^{\circ}$	853480	9134000	95	3.5-1	8.2+12	D	16 ^a , 25, 107*
12.077	$3/2$	$5/2$	992290	9272000	95	7.8-1	2.4+13	D	16 ^a , 25, 76, 107*, 185
12.027	$2s 2p^2 \ ^2P_{1/2}$	$2s 2p(^1P^{\circ}) 3d \ ^2P_{3/2}^{\circ}$	853480	9168000	70				16 ^a , 25
11.976	$2s 2p^2 \ ^4P_{5/2}$	$2s 2p(^3P^{\circ}) 3d \ ^4F_{7/2}^{\circ}$	513260	8864000	125	1.7-1	5.9+12	D	16 ^a , 25, 107*, 179
11.935	$2s^2 2p \ ^2P_{3/2}^{\circ}$	$2s^2 3d \ ^2D_{3/2}$	118270	8498000		6.4-2	3.0+12	D-	16, 36, 107*, 161, 166 ^c
11.921	$3/2$	$5/2$	118270	8507000	120	5.9-1	1.8+13	D	16 ^a , 25, 29, 36, 73, 107*, 154, 179, 185
11.767	$1/2$	$3/2$	0	8498000	100	6.6-1	1.6+13	D	16 ^a , 25, 29, 36, 73, 107*, 154, 161, 166, 179, 185
11.886	$2s 2p^2 \ ^4P_{3/2}$	$2s 2p(^3P^{\circ}) 3d \ ^4P_{5/2}^{\circ}$	460200	8874000	90	4.2-1	1.3+13	D	16 ^a , 25, 107*
11.823	$5/2$	$3/2$	513260	8972000	90	1.1-1	7.9+12	D	16 ^a , 25, 107*, 179
11.748	$3/2$	$1/2$	460200	8973000	130	1.9-1	1.8+13	D	16 ^a , 25, 107*
11.748	$3/2$	$3/2$	460200	8972000	130	2.5-1	1.2+13	D	16 ^a , 25, 107*
11.837	$2s 2p^2 \ ^4P_{5/2}$	$2s 2p(^3P^{\circ}) 3d \ ^4D_{7/2}^{\circ}$	513260	8962000	135	6.5-1	2.3+13	D	16 ^a , 25, 76, 107*, 179, 185
11.837	$5/2$	$5/2$	513260	8973000	135	3.5-1	1.7+13	D	16 ^a , 25, 107*, 179
11.797	$1/2$	$3/2$	404550	8882000	130	7.0-1	1.7+13	D	16 ^a , 25, 107*
11.789	$1/2$	$1/2$	404550	8888000	130	5.5-1	2.6+13	D	16 ^a , 25, 107*, 179
11.748	$3/2$	$5/2$	460200	8973000	130	1.5-1	4.8+12	D	16 ^a , 25, 107*
11.789	$2s 2p^2 \ ^2D_{5/2}$	$2s 2p(^1P^{\circ}) 3d \ ^2F_{7/2}^{\circ}$	759620	9242000	130	3.2-1	1.2+13	D	16 ^a , 25, 76, 107*, 179, 185
11.748	$3/2$	$5/2$	736520	9249000	130	4.9-1	1.6+13	D	16 ^a , 25, 107*
11.669	$2s^2 2p \ ^2P_{3/2}^{\circ}$	$2s 2p 3p \ ^2P_{3/2}$	118270	8688000	60				16 ^a , 25, 76, 179, 185
11.650	$1/2$	$1/2$	0	8584000	30				16 ^a , 25, 76, 185
11.459	$2s^2 2p \ ^2P_{3/2}^{\circ}$	$2s 2p 3p \ ^2D_{5/2}$	118270	8845000	60				16 ^a , 25, 76, 154, 179, 185
11.442	$1/2$	$3/2$	0	8740000	180				16 ^a , 25, 76, 154, 185
10.513 ^c	$2p^3 \ ^2P_{3/2}^{\circ}$	$2s^2 4d \ ^2D_{5/2}$	1627720	11140000		2.4-3	1.0+11	E	107
10.513 ^c	$3/2$	$3/2$	1627720	11140000		2.7-4	1.7+10	E	107
10.449 ^c	$1/2$	$3/2$	1569630	11140000		3.0-3	9.6+10	E	107
9.241	$2s 2p^2 \ ^2D_{3/2}$	$2s 2p(^3P^{\circ}) 4d \ ^2F_{5/2}^{\circ}$	736520	11558000	45	9.8-2	5.1+12	D	16 ^a , 25, 107*
8.977	$5/2$	$7/2$	759620	11900000	25	4.0-2	2.5+12	D	16 ^a , 25, 107*
9.215	$2s 2p^2 \ ^2D_{5/2}$	$2s 2p(^3P^{\circ}) 4d \ ^2D_{5/2}^{\circ}$	759620	11611000	35	3.5-2	2.7+12	D	16 ^a , 25, 107*
9.183	$2s 2p^2 \ ^2D_{5/2}$	$2s 2p(^1P^{\circ}) 4d \ ^2F_{7/2}^{\circ}$	759620	11649000	60	1.4-1	8.3+12	D	16 ^a , 25, 107*
8.960	$3/2$	$5/2$	736520	11897000	45	6.8-2	3.8+12	D	16 ^a , 25, 107*
9.163	$2s 2p^2 \ ^2P_{3/2}$	$2s 2p(^1P^{\circ}) 4d \ ^2D_{5/2}^{\circ}$	992290	11906000	30	1.3-1	6.9+12	D	16 ^a , 25, 107*

Fe XXII (B Sequence)

Ionization Energy = 14510000 cm⁻¹ (1799 eV) — Continued

λ (Å)	Classification		Energy Levels (cm ⁻¹)		Int.	f /Type	A (s ⁻¹)	Acc.	References
9.14	$2s^2 2p^2 P_{3/2}^{\circ}$	$2s^2 4s^2 S_{1/2}$	118270	11050000		4.0-3	6.4+11	E	16, 29, 107*, 179°, 185
9.06	$1/2$	$1/2$	0	11050000		4.1-3	3.3+11	E	16, 29, 107*, 179°, 185
9.073	$2s^2 2p^2 P_{3/2}^{\circ}$	$2s^2 4d^2 D_{5/2}$	118270	11140000	40	1.1-1	6.0+12	D	16 ^Δ , 25, 29, 90°, 107*, 179
9.073	$3/2$	$3/2$	118270	11140000		1.2-2	9.9+11	D-	90°, 107*
8.976	$1/2$	$3/2$	0	11140000	45	1.2-1	5.0+12	D	16 ^Δ , 25, 29, 90°, 107*, 161, 179
9.065	$2s 2p^2 4P_{3/2}$	$2s 2p(^3P^{\circ}) 4d^4 F_{5/2}^{\circ}$	460200	11492000	40	6.5-2	3.5+12	D	16 ^Δ , 25, 107*
9.006	$2s 2p^2 4P_{5/2}$	$2s 2p(^3P^{\circ}) 4d^4 D_{7/2}^{\circ}$	513260	11618000	50	9.3-2	5.7+12	D	16 ^Δ , 25, 107*
9.006	$5/2$	$5/2$	513260	11618000	50	6.5-2	5.3+12	D	16 ^Δ , 25, 107*
8.992	$1/2$	$3/2$	404550	11526000	35	1.2-1	4.9+12	D	16 ^Δ , 25, 107*
8.722	$2s^2 2p^2 P_{1/2}$	$2s 2p(^3P^{\circ}) 4p^2 P_{1/2}^{\circ}$	0	11465000					90
8.715	$2s^2 2p^2 P_{1/2}$	$2s 2p(^3P^{\circ}) 4p^2 D_{3/2}^{\circ}$	0	11474000					90
8.091	$2s^2 2p^2 P_{1/2}$	$2s 2p 5d^2 D_{3/2}^{\circ}$	0	12359000					90
1.8867	$1s^2 2s^2 2p^2 P_{3/2}^{\circ}$	$1s 2s^2 2p^2 P_{1/2}$	118270	53122000					100
1.8824	$3/2$	$3/2$	118270	53242000					100
1.8824	$1/2$	$1/2$	0	53122000					100
1.88534	$1s^2 2s^2 2p^2 P_{3/2}^{\circ}$	$1s 2s^2 2p^2 D_{5/2}$	118270	53166000	1030				100, 175 ^Δ
1.88259	$1/2$	$3/2$	0	53124000	1310				100, 175 ^Δ
1.8794	$1s^2 2s^2 2p^2 P_{3/2}^{\circ}$	$1s 2s^2 2p^2 S_{1/2}$	118270	53327000					100

Fe XXIII (Be Sequence)

Ionization Energy = 15730000 cm⁻¹ (1950 eV)

λ (Å)	Classification		Energy Levels (cm ⁻¹)		Int.	f /Type	A (s ⁻¹)	Acc.	References
1079.3	$2s2p\ ^3P_1^o$	$2s2p\ ^3P_2^o$	379130	471780		M1			103, 117°
602.4°	$2s3p\ ^1P_1^o$	$2s3d\ ^1D_2$	9107000	9273000		4.7-2	5.1+8	E	107
492.0°	$2s2p\ ^1P_1^o$	$2p^2\ ^3P_0$	752840	956100		2.8-4	2.1+7	E	107
364.48°	1	1	752840	1027200		1.5-4	7.0+6	E	107
313.62°	1	2	752840	1071700		9.0-3	3.5+8	D	107
263.76	$2s^2\ ^1S_0$	$2s2p\ ^3P_1^o$	0	379130		1.5-3	4.8+7	D	41, 107*, 115, 171, 197°
221.33	$2s2p\ ^1P_1^o$	$2p^2\ ^1D_2$	752840	1204200	5	5.64-2	4.54+9	B	107*, 146° ^a
180.10	$2s2p\ ^3P_2^o$	$2p^2\ ^3P_1$	471780	1027200	1	1.30-2	4.51+9	B	107*, 146° ^a
173.31	1	0	379130	956100	2	1.85-2	1.24+10	B	107*, 146° ^a
166.74	2	2	471780	1071700	4	3.16-2	7.65+9	B	107*, 146° ^a
154.27	1	1	379130	1027200	2	1.49-2	4.19+9	B	107*, 146° ^a
147.24	0	1	348180	1027200	3	6.43-2	6.62+9	B	107*, 146° ^a
144.36	1	2	379130	1071700	4	2.83-2	5.46+9	B	107*, 146° ^a
149.22	$2s2p\ ^1P_1^o$	$2p^2\ ^1S_0$	752840	1423000	3	3.64-2	3.28+10	B	107*, 146° ^a
136.53	$2s2p\ ^3P_2^o$	$2p^2\ ^1D_2$	471780	1204200	4	1.35-2	4.94+9	C	107*, 146° ^a
121.20°	1	2	379130	1204200		1.6-3	4.4+8	D	107
132.83	$2s^2\ ^1S_0$	$2s2p\ ^1P_1^o$	0	752840	10	1.55-1	1.95+10	B	41, 75, 107*, 115, 131, 146° ^a , 197°
36.09°	$2s3d\ ^1D_2$	$2s4p\ ^1P_1^o$	9273000	12044000		1.5-2	1.3+11	D	107
33.43°	$2s3p\ ^1P_1^o$	$2s4d\ ^1D_2$	9107000	12098000		5.6-1	2.0+12	C	107
13.01°	$2p^2\ ^1S_0$	$2s3p\ ^1P_1^o$	1423000	9107000		1.1-2	1.4+11	D	108
12.65°	$2p^2\ ^1D_2$	$2s3p\ ^1P_1^o$	1204200	9107000		2.4-3	1.7+11	D	108
12.427	$2p^2\ ^1S_0$	$2p3s\ ^1P_1^o$	1423000	9470000	105				15, 16° ^a , 36
12.095	$2p^2\ ^1D_2$	$2p3s\ ^1P_1^o$	1204200	9470000	90				15, 16° ^a
12.095	$2p^2\ ^3P_1$	$2p3s\ ^3P_0^o$	1027200	9295000	90				15, 16° ^a
11.898	$2p^2\ ^1S_0$	$2p3d\ ^1P_1^o$	1423000	9828000	80	1.3	2.1+13	D	15, 16° ^a , 25, 107*, 179
11.737	$2s2p\ ^1P_1^o$	$2s3d\ ^1D_2$	752840	9273000	145	5.9-1	1.7+13	D	15, 16° ^a , 25, 36, 76, 78, 107*, 166, 185
11.692	$2p^2\ ^3P_2$	$2p3d\ ^3F_3^o$	1071700	9625000	115	2.2-1	7.7+12	D	15, 16° ^a , 25, 78, 107*, 179
11.614	$2p^2\ ^3P_1$	$2p3d\ ^3D_1^o$	1027200	9637000	85				15, 16° ^a
11.525	2	3	1071700	9749000	125	6.4-1	2.3+13	D	15, 16° ^a , 25, 76, 78, 107*, 179, 185
11.519	0	1	956100	9637000	115	1.4	2.4+13	D	15, 16° ^a , 25, 29, 36, 78, 107*, 179, 185
11.614	$2p^2\ ^3P_1$	$2p3d\ ^1D_2^o$	1027200	9638000	85				15, 16° ^a , 25, 78, 179
11.594	$2p^2\ ^1D_2$	$2p3d\ ^1F_3^o$	1204200	9830000	140	9.9-1	3.5+13	D	15, 16° ^a , 25, 29, 36, 76, 78, 107*, 179, 185
11.594	$2p^2\ ^1D_2$	$2p3d\ ^1P_1^o$	1204200	9828000	140				15, 16° ^a , 36
11.519	$2p^2\ ^3P_2$	$2p3d\ ^3P_2^o$	1071700	9753000	155	2.3-1	1.2+13	E	15, 16° ^a , 25, 29, 78, 107*
11.459	1	2	1027200	9753000	60				15, 16° ^a , 78
11.493	$2p^2\ ^3P_1$		1027200	9728000	45				15, 16° ^a , 25, 36, 78, 179, 185

Fe XXIII (Be Sequence) Ionization Energy = 15730000 cm⁻¹ (1950 eV) — Continued

λ (Å)	Classification	Energy Levels (cm ⁻¹)	Int.	f /Type	A (s ⁻¹)	Acc.	References	
11.45 ^c	$2s2p\ ^3P_2^o$	$2s3d\ ^3D_2$	471780	9209000		1.1-1	5.4+12	D- 107
11.442	2	3	471780	9212000	180	6.0-1	2.2+13	C+ 15, 16 ^a , 25, 36, 73, 78, 107*, 161
11.34 ^c	1	1	379130	9199000		1.8-1	9.3+12	D- 107
11.325	1	2	379130	9209000	110	5.6-1	1.7+13	D 15, 16 ^a , 25, 76, 78, 107*, 179, 185
11.298	0	1	348180	9199000	45	7.7-1	1.3+13	D 15, 16 ^a , 25, 29, 78, 107*, 179
11.399	$2s2p\ ^1P_1^o$	$2p3p\ ^1P_1$	752840	9526000	30			15, 16 ^a
11.166	$2s2p\ ^1P_1^o$	$2p3p\ ^1D_2$	752840	9709000	60	2.1-1	6.8+12	D 15, 16 ^a , 25, 107*, 179
11.018	$2s^2\ ^1S_0$	$2s3p\ ^3P_1^o$	0	9076000	90			15, 16 ^a , 25, 78, 154
11.018	$2s2p\ ^3P_1^o$	$2p3p\ ^3D_1$	379130	9455000	100			15, 16 ^a
10.980	0	1	348180	9455000	55			15, 16 ^a , 179
10.935	1	2	379130	9524000	60	1.5-1	5.0+12	D 15, 16 ^a , 25, 78, 107*, 179
10.927	2	3	471780	9624000	95	1.3-1	5.2+12	D 15, 16 ^a , 25, 76, 78, 107*, 179, 185
10.980	$2s^2\ ^1S_0$	$2s3p\ ^1P_1^o$	0	9107000	55	6.20-2	1.14+13	B 15, 16 ^a , 25, 36, 73, 78, 107*, 154, 161, 166, 179
10.903	$2s2p\ ^3P_2^o$	$2p3p\ ^3P_2$	471780	9644000	75	8.8-2	4.9+12	D 15, 16 ^a , 25, 78, 107*, 179
10.826	$2s2p\ ^3P_2^o$	$2p3p\ ^1D_2$	471780	9709000	35			15, 16 ^a
8.906	$2s2p\ ^1P_1^o$	$2s4s\ ^1S_0$	752840	11981000		6.4-3	1.6+12	D 90°, 107*
8.815	$2s2p\ ^1P_1^o$	$2s4d\ ^1D_2$	752840	12098000	35	1.2-1	6.2+12	D 16 ^a , 25, 29, 78, 90°, 107*
8.763	$2p^2\ ^3P_2$	$2p4d\ ^3F_3^o$	1071700	12484000	30	7.4-2	4.6+12	D 16 ^a , 25, 78, 107*
8.752	$2p^2\ ^1D_2$	$2p4d\ ^1F_3^o$	1204200	12631000	40	1.9-1	1.2+13	D 16 ^a , 25, 78, 107*
8.731	$2p^2\ ^3P_1$		1027200	12480000	35			16 ^a , 25, 78
8.672	$2p^2\ ^3P_0$	$2p4d\ ^3D_2^o$	956100	12488000	60	2.3-1	6.8+12	D 16 ^a , 25, 107*
8.672	2	3	1071700	12603000	60	9.6-2	6.1+12	D 16 ^a , 25, 78, 107*
8.664	$2p^2\ ^3P_2$	$2p4d\ ^3P_2^o$	1071700	12614000	35			16 ^a , 25
8.630	1	1	1027200	12615000	25	5.0-2	4.5+12	D 16 ^a , 25, 107*
8.643	$2p^2\ ^3P_1$	$2p4d\ ^1D_2^o$	1027200	12597000	20			16 ^a , 25, 29, 78
8.616	$2s2p\ ^3P_2^o$	$2s4d\ ^3D_3$	471780	12081000	45	1.1-1	7.1+12	D 16 ^a , 25, 29, 78, 90°, 107*
8.550	1	2	379130	12075000	40	9.7-2	5.3+12	D 16 ^a , 25, 29, 78, 90°, 107*
8.529	0	1	348180	12073000	25	1.3-1	4.0+12	D 16 ^a , 25, 29, 78, 107*
8.317	$2s^2\ ^1S_0$	$2s4p\ ^3P_1^o$	0	12024000		3.6-2	1.2+12	E 78, 90°, 107*
8.305	$2s^2\ ^1S_0$	$2s4p\ ^1P_1^o$	0	12044000	30	1.54-1	4.97+12	B 16 ^a , 25, 29, 44, 78, 90°, 100, 107*, 154, 174
8.289	$2s2p\ ^3P_1^o$	$2p4p\ ^3D_2$	379130	12443000				78
8.273	2	3	471780	12560000	40	3.8-2	2.6+12	D 16 ^a , 25, 78, 107*
7.883	$2s2p\ ^1P_1^o$	$2s5d\ ^1D_2$	752840	13438000	30	4.3-2	2.8+12	D 16 ^a , 25, 107*
7.854	$2p^2\ ^3P_2$	$2p5d\ ^3F_3^o$	1071700	13804000	30	3.0-2	2.3+12	D 16 ^a , 25, 107*
7.849	$2p^2\ ^1D_2$	$2p5d\ ^1F_3^o$	1204200	13945000	35	6.4-2	4.9+12	D 16 ^a , 25, 107*
7.826	$2p^2\ ^3P_1$	$2p5d\ ^3D_2^o$	1027200	13805000	15	4.0-2	2.6+12	D 16 ^a , 25, 107*
7.778	2	3	1071700	13929000	30	3.2-2	2.5+12	D 16 ^a , 25, 107*

Fe XXIII (Be Sequence)

Ionization Energy = 15730000 cm⁻¹ (1950 eV)

λ (Å)	Classification		Energy Levels (cm ⁻¹)		Int.	<i>f</i> /Type	<i>A</i> (s ⁻¹)	Acc.	References
7.755	$2p^2\ ^3P_1$	$2p5d\ ^1D_2$	1027200	13922000	25				16 [°] _A , 25
7.733	$2s2p\ ^3P_2^o$	$2s5d\ ^3D_3$	471780	13404000	15	3.8-2	3.0+12	D	16 [°] _A , 25, 107*
7.680	o	1	348180	13369000	20	4.7-2	1.8+12	D	16 [°] _A , 25, 107*
7.680	1	2	379130	13400000	20	3.7-2	2.5+12	D	16 [°] _A , 25, 107*
7.472	$2s^2\ ^1S_0$	$2s5p\ ^1P_1^o$	0	13383000	20	6.3-2	2.5+12	D	16 [°] _A , 25, 107*
7.445	$2s2p\ ^3P_2^o$	$2p5p\ ^3D_3$	471780	13904000	30	1.8-2	1.5+12	D	16 [°] _A , 25, 107*
1.88706	$1s^22s2p\ ^3P_2^o$	$1s(^2S)2s2p^2(^4P)\ ^5P_3$	471780	53464000	260				175
1.87973	$1s^22s^2\ ^1S_0$	$1s2s^22p\ ^3P_1^o$	0	53199100	330				175
1.87814	$1s^22s2p\ ^1P_1^o$	$1s(^2S)2s2p^2(^2D)\ ^1D_2$	752840	54045000	330				140, 175 [°] _A
1.87568	$1s^22s2p\ ^3P_2^o$	$1s(^2S)2s2p^2(^2D)\ ^3D_3$	471780	53786000	1800				173, 175 [°] _A
1.8752	2	1	471780	53800000					140
1.87363	1	2	379130	53751000	2140				173, 175 [°] _A
1.87242	1	1	379130	53800000	1690				173, 175 [°] _A
1.8752	$1s^22s2p\ ^3P_1^o$	$1s(^2S)2s2p^2(^4P)\ ^3P_0$	379130	53707000					140
1.8714	$1s^22s2p\ ^1P_1^o$	$1s(^2S)2s2p^2(^2P)\ ^1P_1$	752840	54182000					140
1.8708	$1s^22s2p\ ^3P_2^o$	$1s(^2S)2s2p^2(^2S)\ ^3S_1$	471780	53925000					140
1.87051	$1s^22s^2\ ^1S_0$	$1s2s^22p\ ^1P_1^o$	0	53464000	2250				100, 113, 173, 175 [°] _A
1.8692	$1s^22s2p\ ^1P_1^o$	$1s(^2S)2s2p^2(^2S)\ ^1S_0$	752840	54252000					140
1.8588	$1s^22s2p\ ^3P_1^o$	$1s(^2S)2s2p^2(^2P)\ ^1P_1$	379130	54182000					140

Fe XXIV (Li Sequence) Ionization Energy = 16320000 cm⁻¹ (2023 eV)

λ (Å)	Classification	Energy Levels (cm ⁻¹)	Int.	f /Type	A (s ⁻¹)	Acc.	References		
255.10	$1s^2 2s^2 S_{1/2}$	$1s^2 2p^2 P_{1/2}^o$	0	392000	9	1.77-2	1.81+9	B+	107*, 115, 171 ^A , 196*, 198
192.04	$1/2$	$3/2$	0	520720	9	4.78-2	4.32+9	B+	107*, 115, 171 ^A , 196*, 198
69.493 ^c	$1s^2 4p^2 P_{3/2}^o$	$1s^2 5d^2 D_{3/2}$	12522000	13961000		5.8-2	8.0+10	D	107
69.300 ^c	$3/2$	$5/2$	12522000	13965000		5.23-1	4.83+11	C+	107
68.729 ^c	$1/2$	$3/2$	12506000	13961000		5.90-1	4.19+11	C+	107
45.188 ^c	$1s^2 4p^2 P_{3/2}^o$	$1s^2 6d^2 D_{3/2}$	12522000	14735000		1.4-2	4.6+10	D	107
45.106 ^c	$3/2$	$5/2$	12522000	14739000		1.27-1	2.76+11	C+	107
44.863 ^c	$1/2$	$3/2$	12506000	14735000		1.42-1	2.37+11	C+	107
37.216 ^c	$1s^2 4p^2 P_{3/2}^o$	$1s^2 7d^2 D_{5/2}$	12522000	15209000		5.54-2	1.77+11	C+	107
37.216 ^c	$3/2$	$3/2$	12522000	15209000		6.1-3	2.9+10	D	107
36.996 ^c	$1/2$	$3/2$	12506000	15209000		6.20-2	1.51+11	C+	107
32.000 ^c	$1s^2 3p^2 P_{3/2}^o$	$1s^2 4d^2 D_{3/2}$	9417000	12542000		6.0-2	3.9+11	C+	107
31.959 ^c	$3/2$	$5/2$	9417000	12546000		5.5-1	2.4+12	B	107
31.606 ^c	$1/2$	$3/2$	9378000	12542000		6.3-1	2.1+12	B	107
30.925 ^c	$1s^2 3s^2 S_{1/2}$	$1s^2 4p^2 P_{1/2}^o$	9272400	12506000		1.5-1	1.0+4	C	107
30.773 ^c	$1/2$	$3/2$	9272400	12522000		3.0-1	1.1+12	C	107
22.007 ^c	$1s^2 3p^2 P_{3/2}^o$	$1s^2 5d^2 D_{3/2}$	9417000	13961000		1.4-2	1.9+11	D	107
21.988 ^c	$3/2$	$5/2$	9417000	13965000		1.24-1	1.14+12	C+	107
21.820 ^c	$1/2$	$3/2$	9378000	13961000		1.39-1	9.73+11	C+	107
18.804 ^c	$1s^2 3p^2 P_{3/2}^o$	$1s^2 6d^2 D_{3/2}$	9417000	14735000		5.7-3	1.1+11	D	107
18.790 ^c	$3/2$	$5/2$	9417000	14739000		5.01-2	6.30+11	C+	107
18.667 ^c	$1/2$	$3/2$	9378000	14735000		5.58-2	5.32+11	C+	107
17.265 ^c	$1s^2 3p^2 P_{3/2}^o$	$1s^2 7d^2 D_{5/2}$	9417000	15209000		2.59-2	3.84+11	C+	107
17.265 ^c	$3/2$	$3/2$	9417000	15209000		2.9-3	6.4+10	D	107
17.150 ^c	$1/2$	$3/2$	9378000	15209000		2.90-2	3.31+11	C+	107
11.426	$1s^2 2p^2 P_{3/2}^o$	$1s^2 3s^2 S_{1/2}$	520720	9272400	125	1.76-2	1.80+12	C	16 ^A , 78, 107*, 154
11.261	$1/2$	$1/2$	392000	9272400	60	1.5-2	7.9+11	D	16 ^A , 78, 107*, 154
11.187	$1s^2 2p^2 P_{3/2}^o$	$1s^2 3d^2 D_{3/2}$	520720	9459000	40	6.8-2	3.6+12	B	16 ^A , 78, 107*, 179
11.171	$3/2$	$5/2$	520720	9472000	185	6.11-1	2.18+13	B	16 ^A , 29, 73, 78, 107*, 154, 161, 166, 179
11.030	$1/2$	$3/2$	392000	9459000	120	6.70-1	1.84+13	B	16 ^A , 29, 73, 78, 107*, 154, 161, 179
10.663	$1s^2 2s^2 S_{1/2}$	$1s^2 3p^2 P_{1/2}^o$	0	9378000	80	1.28-1	7.51+12	B+	16 ^A , 29, 73, 78, 107*, 154, 161, 179
10.619	$1/2$	$3/2$	0	9417000	105	2.46-1	7.28+12	B+	16 ^A , 29, 73, 78, 107*, 154, 161, 179
8.3757	$1s^2 2p^2 P_{3/2}^o$	$1s^2 4s^2 S_{1/2}$	520720	12464000	20	3.6-3	6.9+11	D	16 ^A , 43, 78, 107*, 174°
8.2854	$1/2$	$1/2$	392000	12464000	25	3.7-3	3.6+11	D	16 ^A , 29, 43, 107*, 174°
8.317	$1s^2 2p^2 P_{3/2}^o$	$1s^2 4d^2 D_{3/2}$	520720	12542000		1.22-2	1.18+12	C	90°, 107*
8.3160	$3/2$	$5/2$	520720	12546000	60	1.10-1	7.07+12	C+	16 ^A , 29, 43, 78, 90, 100, 107*, 154, 161, 174°
8.232	$1/2$	$3/2$	392000	12542000	35	1.24-1	6.10+12	C+	16 ^A , 29, 43, 78, 90°, 107*
7.996	$1s^2 2s^2 S_{1/2}$	$1s^2 4p^2 P_{1/2}^o$	0	12506000	25	3.3-2	3.4+12	C+	16 ^A , 78, 90°, 107*, 161
7.986	$1/2$	$3/2$	0	12522000	35	6.55-2	3.43+12	C+	16 ^A , 29, 78, 90°, 107*, 161
7.438	$1s^2 2p^2 P_{3/2}^o$	$1s^2 5d^2 D_{3/2}$	520720	13961000	35	4.5-3	5.4+11	D	16 ^A , 107*
7.438	$3/2$	$5/2$	520720	13965000	35	4.05-2	3.26+12	C	16 ^A , 29, 107*, 161
7.370	$1/2$	$3/2$	392000	13961000	25	4.6-2	2.8+12	C	16 ^A , 29, 107*, 161
7.169	$1s^2 2s^2 S_{1/2}$	$1s^2 5p^2 P_{1/2}^o$	0	13949000	20	1.3-2		C	16°, 108*
7.169	$1/2$	$3/2$	0	13949000	20	2.7-2		C	16°, 108*

Fe XXIV (Li Sequence) Ionization Energy = 16320000 cm⁻¹ (2023 eV) — Continued

λ (Å)	Classification		Energy Levels (cm ⁻¹)		Int.	f /Type	A (s ⁻¹)	Acc.	References
7.035 ^c	1s ² 2p ² P _{3/2}	1s ² 6d ² D _{3/2}	520720	14735000		2.2-3	2.9+11	D	107
7.033			520720	14739000	15	1.98-2	1.78+12	C+	16 ^a , 107*
6.972			392000	14735000		2.22-2	1.52+12	C+	16 ^a , 107*, 161
6.808	1s ² 2p ² P _{3/2}	1s ² 7d ² D _{5/2}	520720	15209000		1.13-2	1.08+12	C+	16*, 107*
6.808			520720	15209000		1.2-3	1.8+11	D	16*, 107*
6.749 ^c			392000	15209000		1.27-2	9.28+11	C+	107
6.787	1s ² 2s ² S _{1/2}	1s ² 6p ² P _{1/2}	0	14734000		1.41-2		D	16*, 108*
6.787			0	14734000		7.1-3		D	16*, 108*
1.89692	1s ² 2p ² P _{3/2}	1s2s ² ² S _{1/2}	520720	53235600	55	2.5-3	9.4+12	D+	107*, 175°
1.89244			392000	53235600	45	5.1-3	9.5+12	D+	107*, 175°
1.8767	1s ² 2p ² P _{3/2}	1s2p ² ⁴ P _{1/2}	520720	53806000		5.3-5	2.0+11	E	107*, 140°
1.8739			520720	53877000		4.3-3	8.1+12	D	107*, 140°
1.8721			392000	53806000		1.0-2	1.9+13	D	107*, 140°
1.8721			520720	53937000		2.6-2	3.3+13	D	107*, 140°
1.8700			392000	53877000		1.4-4	1.3+11	E	107*, 140°
1.87466	1s ² 2s ² S _{1/2}	1s(² S)2s2p(³ P°) ⁴ P _{1/2}	0	53287900		2.6-3	4.9+12	D+	107*, 173°
1.8730			0	53390000		1.6-2	1.5+13	D+	107*, 140°
1.8678	1s ² 2p ² P _{3/2}	1s2p ² ² D _{3/2}	520720	54070000		1.6-2	3.0+13	D	107*, 140°
1.86598			520720	54126000	430	1.64-1	2.10+14	C	12, 100, 107*, 113, 140, 173, 175 ^a
1.86328			392000	54070000	410	3.26-1	3.13+14	C	12, 100, 107*, 140, 173, 175 ^a
1.8672	1s ² 2p ² P _{3/2}	1s2p ² ² P _{1/2}	520720	54077000		4.10-2	1.57+14	C	107*, 140°
1.8627 ^c			392000	54077000		2.8-1	5.4+14	C	107
1.86224			520720	54244000	110	3.2-1	6.2+14	C	12, 107*, 140, 173, 175 ^a
1.858			392000	54244000	14	1.3-2	1.3+13	D	107*, 113 ^a
1.86345	1s ² 2s ² S _{1/2}	1s(² S)2s2p(³ P°) ² P _{1/2}	0	53657000	10	1.01-1	1.96+14	C	12, 100, 107*, 113 ^a , 140, 173°
1.86108			0	53752000	285	4.5-3	4.4+12	E	12, 100, 107*, 113, 140, 173, 175 ^a
1.8580	1s ² 3d ² D _{3/2}	1s2p(³ P°)3d ⁴ D _{3/2}	9459000	63281000					140
1.85704	1s ² 2s ² S _{1/2}	1s(² S)2s2p(¹ P°) ² P _{1/2}	0	53844000	190	1.53-1	2.93+14	C	12, 100, 107*, 113, 140, 173, 175 ^a
1.8552			0	53903000		4.92-1	4.74+14	C	107*, 140°
1.85691	1s ² 2p ² P _{3/2}	1s2p ² ² S _{1/2}	520720	54385000		6.30-2	2.44+14	C	107*, 140, 173°
1.8523			392000	54385000	20	4.5-3	8.8+12	D	107*, 113 ^a , 140°
1.85592	1s ² 3d ² D _{5/2}	1s2p3d ² F _{7/2}	9472000	63618000					140, 173°
1.8540	1s ² 3s ² S _{1/2}	1s2p3s ² P _{3/2}	9272400	63209000					140
1.85349	1s ² 3p ² P _{3/2}	1s2p3p ² D _{5/2}	9417000	63543000					13, 140, 173°
1.85273			9378000	63352000					173
1.8464	1s ² 3p ² P _{3/2}	1s2p3p ² S _{1/2}	9417000	63572000					140
1.8453			9378000	63572000					140
1.5960									136
1.5926									136
1.588									136

Fe xxv (He Sequence) Ionization Energy = 71200000 cm⁻¹ (8828 eV)

λ (Å)	Classification		Energy Levels (cm ⁻¹)		Int. <i>f</i> /Type	<i>A</i> (s ⁻¹)	Acc.	References
6756.8°	1s5s ³ S ₁	1s5p ³ P ₁ ^o	68423800	68438600	2.9-2	4.2+6	E	108
6024.1°	1s5s ¹ S ₀	1s5p ¹ P ₁ ^o	68438100	68454700	9.9-2	6.1+6	E	108
3430.5°	1s4s ³ S ₁	1s4p ³ P ₁ ^o	66846900	66876050	2.3-2	1.3+7	E	108
3086.4°	1s4s ¹ S ₀	1s4p ¹ P ₁ ^o	66875100	66907500	7.8-2	1.9+7	D	108
1448.0°	1s3s ³ S ₁	1s3p ³ P ₁ ^o	63421670	63490730	1.6-2	5.1+7	C	108
1301.1°	1s3s ¹ S ₀	1s3p ¹ P ₁ ^o	63488900	63565760	5.6-2	7.4+7	C	108
428.08°	1s2s ³ S ₁	1s2p ³ P ₀ ^o	53527650	53761250	3.47-3	3.82+8	B	107
400.37°	1	1	53527650	53777420	1.03-2	4.31+8	B	107
271.19°	1	2	53527650	53896390	2.73-2	1.47+9	B	26, 107*
382.73°	1s2s ¹ S ₀	1s2p ¹ P ₁ ^o	53781140	54042420	3.29-2	4.96+8	B	107
194.26°	1s2s ³ S ₁	1s2p ¹ P ₁ ^o	53527650	54042420	1.97-3	3.46+8	B	107
65.334°	1s4p ¹ P ₁ ^o	1s5s ¹ S ₀	66907500	68438100	5.5-2	2.6+11	B	107
64.610°	1s4p ³ P ₁ ^o	1s5s ³ S ₁	66876050	68423800	5.3-2	8.5+10	B	107
63.307°	1s4s ¹ S ₀	1s5p ¹ P ₁ ^o	66875100	68454700	4.46-1	2.48+11	B	107
62.826°	1s4s ³ S ₁	1s5p ³ P ₁ ^o	66846900	68438600	1.50-1	2.53+11	B	107
30.218°	1s3p ¹ P ₁ ^o	1s4s ¹ S ₀	63565760	66875100	3.4-2	7.4+11	B	107
30.021°	1s3d ¹ D ₂	1s4p ¹ P ₁ ^o	63576490	66907500	1.1-2	1.4+11	C	108
29.883°	1s3p ¹ P ₁ ^o	1s4d ¹ D ₂	63565760	66912100	6.2-1	2.8+12	C	108
29.796°	1s3p ³ P ₁ ^o	1s4s ³ S ₁	63490730	66846900	3.3-2	2.5+11	B	107
29.252°	1s3s ¹ S ₀	1s4p ¹ P ₁ ^o	63488900	66907500	4.00-1	1.04+12	B	107
28.949°	1s3s ³ S ₁	1s4p ³ P ₁ ^o	63421670	66876050	1.35-1	1.07+12	B	107
20.524°	1s3p ¹ P ₁ ^o	1s5s ¹ S ₀	63565760	68438100	7.7-3	3.7+11	C	107
20.271°	1s3p ³ P ₁ ^o	1s5s ³ S ₁	63490730	68423800	7.3-3	1.2+11	C	107
20.138°	1s3s ¹ S ₀	1s5p ¹ P ₁ ^o	63488900	68454700	1.03-1	5.65+11	B	107
19.933°	1s3s ³ S ₁	1s5p ³ P ₁ ^o	63421670	68438600	3.4-2	5.7+11	B	107
10.586°	1s2p ¹ P ₁ ^o	1s3s ¹ S ₀	54042420	63488900	1.4-2	2.5+12	B	107
10.489°	1s2p ¹ P ₁ ^o	1s3d ¹ D ₂	54042420	63576490	7.0-1	2.5+13	C+	29, 109*
10.369°	1s2p ³ P ₁ ^o	1s3s ³ S ₁	53777420	63421670	1.4-2	8.7+11	B	107
10.220°	1s2s ¹ S ₀	1s3p ¹ P ₁ ^o	53781140	63565760	3.64-1	7.75+12	B	107
10.037°	1s2s ³ S ₁	1s3p ³ P ₁ ^o	53527650	63490730	1.22-1	8.08+12	B	107
7.7926°	1s2p ¹ P ₁ ^o	1s4s ¹ S ₀	54042420	66875100	3.1-3	1.0+12	C	107
7.7702°	1s2p ¹ P ₁ ^o	1s4d ¹ D ₂	54042420	66912100	1.2-1	8.0+12	C	29, 109*
7.6514°	1s2p ³ P ₁ ^o	1s4s ³ S ₁	53777420	66846900	3.1-3	3.5+11	C	107
7.6183°	1s2s ¹ S ₀	1s4p ¹ P ₁ ^o	53781140	66907500	8.8-2	3.4+12	B	107

Fe XXV (He Sequence) Ionization Energy = 71200000 cm⁻¹ (8828 eV) — Continued

λ (Å)	Classification		Energy Levels (cm ⁻¹)		Int. f /Type	A (s ⁻¹)	Acc.	References
7.4915 ^c	1s2s ³ S ₁	1s4p ³ P ₁ ^o	53527650	66876050	3.0-2	3.6+12	B	107
6.9465 ^c	1s2p ¹ P ₁ ^o	1s5s ¹ S ₀	54042420	68438100	1.2-3	5.0+11	C	107
6.8276 ^c	1s2p ³ P ₁ ^o	1s5s ³ S ₁	53777420	68423800	1.2-3	1.7+11	C	107
6.8150 ^c	1s2s ¹ S ₀	1s5p ¹ P ₁ ^o	53781140	68454700	3.6-2	1.7+12	B	107
6.7065 ^c	1s2s ³ S ₁	1s5p ³ P ₁ ^o	53527650	68438600	1.2-2	1.8+12	B	107
1.8682 ^c	1s ² ¹ S ₀	1s2s ³ S ₁	0	53527650				5, 100, 113, 160, 173, 175, 82, 190
1.8595 ^c	1s ² ¹ S ₀	1s2p ³ P ₁ ^o	0	53777420	6.87-2	4.42+13	B	5, 100, 107*, 113, 140, 148, 160, 173, 175, 182, 190
1.8554 ^c	0	2	0	53896390	E2			5, 100, 113, 173, 175, 182, 190
1.8504 ^c	1s ² ¹ S ₀	1s2p ¹ P ₁ ^o	0	54042420	7.03-1	4.57+14	B	5, 100, 107*, 113, 140, 148, 159, 160, 173, 175, 182, 190
1.5750 ^c	1s ² ¹ S ₀	1s3p ³ P ₁ ^o	0	63490730	1.7-2	1.5+13	E	107*, 136
1.5732 ^c	1s ² ¹ S ₀	1s3p ¹ P ₁ ^o	0	63565760	1.38-1	1.24+14	B	107*, 136, 159, 160
1.4953 ^c	1s ² ¹ S ₀	1s4p ³ P ₁ ^o	0	66876050	6.0-3	6.0+12	E	107
1.4946 ^c	1s ² ¹ S ₀	1s4p ¹ P ₁ ^o	0	66907500	5.07-2	5.05+13	B	107*, 159, 160
1.4612 ^c	1s ² ¹ S ₀	1s5p ³ P ₁ ^o	0	68438600	3.0-3	3.1+12	E	107
1.4608 ^c	1s ² ¹ S ₀	1s5p ¹ P ₁ ^o	0	68454700	2.44-2	2.54+13	B	107*, 159

Fe XXVI (H Sequence) Ionization Energy = 74829600 cm⁻¹ (9277.76 eV)

λ (Å)	Classification		Energy Levels (cm ⁻¹)		Int. f /Type	A (s ⁻¹)	Acc.	References
9.6745 ^c	2p ² P _{3/2} ^o	3d ² D _{5/2}	56242454	66578899	6.958-1	2.954+13	A	200
9.5361 ^c	2s ² S _{1/2}	3p ² P _{3/2} ^o	56075896	66562365	4.349-1	1.026+13	A	200
7.1712 ^c	2p ² P _{3/2} ^o	4d ² D _{5/2}	56242454	70187104	1.218-1	9.423+13	A	200
7.0901 ^c	2s ² S _{1/2}	4p ² P _{3/2} ^o	56075896	70180124	1.028-1	4.418+12	A	200
6.4037 ^c	2p ² P _{3/2} ^o	5d ² D _{5/2}	56242454	71858361	4.437-2	4.307+12	A	200
6.3376 ^c	2s ² S _{1/2}	5p ² P _{3/2} ^o	56075896	71854788	4.193-2	2.261+12	A	200
1.7834 ^c	1s ² S _{1/2}	2p ² P _{1/2} ^o	0	56071350	4.162-1	2.863+14	A	5, 159, 190, 200*
1.7780 ^c	1/2	3/2	0	56242454	4.162-1	2.863+14	A	5, 159, 190, 200*
1.5035 ^c	1s ² S _{1/2}	3p ² P _{1/2} ^o	0	66511637	7.910-2	7.641+13	A	200
1.5024 ^c	1s ² S _{1/2}	3/2	0	66562365	7.910-2	7.641+13	A	200
1.4249 ^c	1s ² S _{1/2}	4p ² P _{3/2} ^o	0	70180124	2.899-2	3.116+13	A	200
1.3917 ^c	1s ² S _{1/2}	5p ² P _{3/2} ^o	0	71854788	1.394-2	1.571+13	A	200

5. Explanation of Grotrian Diagrams

Notations on the Diagrams generally have the same meanings as for the Tables (see Explanation of Tables).

Abscissa

Energy of the levels in cm^{-1} .

Short vertical lines

Energy levels are indicated by the vertical lines. The electronic configuration (with the parentage in parentheses) and the level energy in cm^{-1} are given to the right of the vertical line, and at the top is the J value. Energy levels for the same upper term are grouped together. The term des-

ignation is given at the right of the diagram; the ordering is by increasing multiplicity and orbital angular momentum. For the lower level, the term is adjacent to the configuration.

Horizontal lines

Transitions between levels. The number below each line gives the transition wavelength in Angstroms (10^{-8}cm). Heavier lines indicate resonance transitions with absorption oscillator strengths $f \geq 0.01$.

Limit

Principal ionization limit in cm^{-1} (eV).

6. Grotrian Diagrams for Fe VIII-Fe xxvi

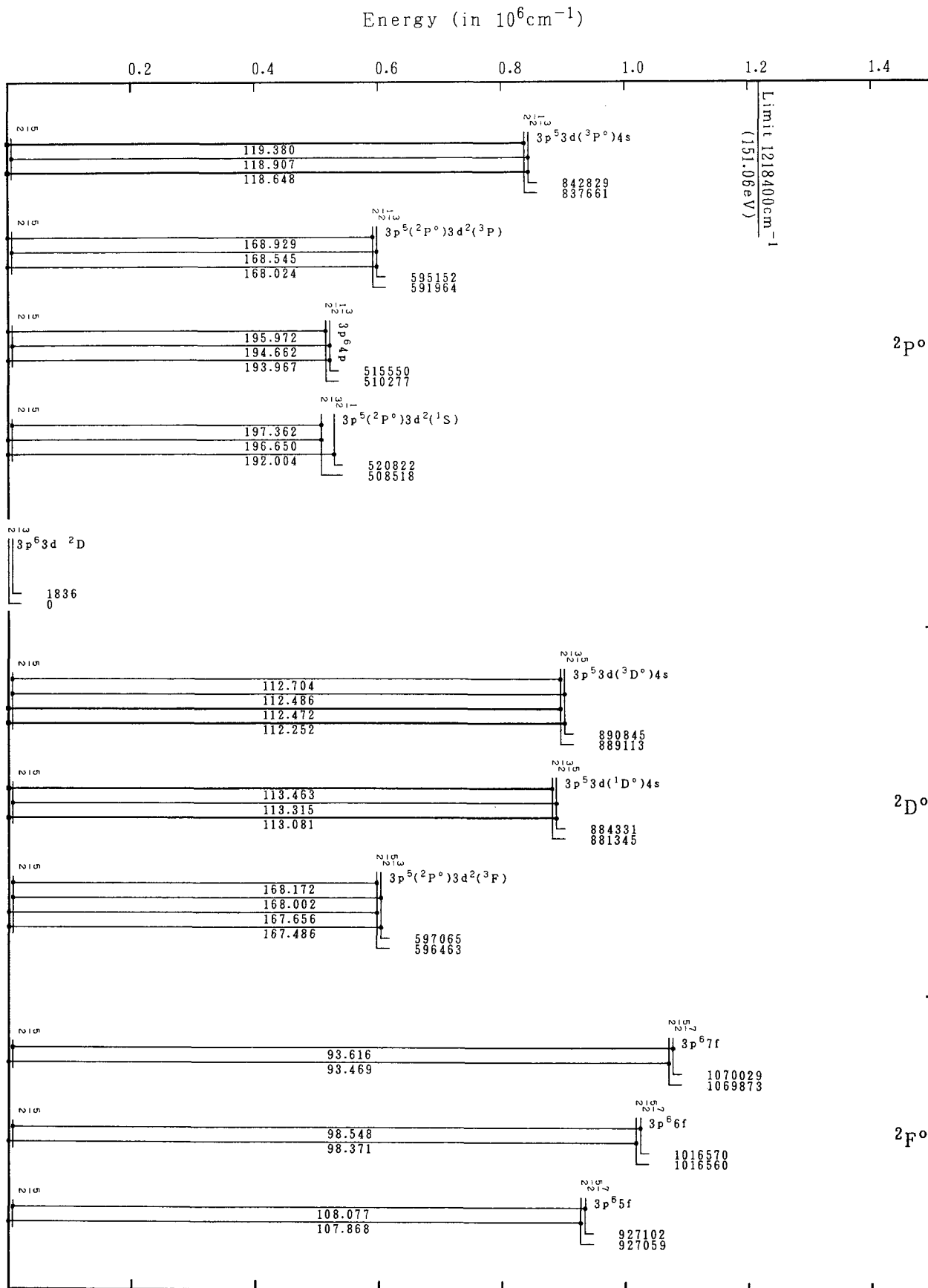

Grotrian Diagrams for Fe VIII (K-Sequence)

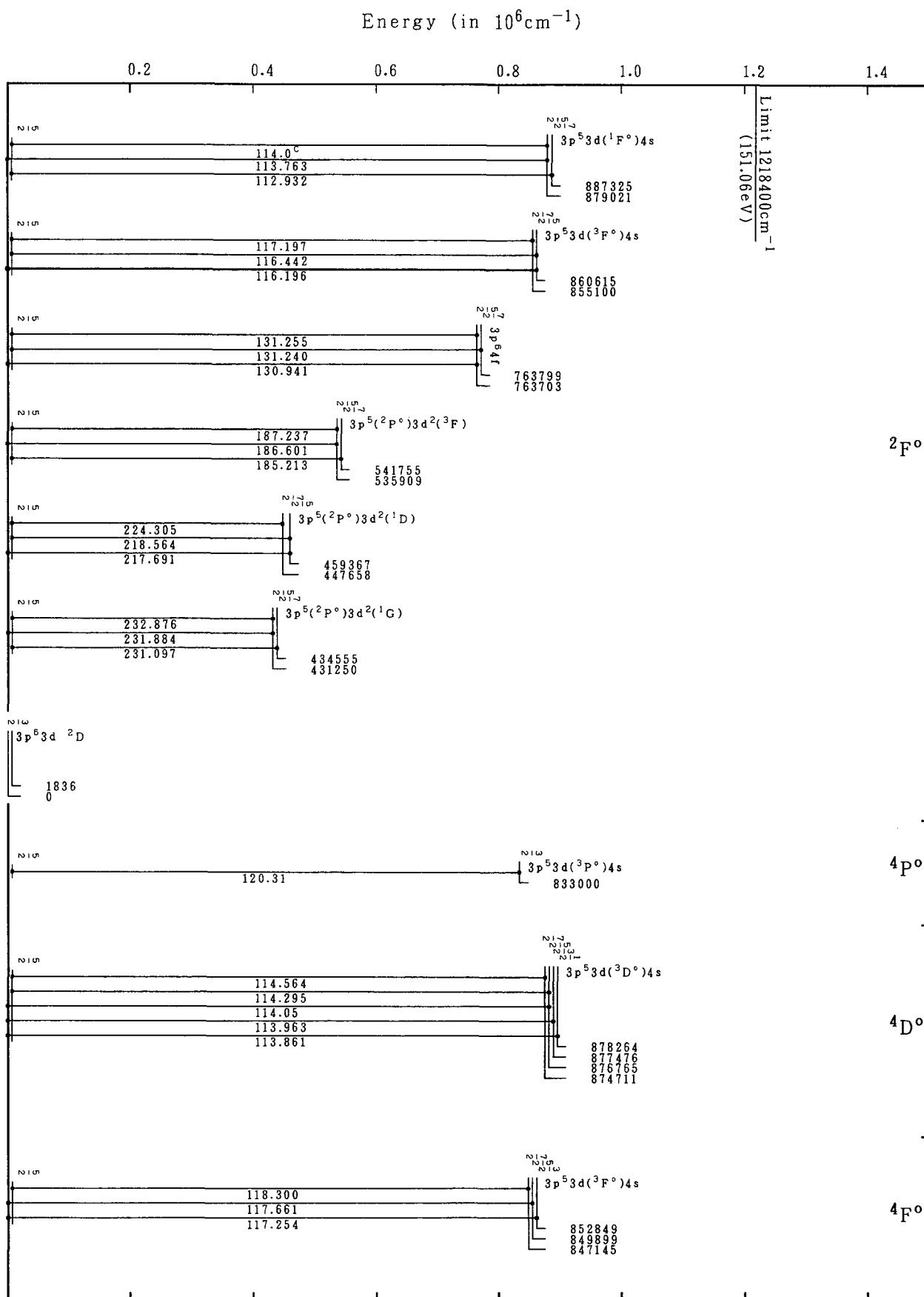

Grotrian Diagrams for Fe VIII (K-Sequence)-Continued

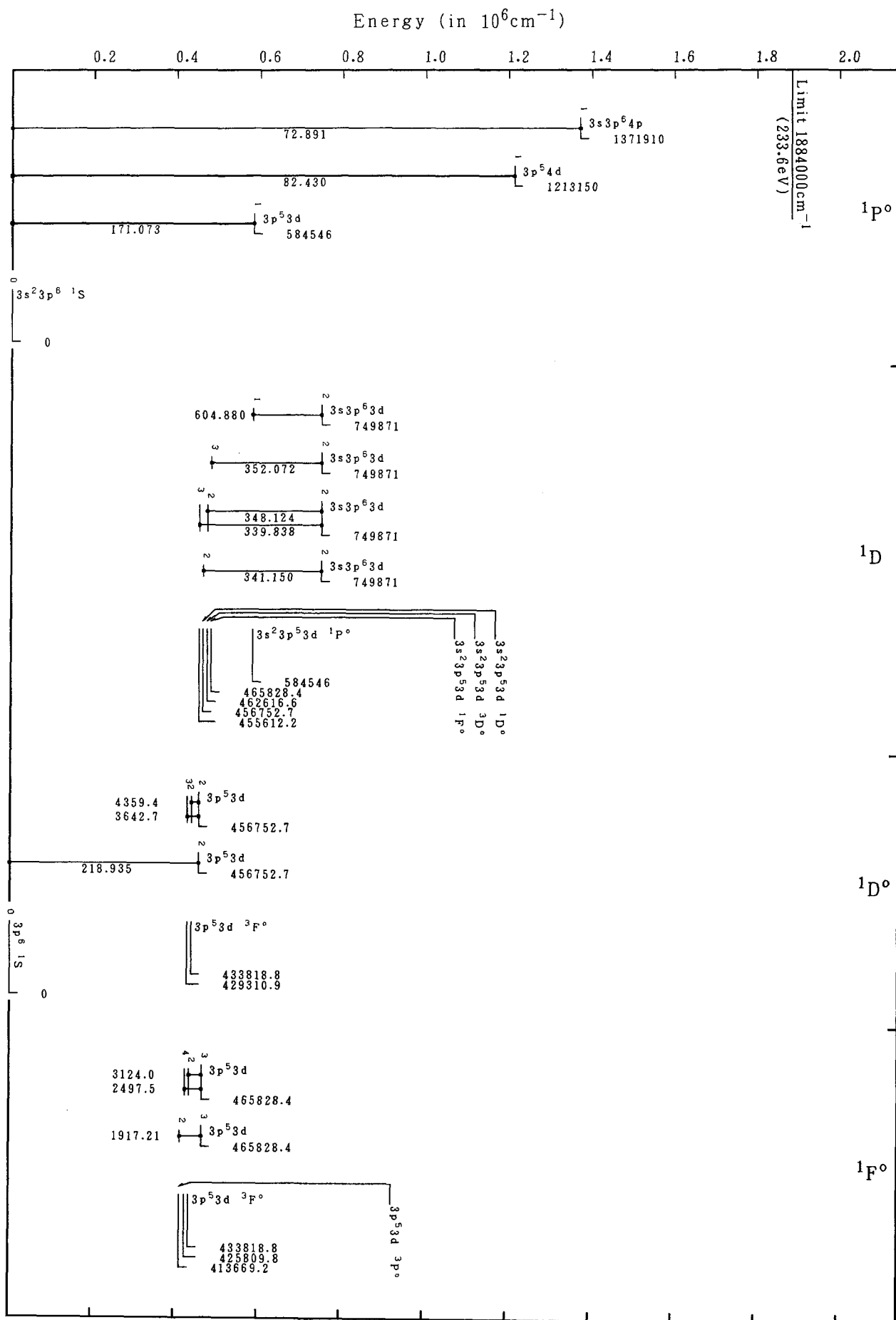

Grotrian Diagrams for Fe IX (Ar-Sequence)

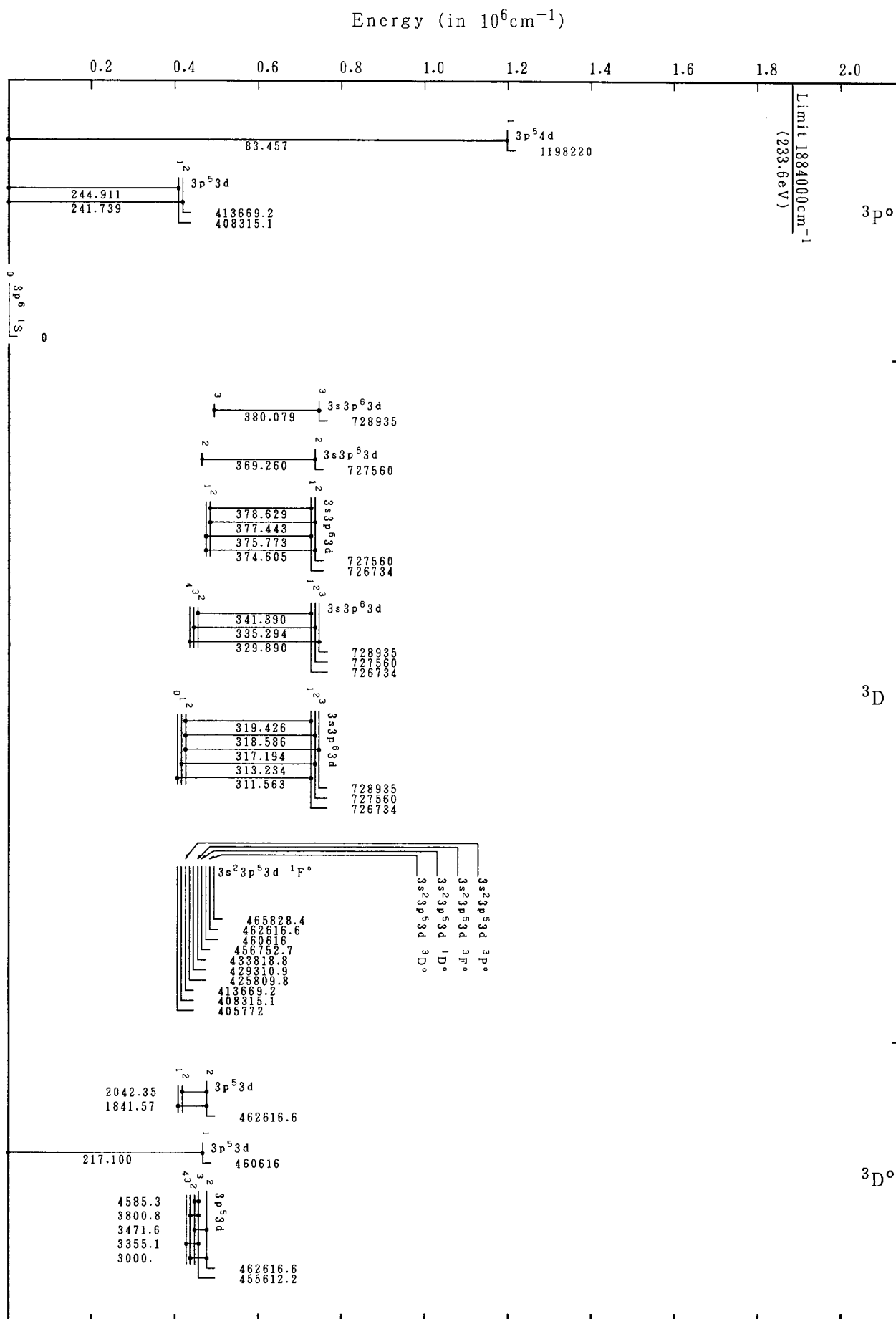

Grotrian Diagrams for Fe IX (Ar-Sequence)-Continued

Energy (in 10^6cm^{-1})

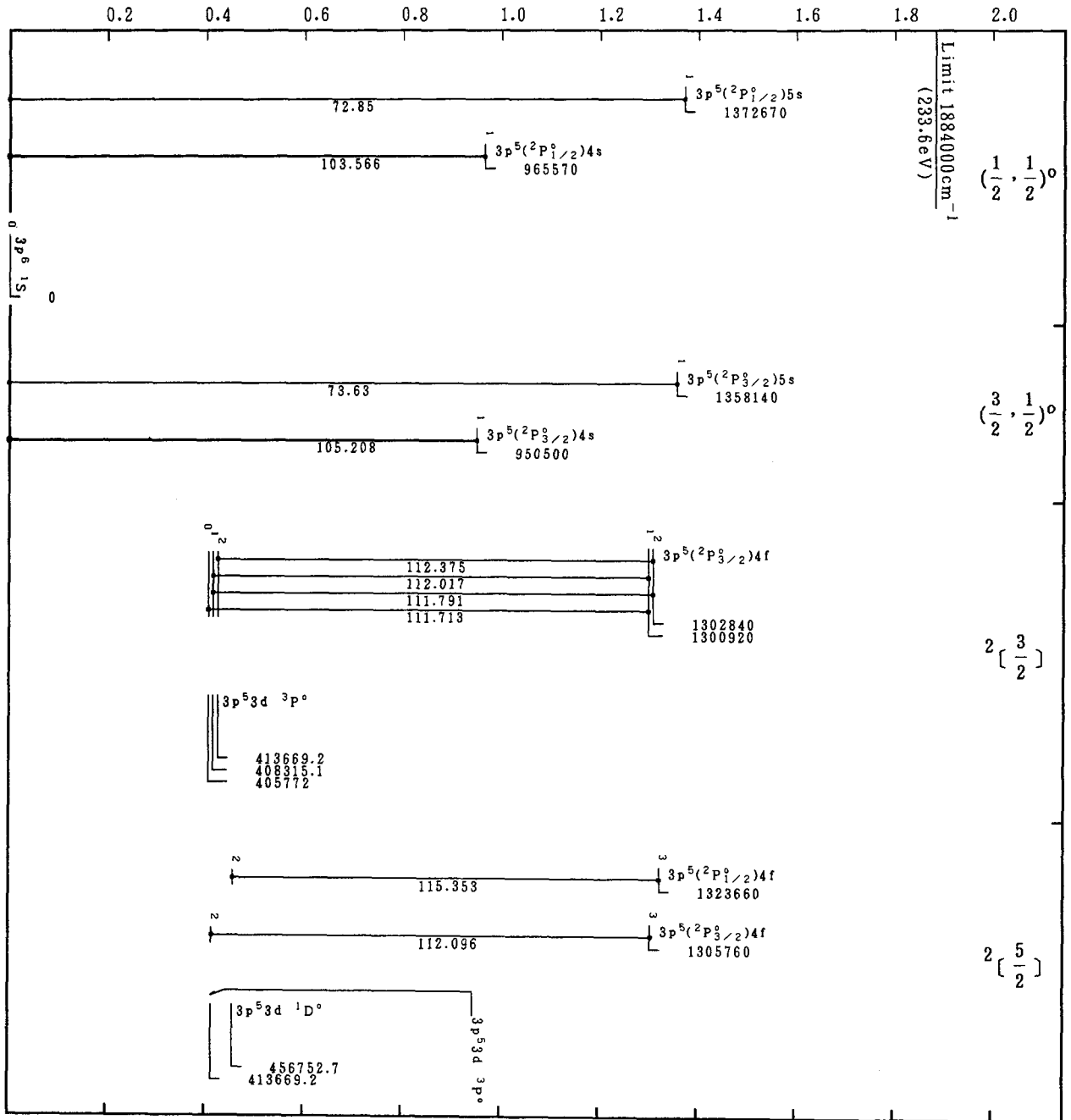

Grotrian Diagrams for Fe IX (Ar-Sequence)-Continued

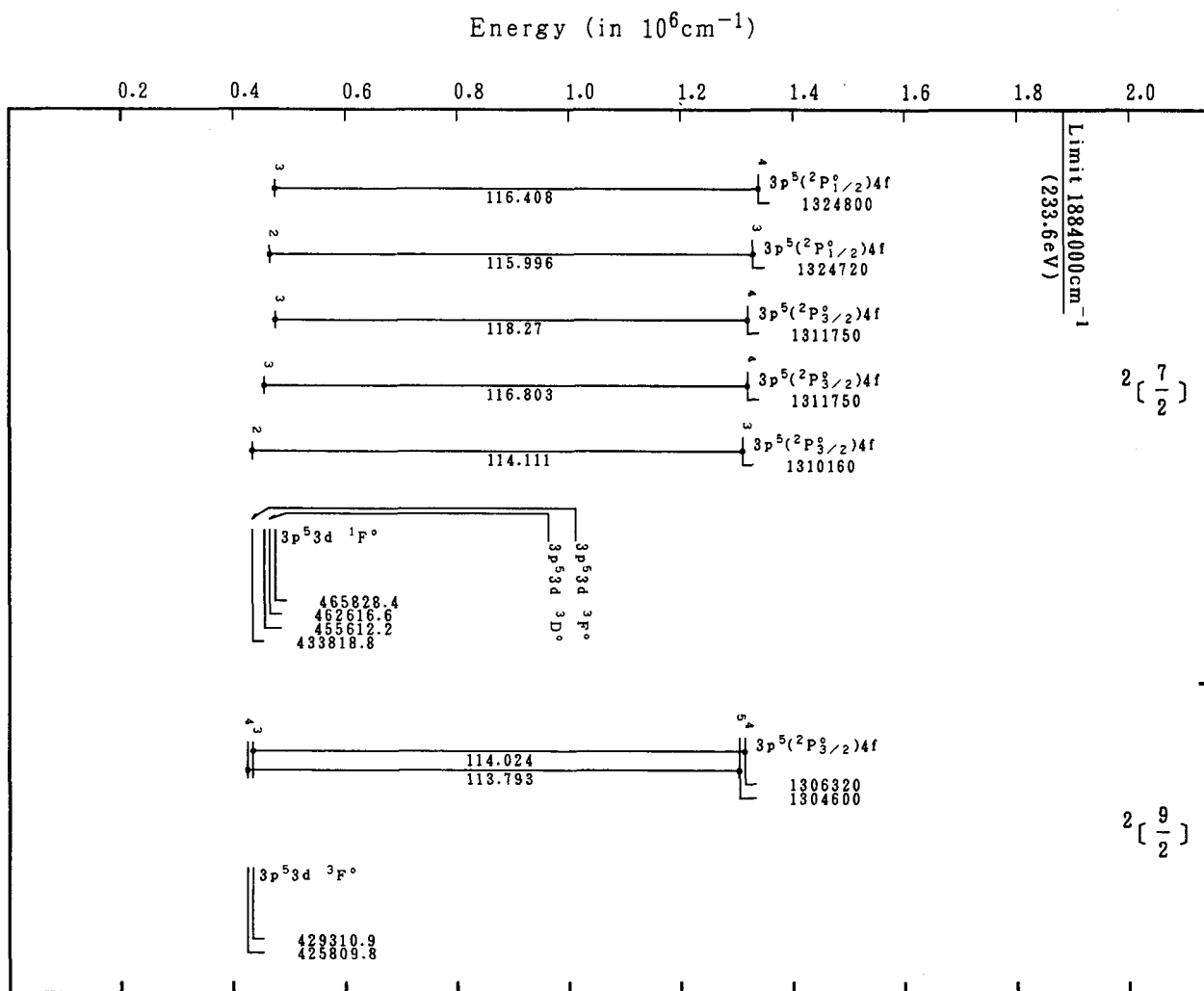

Grotrian Diagrams for Fe IX (Ar-Sequence)-Continued

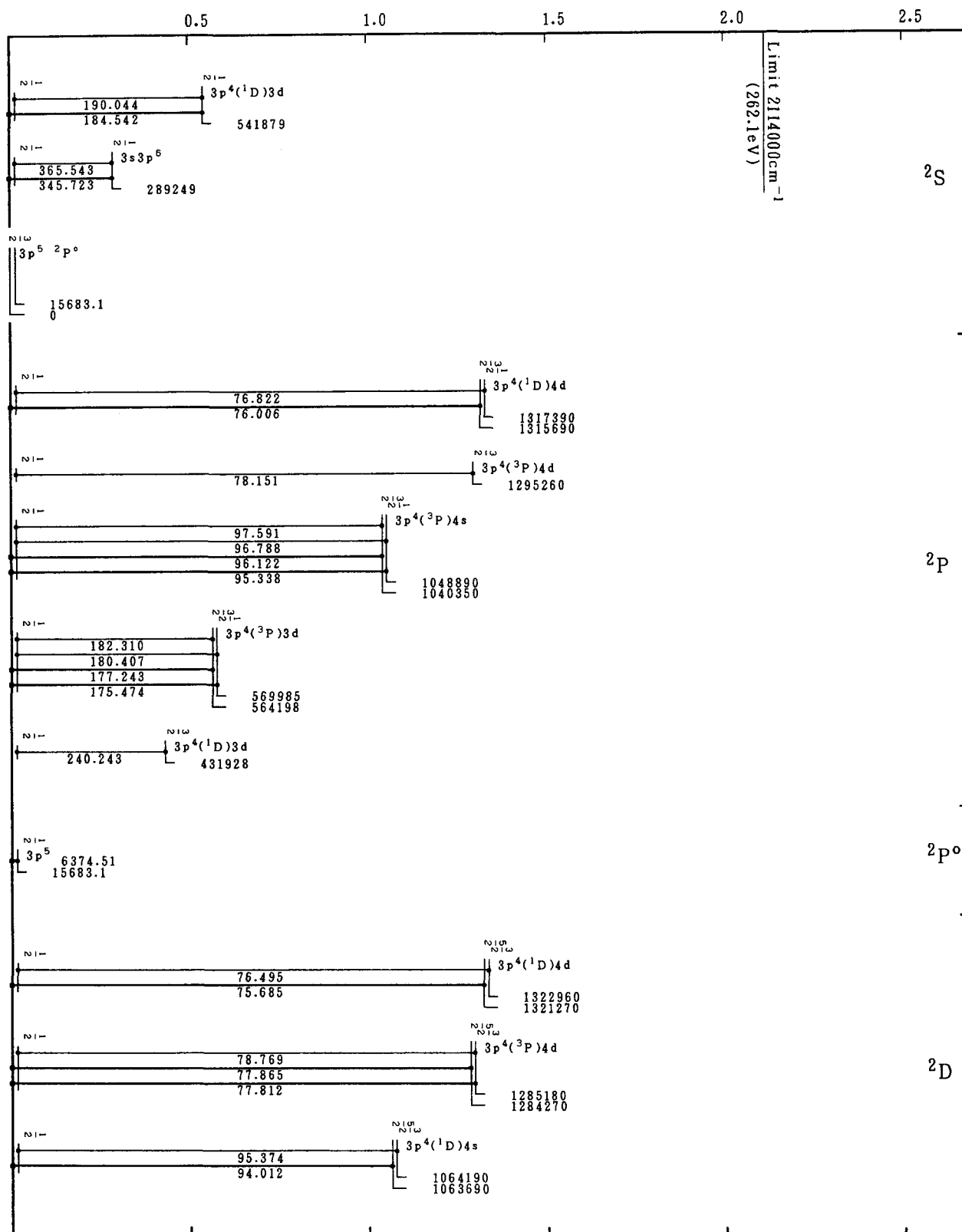
Energy (in 10^6cm^{-1})

Grotrian Diagrams for Fe X (Cl-Sequence)

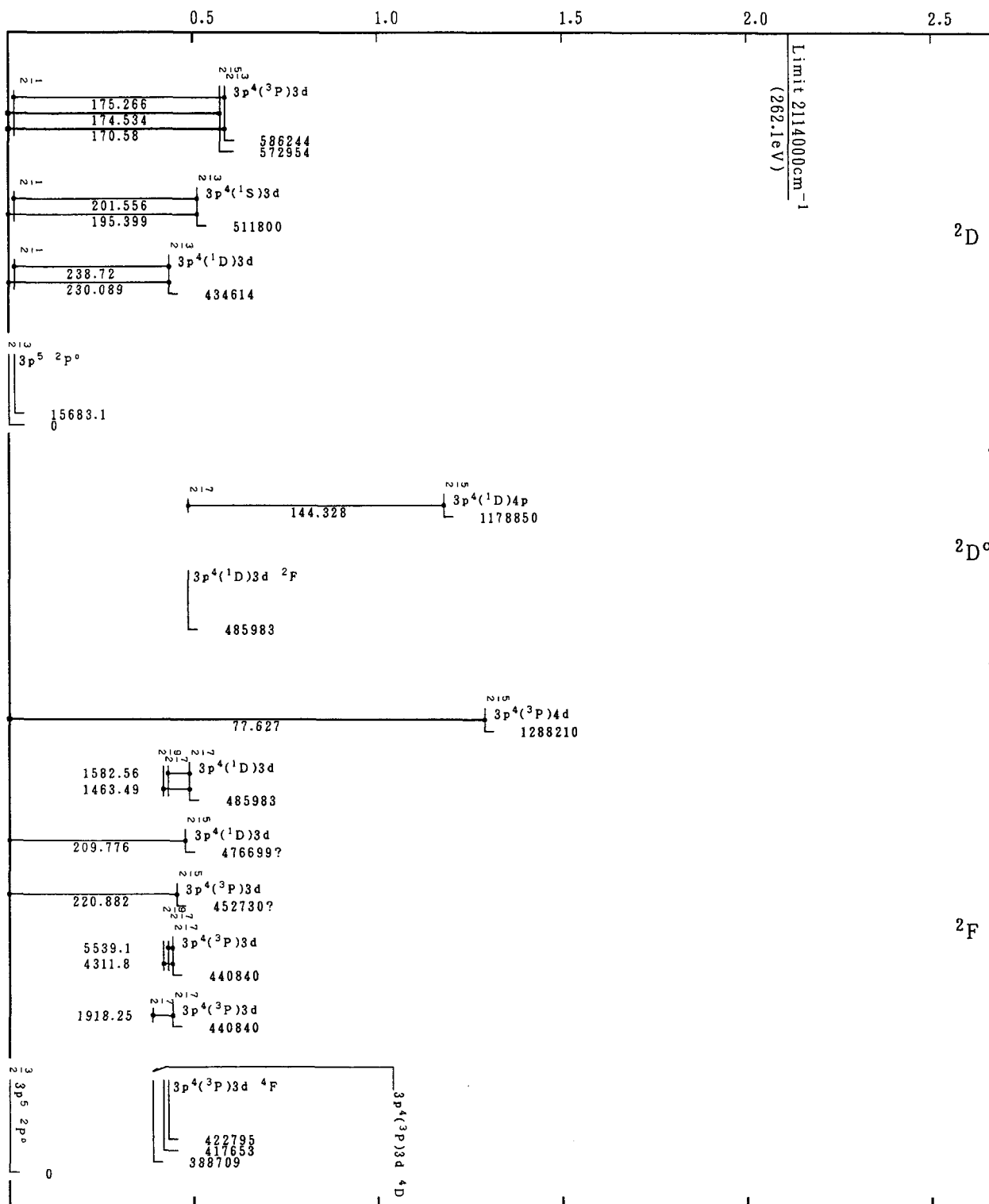
Energy (in 10^6cm^{-1})

Grotrian Diagrams for Fe X (Cl-Sequence)-Continued

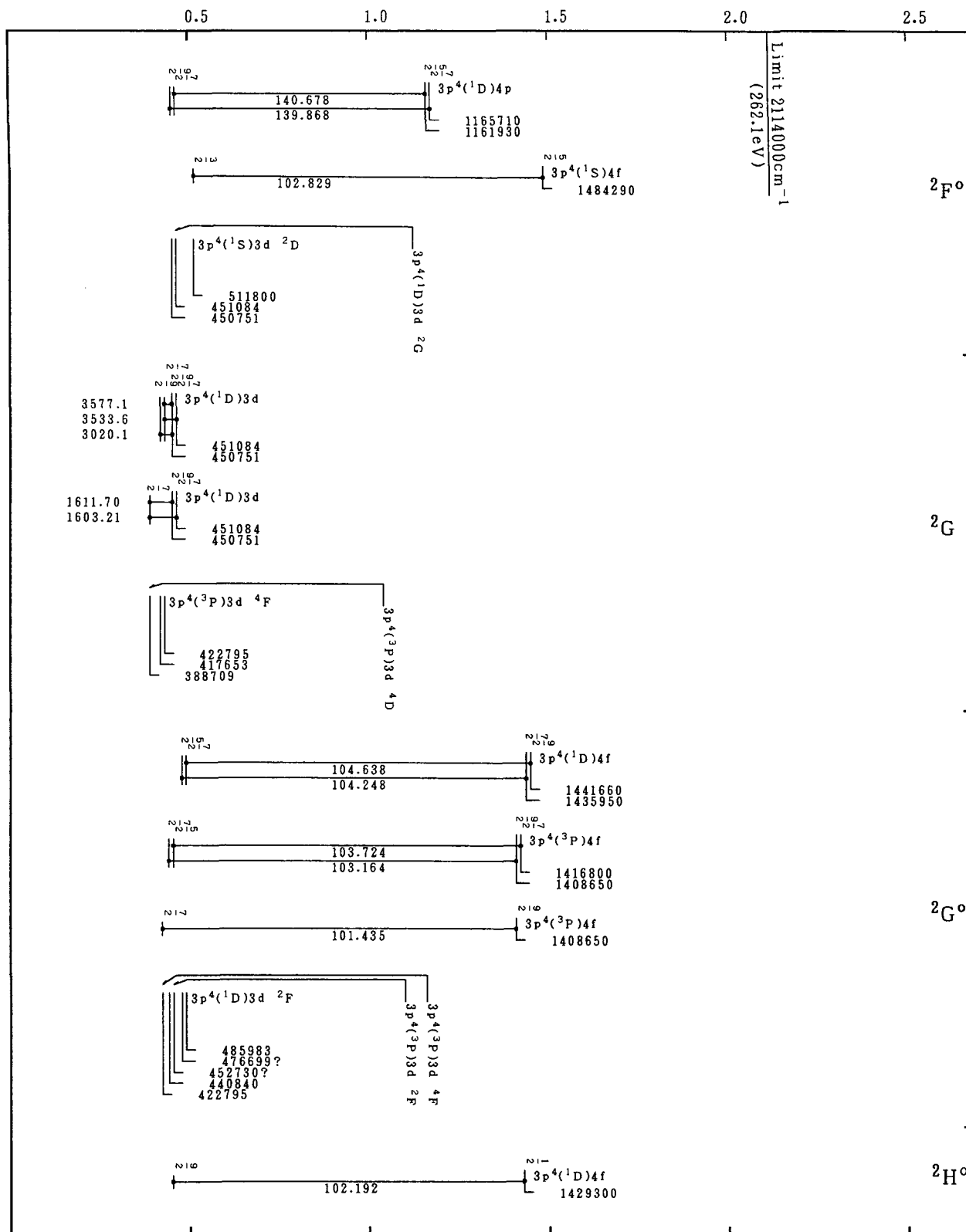
Energy (in 10^6cm^{-1})

Grotrian Diagrams for Fe X (Cl-Sequence)-Continued

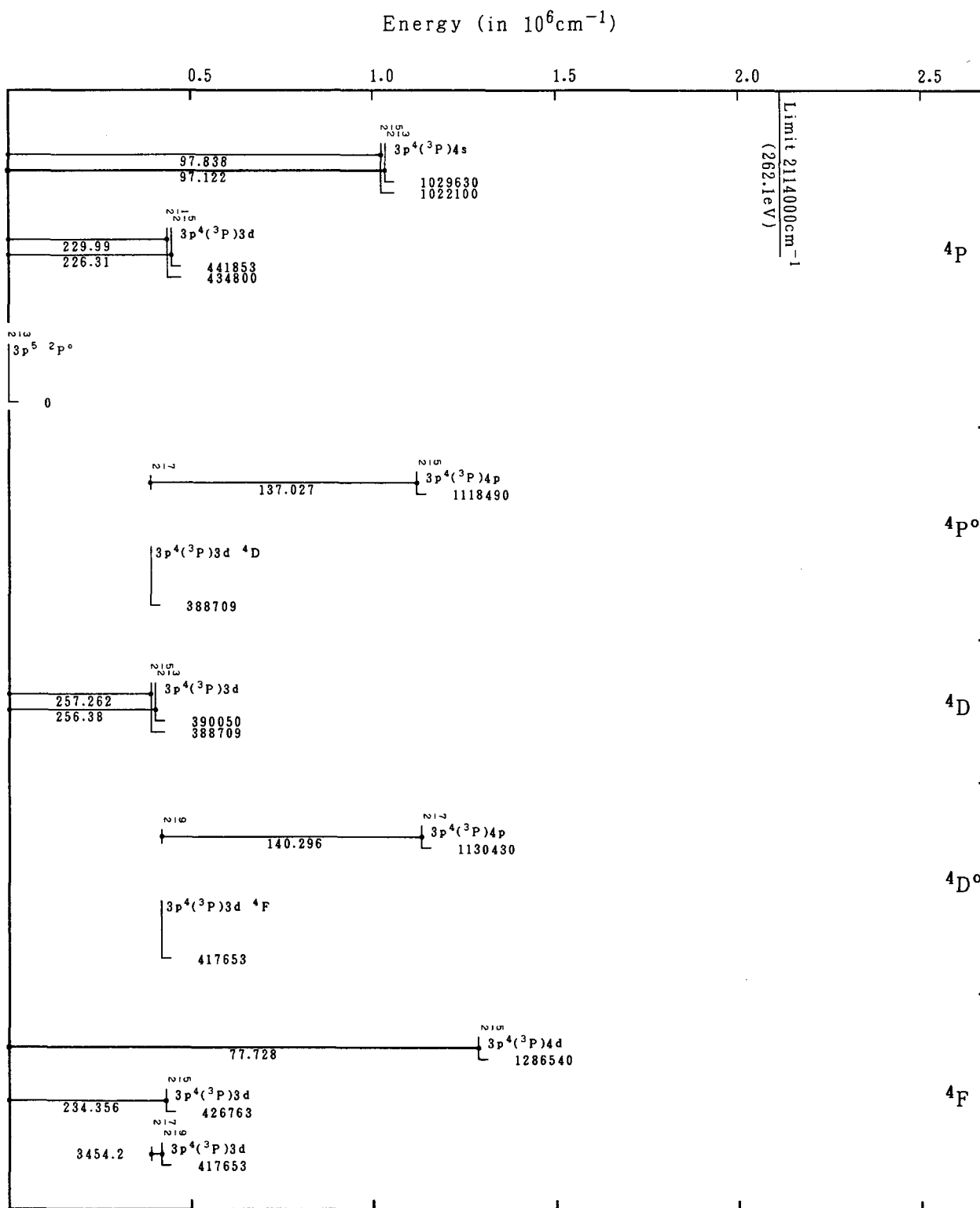

Energy (in 10^6cm^{-1})

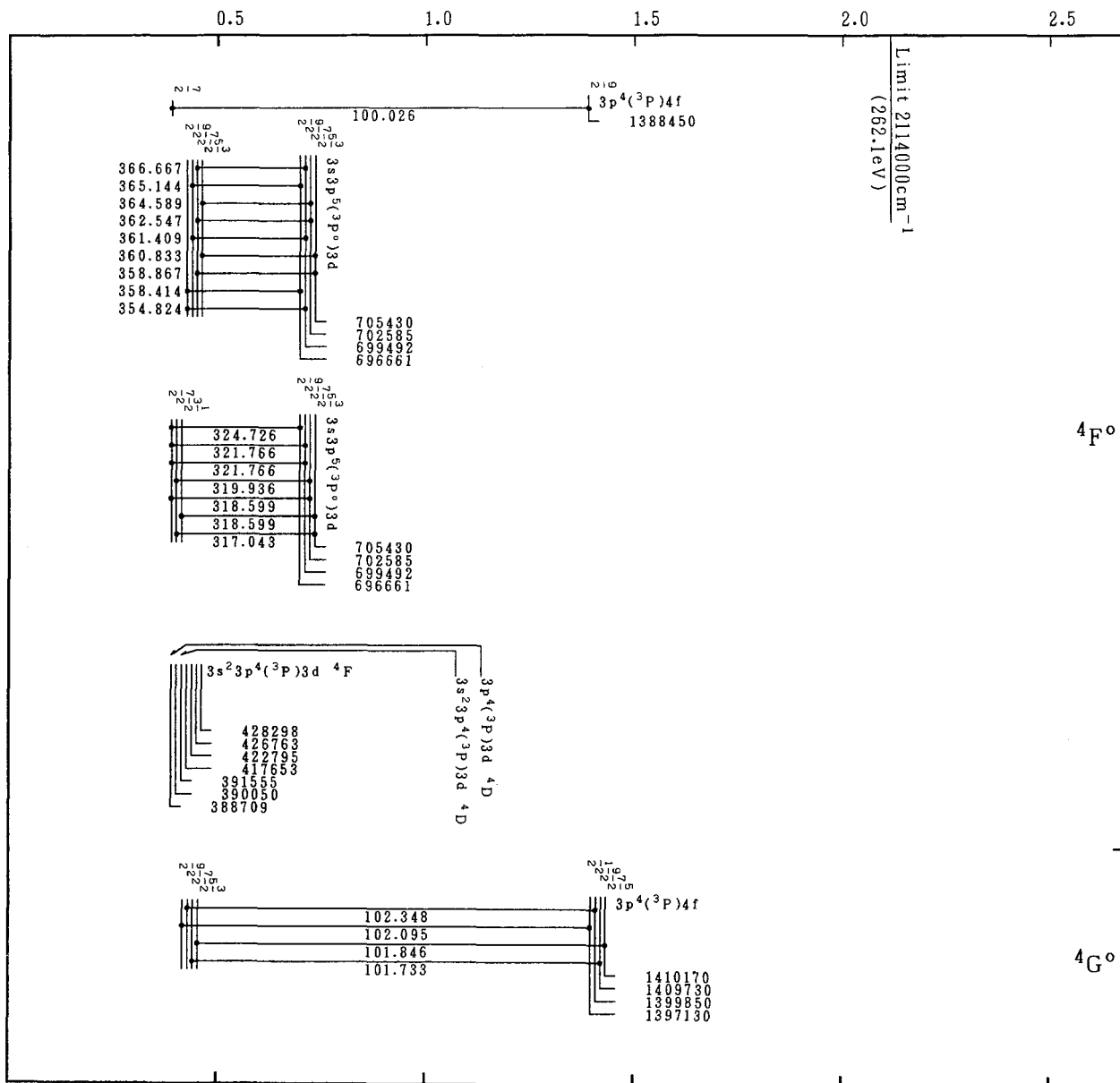

Grotrian Diagrams for Fe X (Cl-Sequence)-Continued

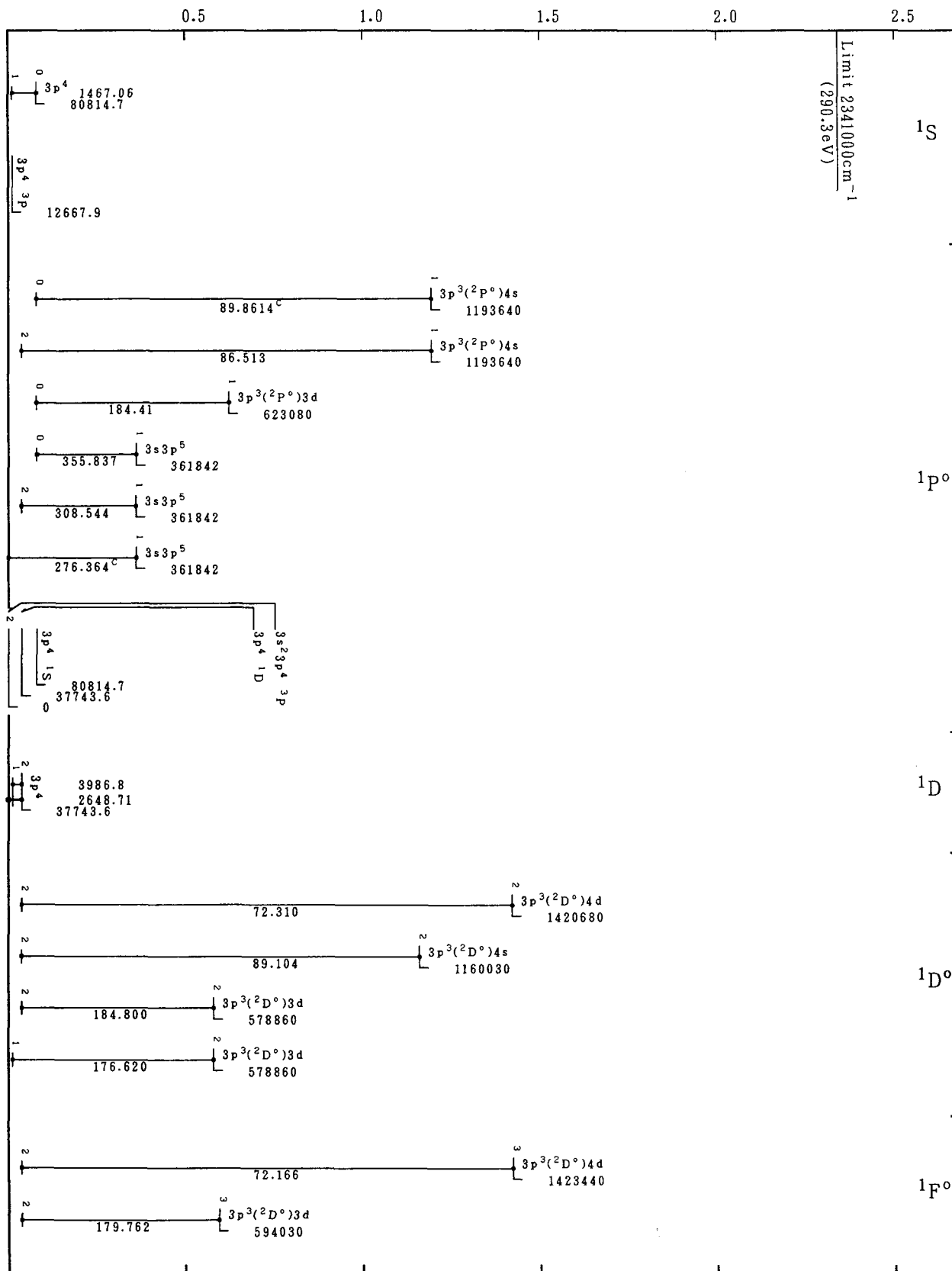
Energy (in 10^6cm^{-1})

Grotrian Diagrams for Fe XI (S-Sequence)

Energy (in 10^6cm^{-1})

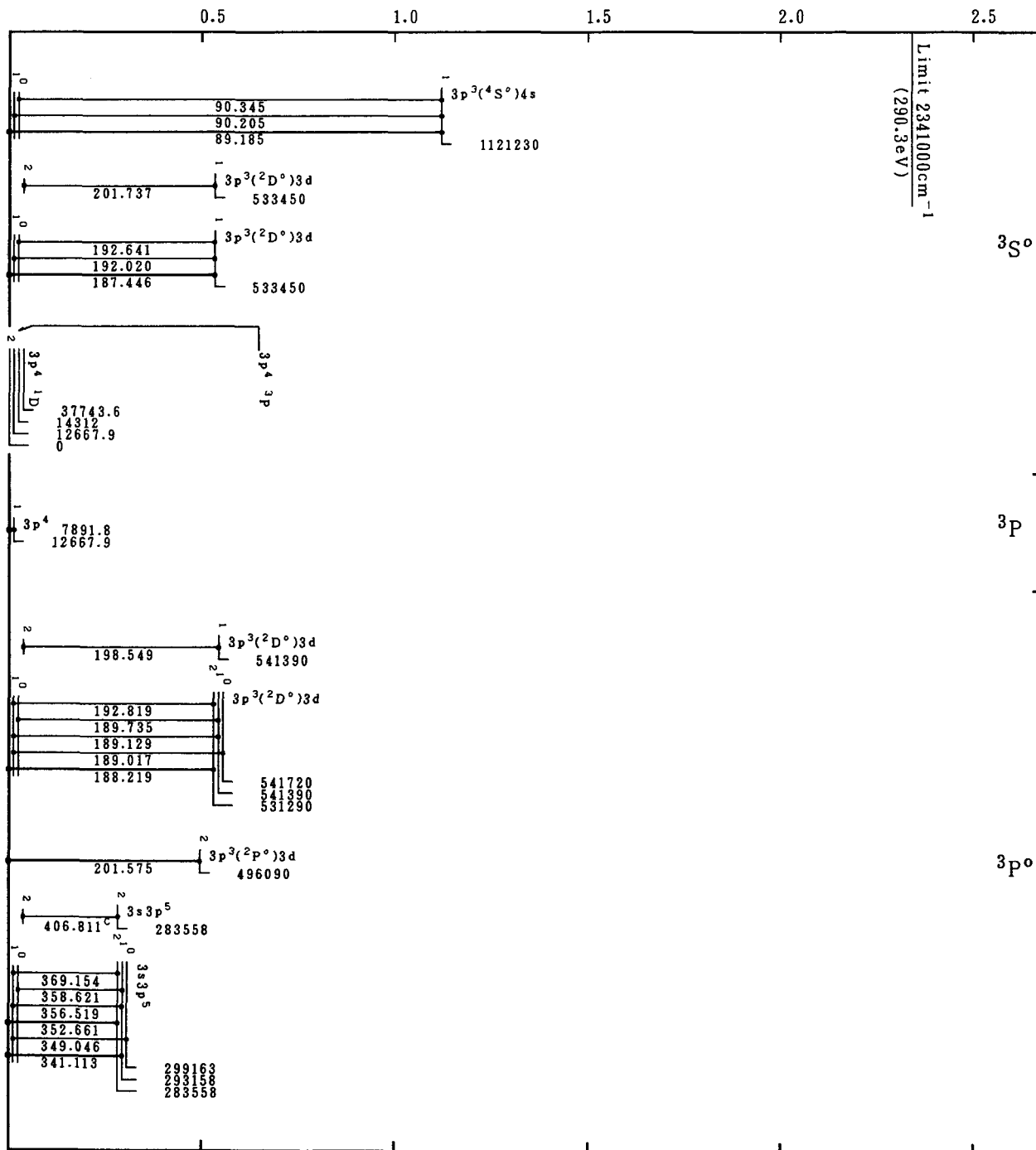

Grotrian Diagrams for Fe XI (S-Sequence)-Continued

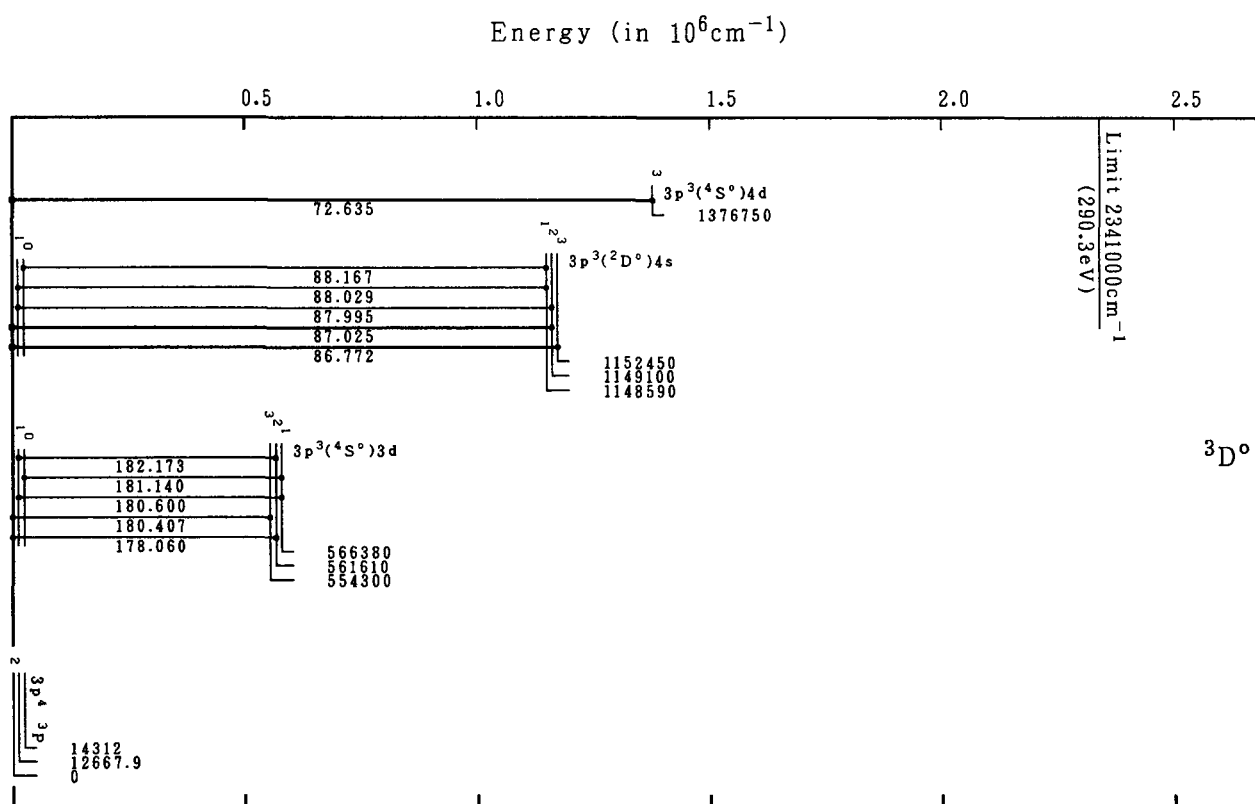

Grotrian Diagrams for Fe XI (S-Sequence)-Continued

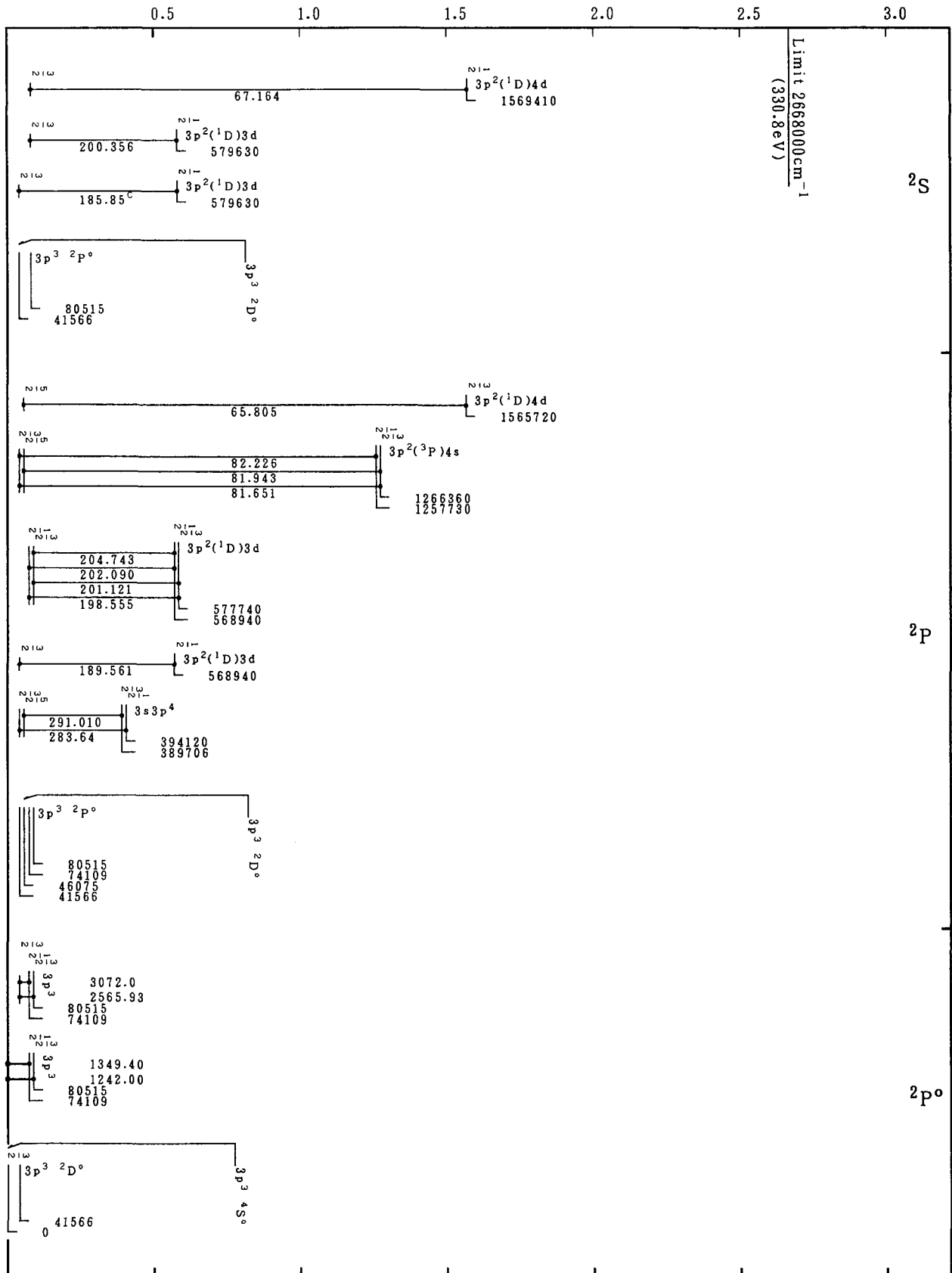
Energy (in 10^6cm^{-1})

Grotrian Diagrams for Fe XII (P-Sequence)

Energy (in 10^6cm^{-1})

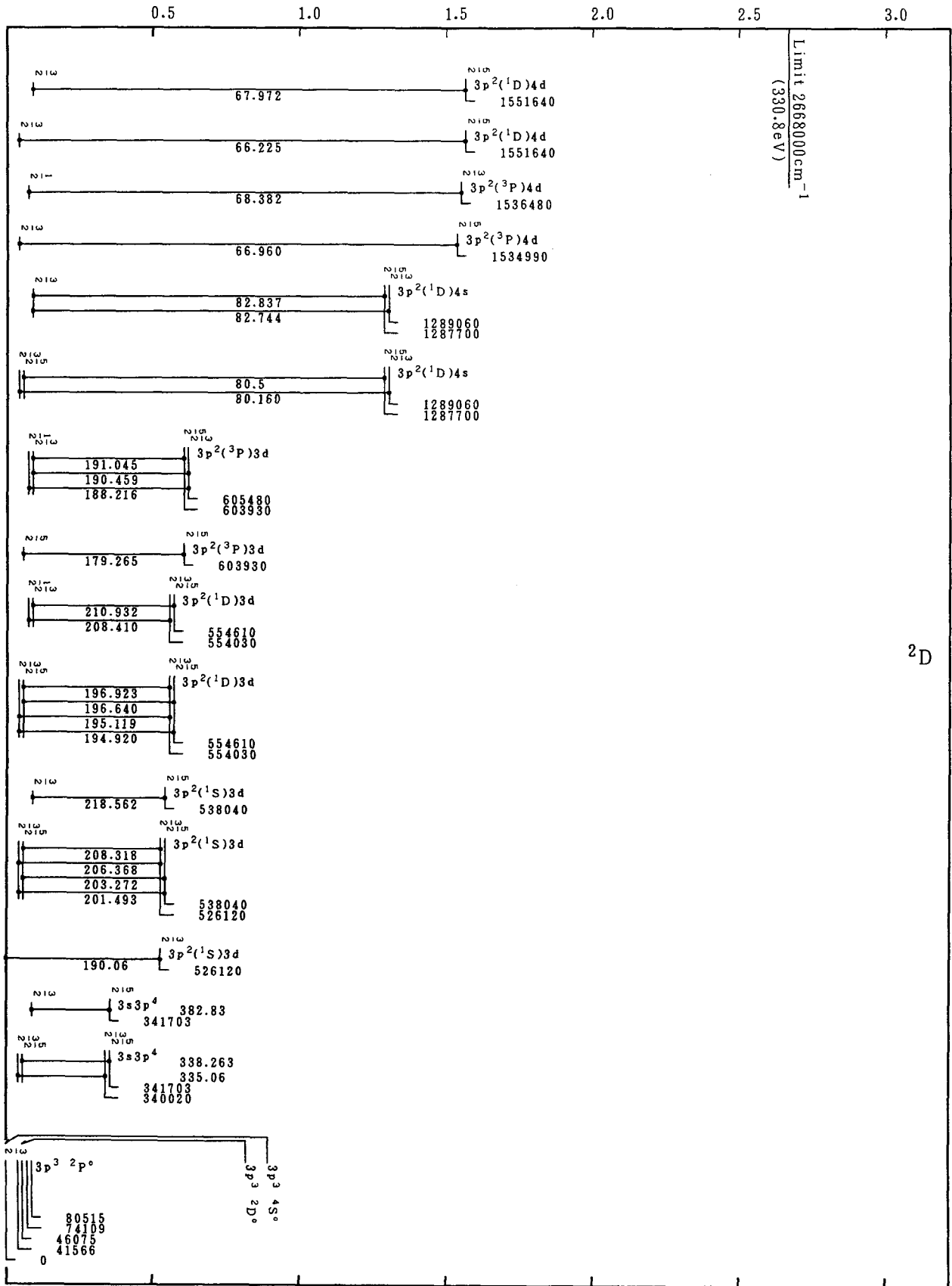

Grotrian Diagrams for Fe XII (P-Sequence)-Continued

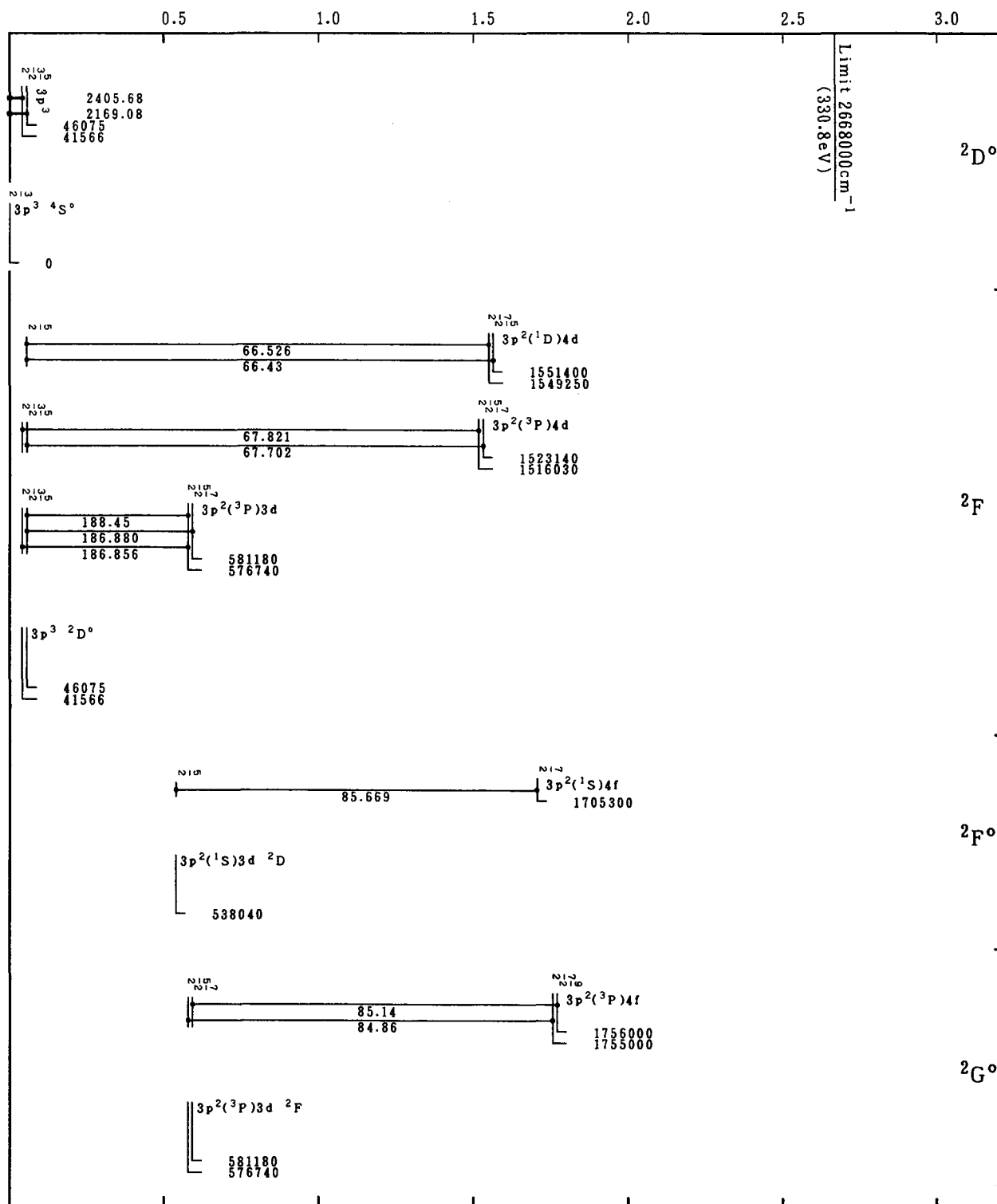
Energy (in 10^6cm^{-1})

Grotrian Diagrams for Fe XII (P-Sequence)-Continued

Energy (in 10^6cm^{-1})

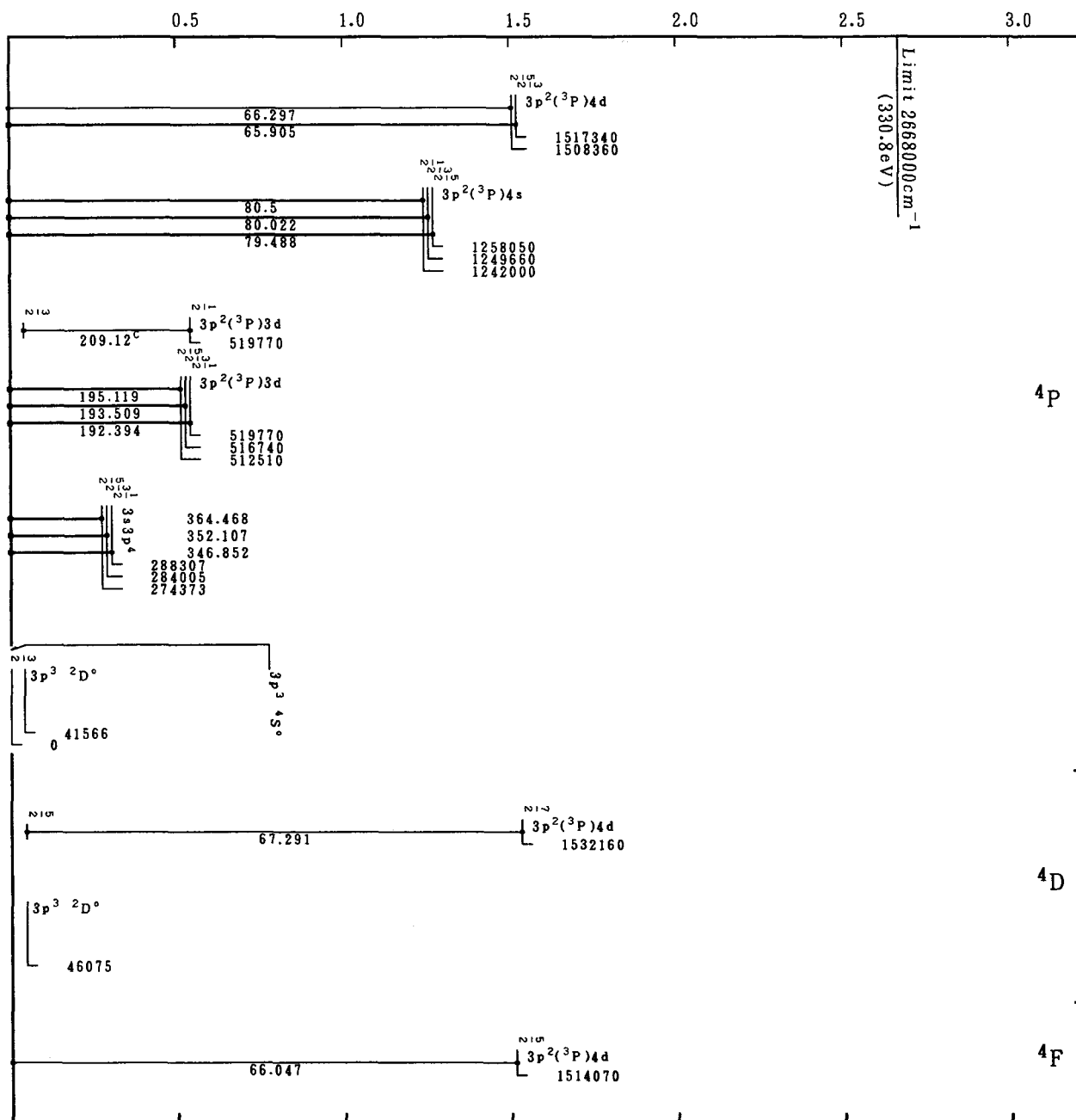

Grotrian Diagrams for Fe XII (P-Sequence)-Continued

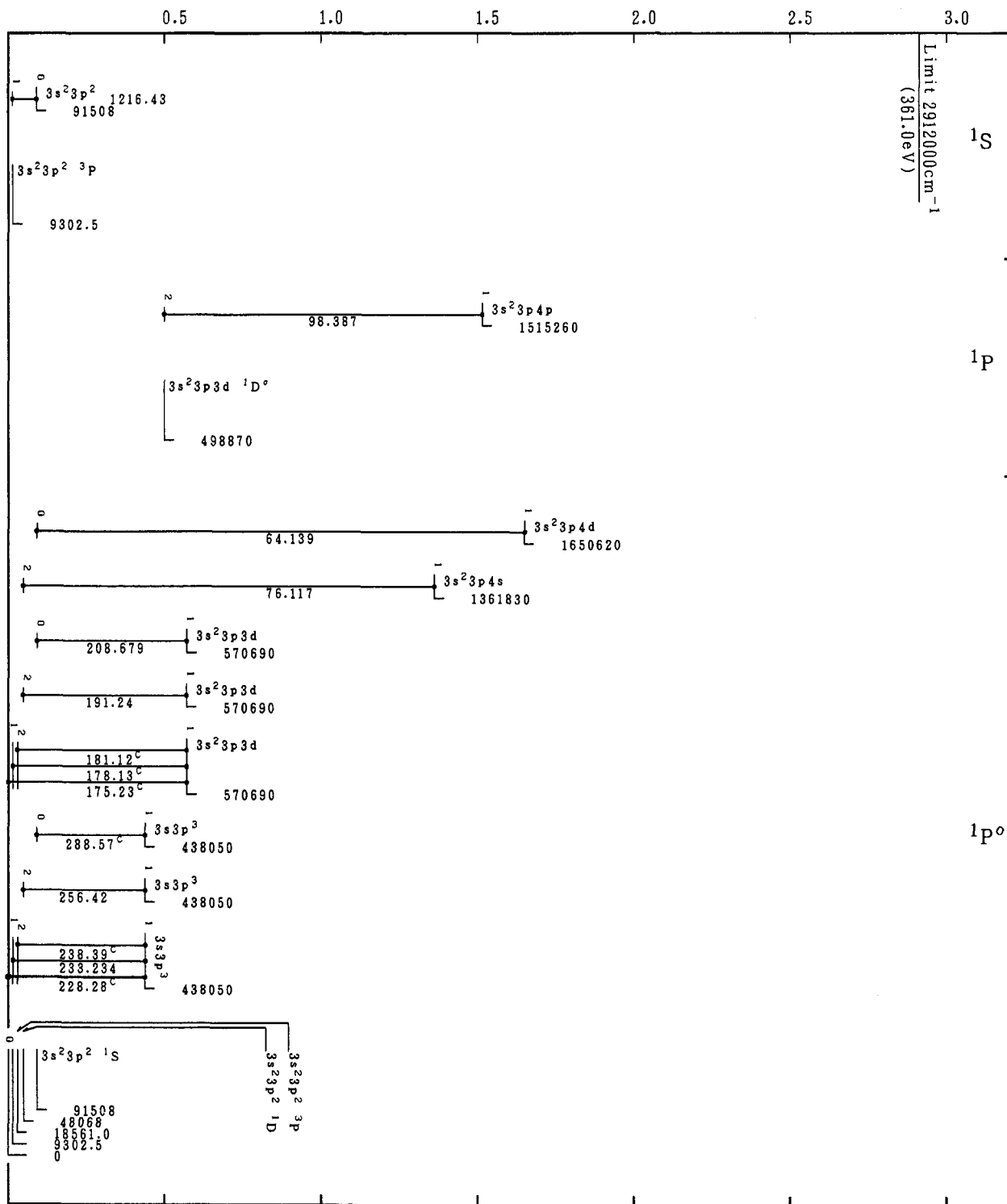
Energy (in 10^6cm^{-1})

Grotrian Diagrams for Fe XIII (Si-Sequence)

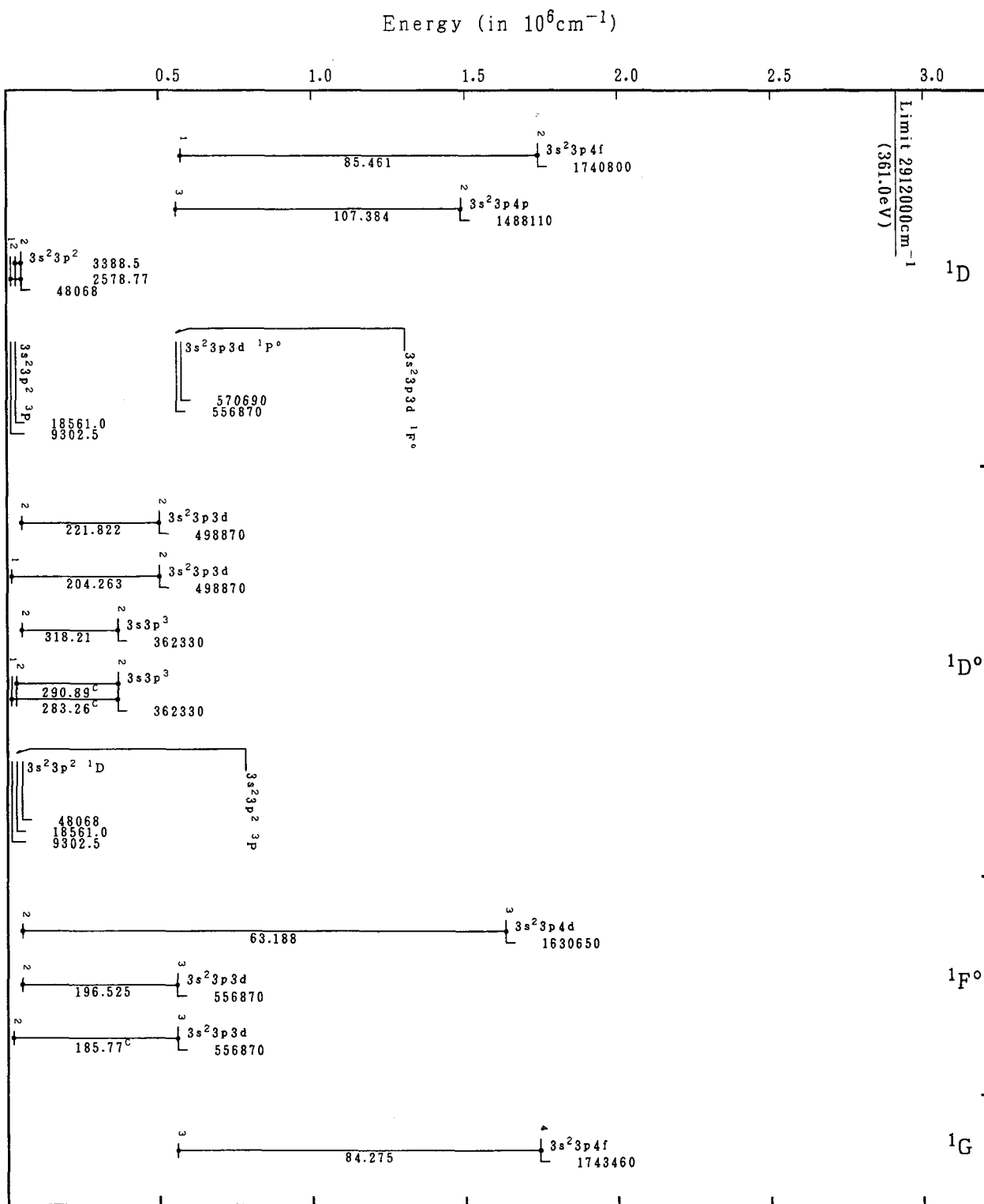

Grotrian Diagrams for Fe XIII (Si-Sequence)-Continued

Energy (in 10^6cm^{-1})

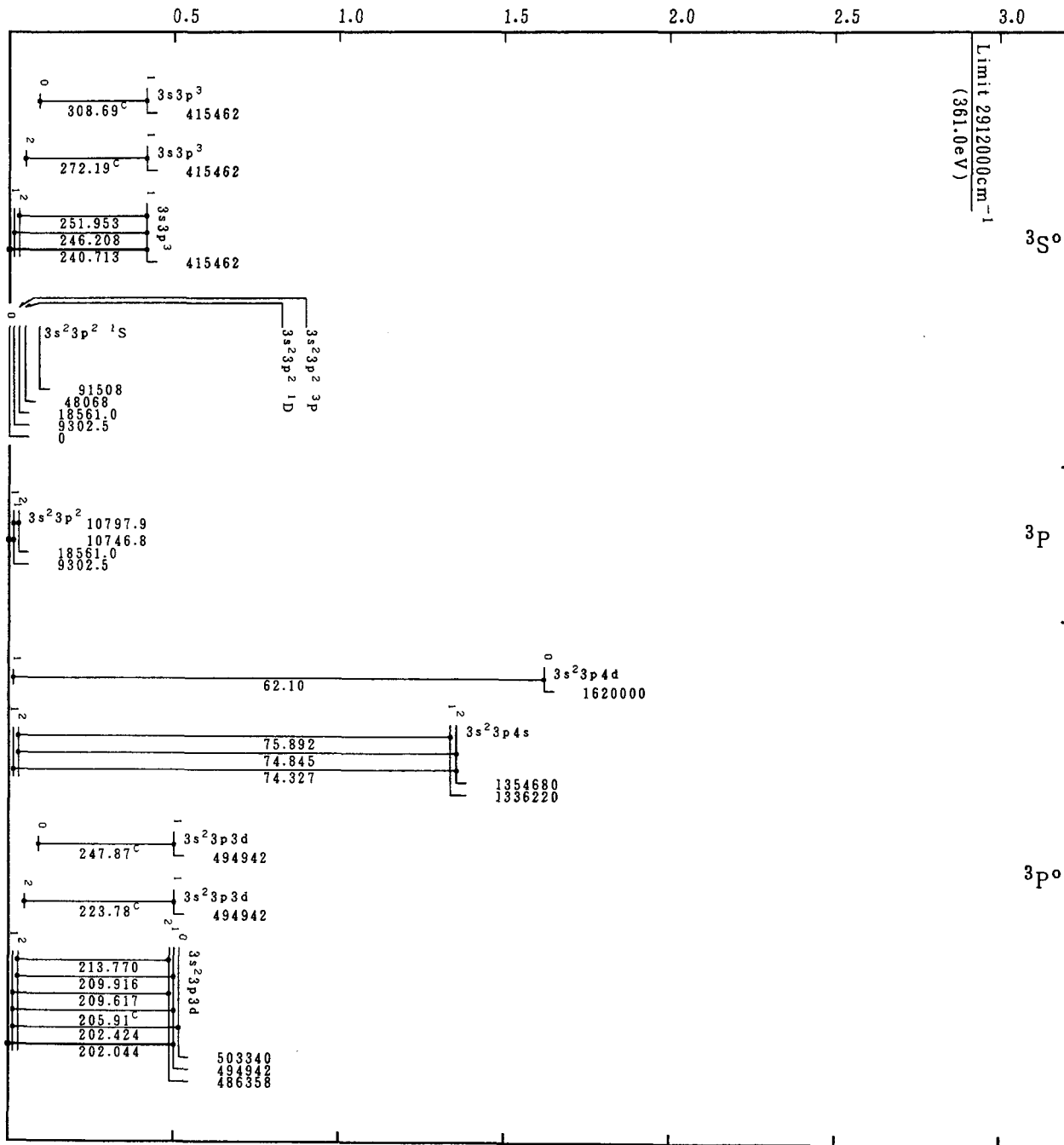

Grotrian Diagrams for Fe XIII (Si-Sequence)-Continued

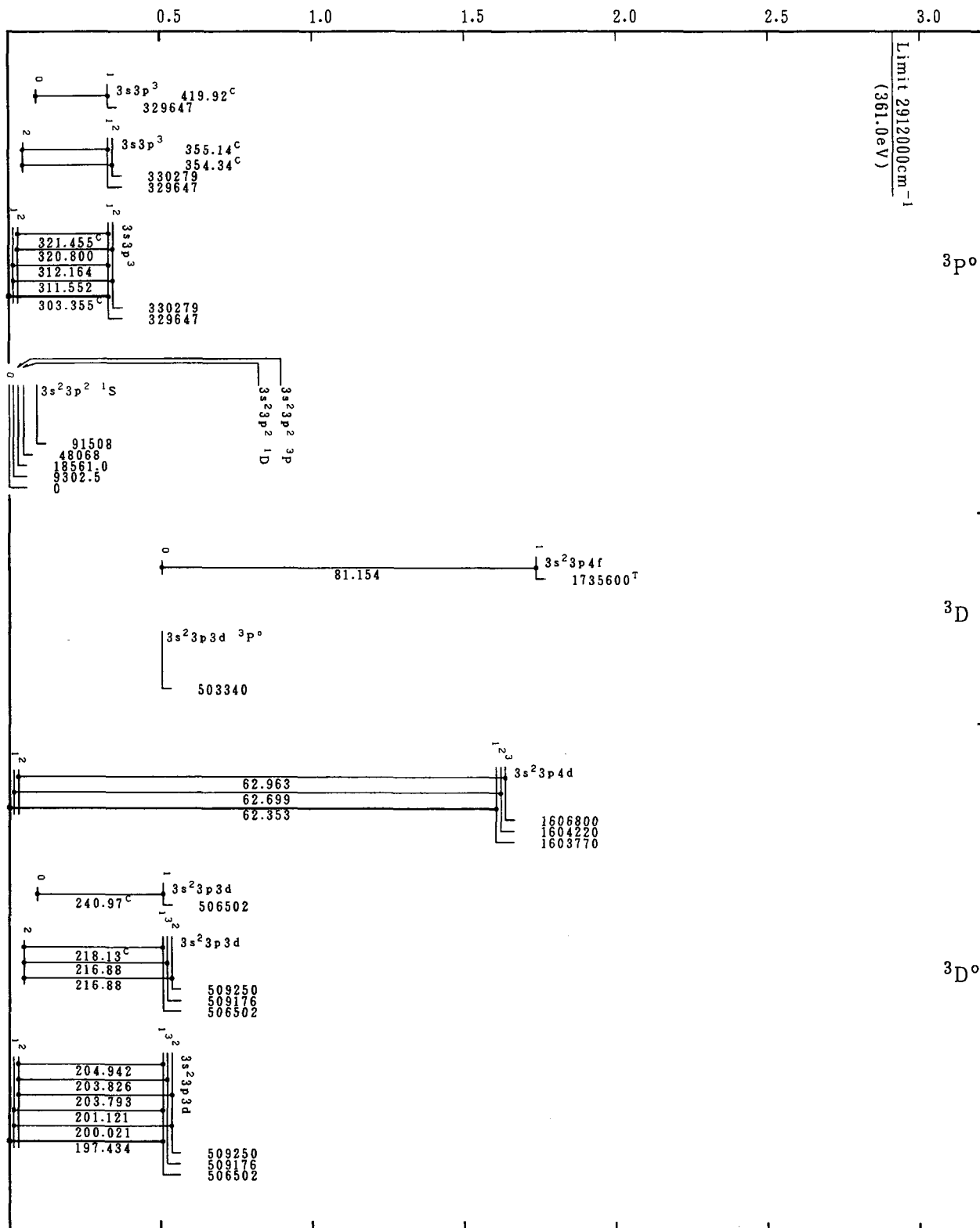
Energy (in 10^6cm^{-1})

Grotrian Diagrams for Fe XIII (Si-Sequence)-Continued

Energy (in 10^6cm^{-1})

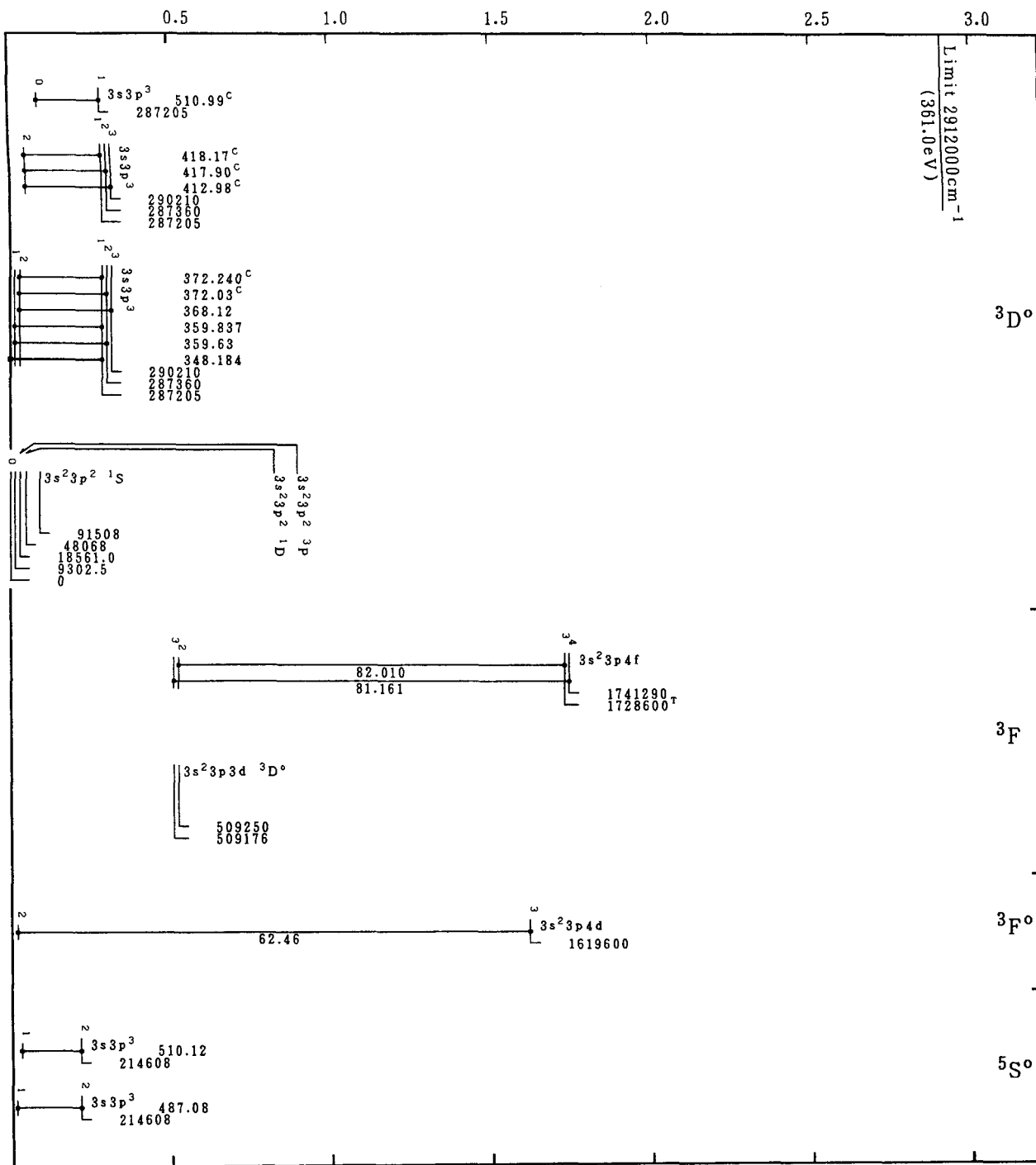

Grotrian Diagrams for Fe XIII (Si-Sequence)-Continued

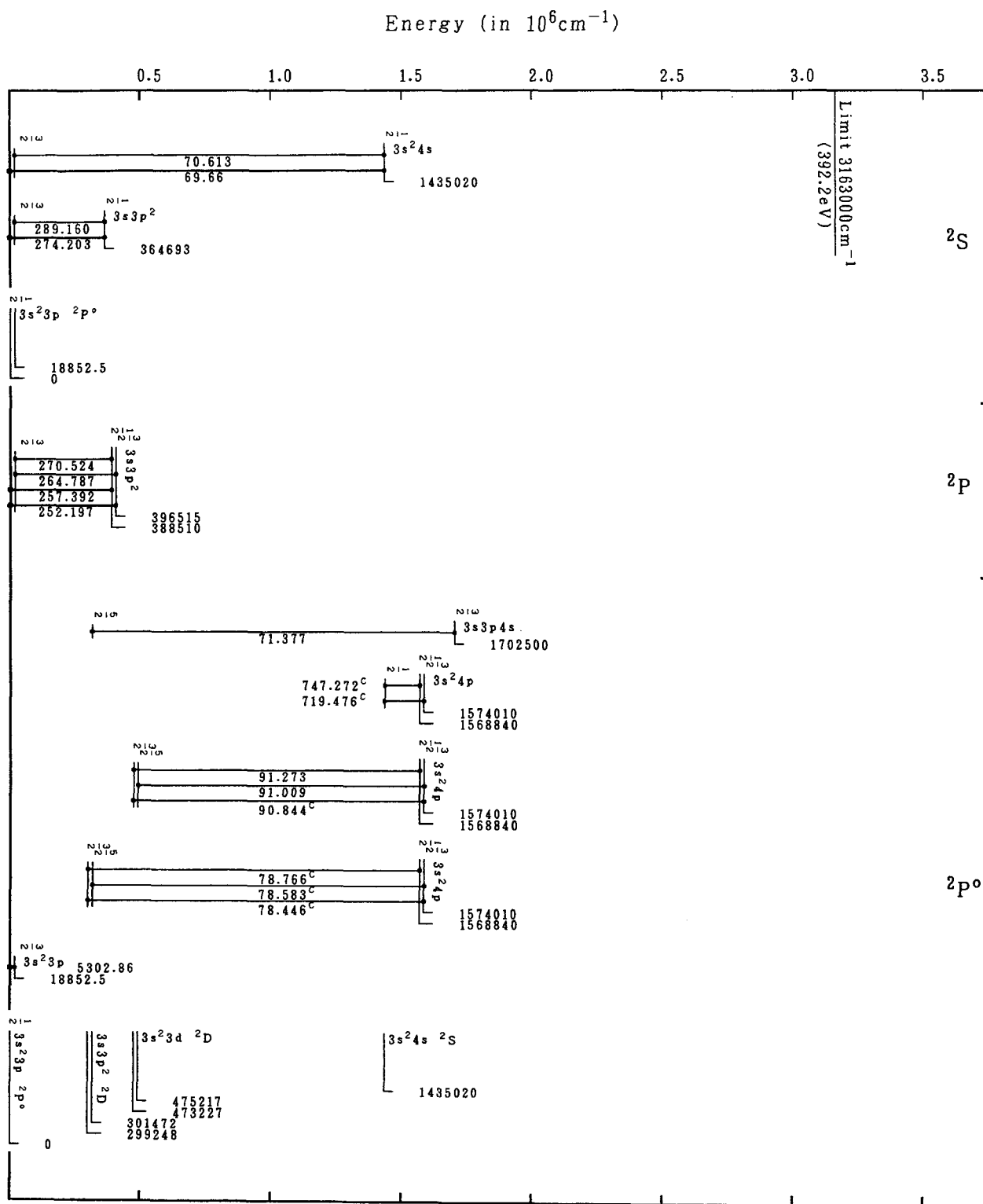

Grotrian Diagrams for Fe XIV (Al-Sequence)

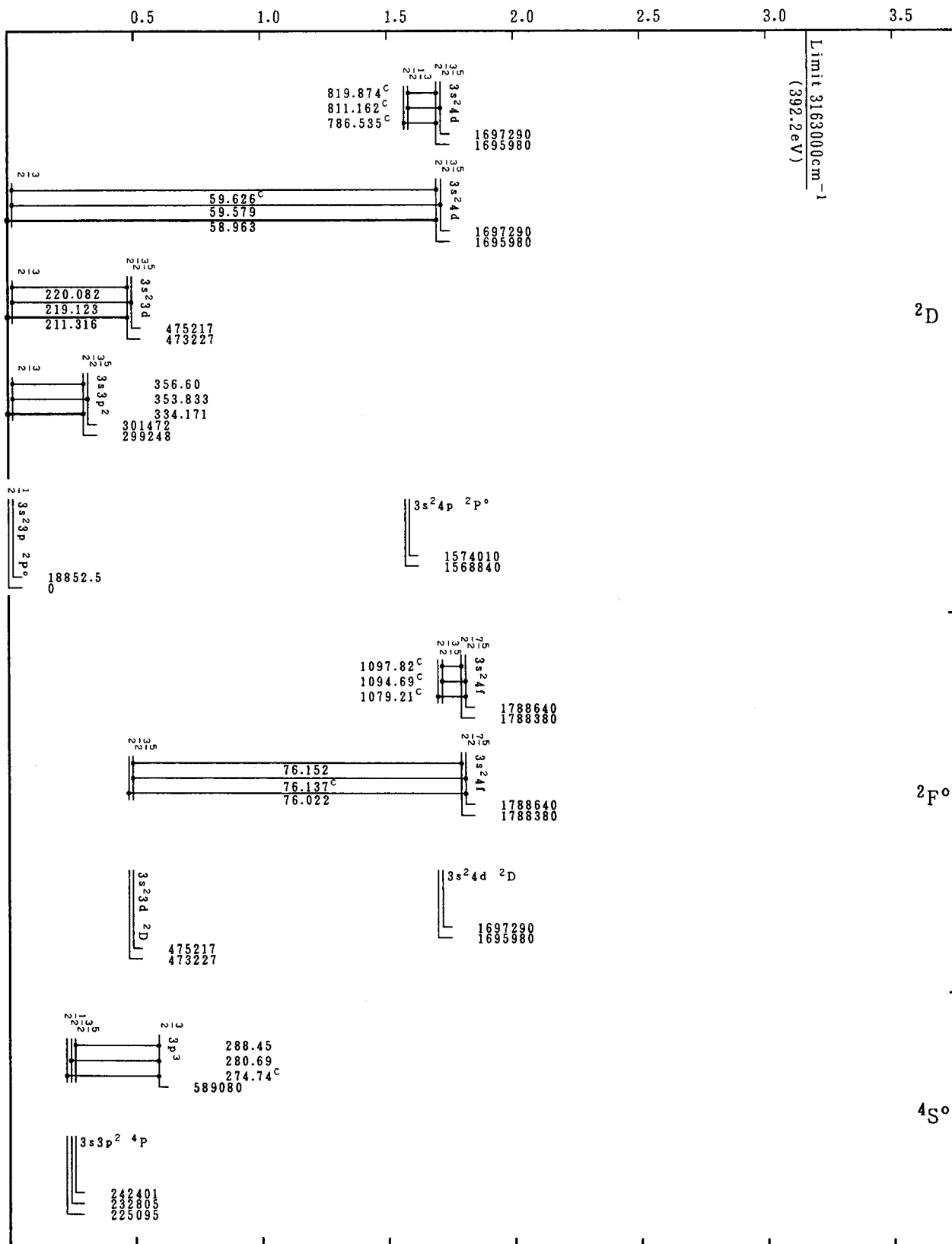
Energy (in 10^6cm^{-1})

Grotrian Diagrams for Fe XIV (Al-Sequence)-Continued

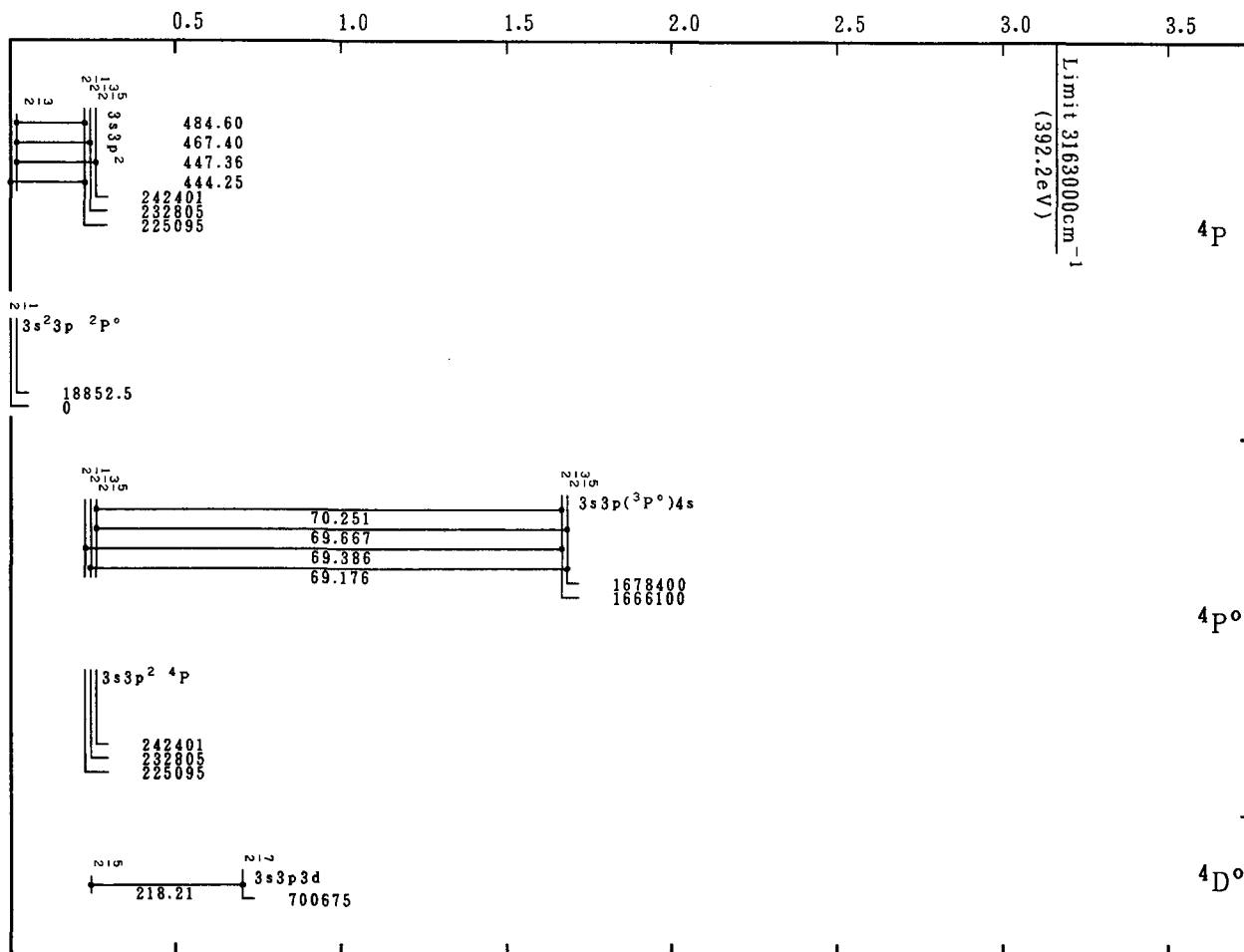
Energy (in 10^6cm^{-1})

Grotrian Diagrams for Fe XIV (Al-Sequence)-Continued

Energy (in 10^6cm^{-1})

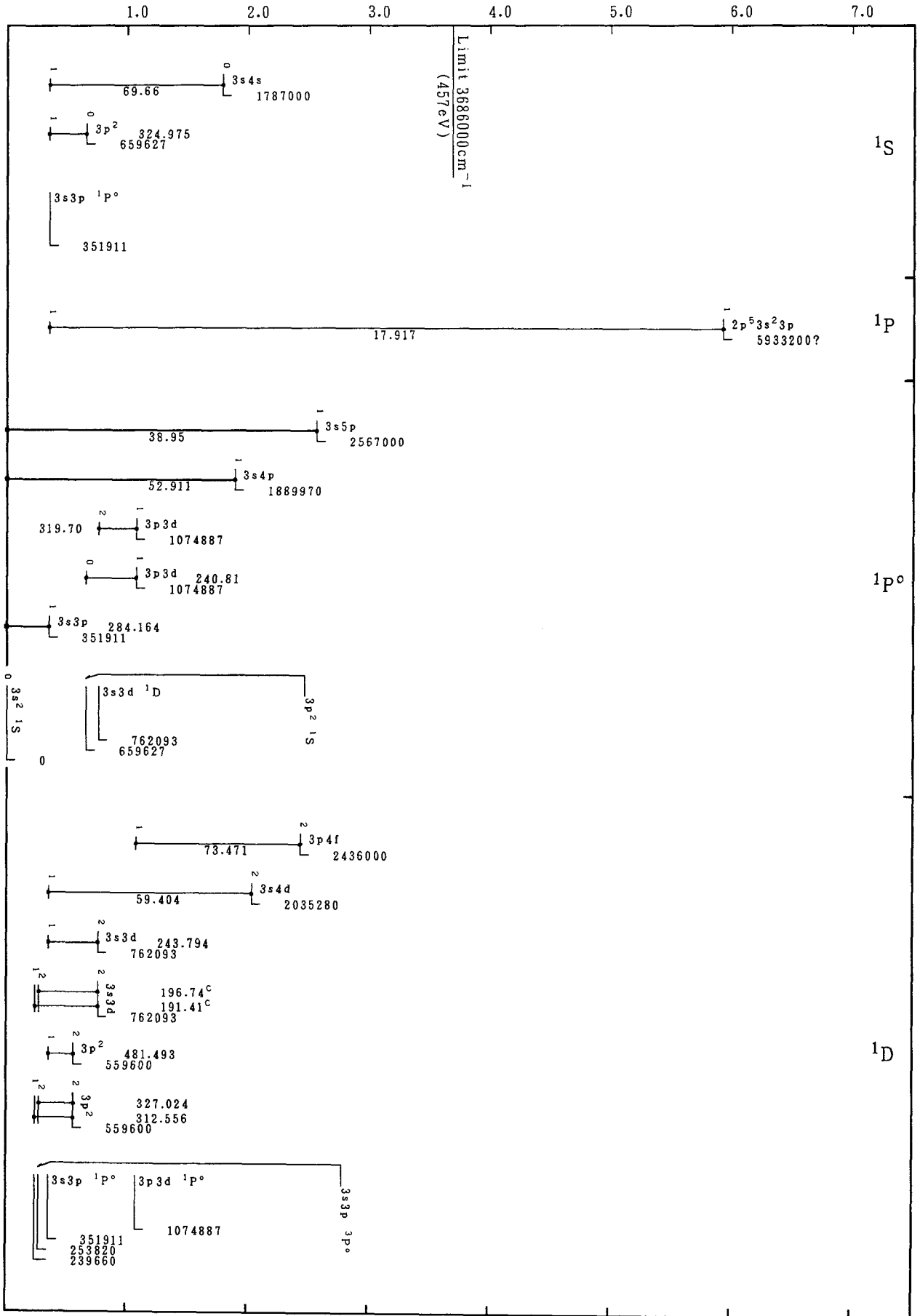

Grotrian Diagrams for Fe XV (Mg-Sequence)

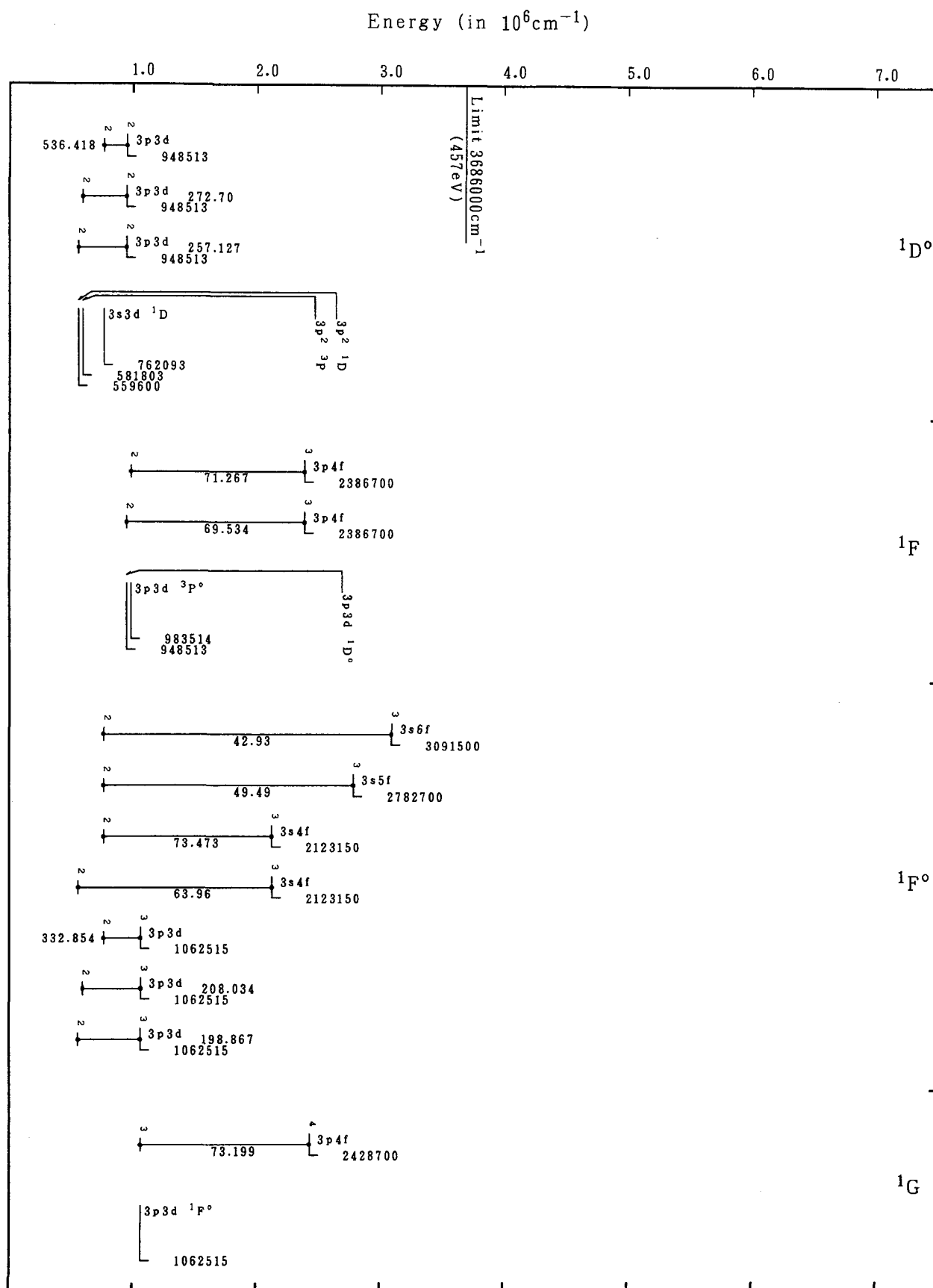

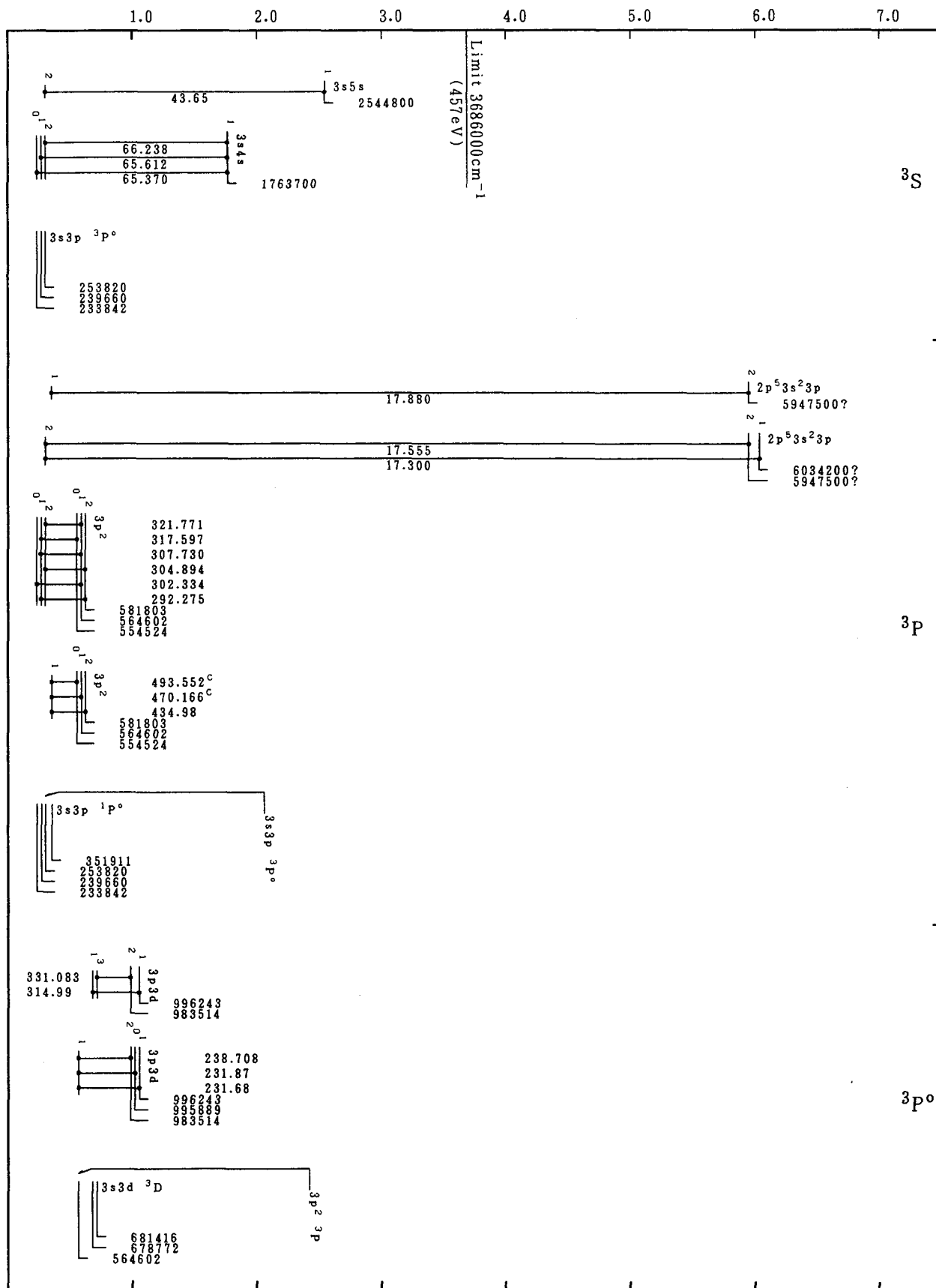
Energy (in 10^6cm^{-1})

Grotrian Diagrams for Fe XV (Mg-Sequence)-Continued

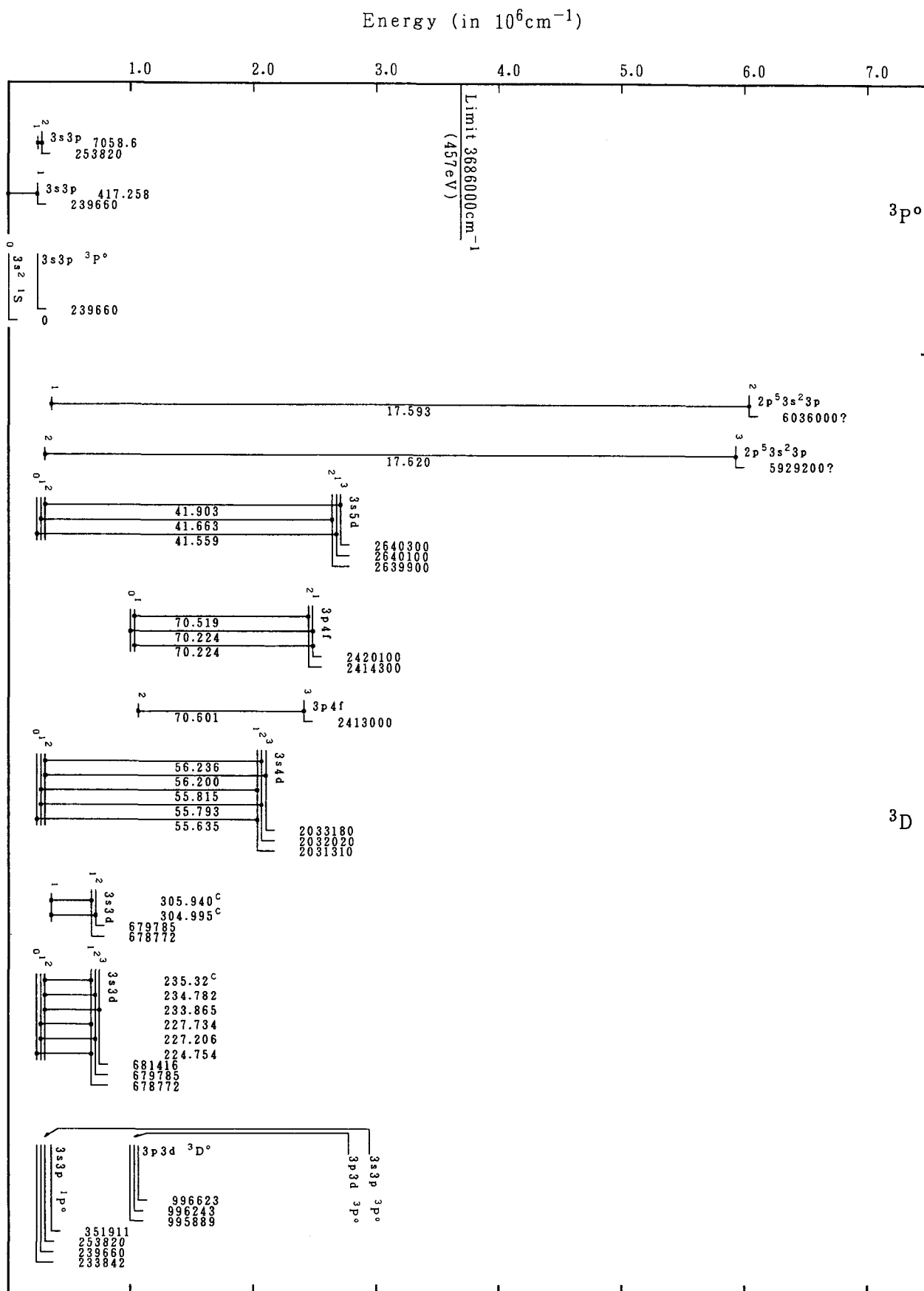

Grotrian Diagrams for Fe XV (Mg-Sequence)-Continued

Energy (in 10^6cm^{-1})

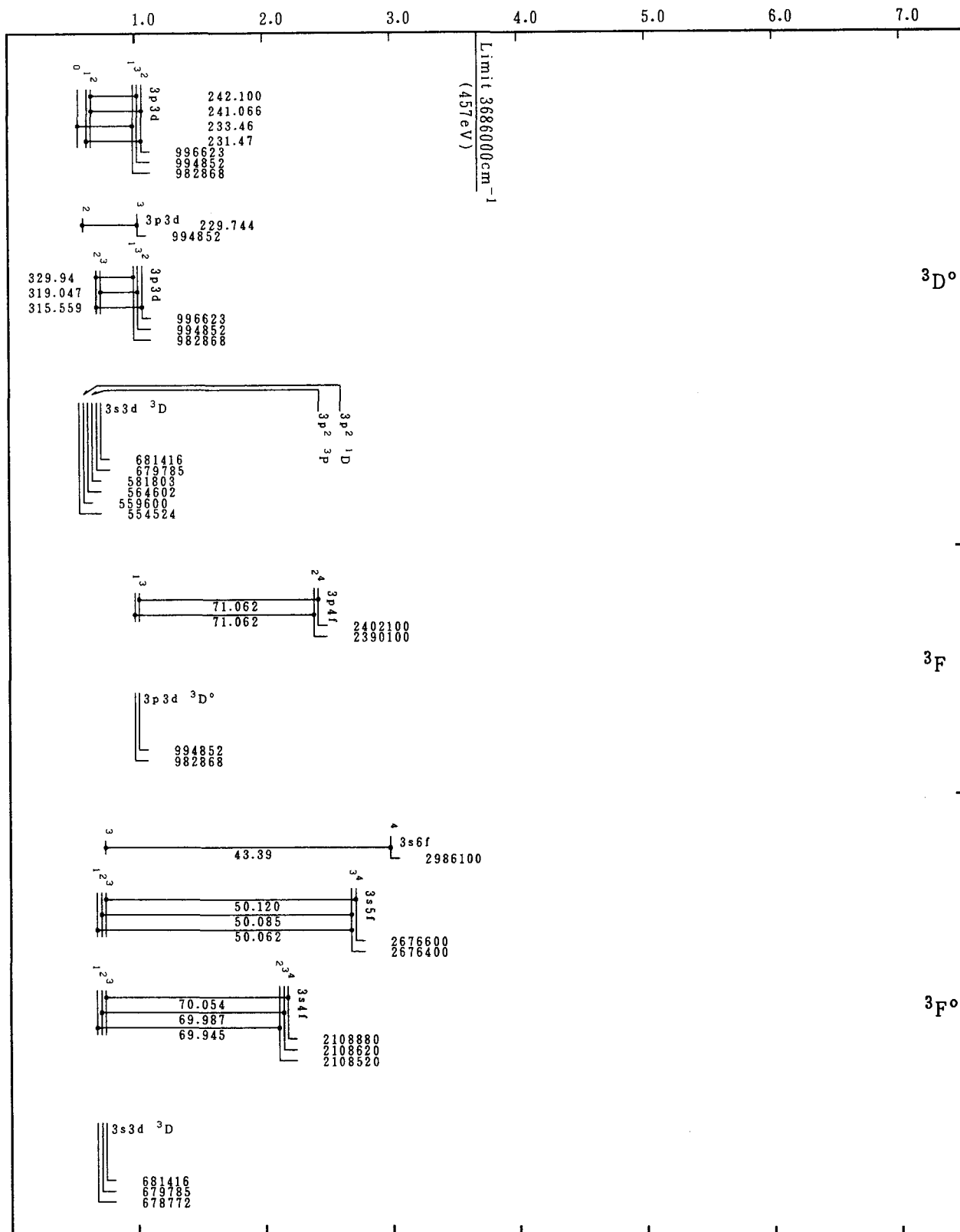

Grotrian Diagrams for Fe XV (Mg-Sequence)-Continued

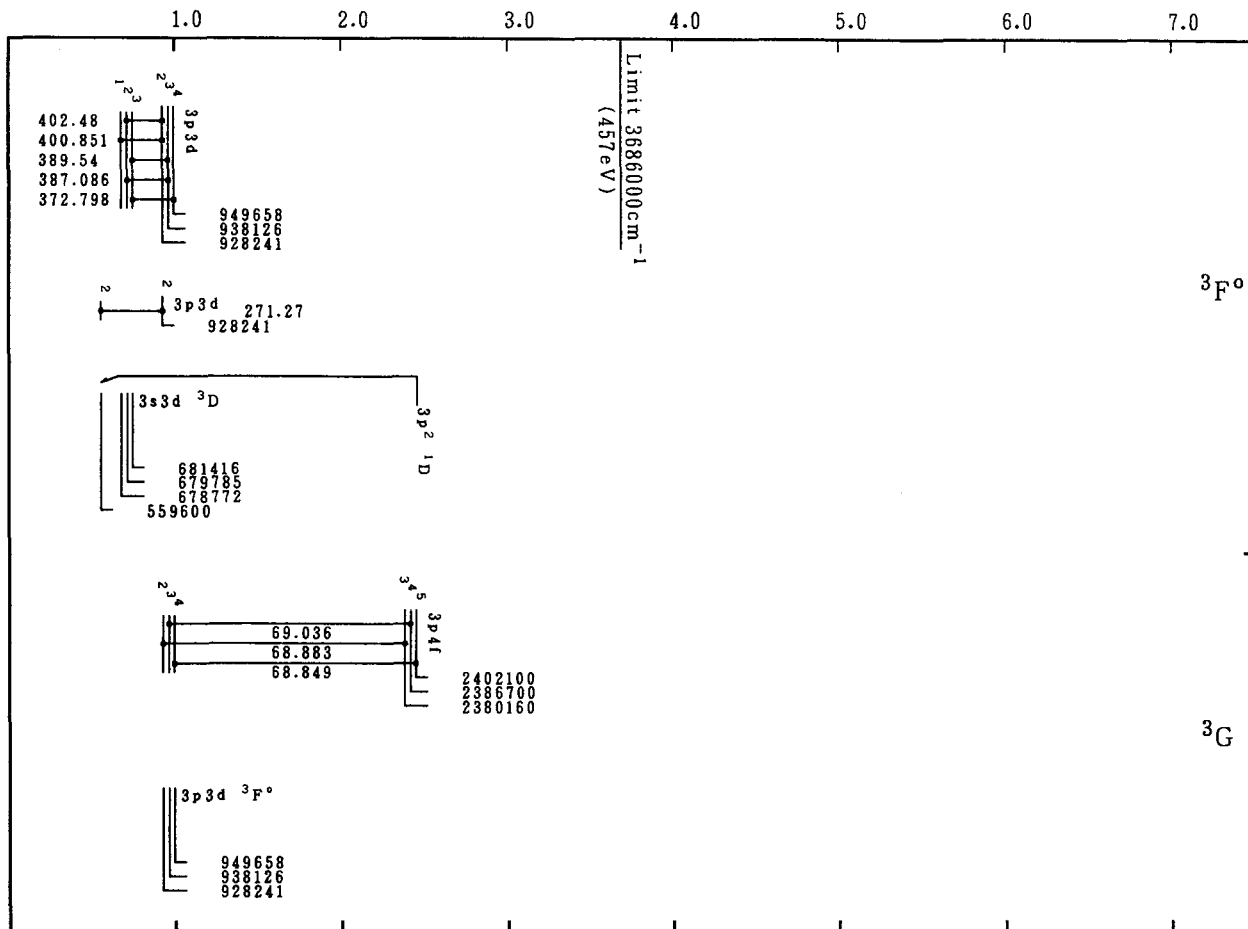
Energy (in 10^6cm^{-1})

Grotrian Diagrams for Fe XV (Mg-Sequence)-Continued

Energy (in 10^6cm^{-1})

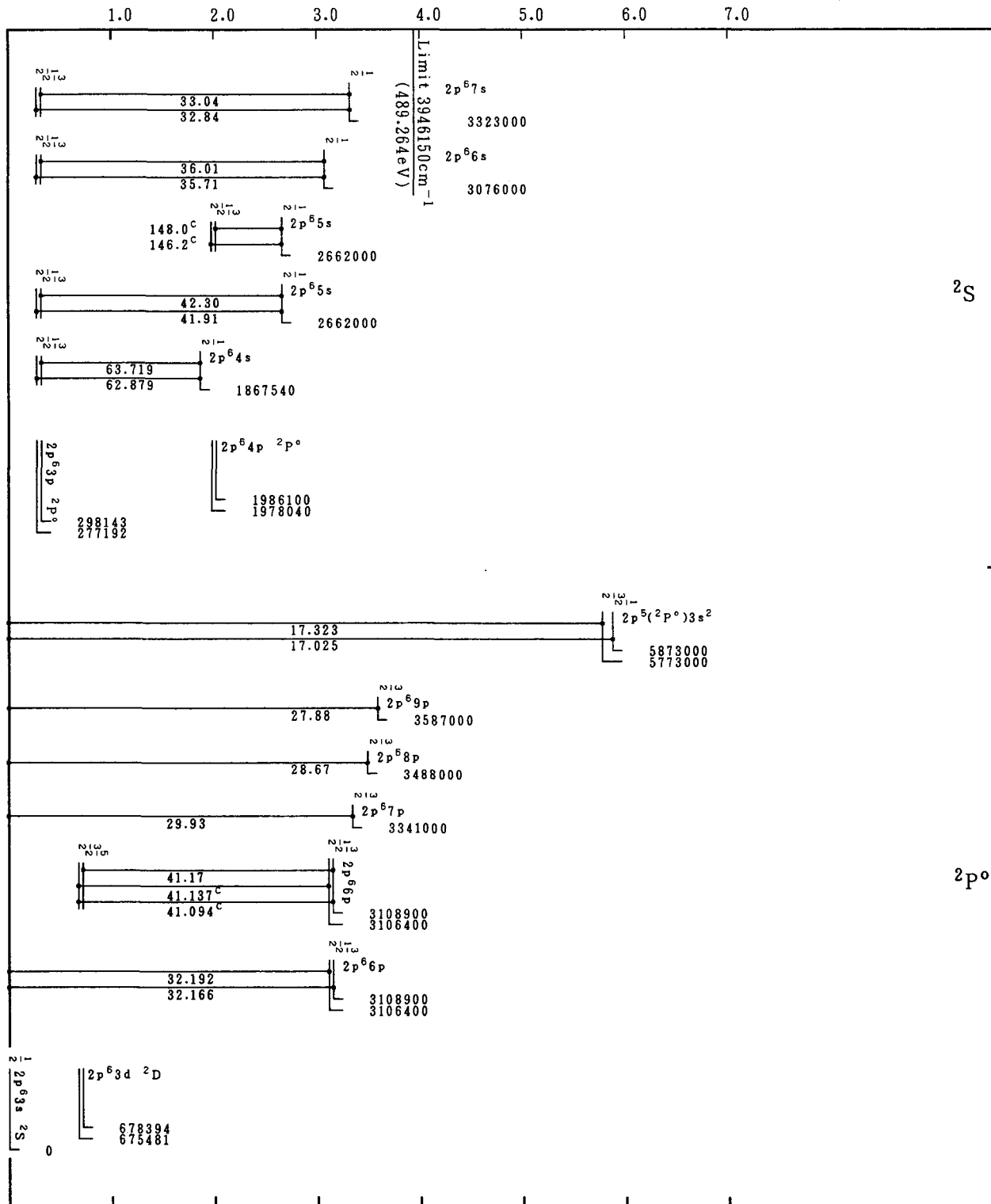

Grotrian Diagrams for Fe XVI (Na-Sequence)

Energy (in 10^6cm^{-1})

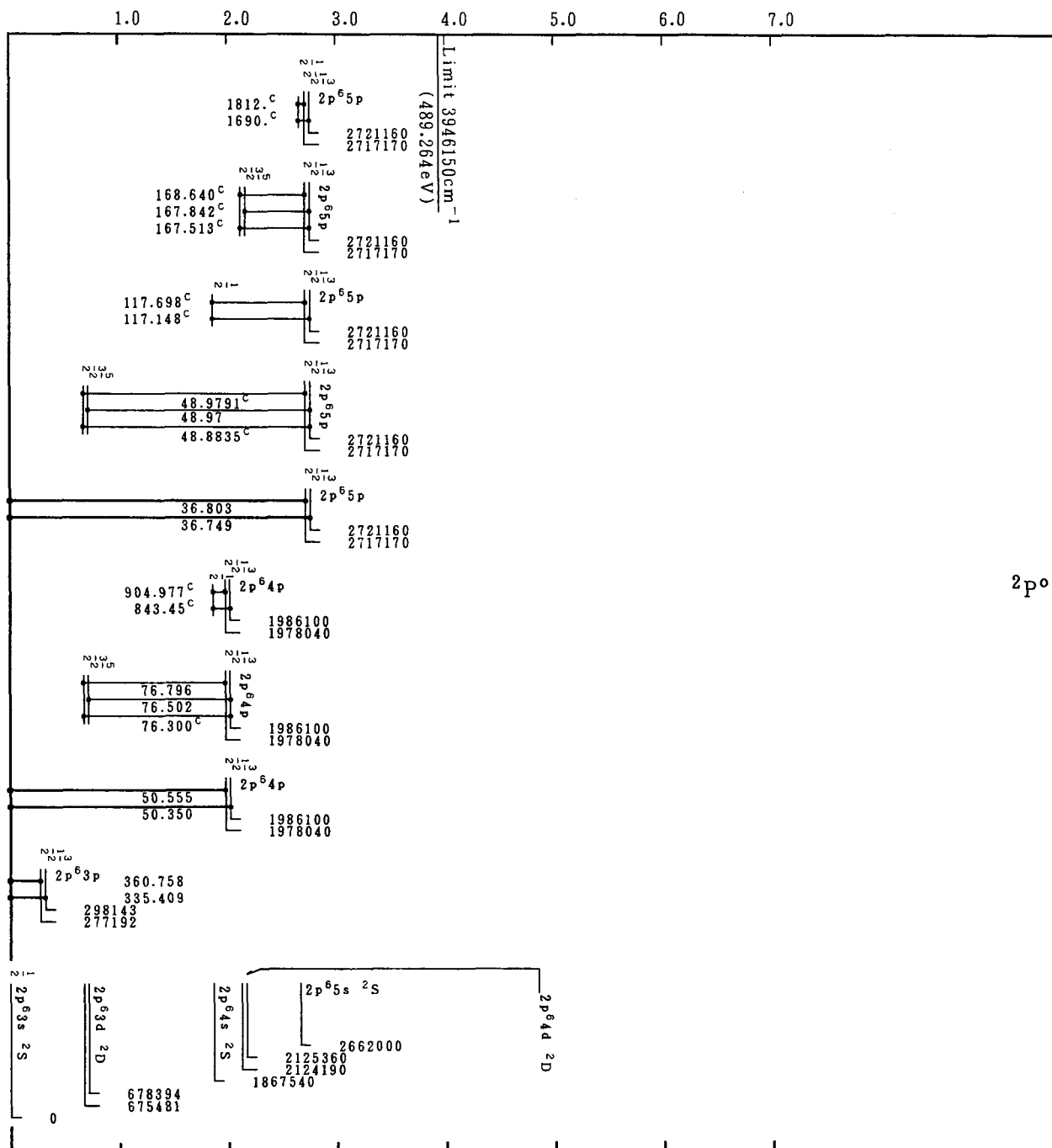

Grotrian Diagrams for Fe XVI (Na-Sequence)-Continued

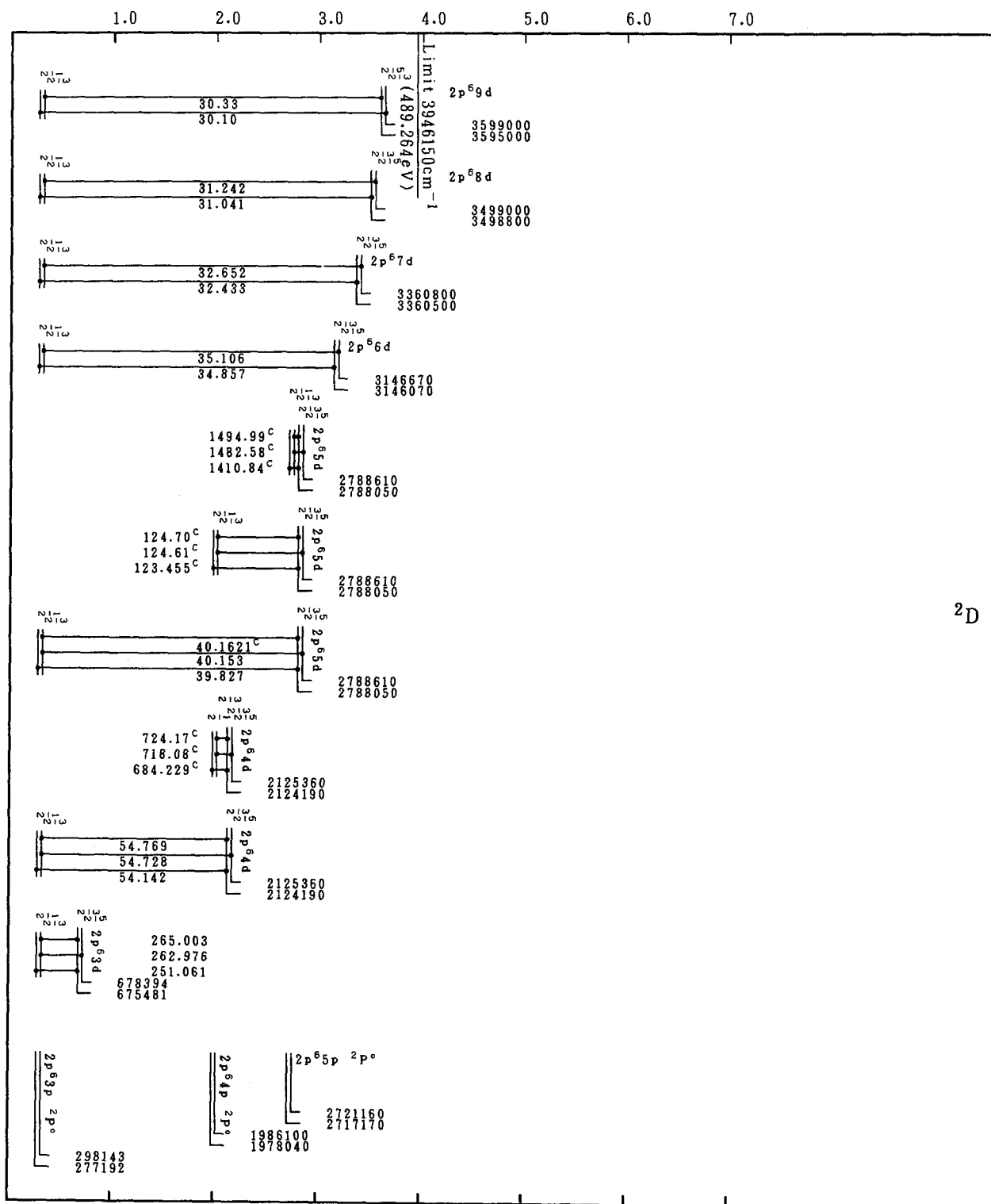
Energy (in 10^6cm^{-1})

Grotrian Diagrams for Fe XVI (Na-Sequence)-Continued

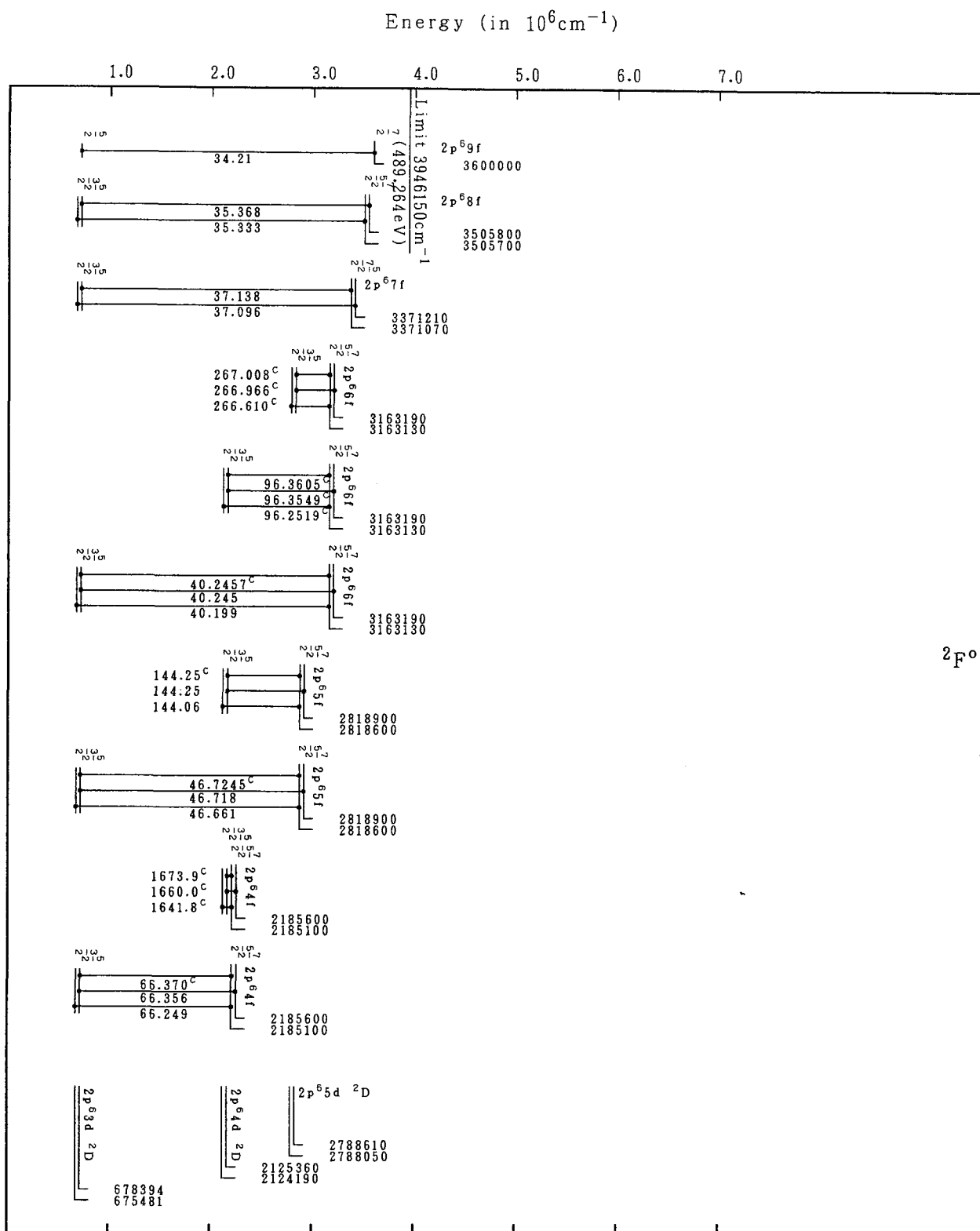

Grotrian Diagrams for Fe XVI (Na-Sequence)-Continued

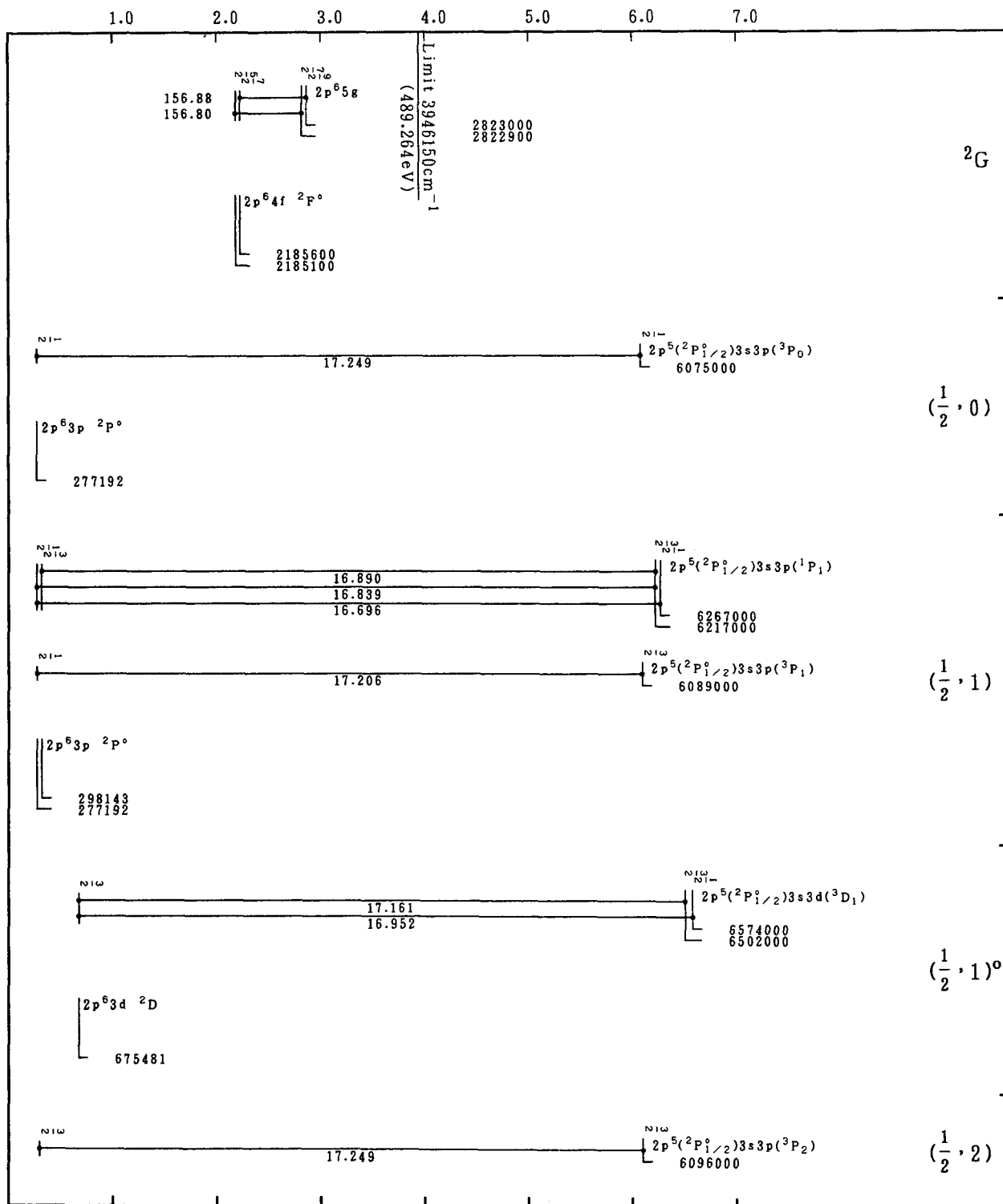
Energy (in 10^6cm^{-1})

Grotrian Diagrams for Fe XVI (Na-Sequence)-Continued

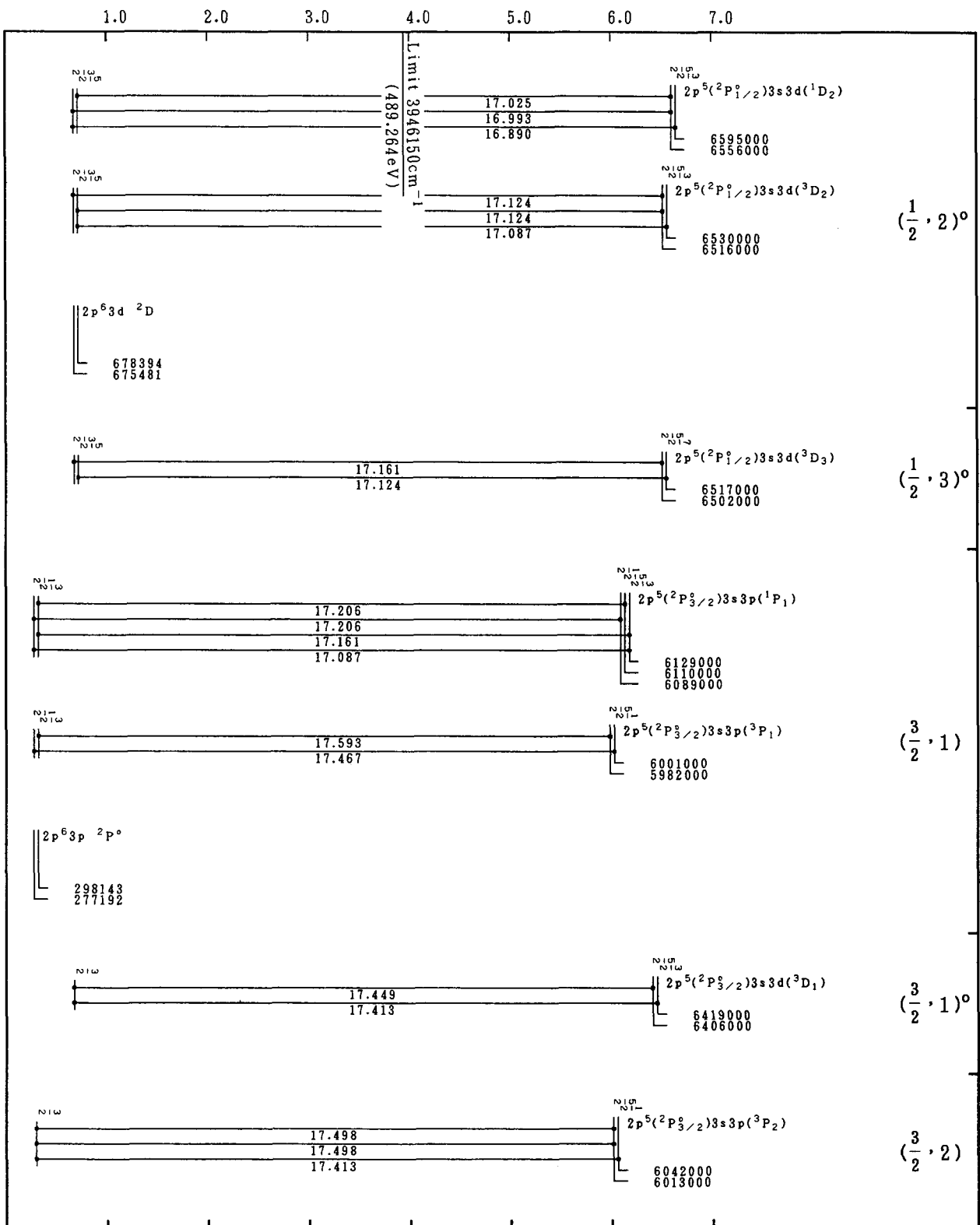
Energy (in 10^6cm^{-1})

Grotrian Diagrams for Fe XVI (Na-Sequence)-Continued

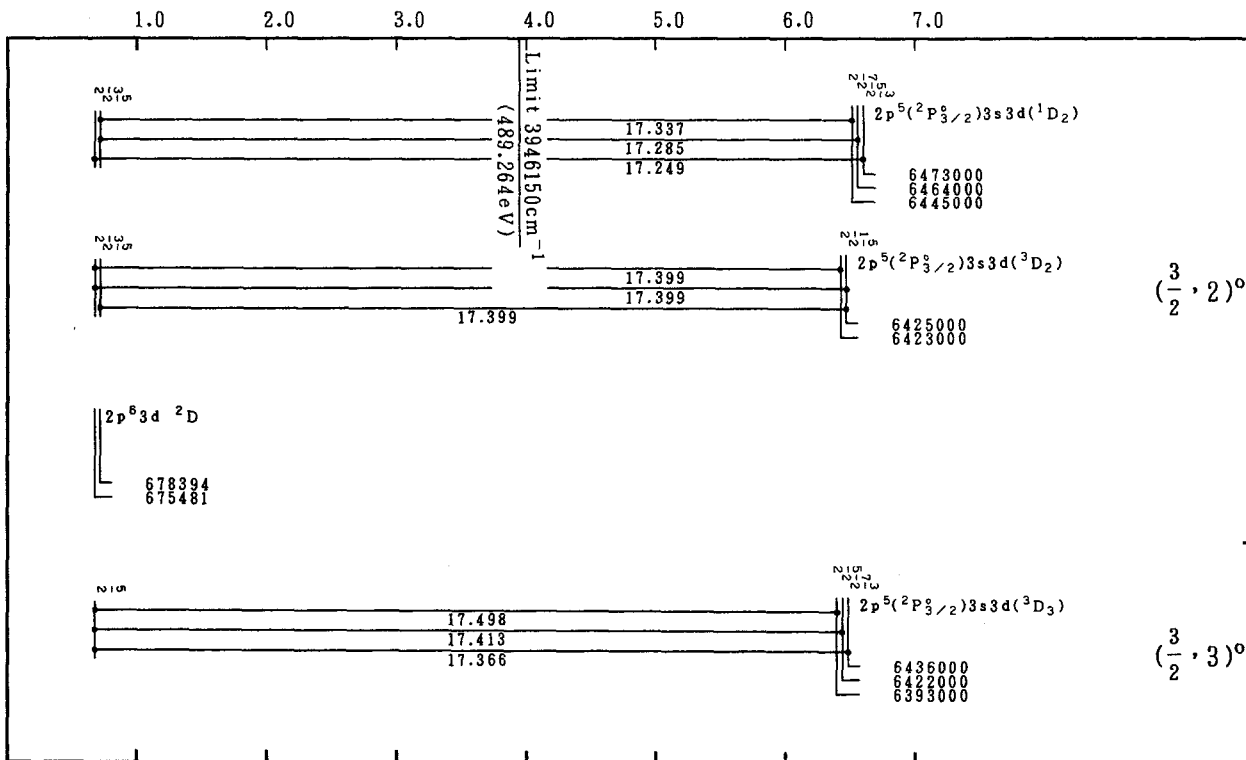
Energy (in 10^6cm^{-1})

Grotrian Diagrams for Fe XVI (Na-Sequence)-Continued

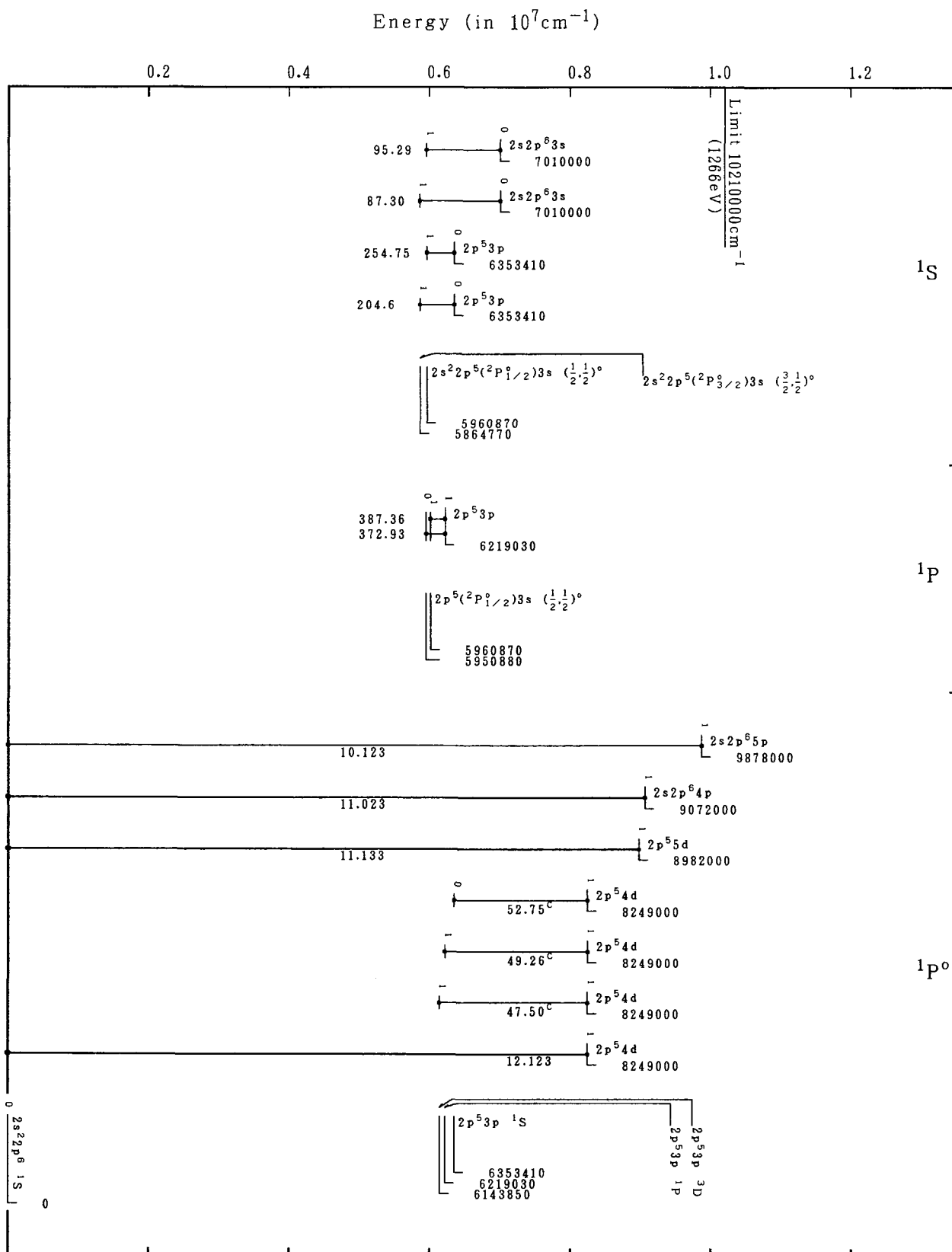

Grotrian Diagrams for Fe XVII (Ne-Sequence)

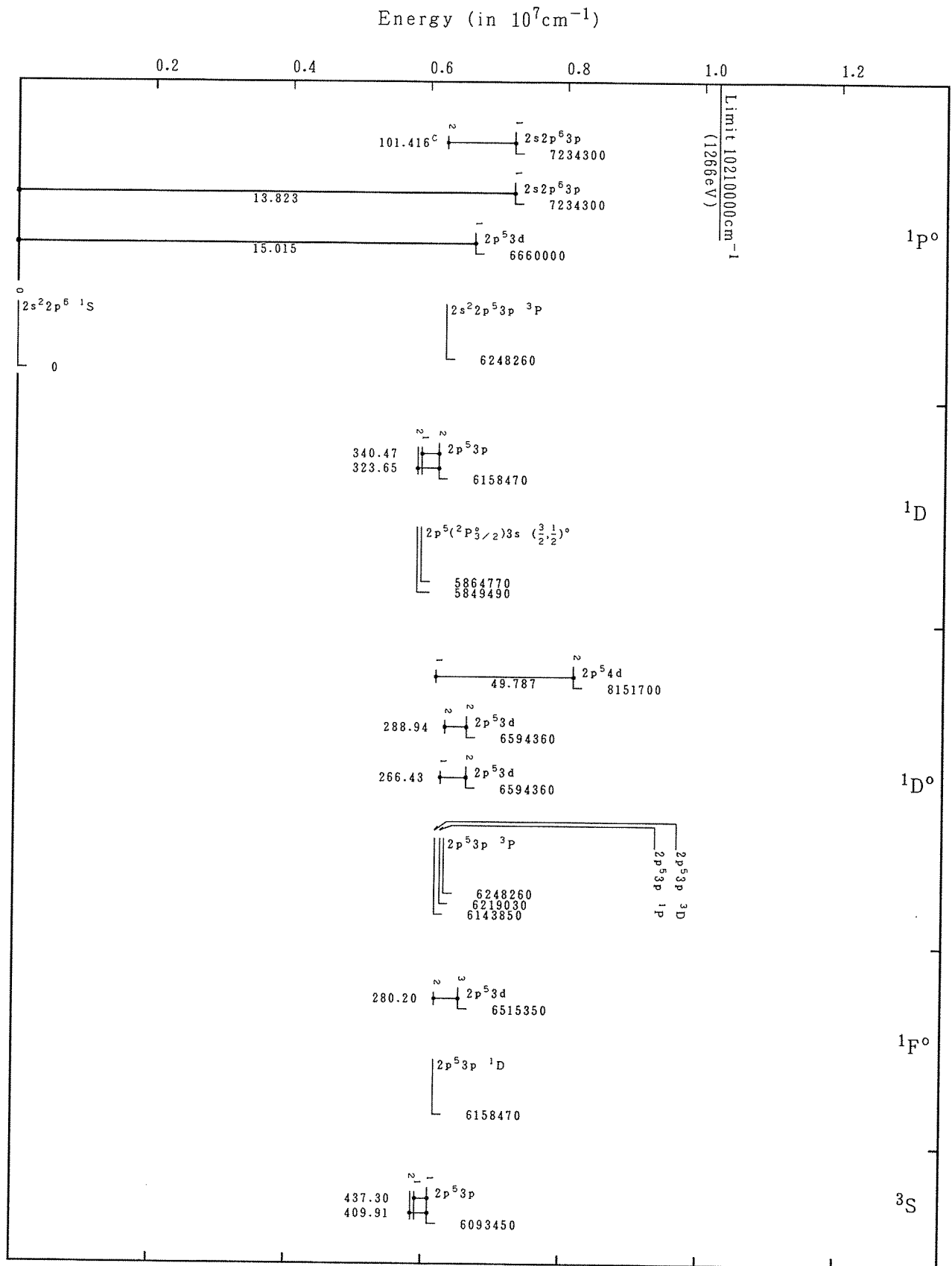

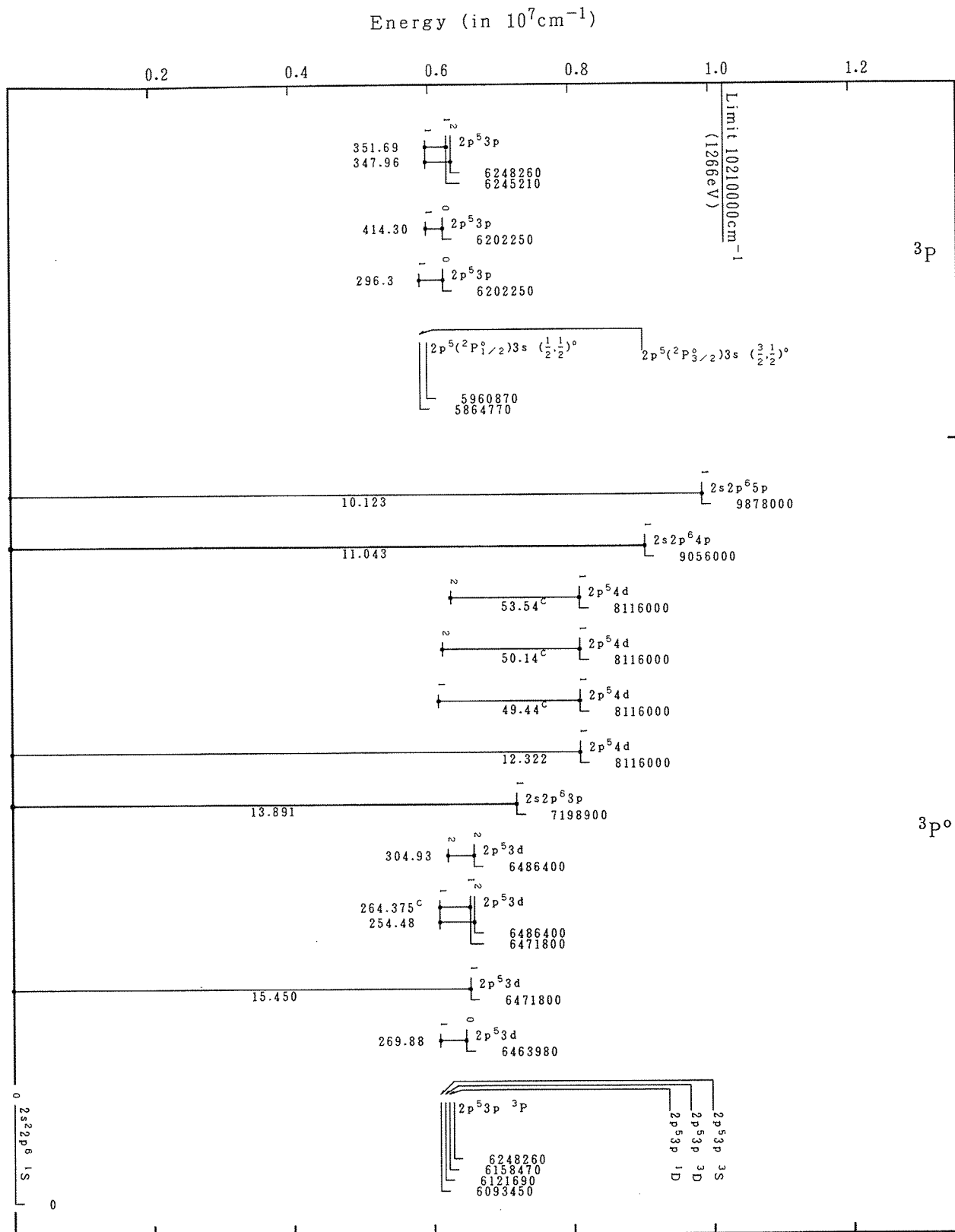

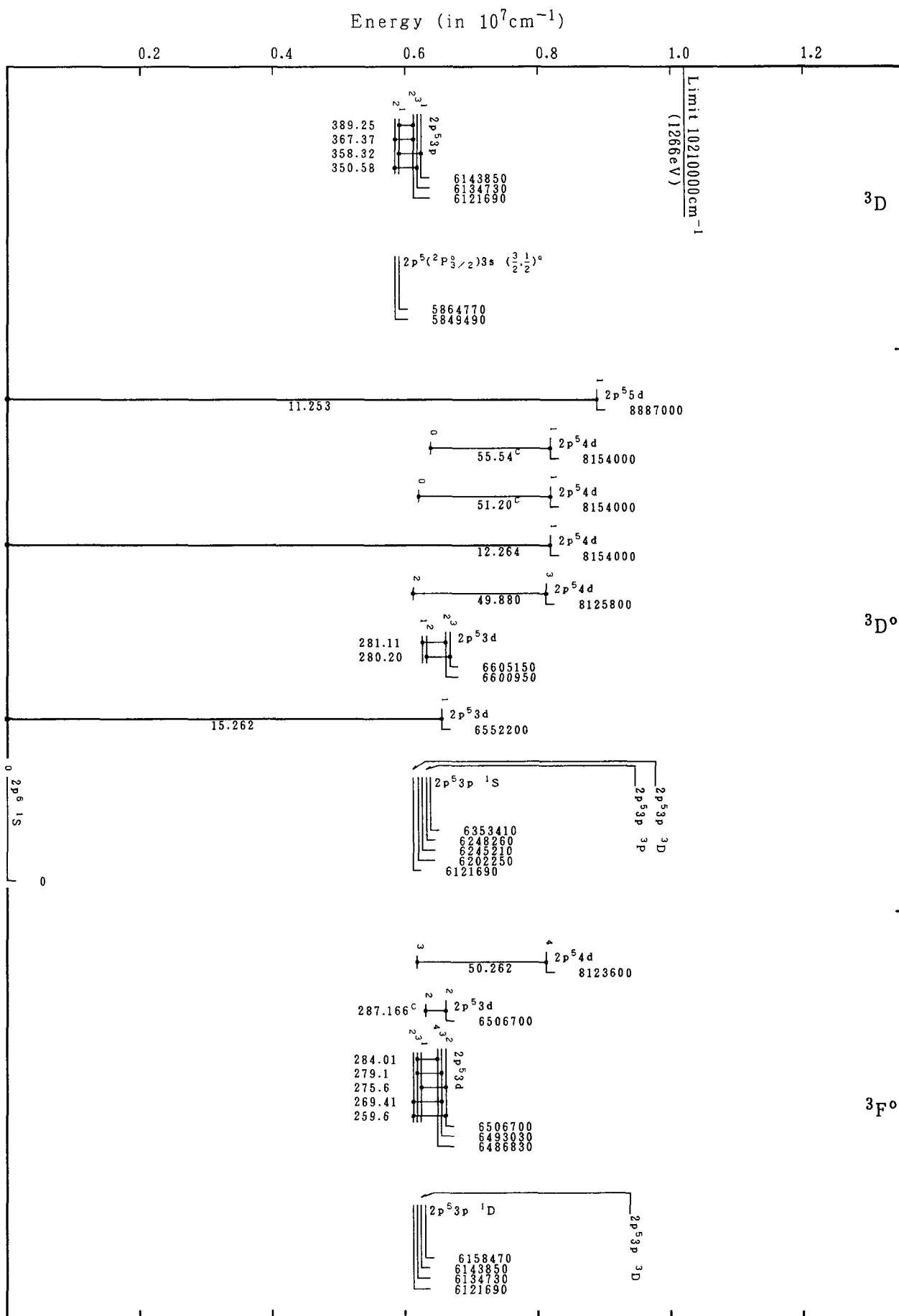

Grotrian Diagrams for Fe XVII (Ne-Sequence)-Continued

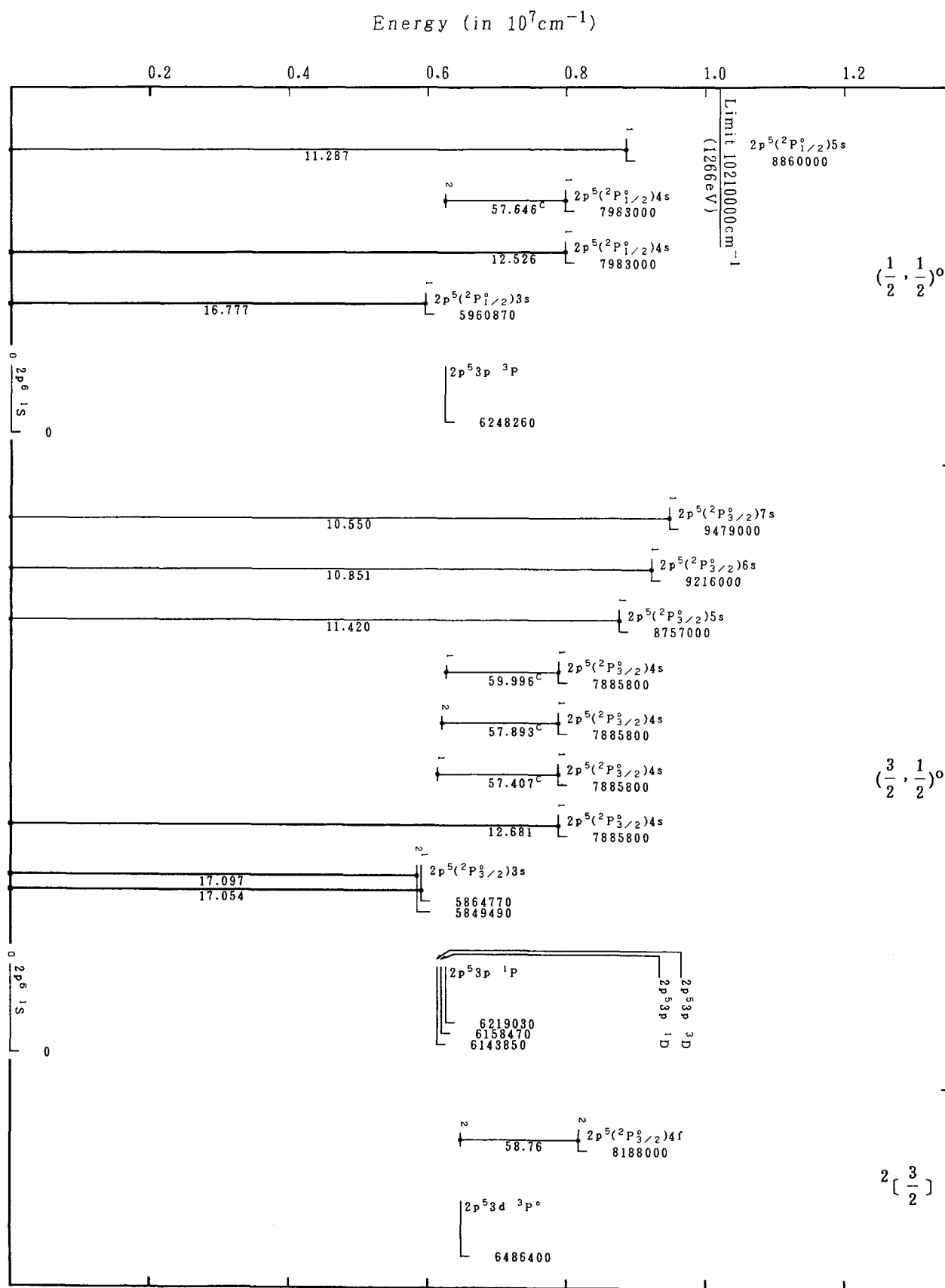

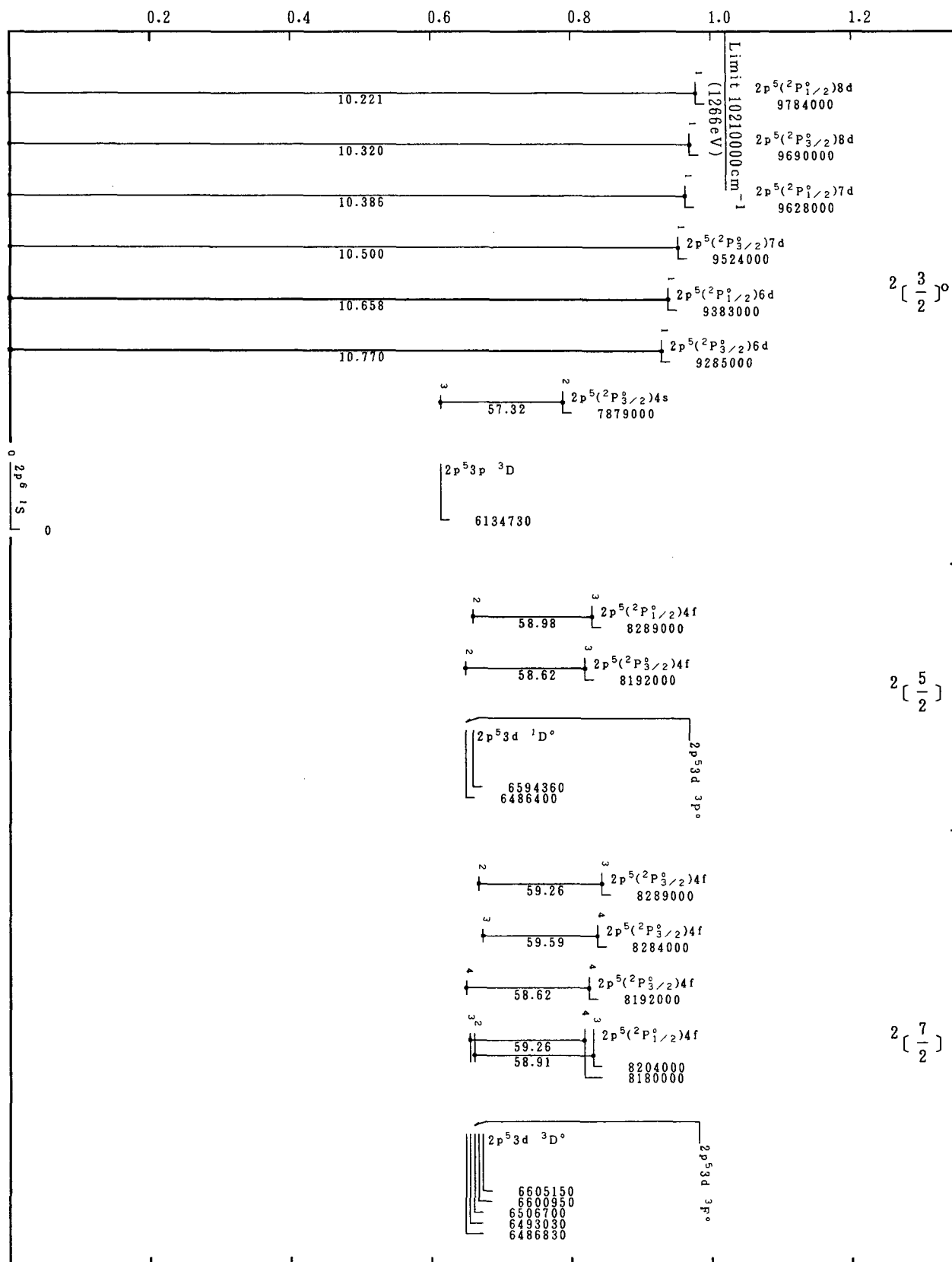
Energy (in 10^7cm^{-1})

Grotrian Diagrams for Fe XVII (Ne-Sequence)-Continued

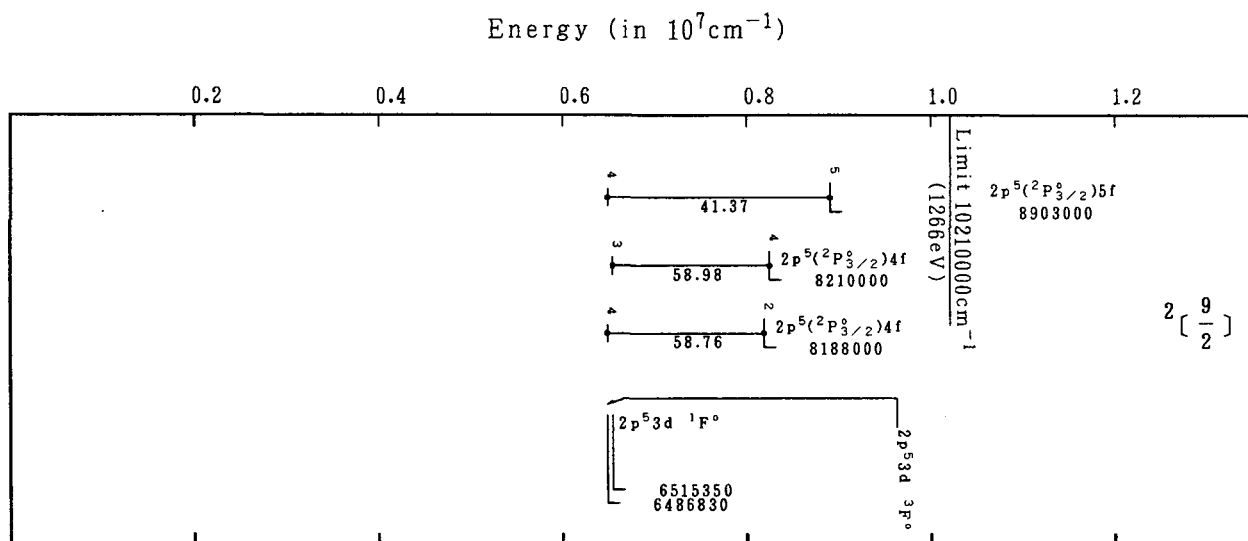

Grotrian Diagrams for Fe XVII (Ne-Sequence)-Continued

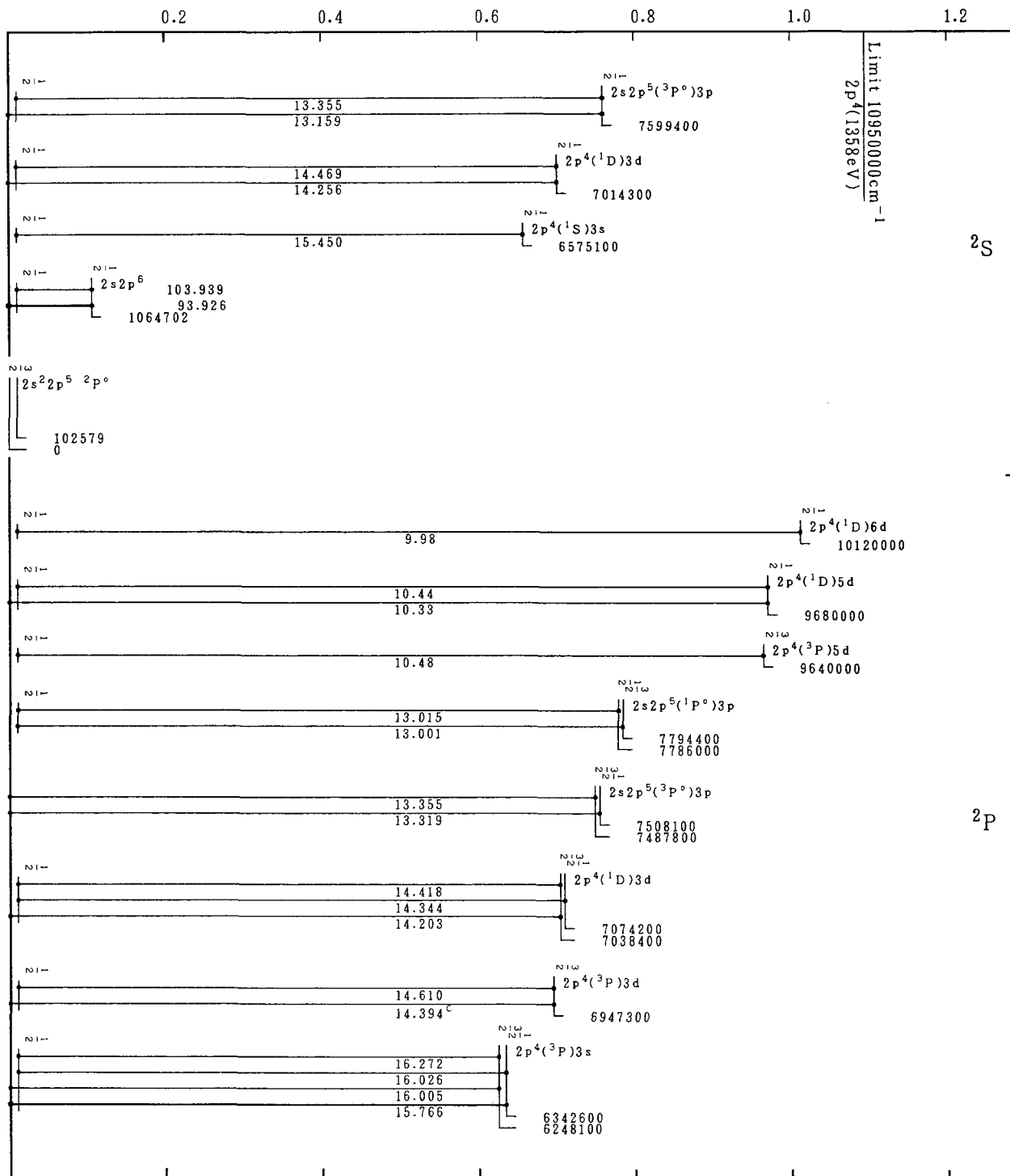
Energy (in 10^7cm^{-1})

Grotrian Diagrams for Fe XVIII (F-Sequence)

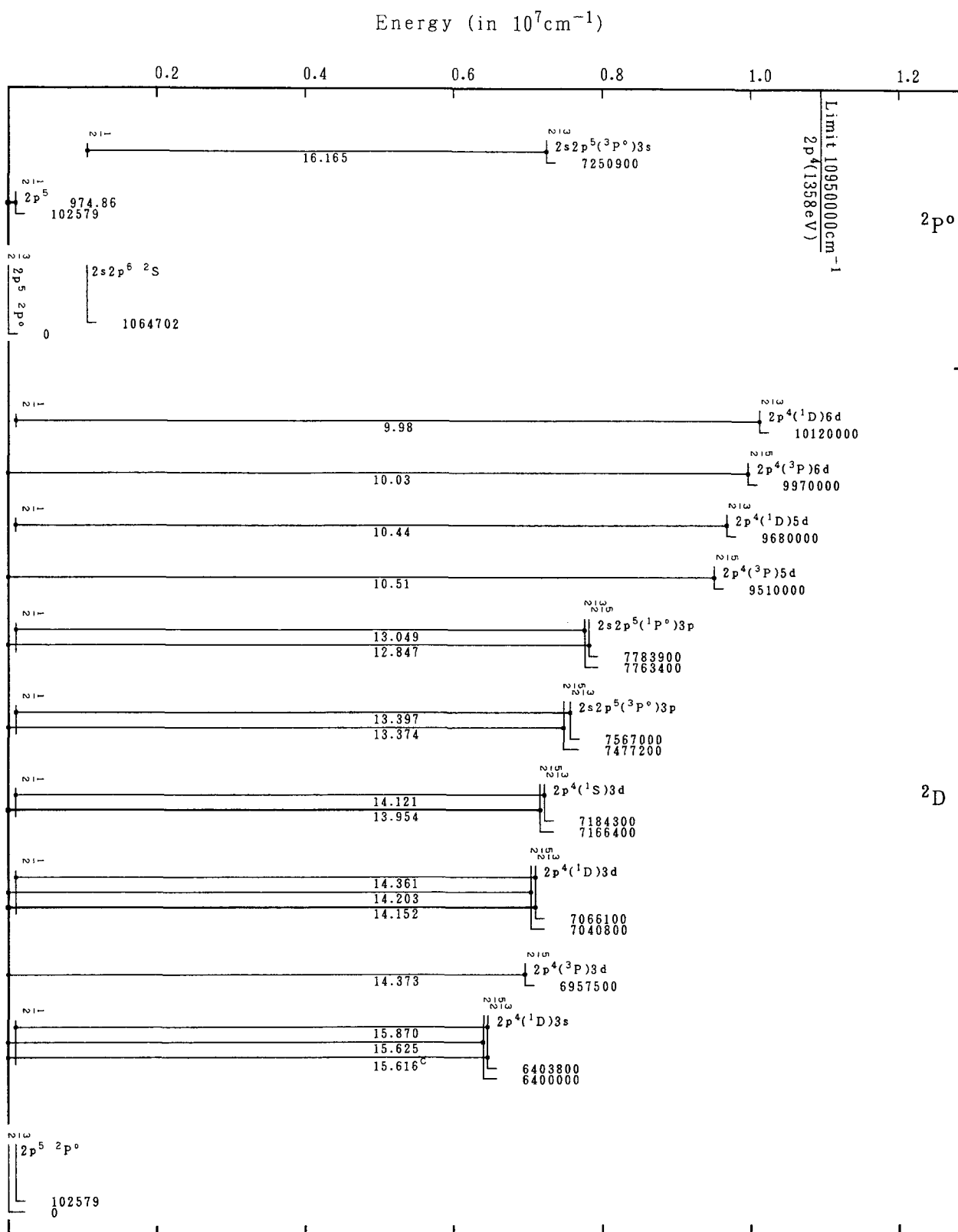

Grotrian Diagrams for Fe XVIII (F-Sequence)-Continued

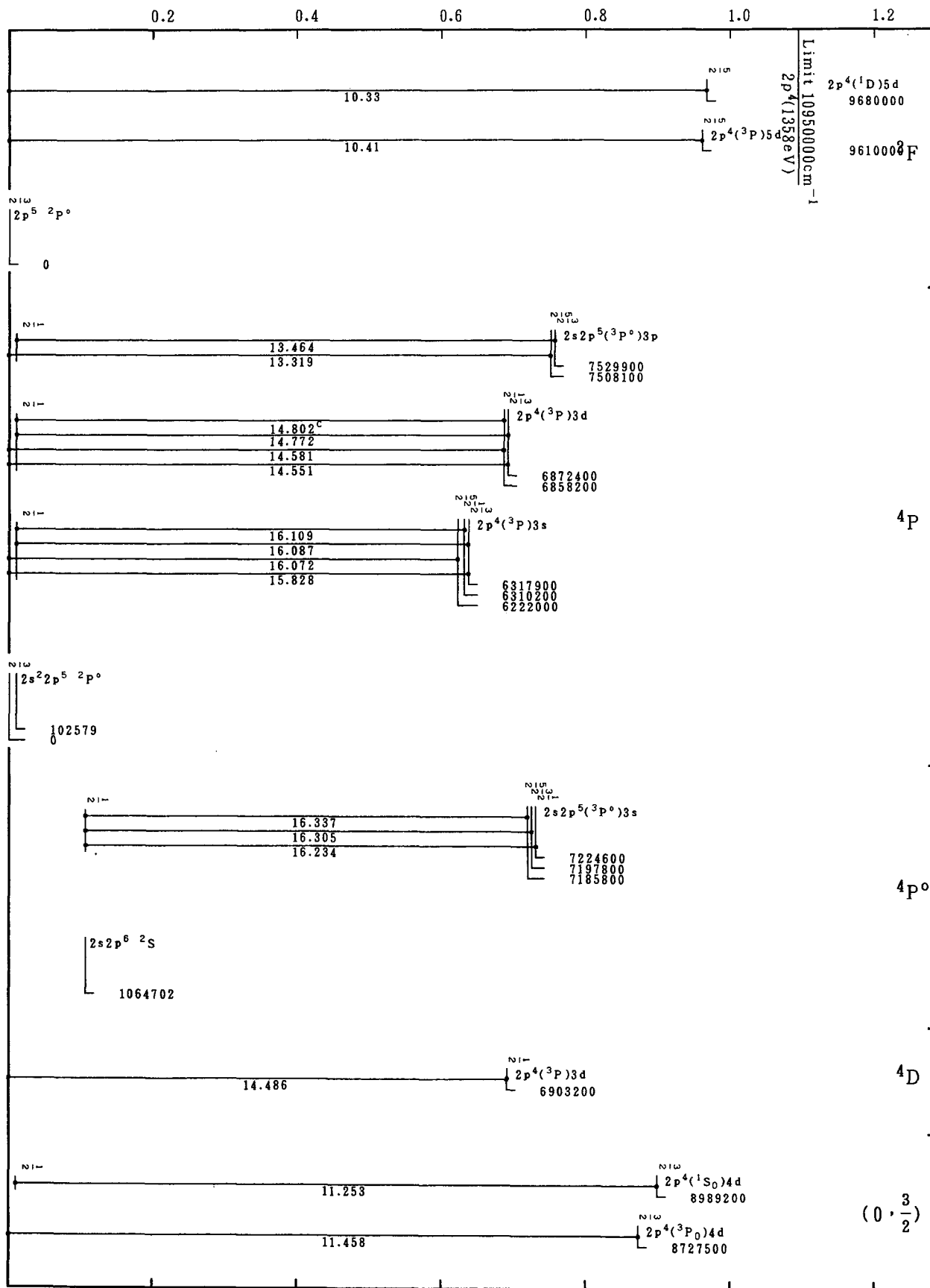
Energy (in 10^7cm^{-1})

Grotrian Diagrams for Fe XVIII (F-Sequence)-Continued

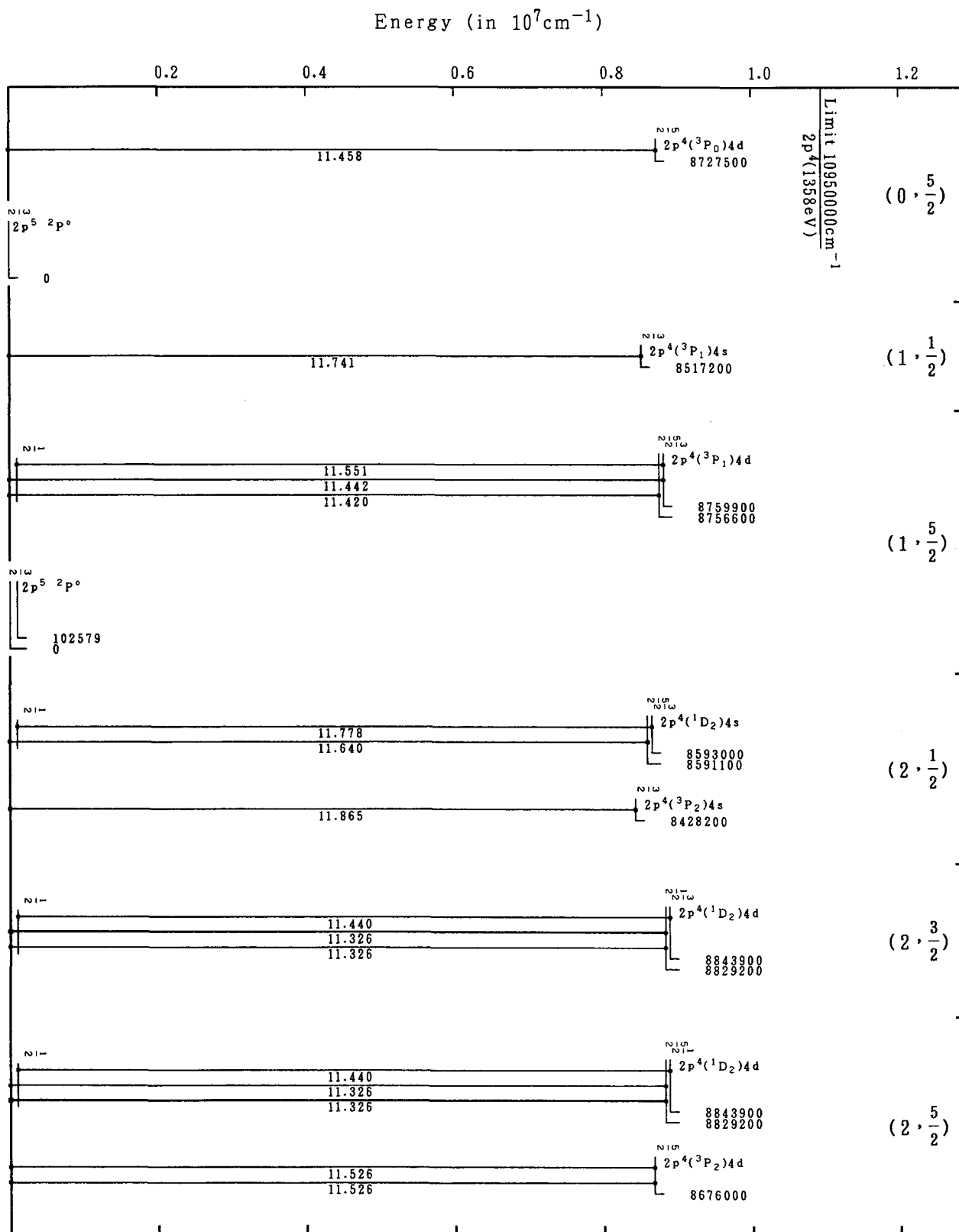

Grotrian Diagrams for Fe XVIII (F-Sequence)-Continued

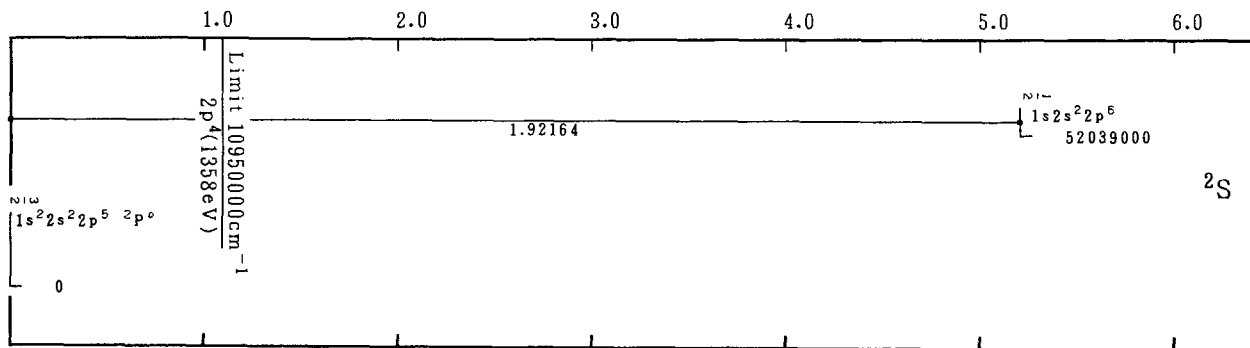
Energy (in 10^7cm^{-1})

Grotrian Diagrams for Fe XVIII (F-Sequence)-Continued

Energy (in 10^7cm^{-1})

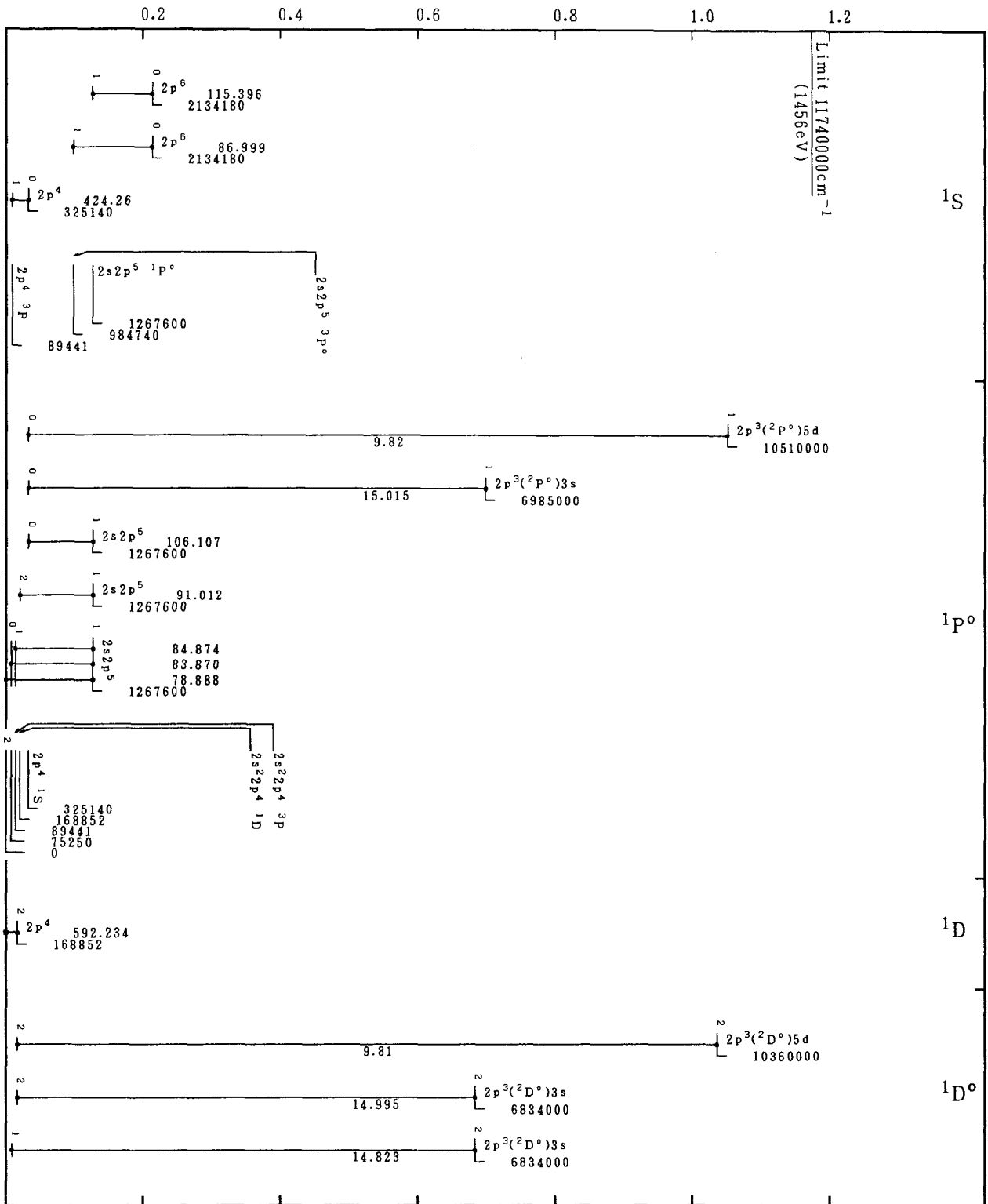

Grotrian Diagrams for Fe XIX (O-Sequence)

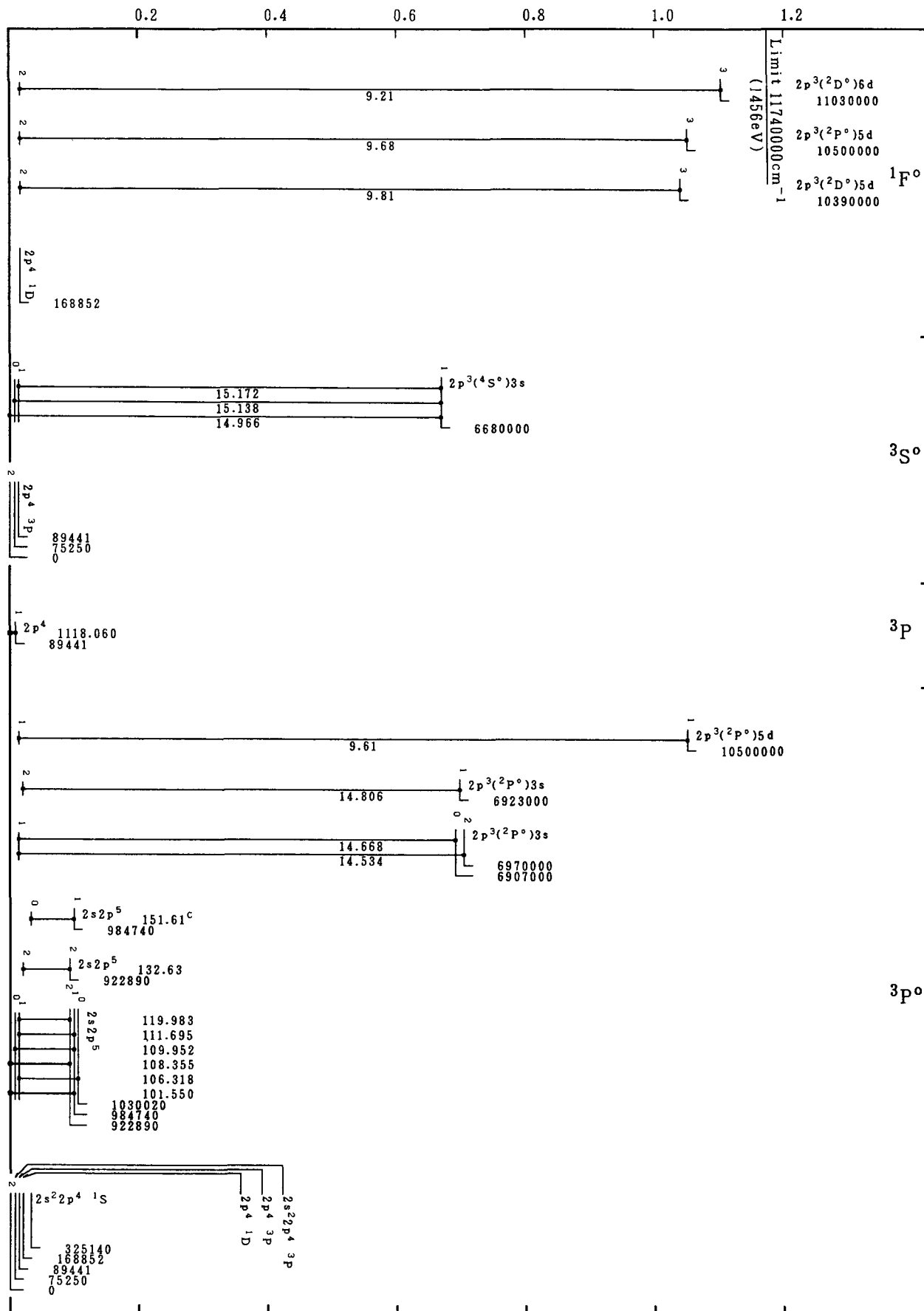
Energy (in 10^7cm^{-1})

Grotrian Diagrams for Fe XIX (O-Sequence)-Continued

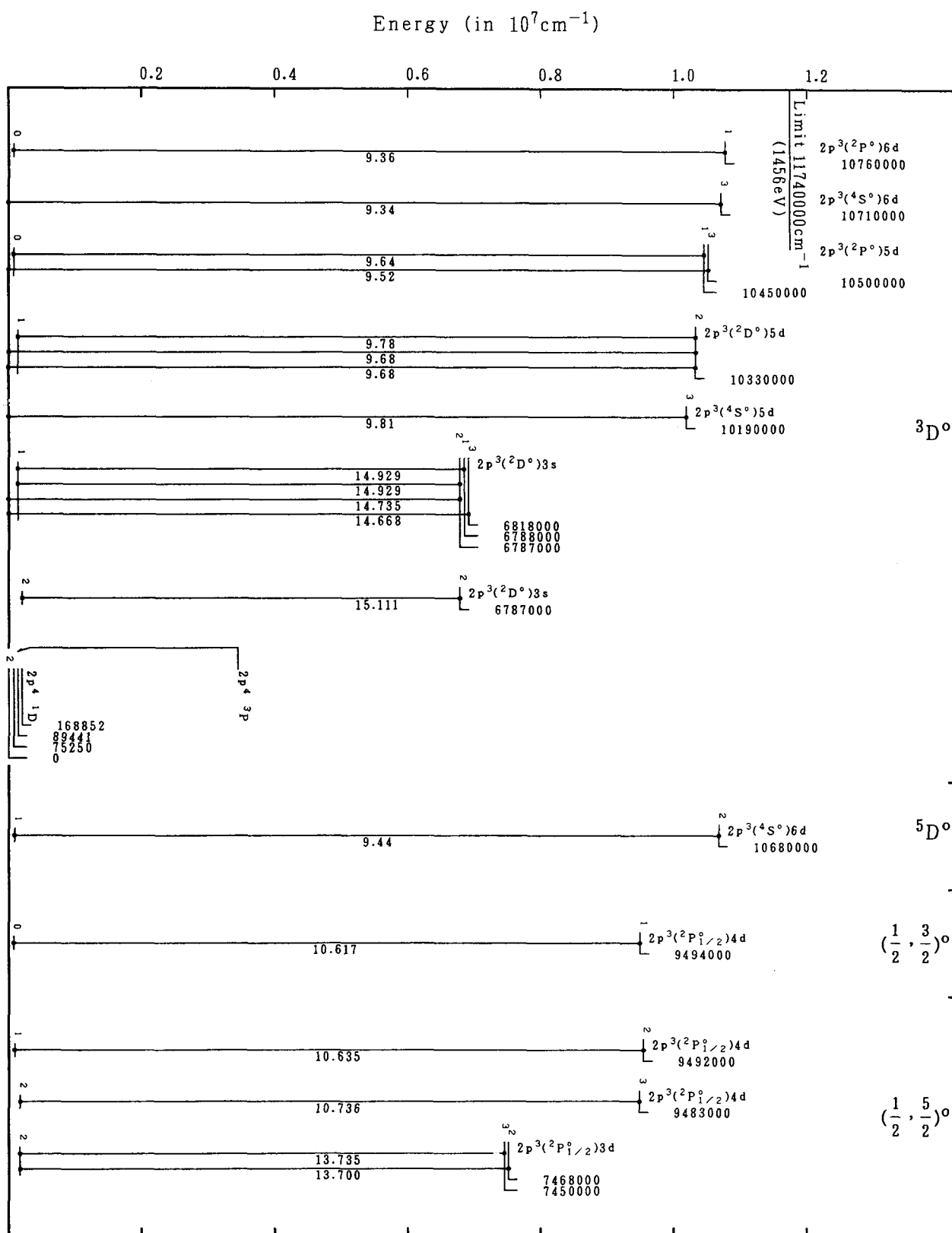

Grotrian Diagrams for Fe XIX (O-Sequence)-Continued

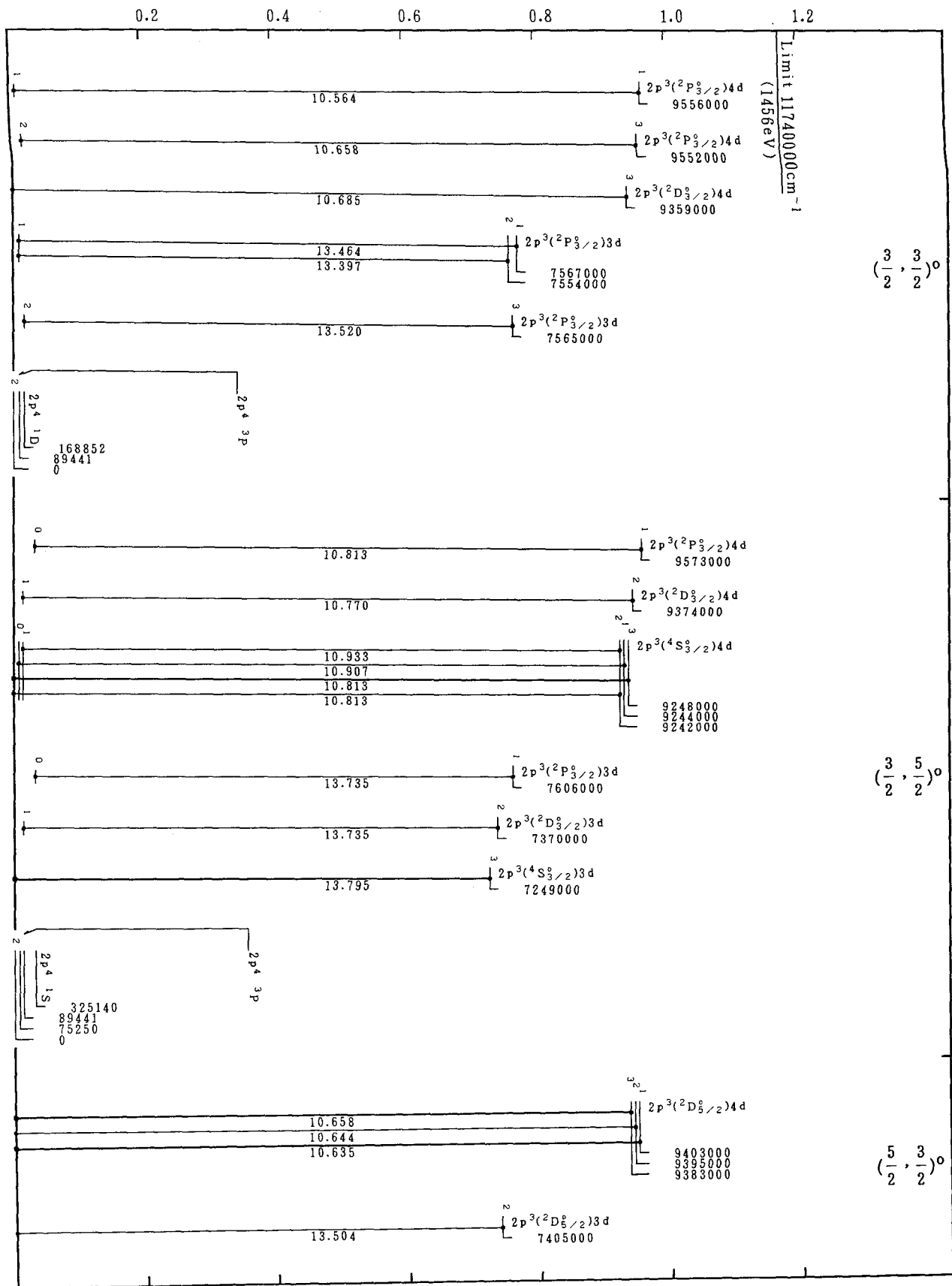
Energy (in 10^7cm^{-1})

Grotrian Diagrams for Fe XIX (O-Sequence)-Continued

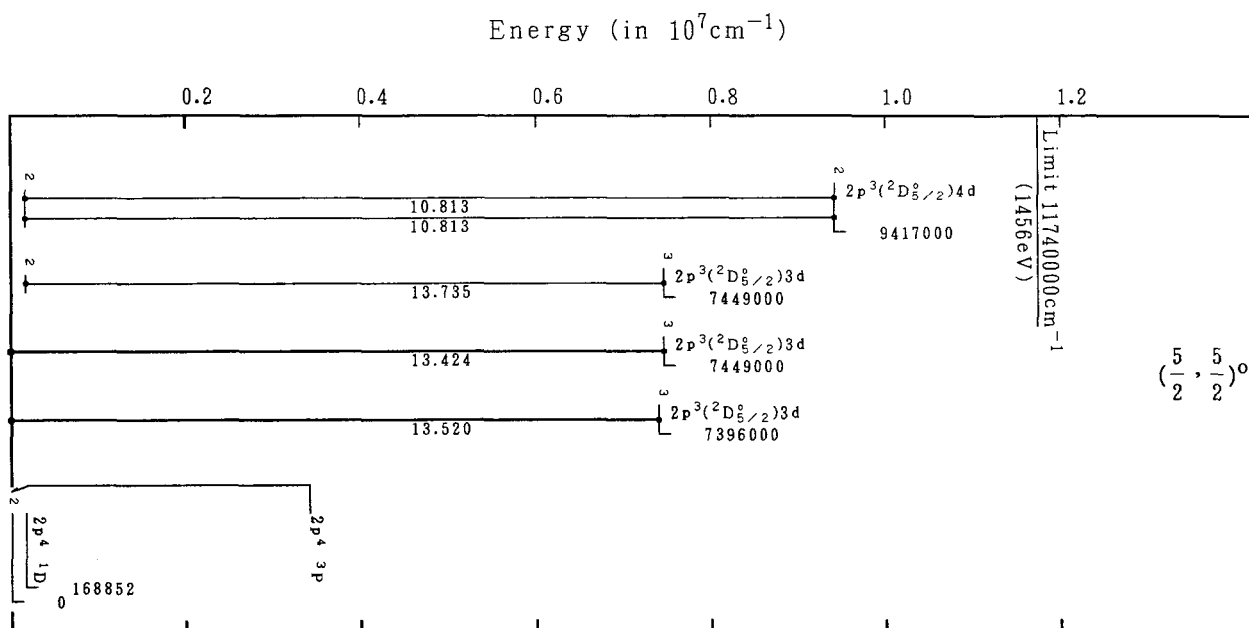

Grotrian Diagrams for Fe XIX (O-Sequence)-Continued

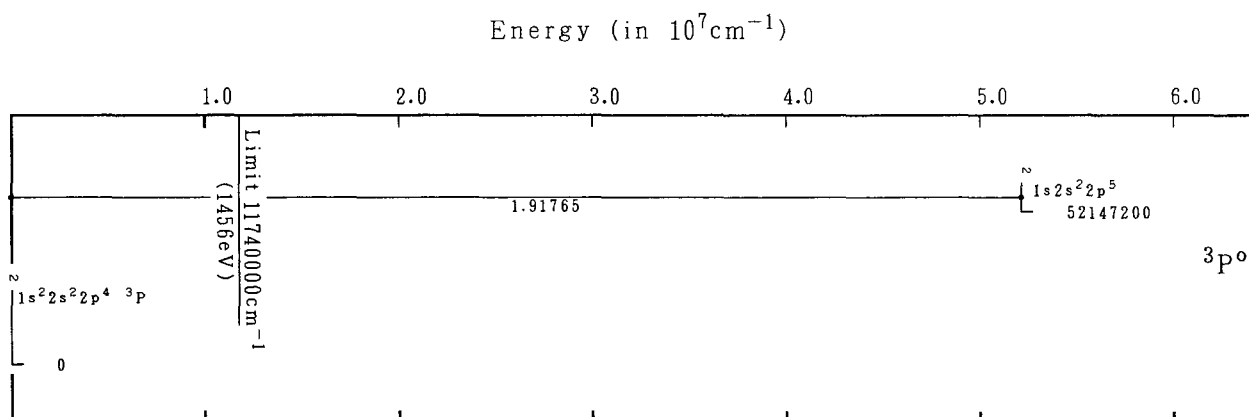

Grotrian Diagrams for Fe XIX (O-Sequence)-Continued

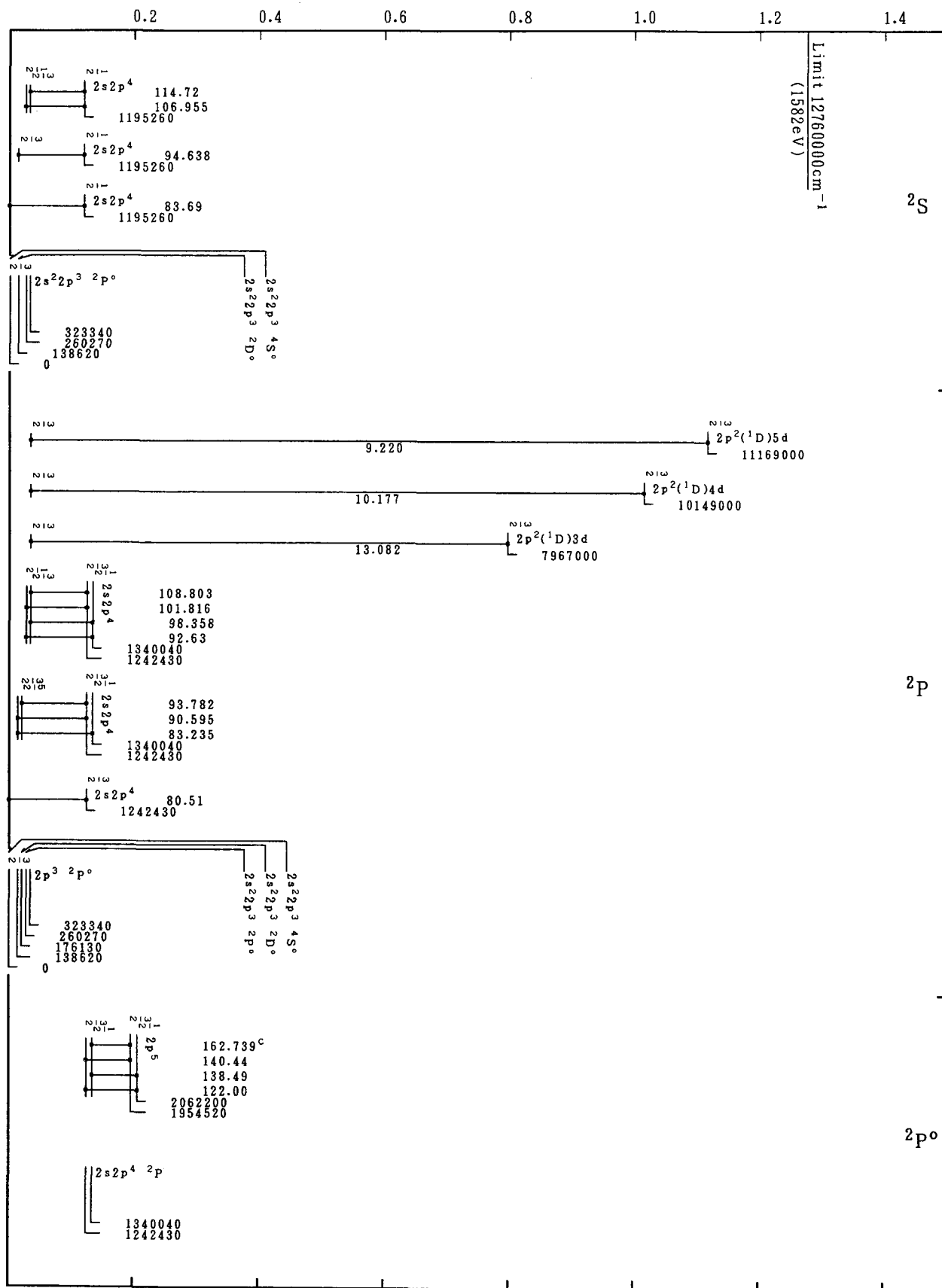
Energy (in 10^7cm^{-1})

Grotrian Diagrams for Fe XX (N-Sequence)

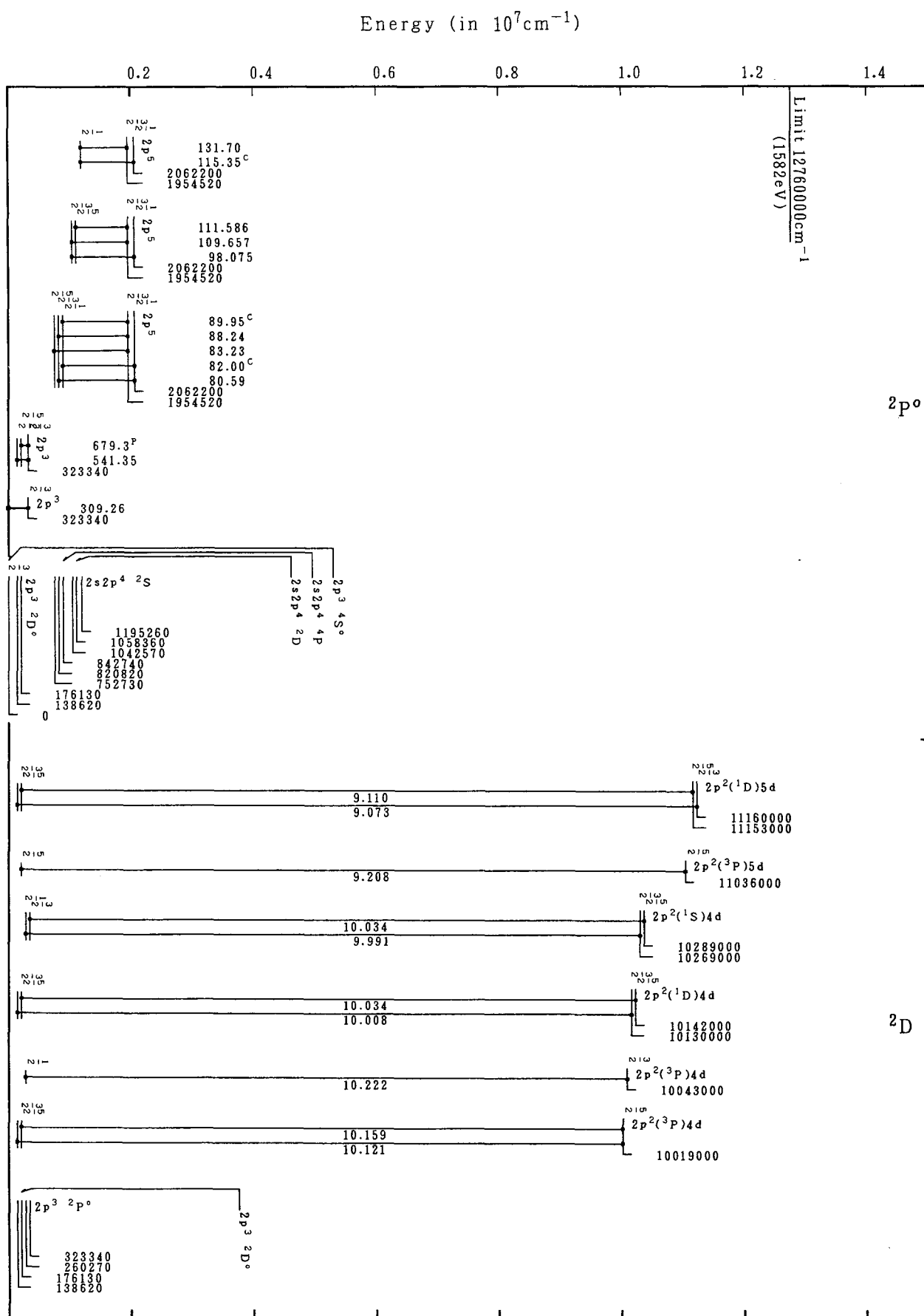

Grotrian Diagrams for Fe XX (N-Sequence)-Continued

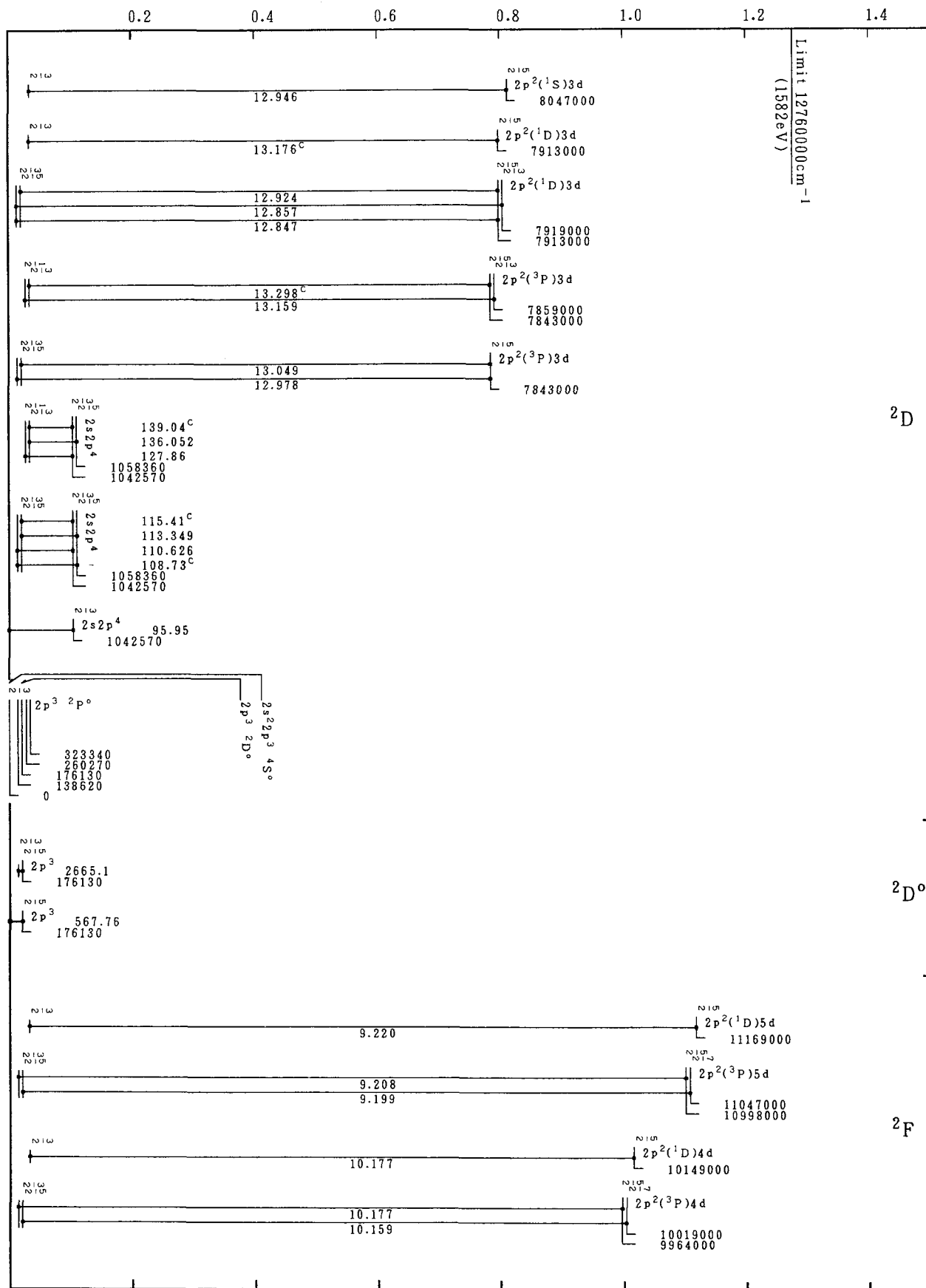
Energy (in 10^7cm^{-1})

Grotrian Diagrams for Fe XX (N-Sequence)-Continued

Energy (in 10^7cm^{-1})

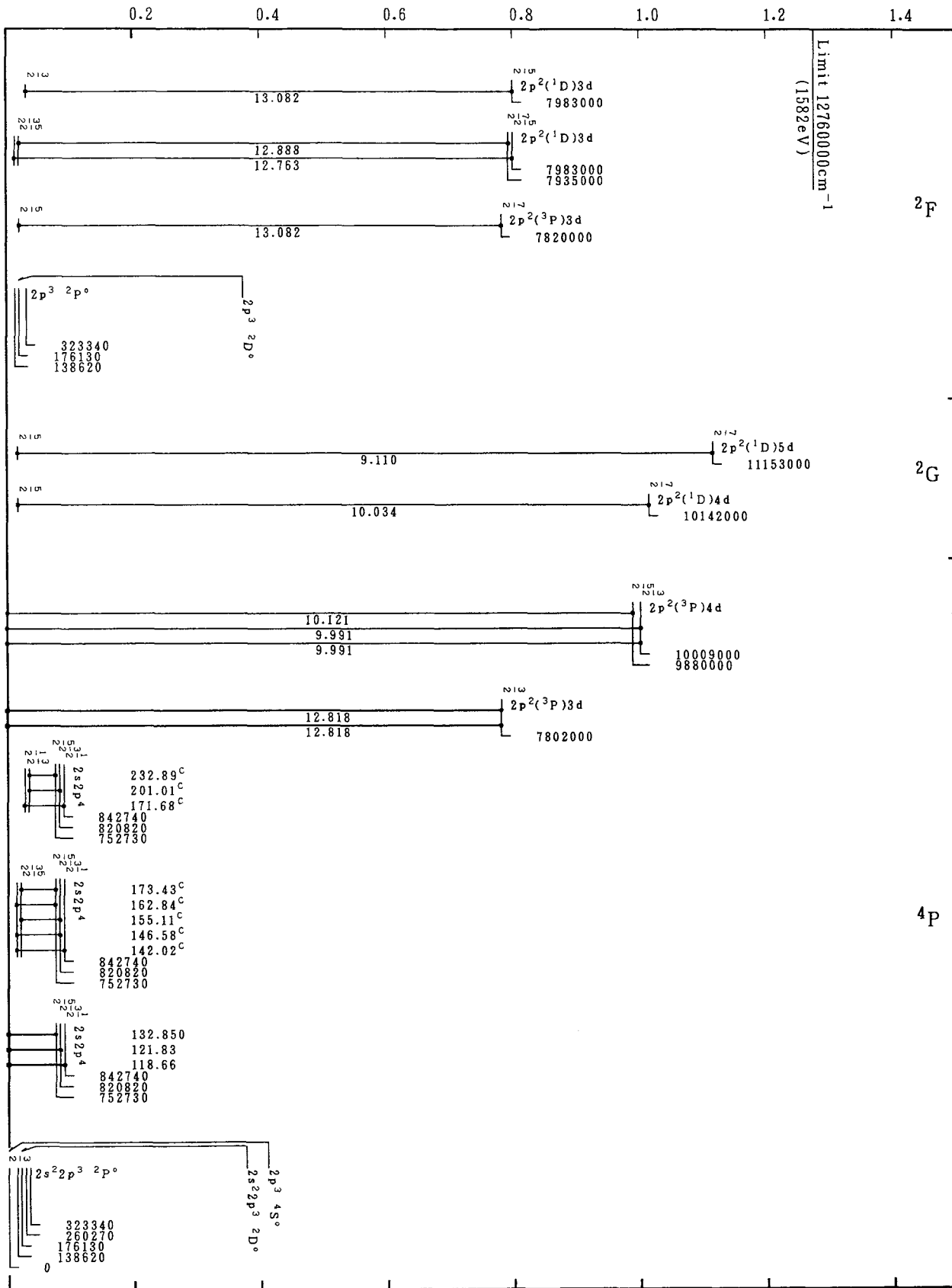

Grotrian Diagrams for Fe XX (N-Sequence)-Continued

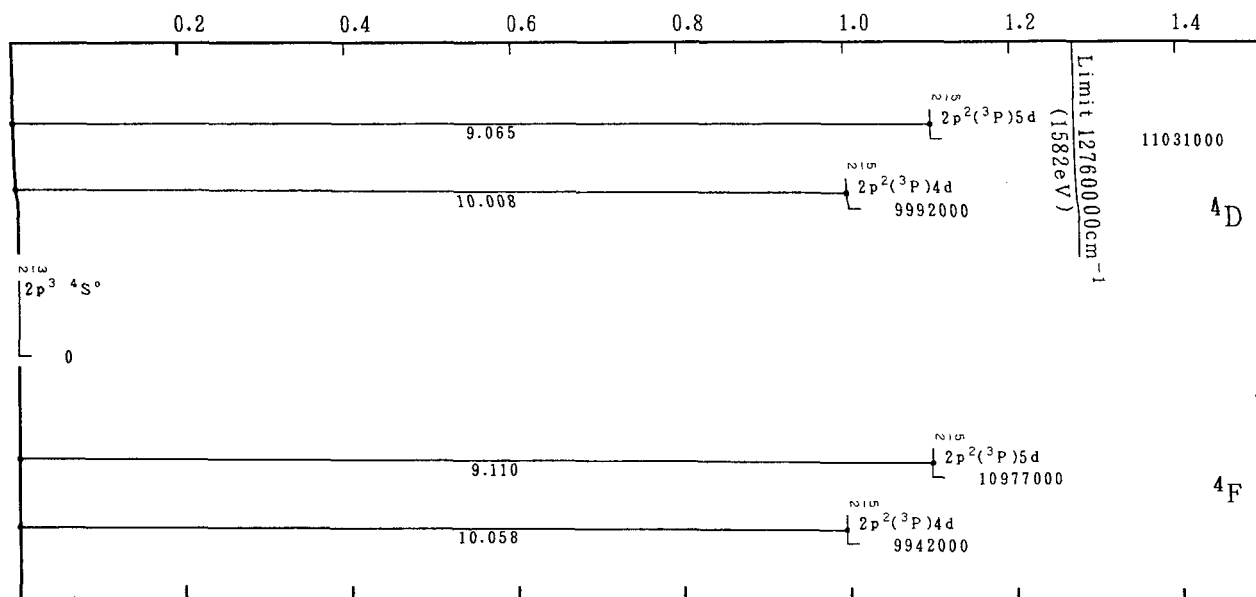
Energy (in 10^7cm^{-1})

Grotrian Diagrams for Fe XX (N-Sequence)-Continued

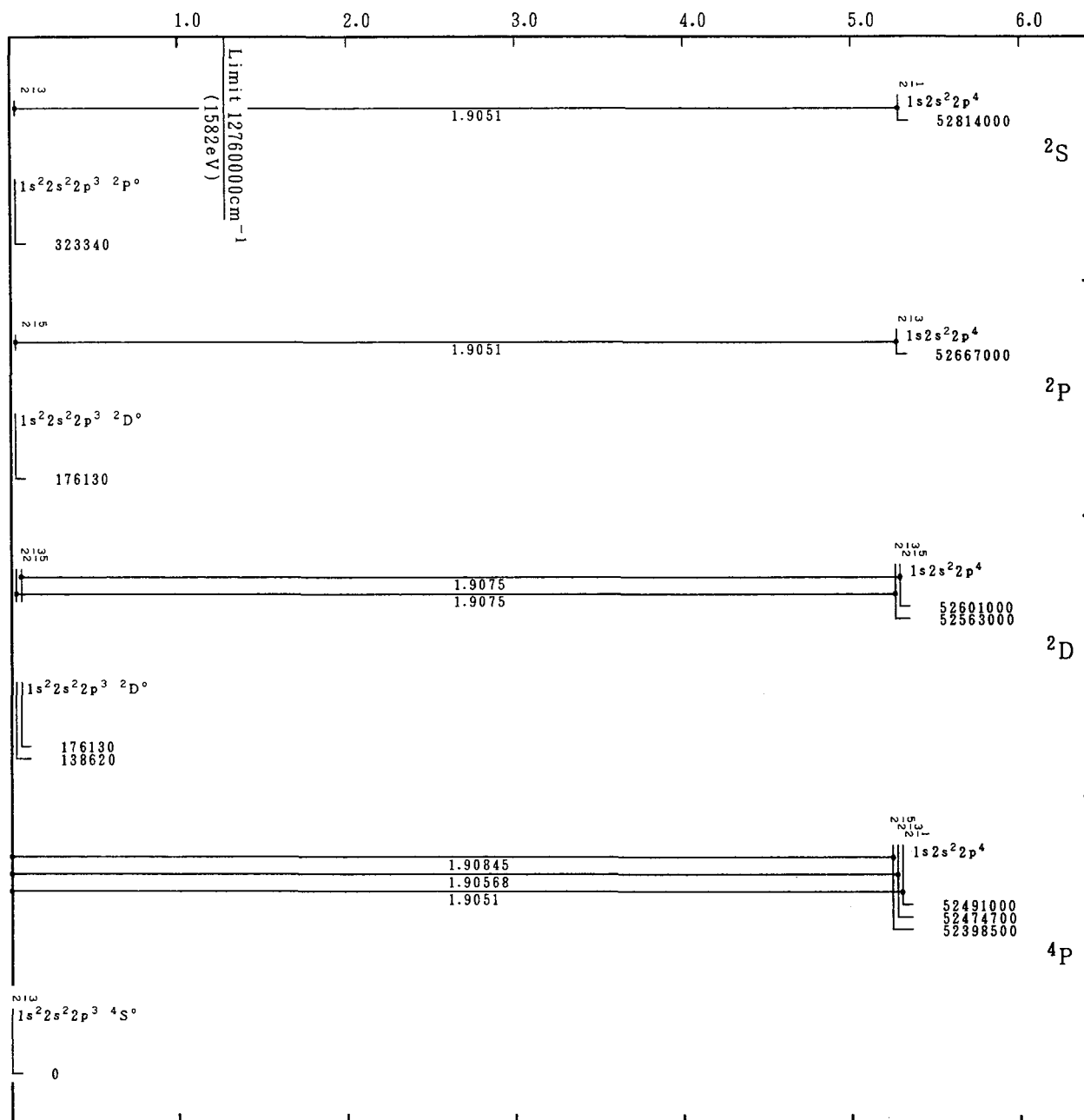
Energy (in 10^7cm^{-1})

Grotrian Diagrams for Fe XX (N-Sequence)-Continued

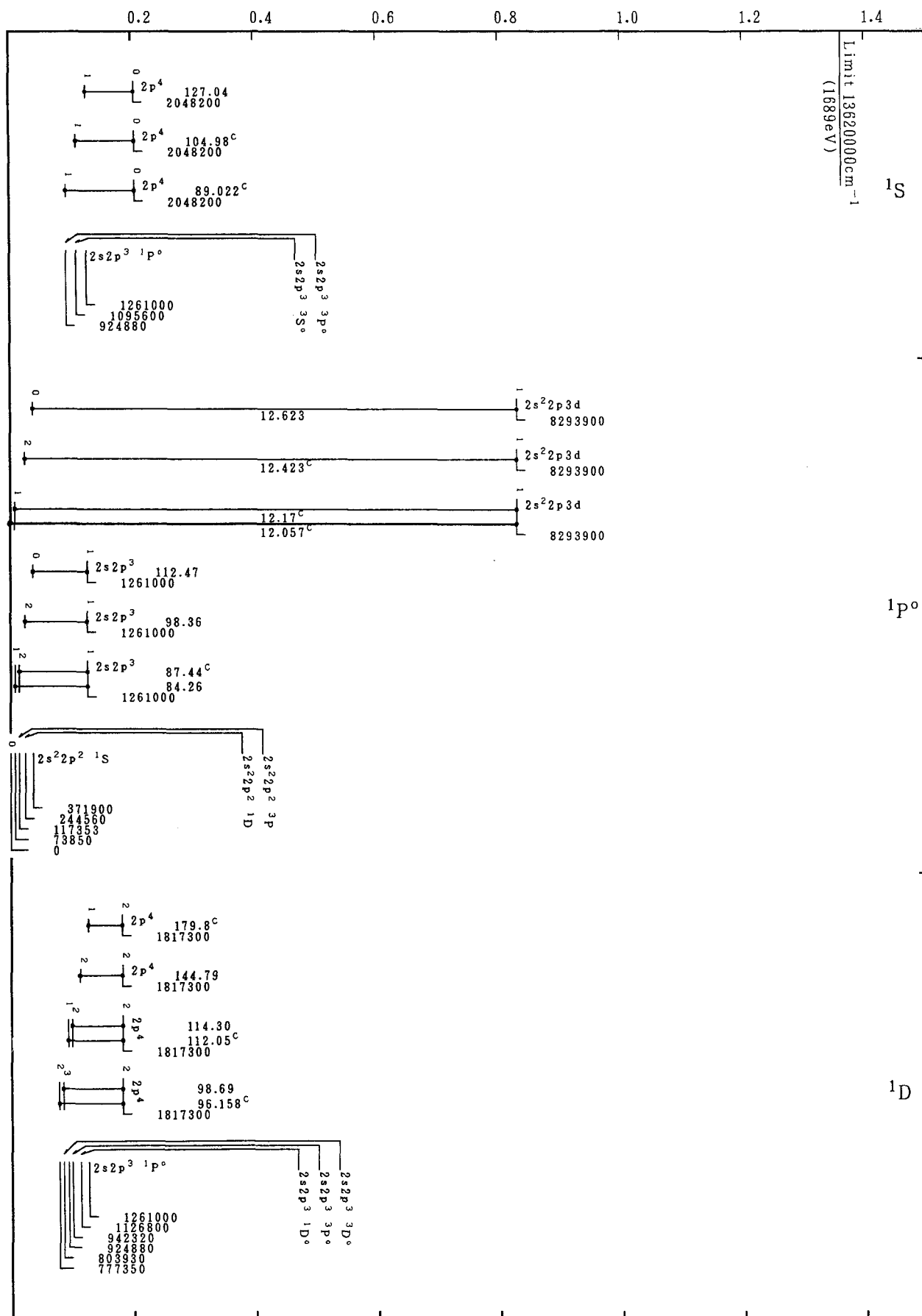
Energy (in 10^7cm^{-1})

Grotrian Diagrams for Fe XXI (C-Sequence)

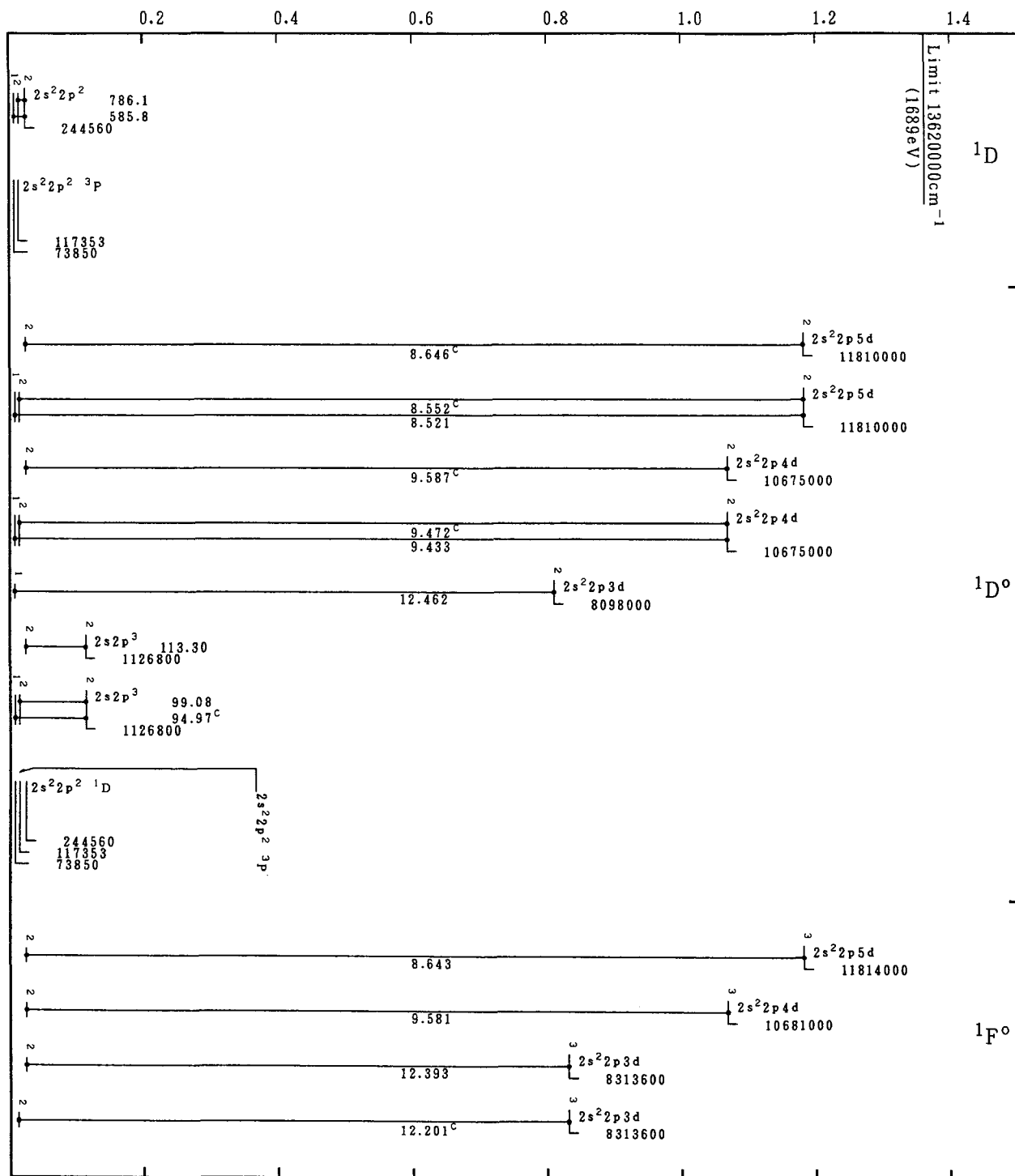
Energy (in 10^7cm^{-1})

Grotrian Diagrams for Fe XXI (C-Sequence)-Continued

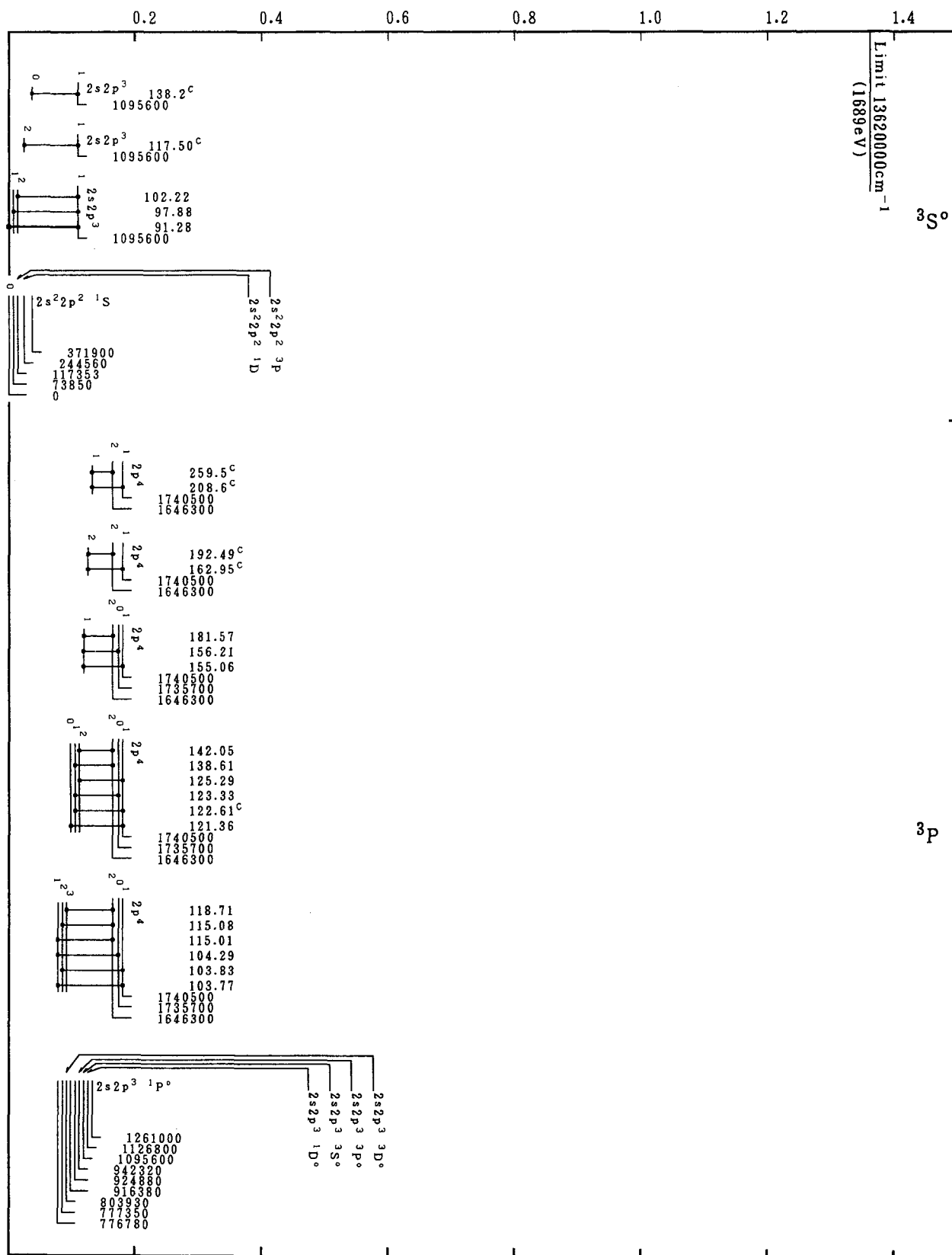
Energy (in 10^7cm^{-1})

Grotrian Diagrams for Fe XXI (C-Sequence)-Continued

Energy (in 10^7cm^{-1})

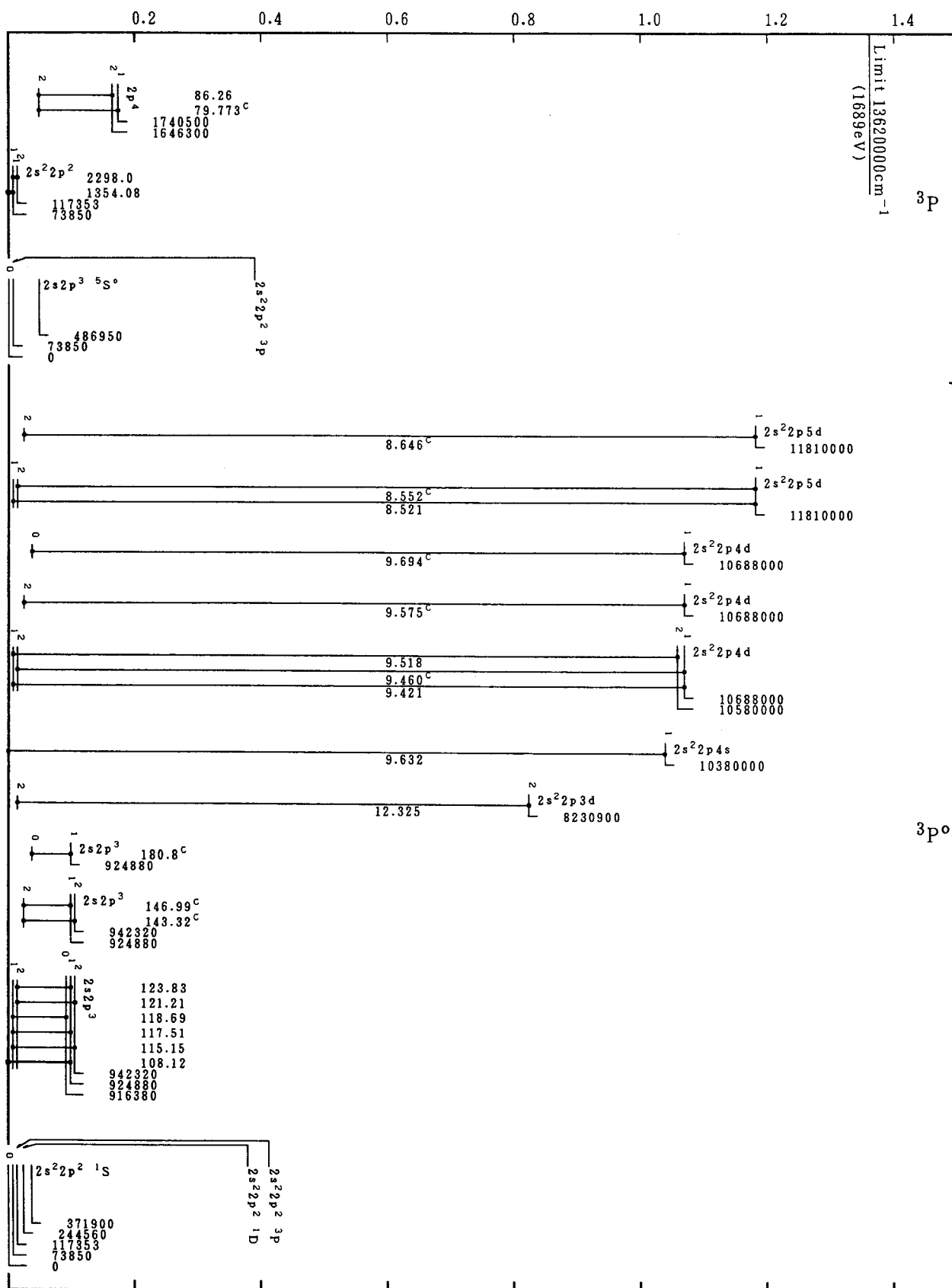

Grotrian Diagrams for Fe XXI (C-Sequence)-Continued

Energy (in 10^7cm^{-1})

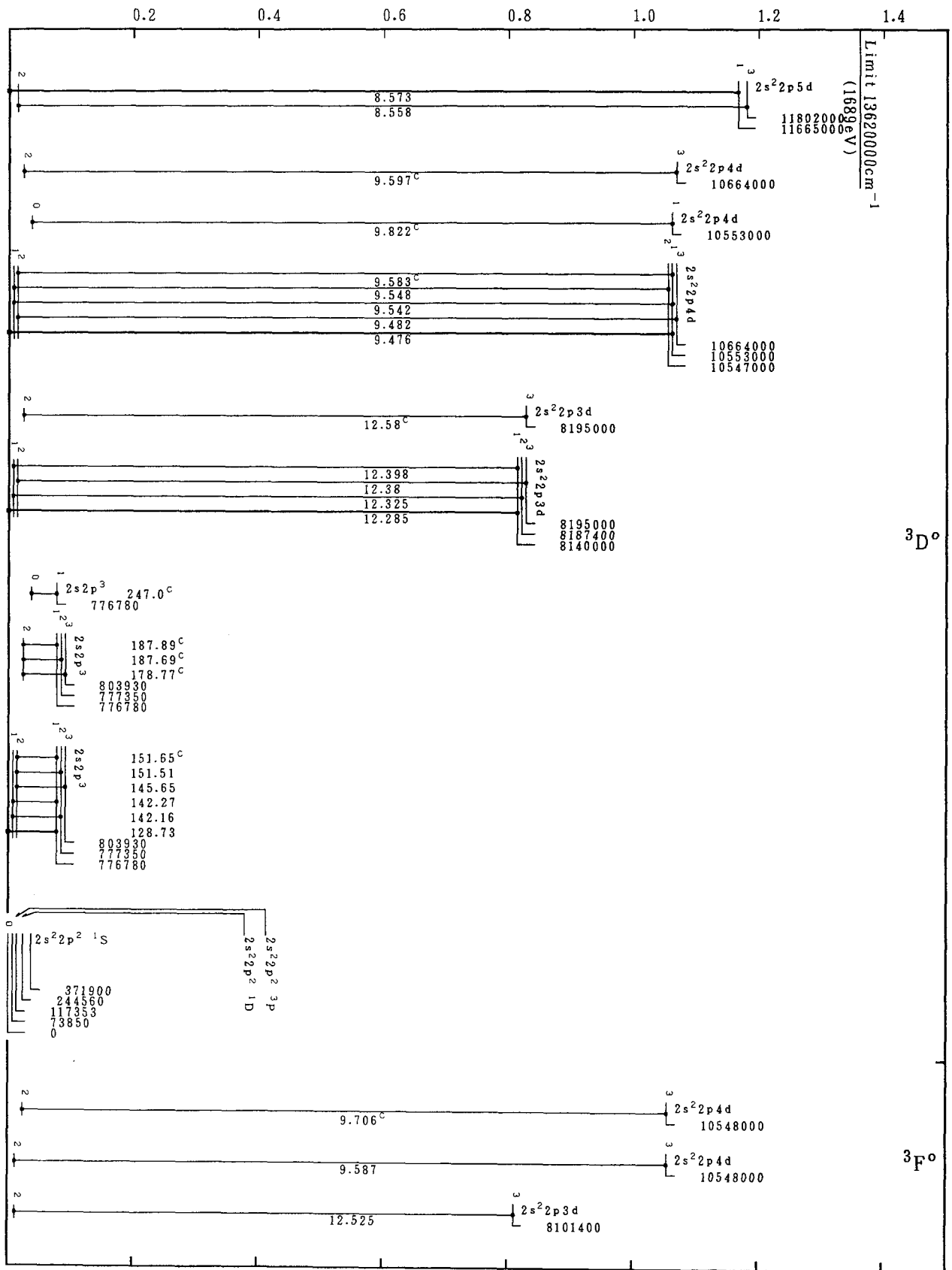

Grotrian Diagrams for Fe XXI (C-Sequence)-Continued

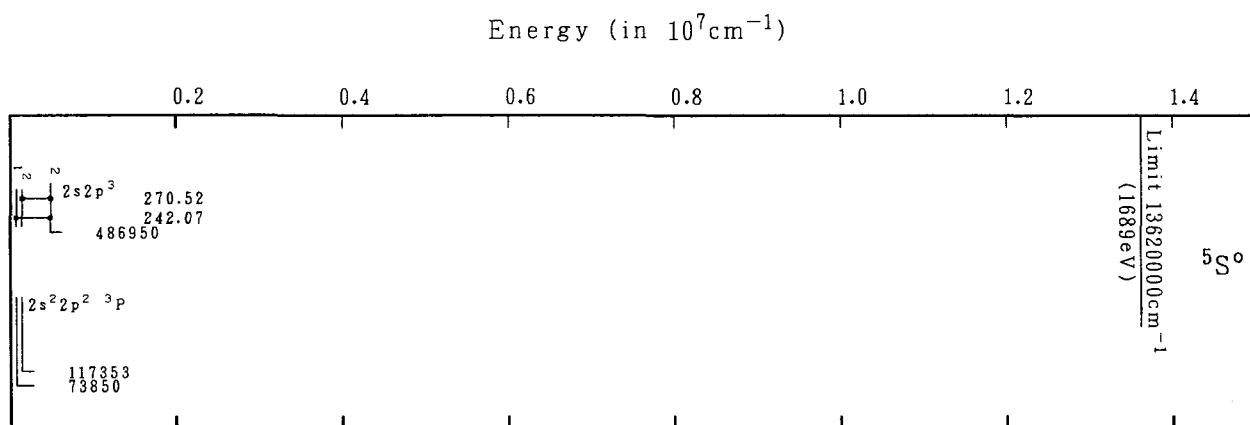

Grotrian Diagrams for Fe XXI (C-Sequence)-Continued

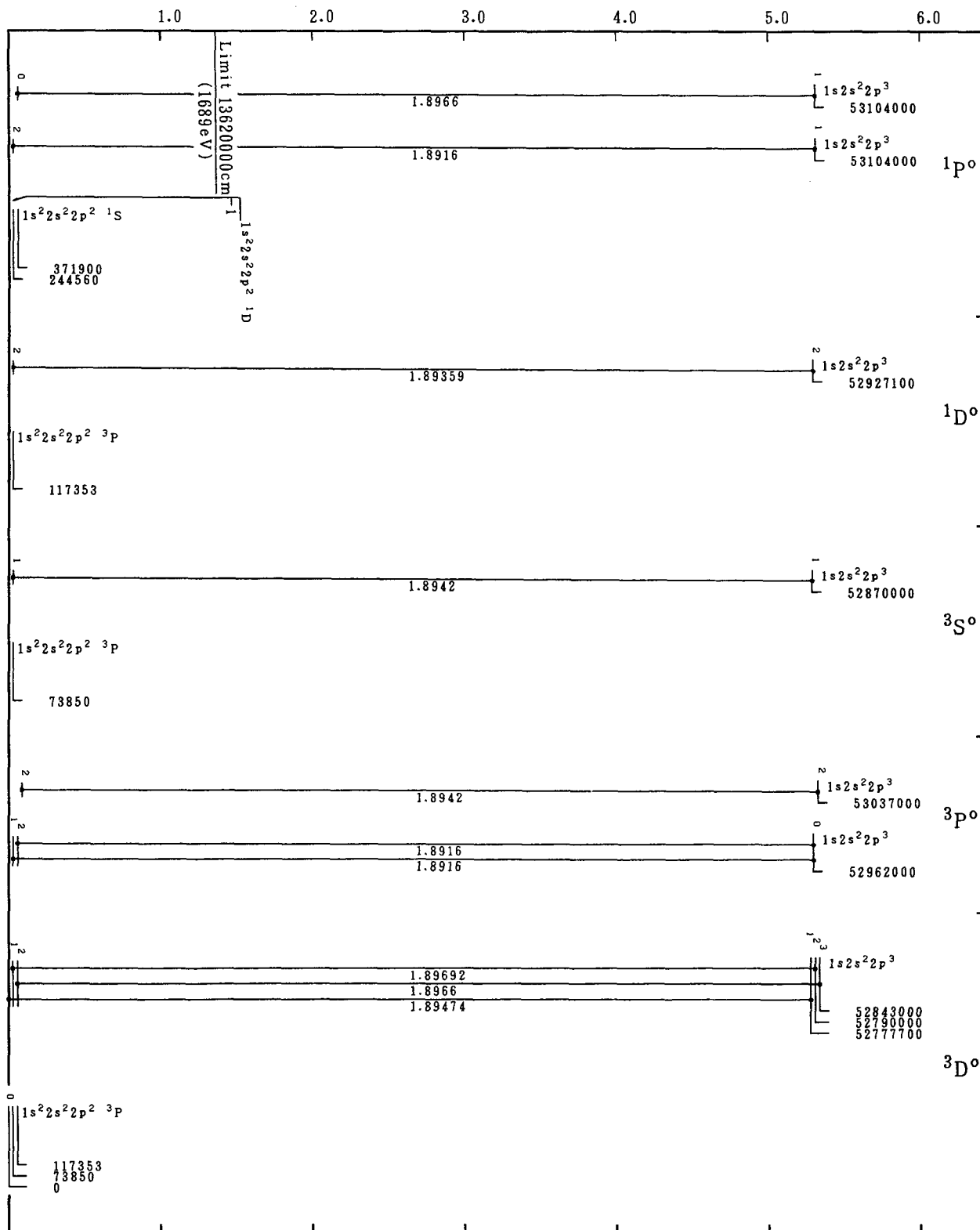
Energy (in 10^7cm^{-1})

Grotrian Diagrams for Fe XXI (C-Sequence)-Continued

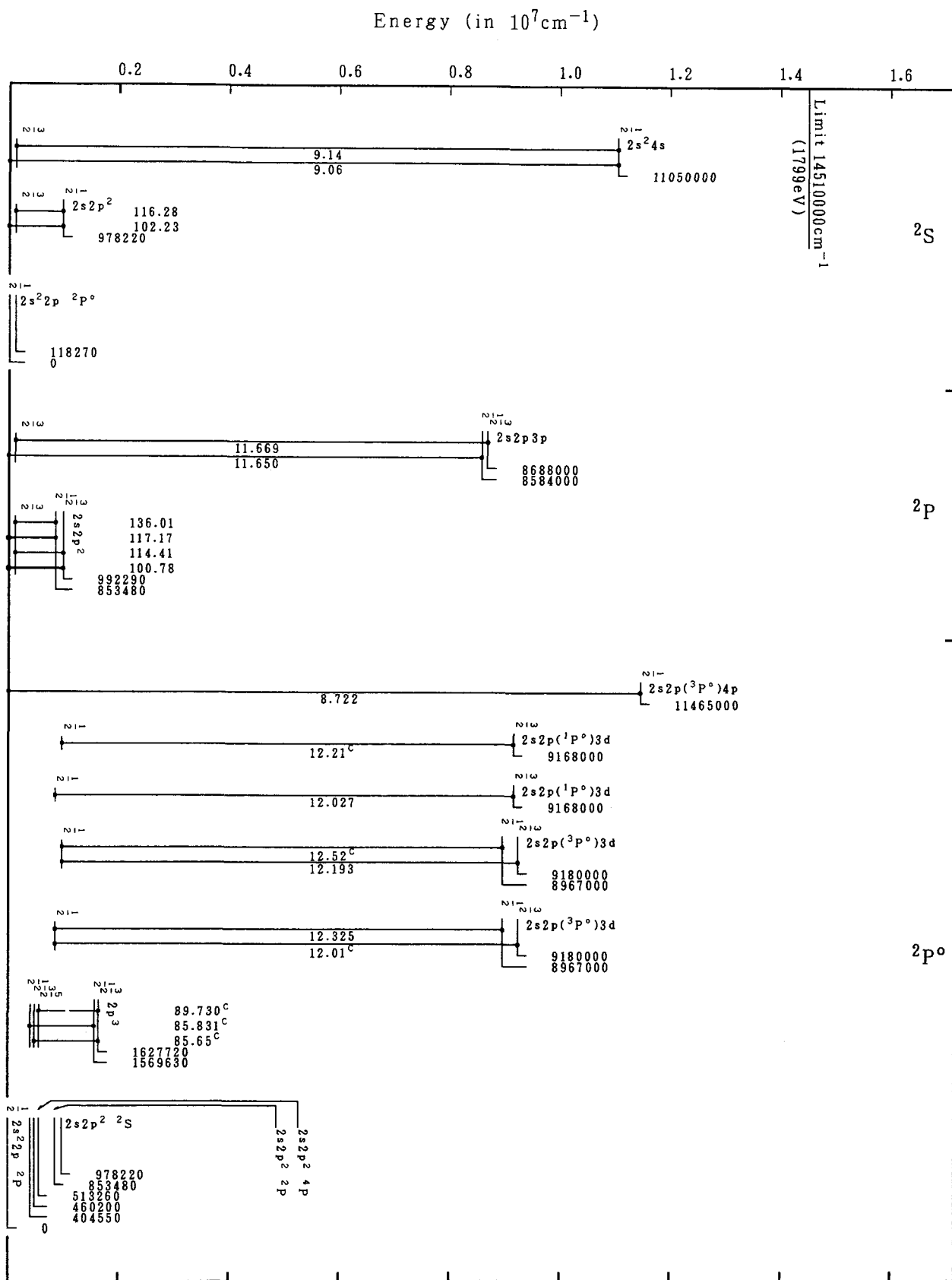

Grotrian Diagrams for Fe XXII (B-Sequence)

Energy (in 10^7cm^{-1})

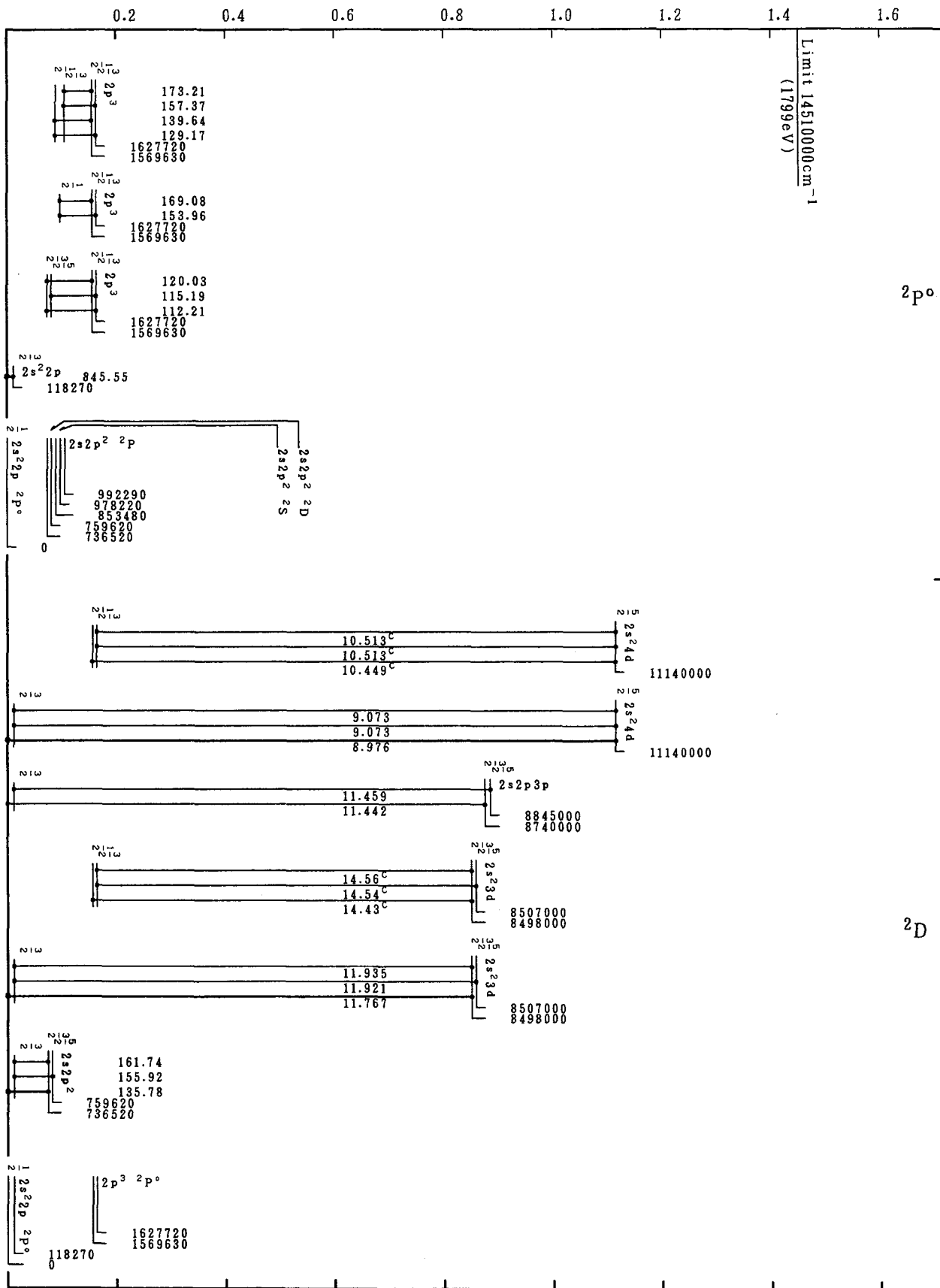

Grotrian Diagrams for Fe XXII (B-Sequence)-Continued

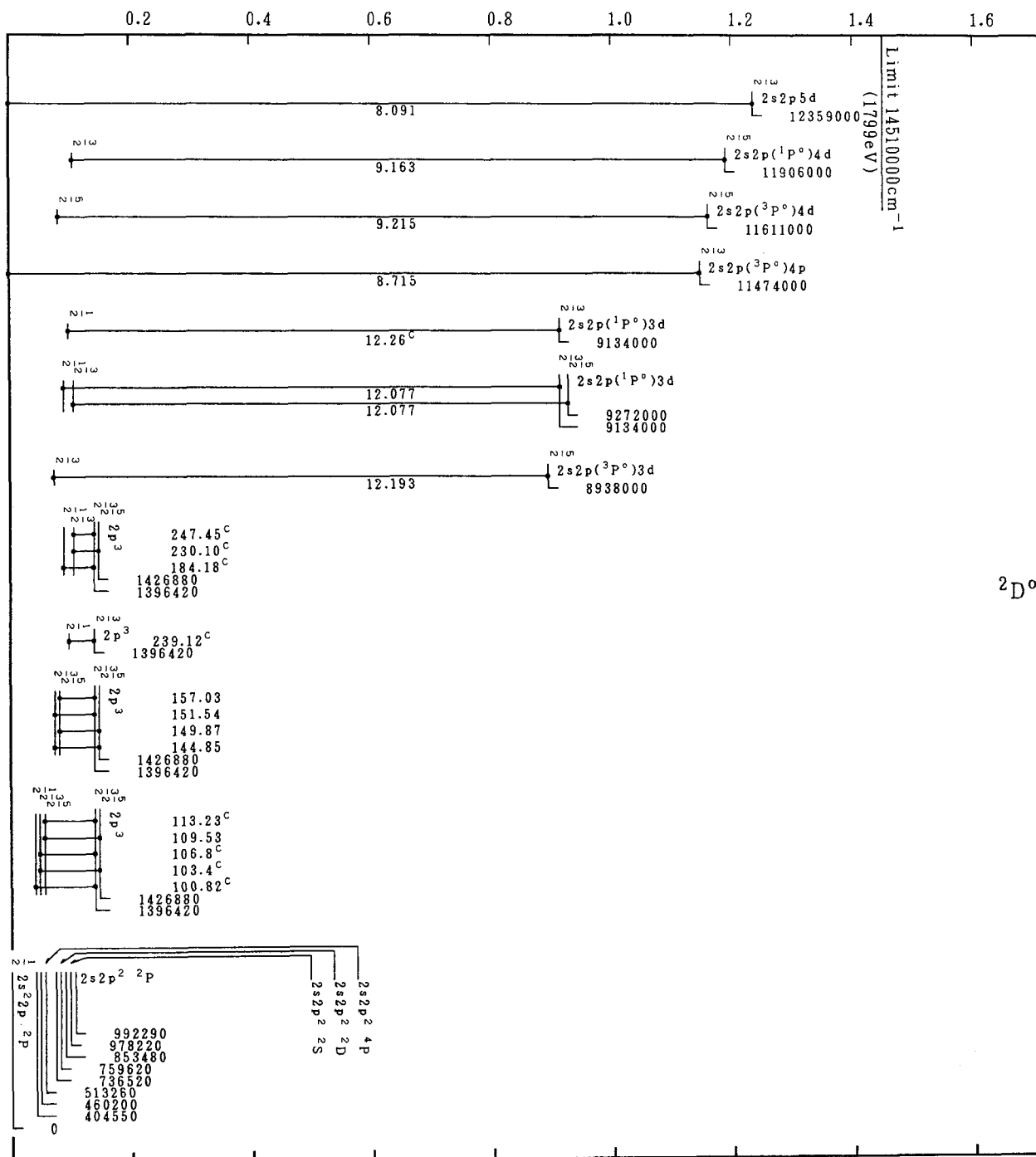
Energy (in 10^7cm^{-1})

Grotrian Diagrams for Fe XXII (B-Sequence)-Continued

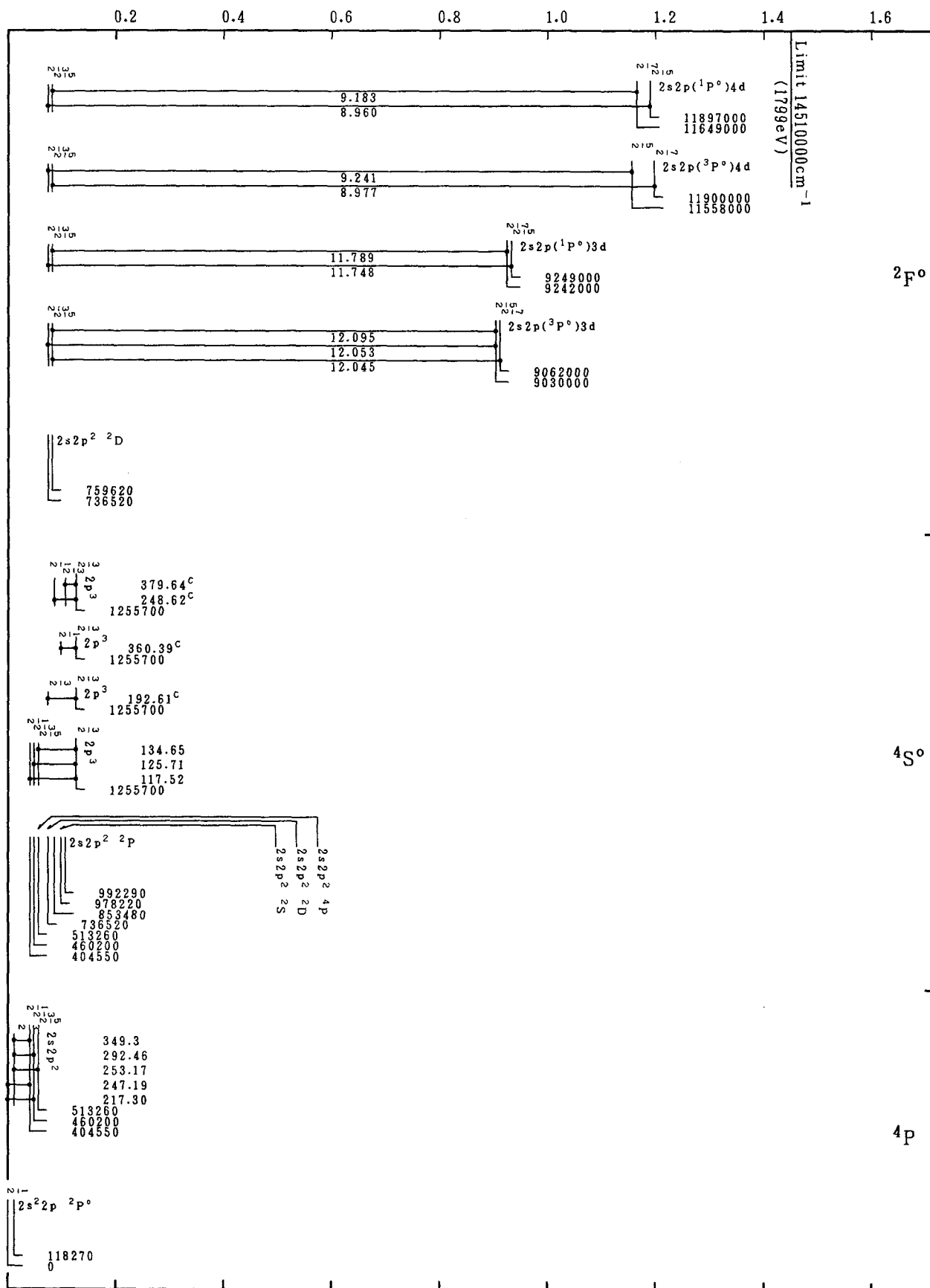
Energy (in 10^7cm^{-1})

Grotrian Diagrams for Fe XXII (B-Sequence)-Continued

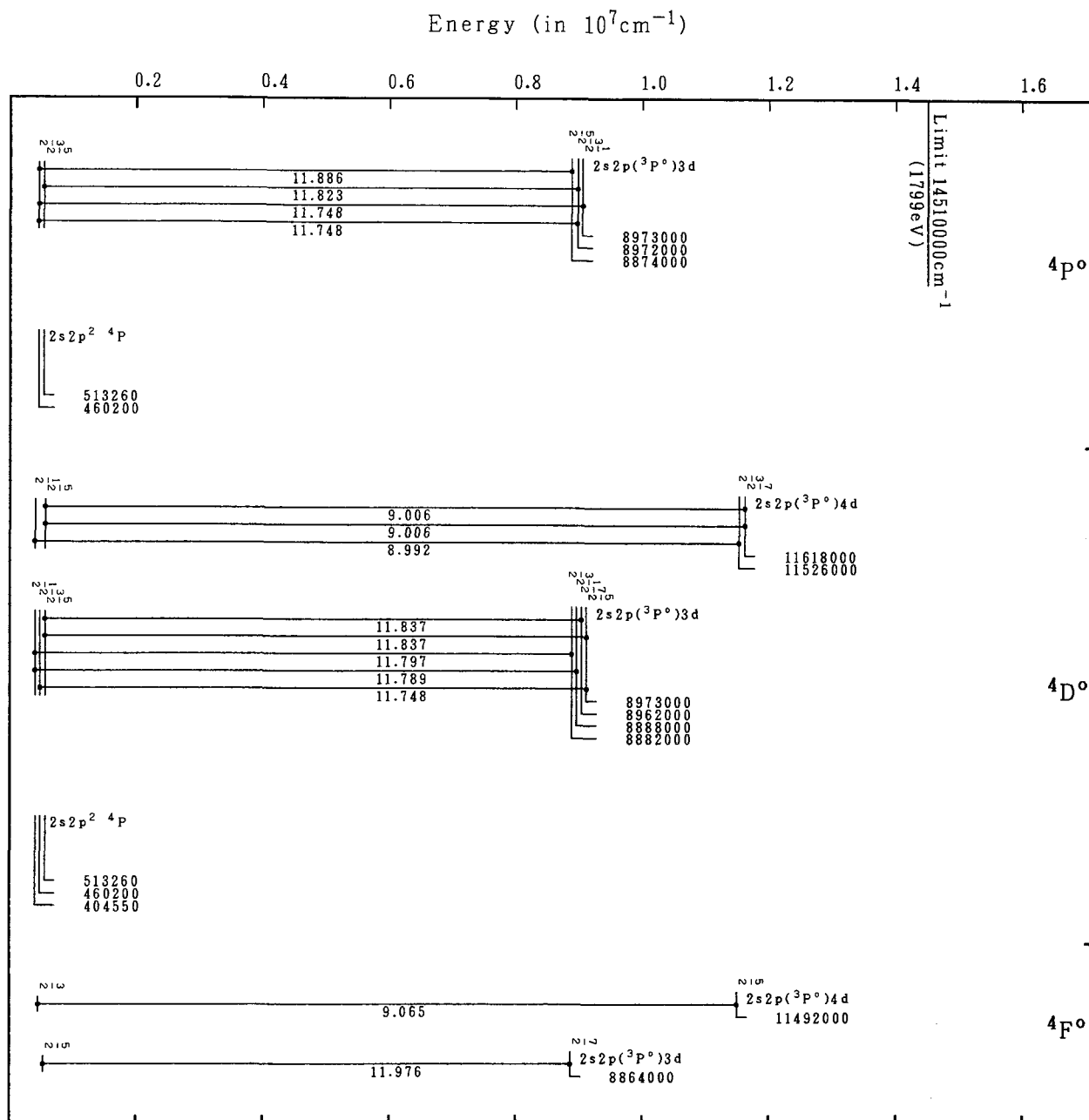

Grotrian Diagrams for Fe XXII (B-Sequence)-Continued

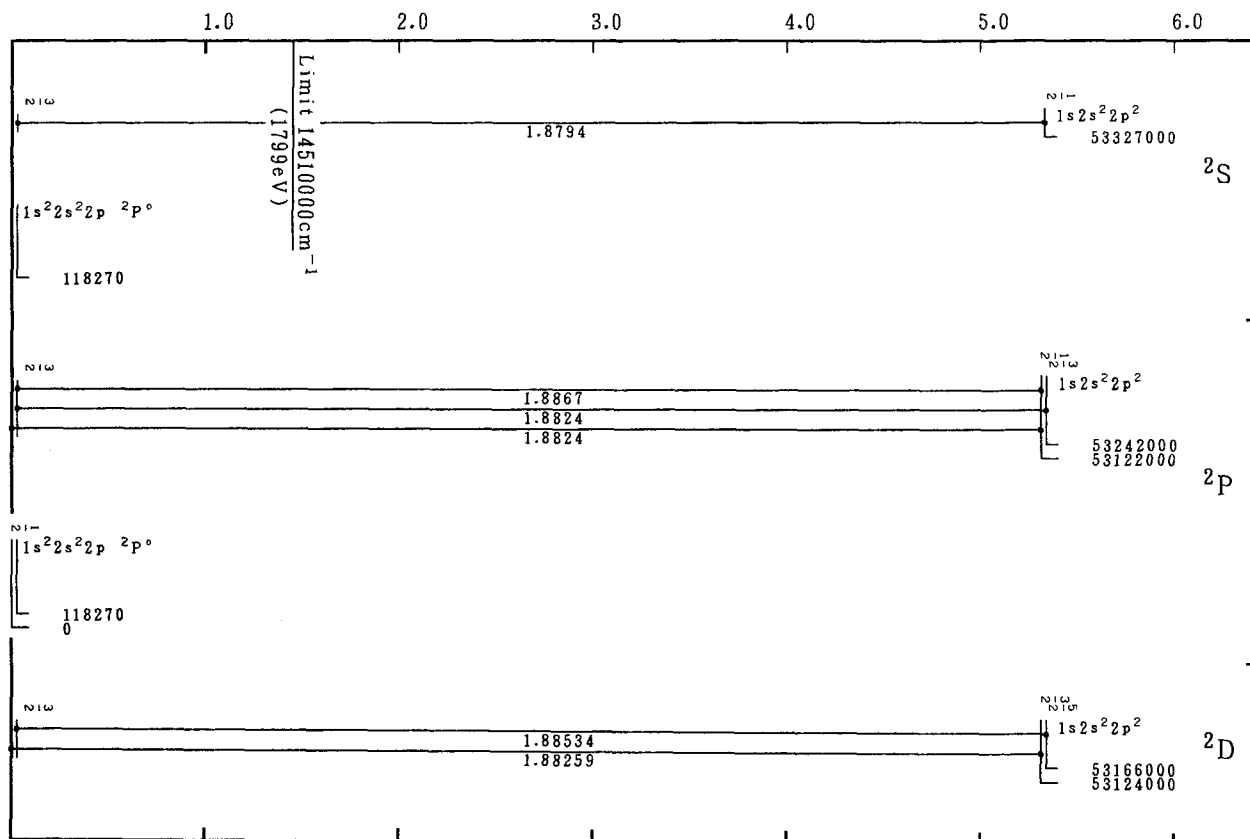
Energy (in 10^7cm^{-1})

Grotrian Diagrams for Fe XXII (B-Sequence)-Continued

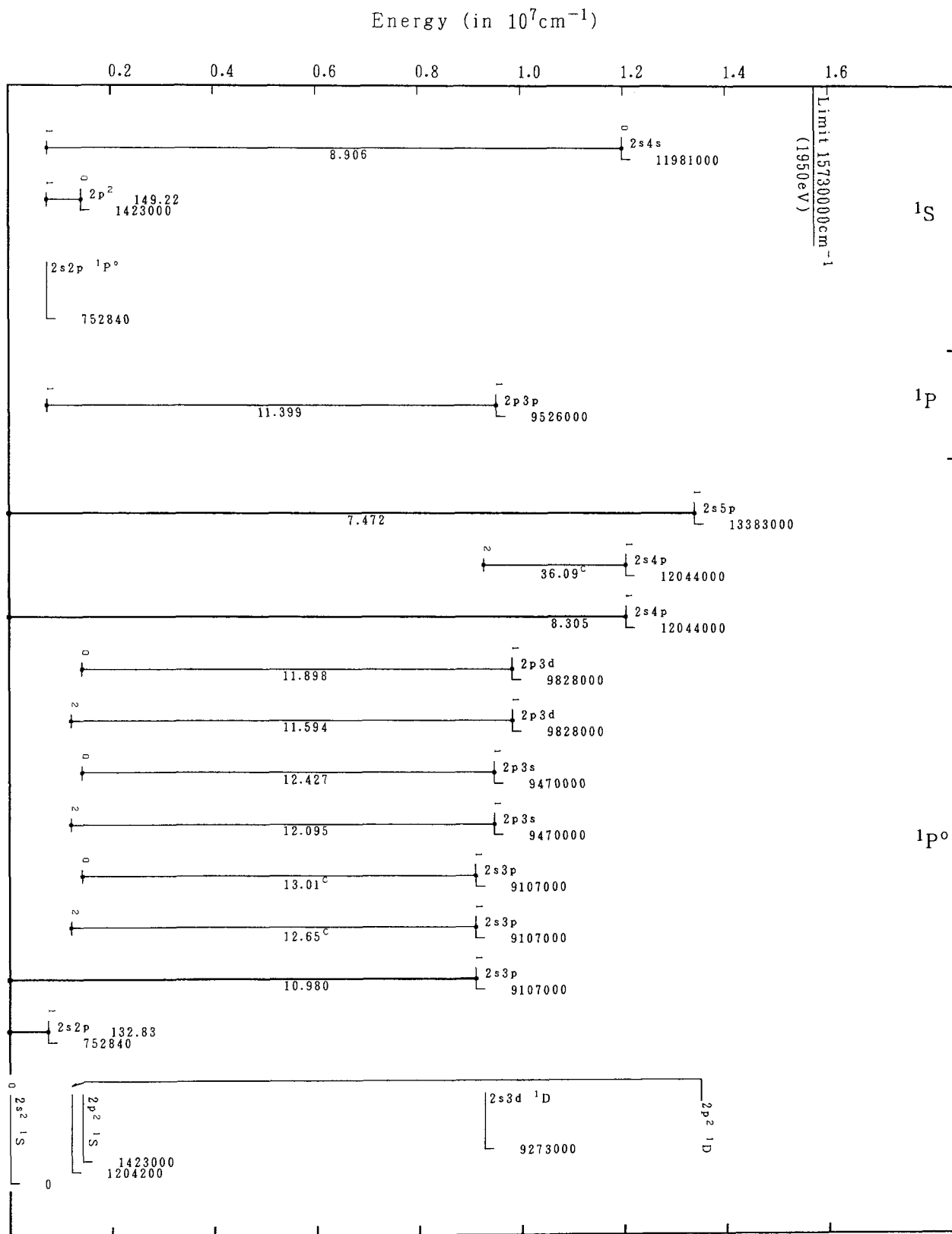

Grotrian Diagrams for Fe XXIII (Be-Sequence)

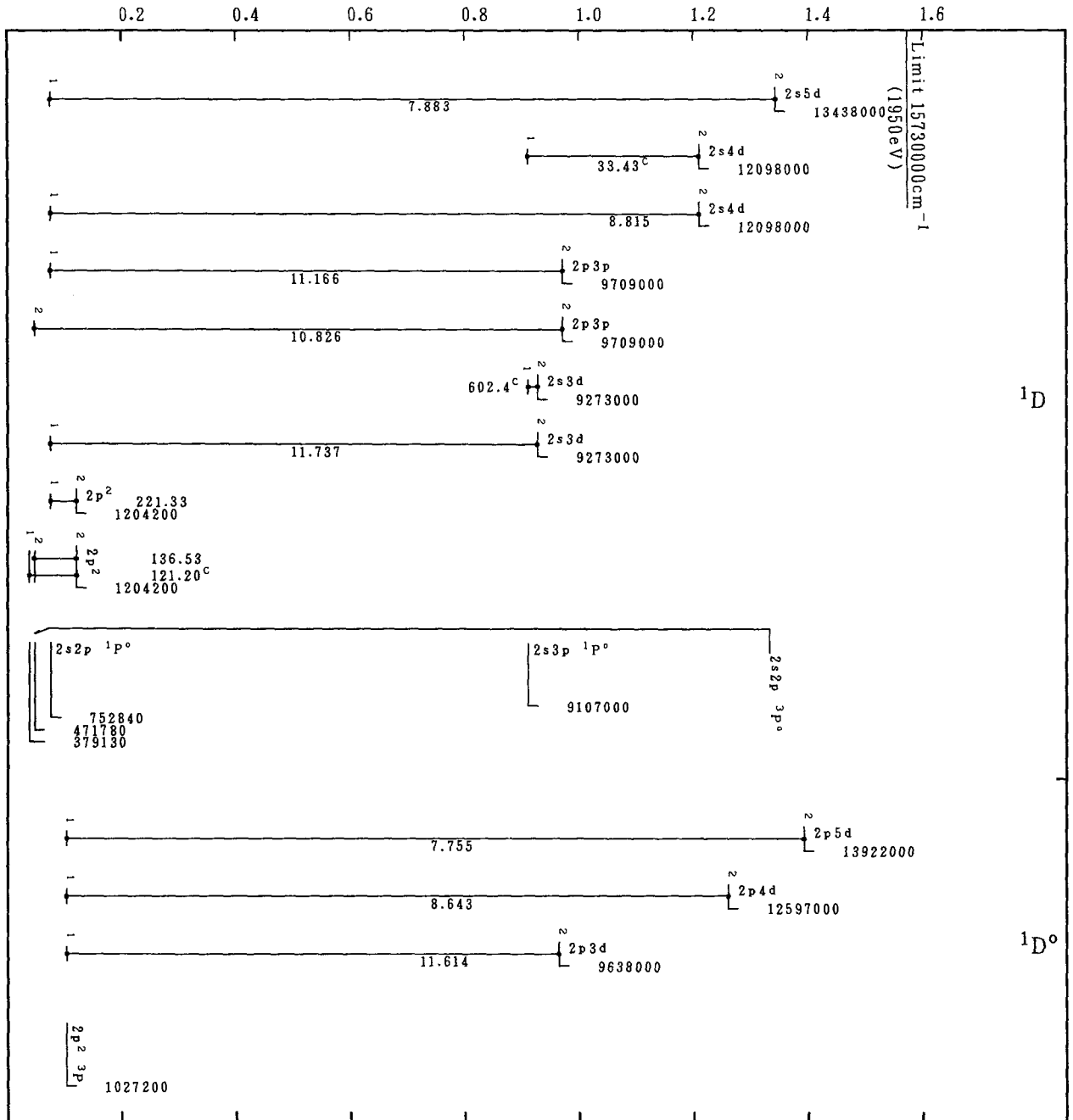
Energy (in 10^7cm^{-1})

Grotrian Diagrams for Fe XXIII (Be-Sequence)-Continued

Energy (in 10^7cm^{-1})

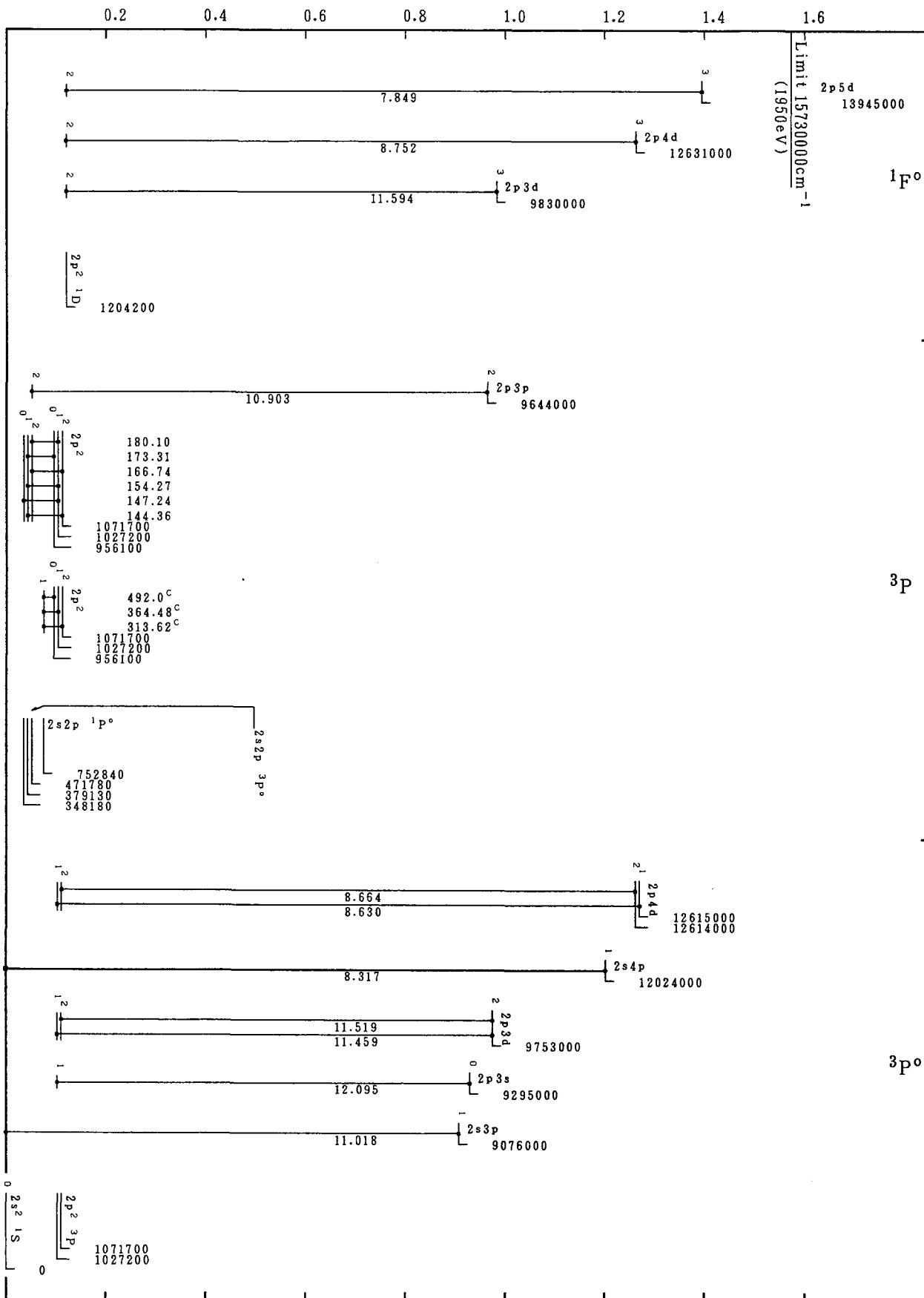

Grotrian Diagrams for Fe XXIII (Be-Sequence)-Continued

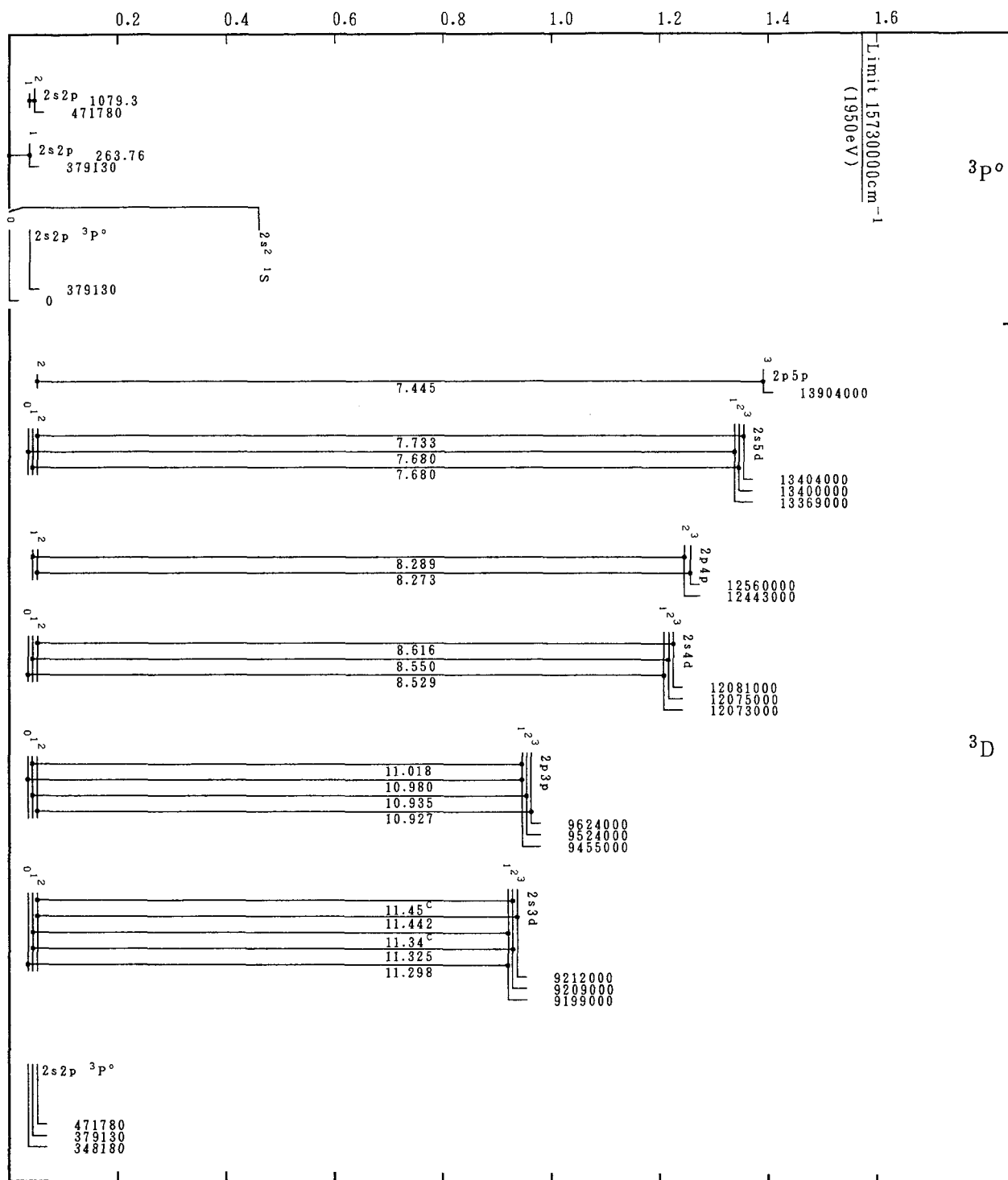
Energy (in 10^7cm^{-1})

Grotrian Diagrams for Fe XXIII (Be-Sequence)-Continued

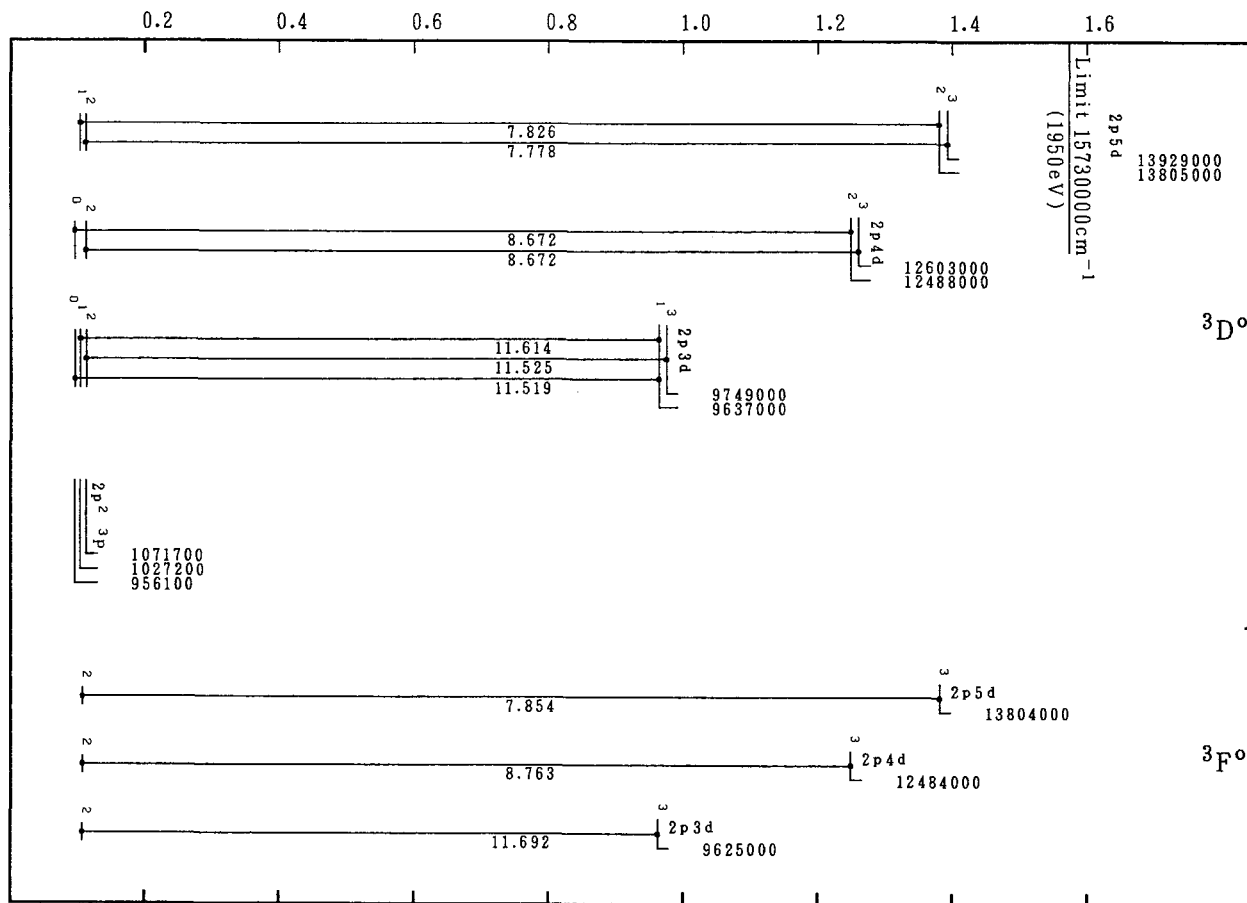
Energy (in 10^7cm^{-1})

Grotrian Diagrams for Fe XXIII (Be-Sequence)-Continued

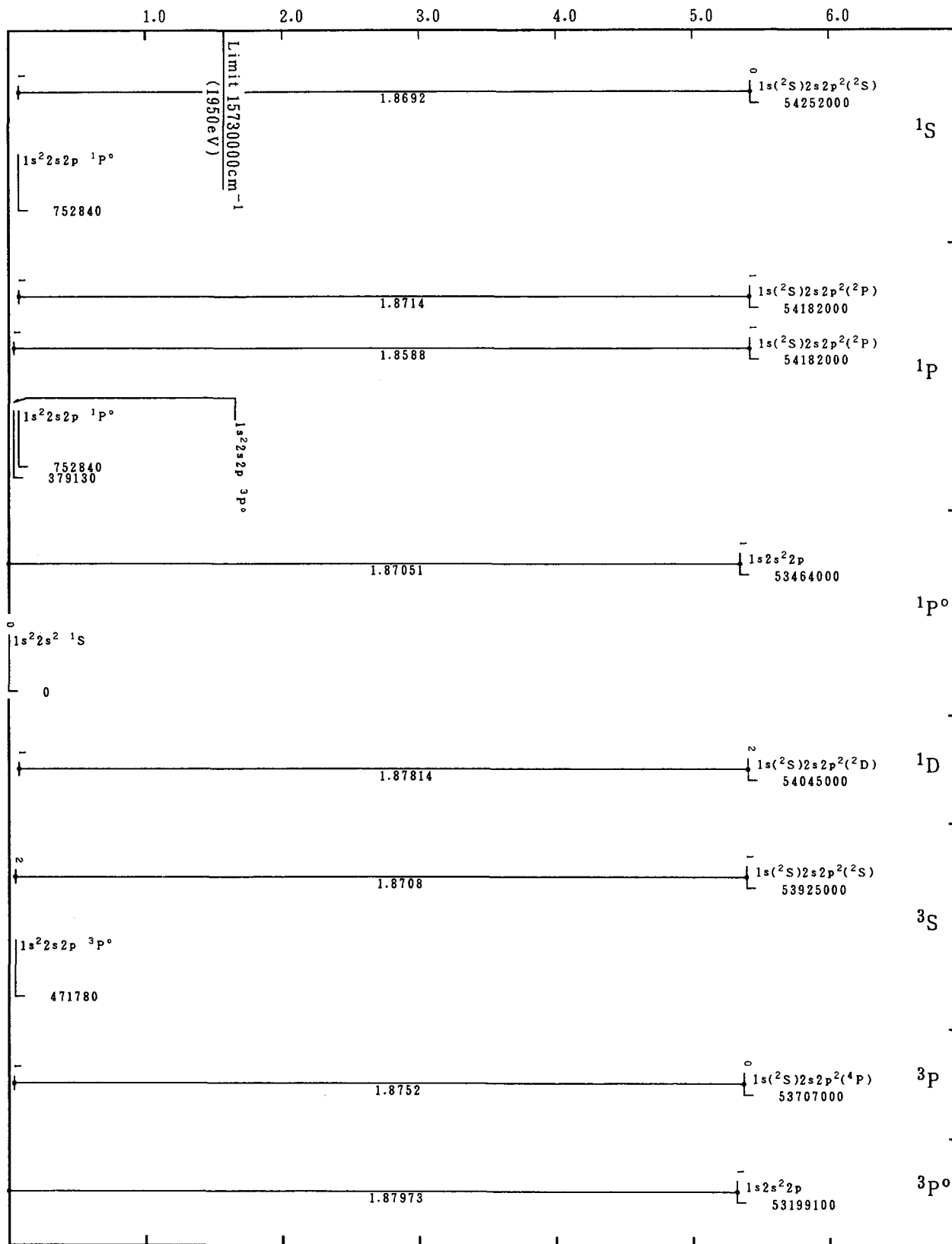
Energy (in 10^7cm^{-1})

Grotrian Diagrams for Fe XXIII (Be-Sequence)-Continued

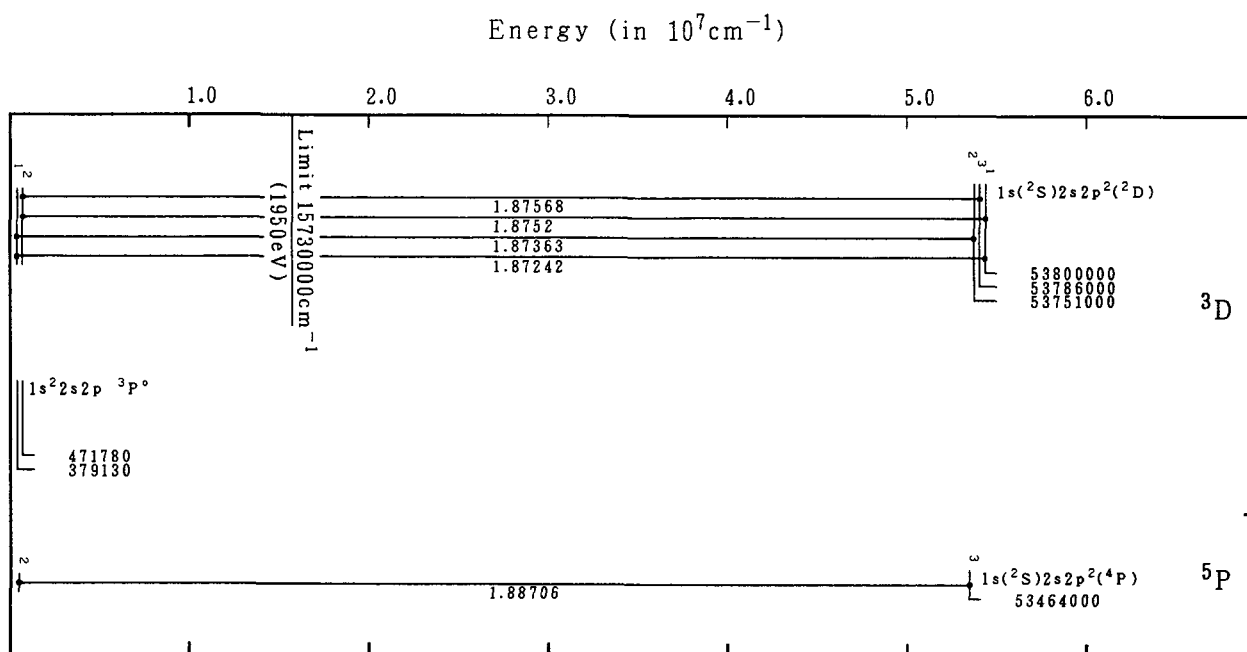

Grotrian Diagrams for Fe XXIII (Be-Sequence)-Continued

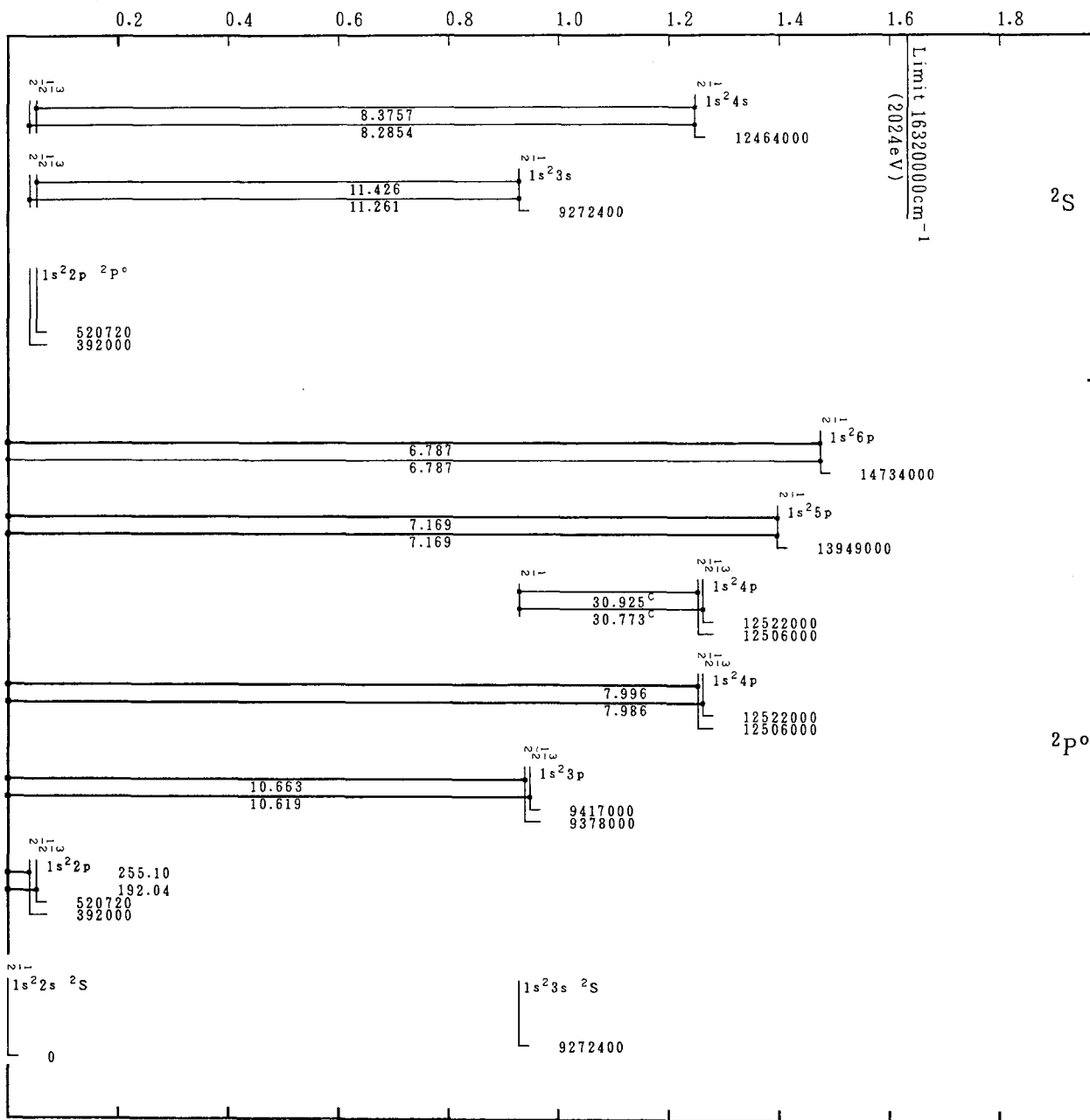
Energy (in 10^7cm^{-1})

Grotrian Diagrams for Fe XXIV (Li-Sequence)

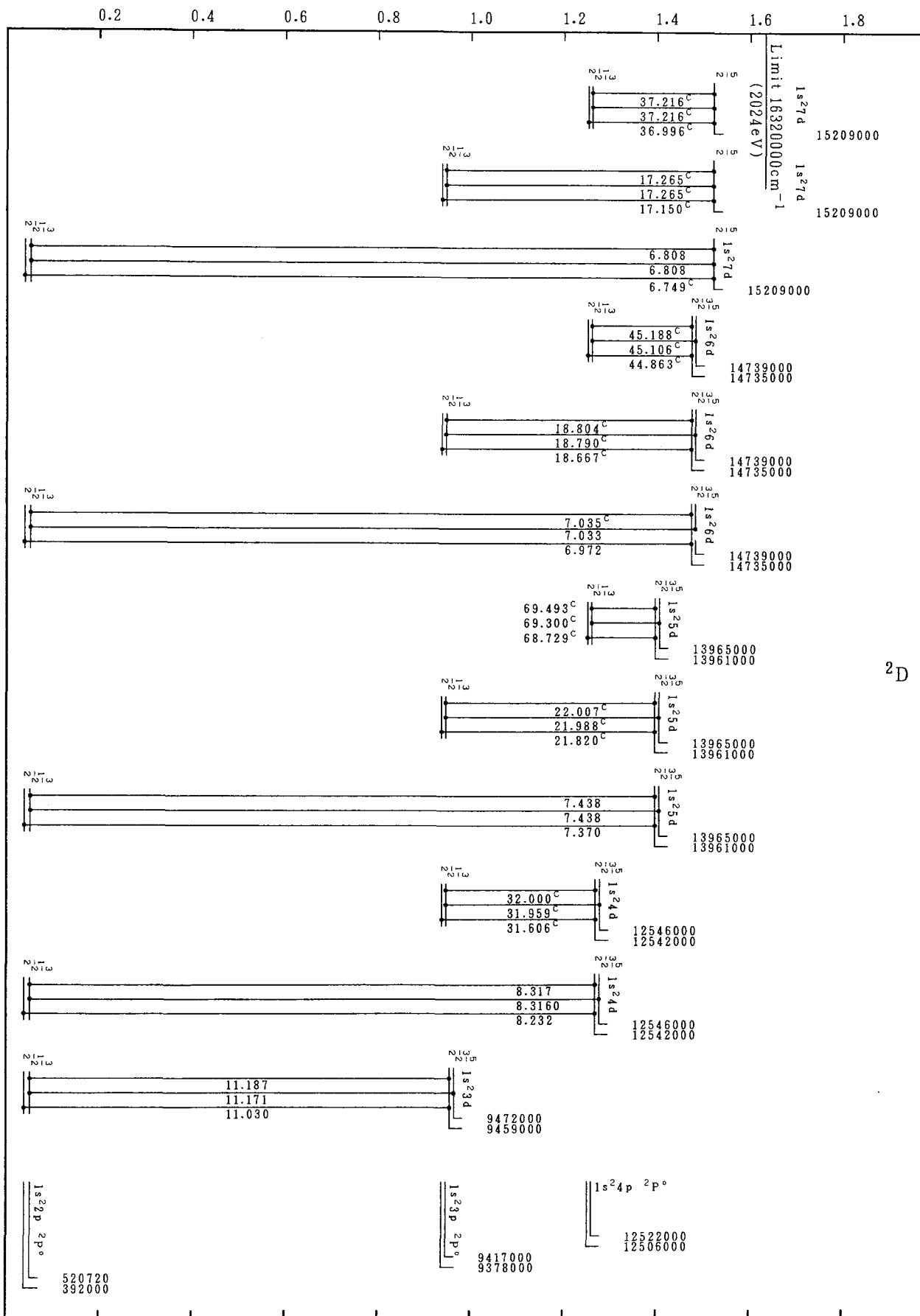
Energy (in 10^7cm^{-1})

Grotrian Diagrams for Fe XXIV (Li-Sequence)-Continued

Energy (in 10^7cm^{-1})

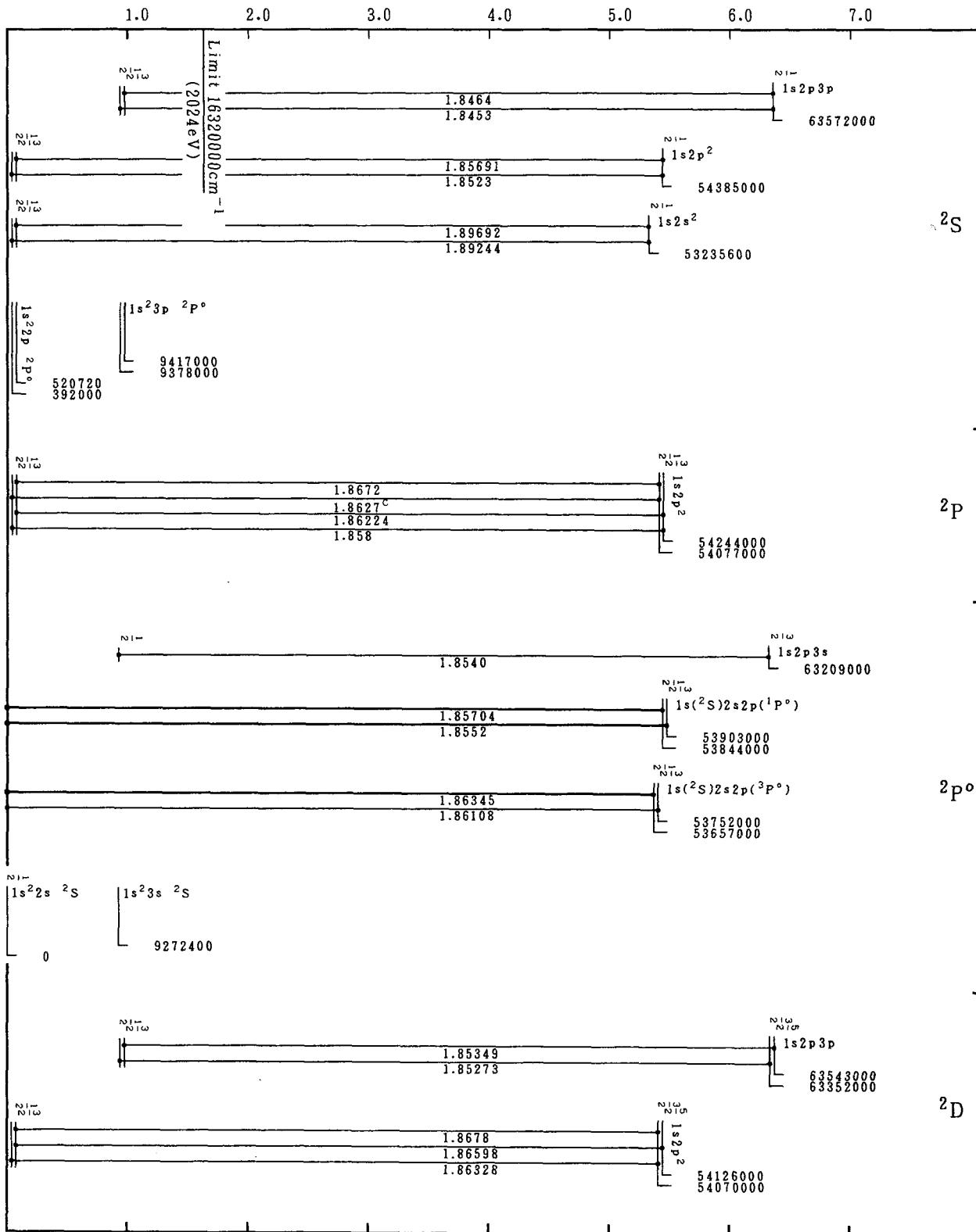

Grotrian Diagrams for Fe XXIV (Li-Sequence)-Continued

Energy (in 10^7cm^{-1})

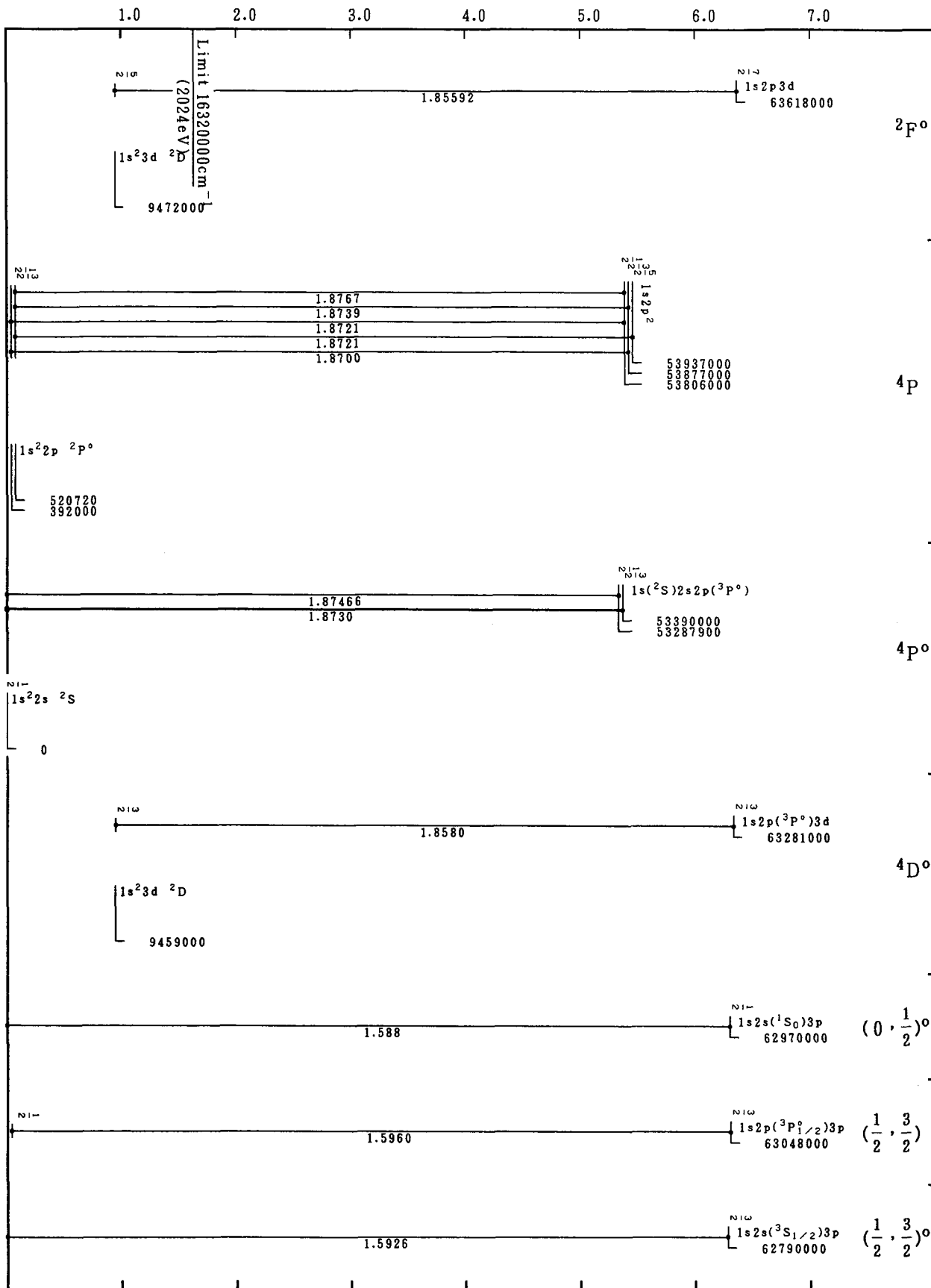

Grotrian Diagrams for Fe XXIV (Li-Sequence)

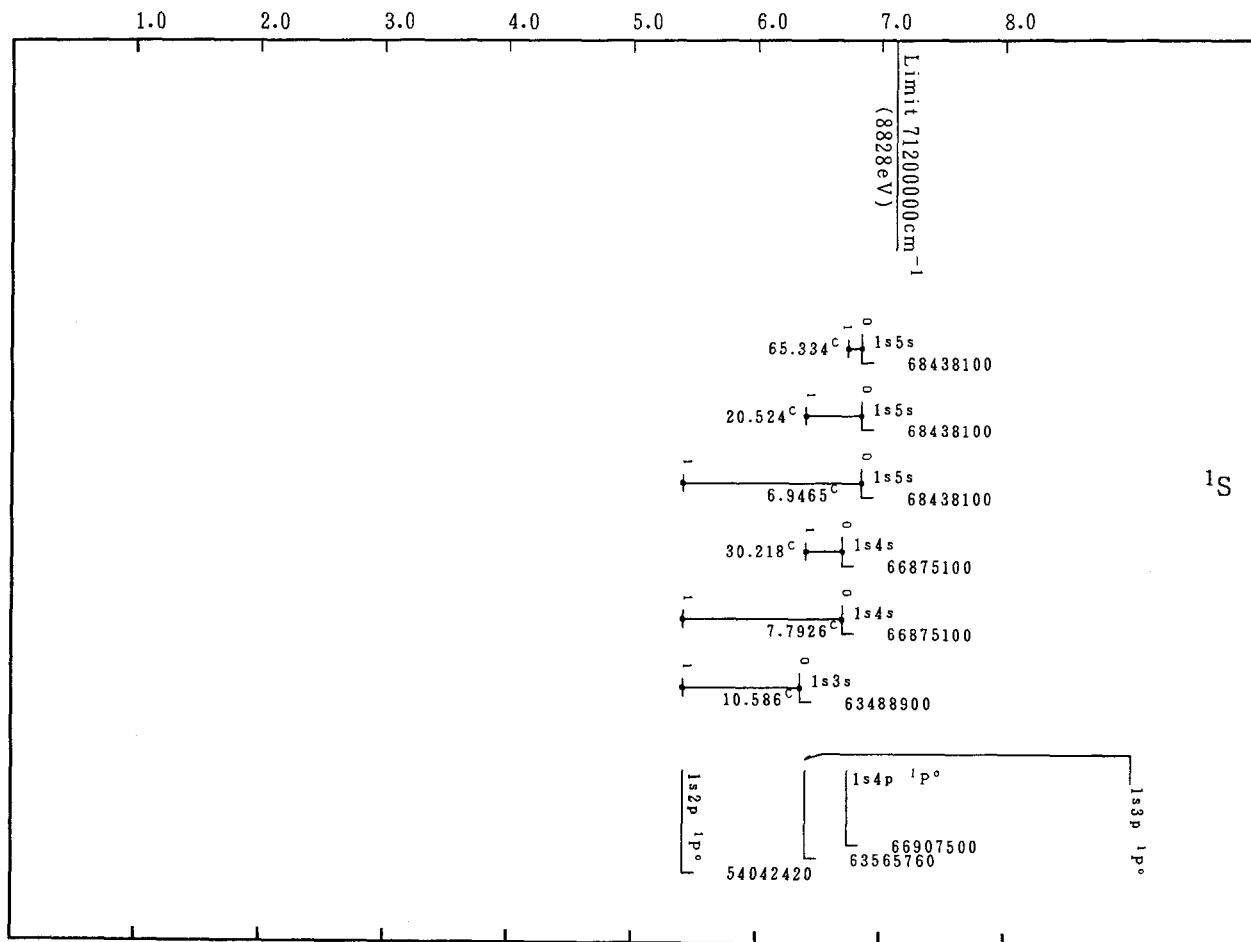
Energy (in 10^7cm^{-1})

Grotrian Diagrams for Fe XXV (He-Sequence)

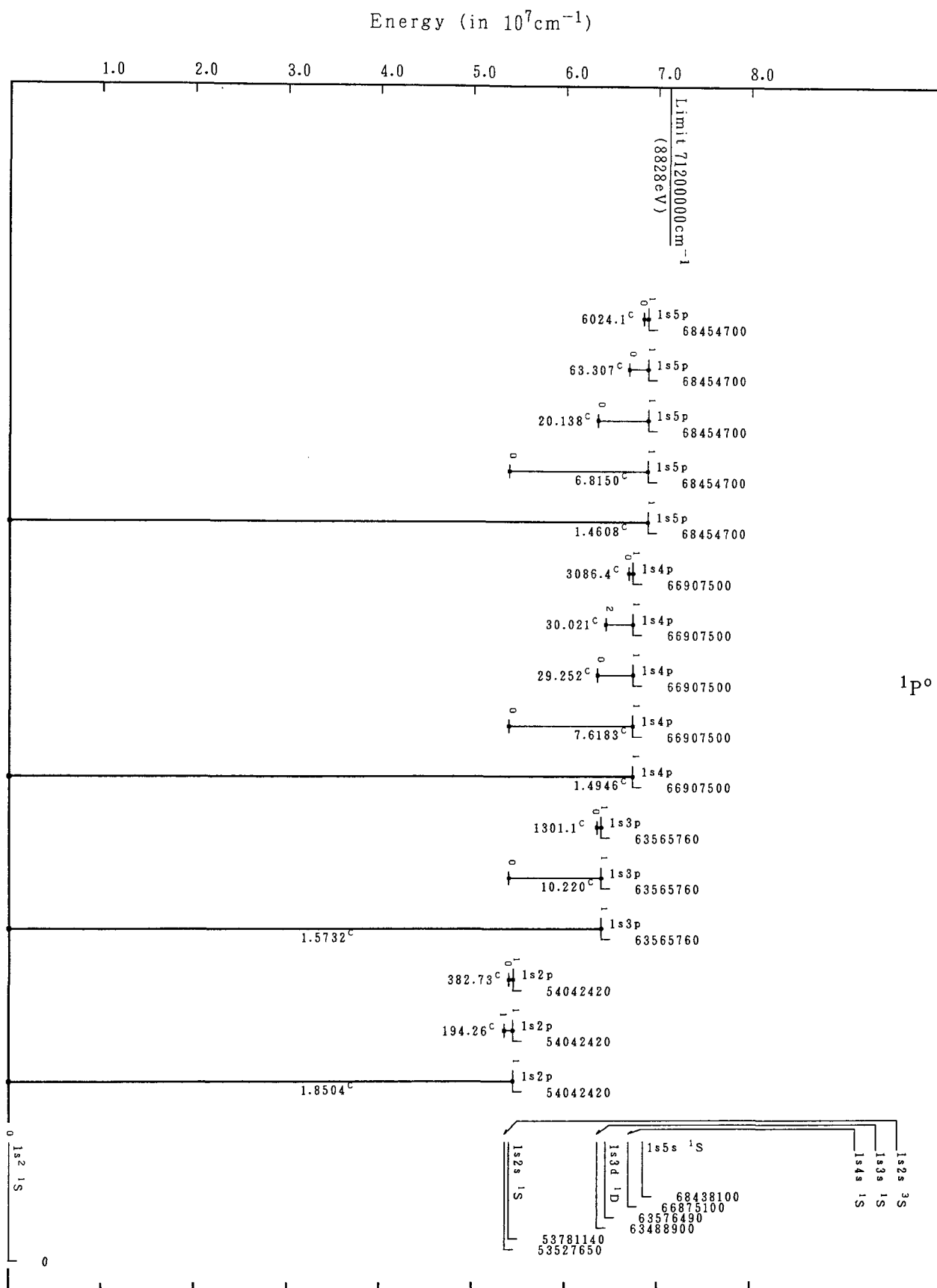

Grotrian Diagrams for Fe XXV (He-Sequence)-Continued

Energy (in 10^7cm^{-1})

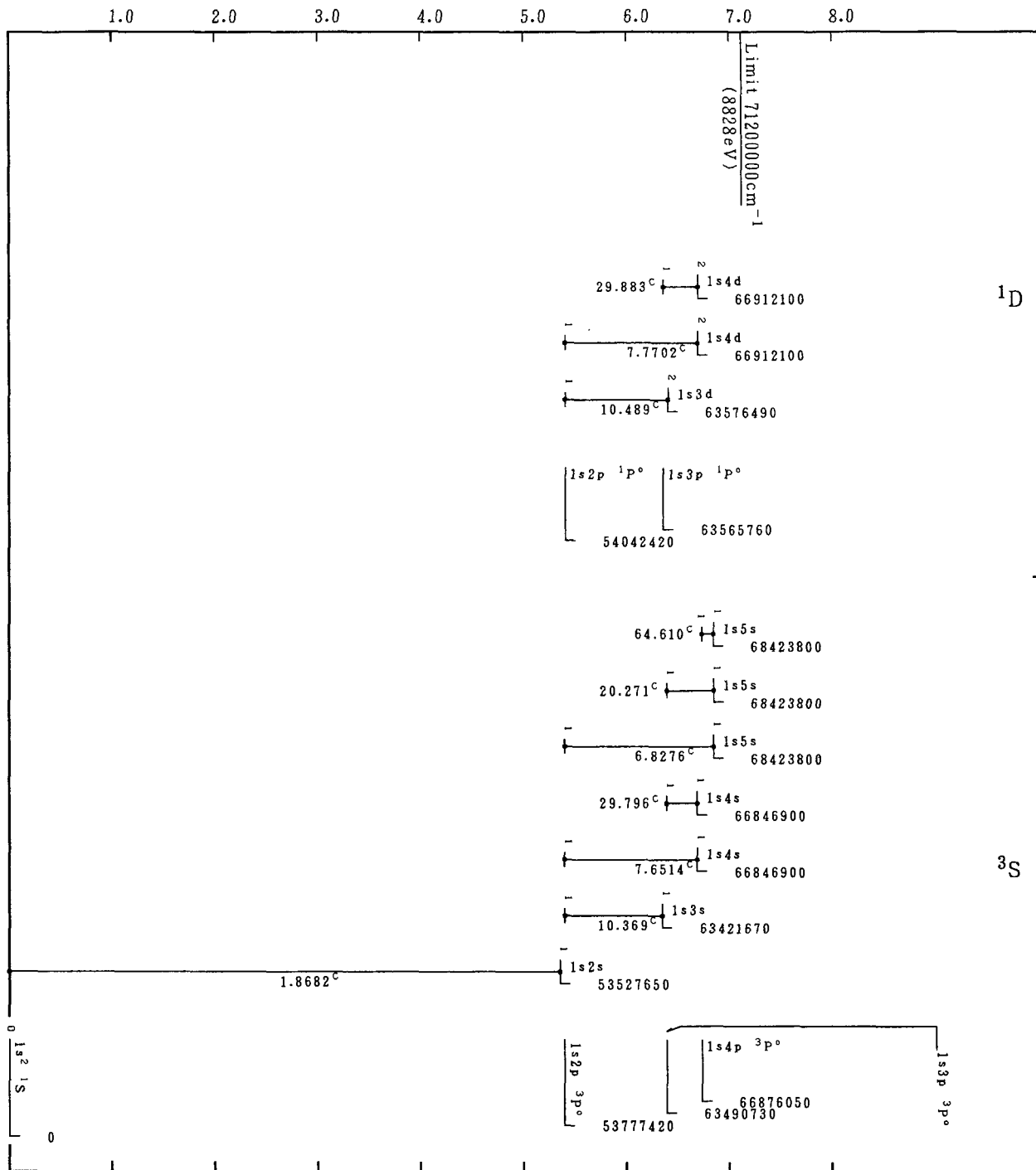

Grotrian Diagrams for Fe XXV (He-Sequence)-Continued

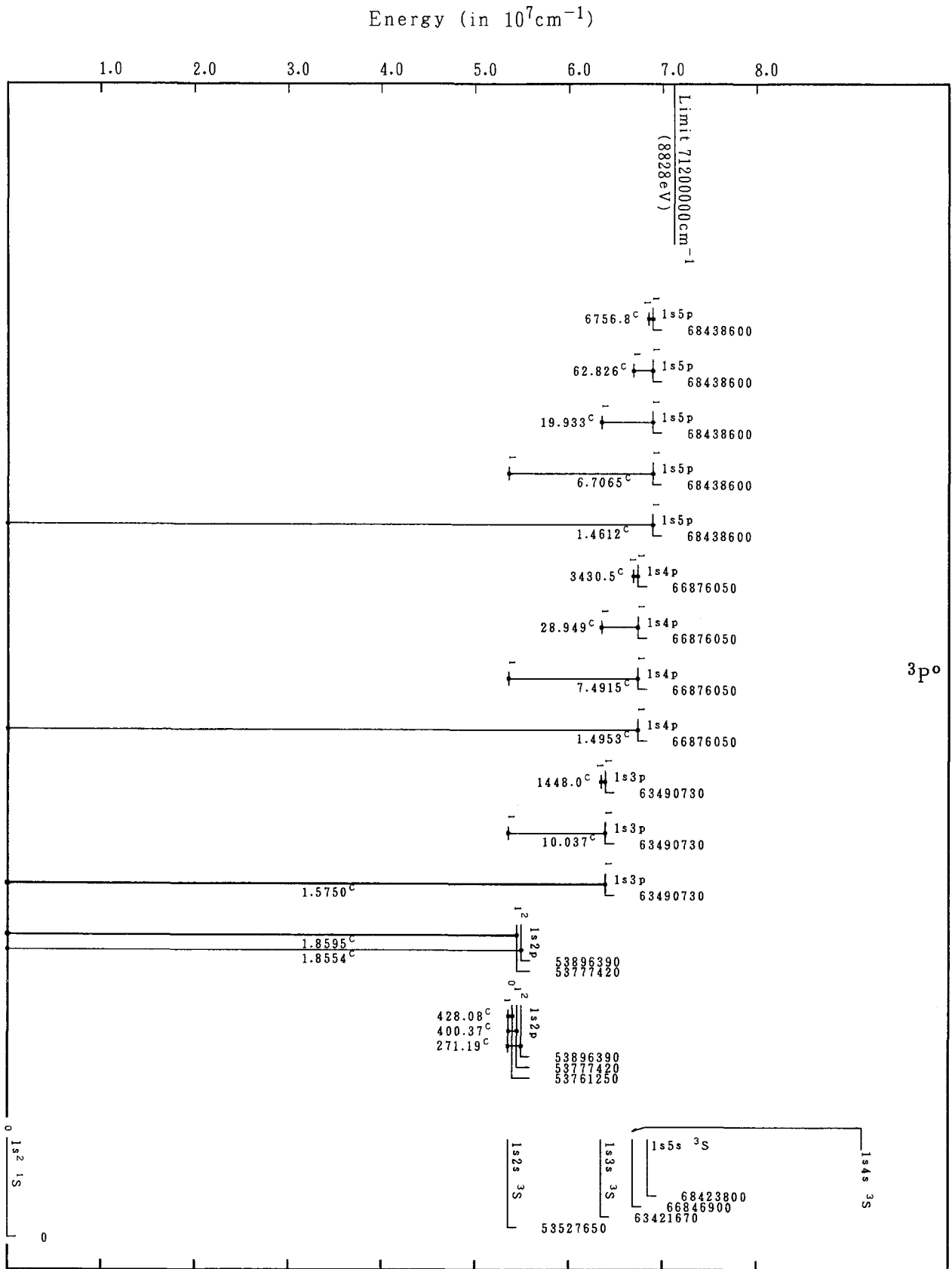

Grotrian Diagrams for Fe XXV (He-Sequence)-Continued

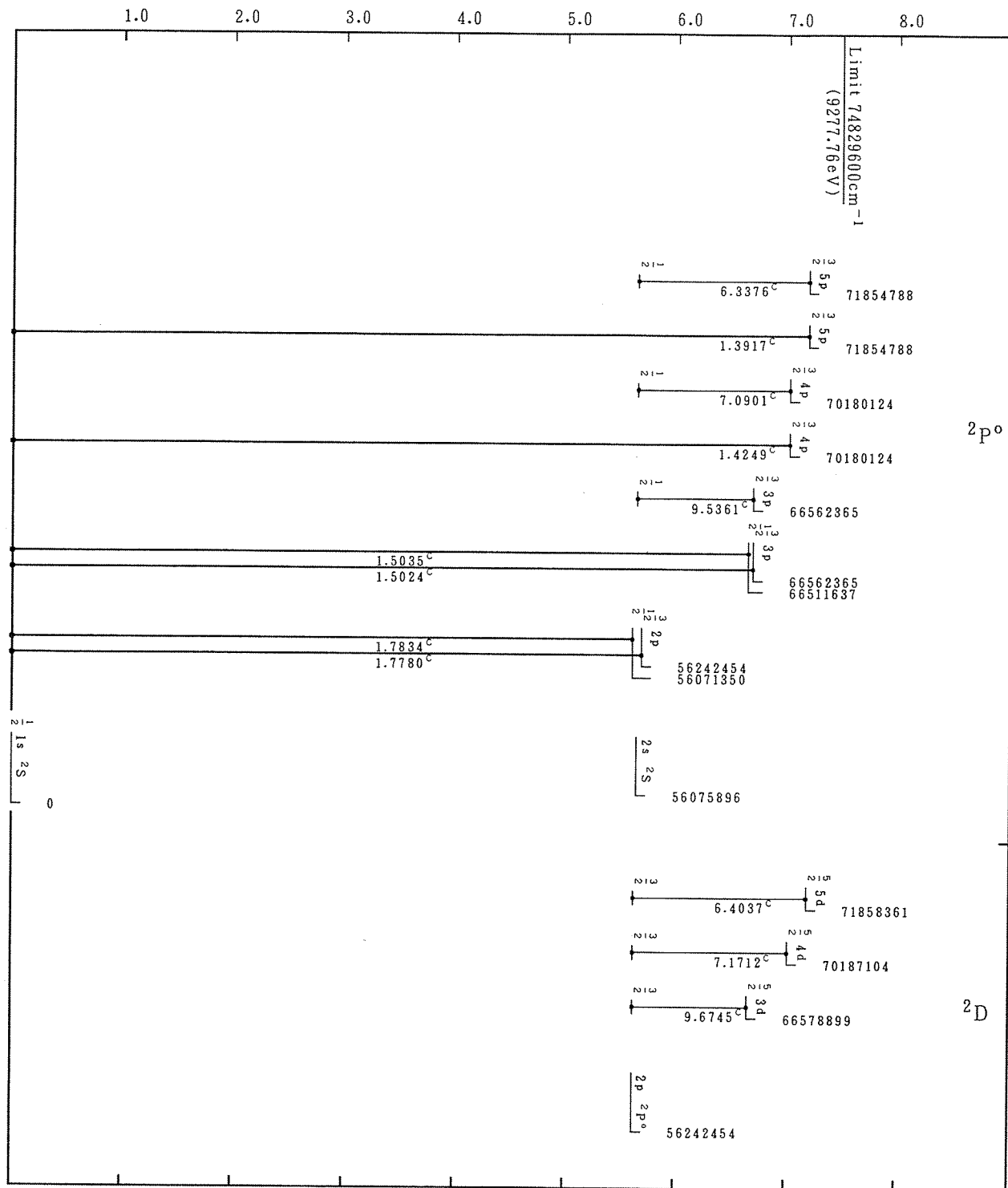
Energy (in 10^7cm^{-1})

Grotrian Diagrams for Fe XXVI (H-Sequence)

7. References for Comments and Tables

- ¹N. Acquista and J. Reader, *J. Opt. Soc. Am. B* **1**, 649 (1984).
- ²E. Alexander, U. Feldman, and B. S. Fraenkel, *J. Opt. Soc. Am.* **55**, 650 (1965).
- ³W. E. Behring, L. Cohen, and U. Feldman, *Astrophys. J.* **175**, 493 (1972).
- ⁴W. E. Behring, L. Cohen, U. Feldman, and G. A. Doschek, *Astrophys. J.* **203**, 521 (1976).
- ⁵P. Beiersdorfer, M. Bitter, S. von Goeler, S. Cohen, K. W. Hill, J. Timberlake, R. S. Walling, M. H. Chen, P. L. Hagelstein, and J. H. Scofield, *Phys. Rev.* **34**, 1297 (1986).
- ⁶A. K. Bhatia and S. O. Kastner, *J. Quant. Spectrosc. Radiat. Transfer* **24**, 53 (1980).
- ⁷A. K. Bhatia, U. Feldman, and J. F. Seely, *Atom. Data Nucl. Data Tables* **35**, 319 (1986).
- ⁸A. K. Bhatia, J. F. Seely, and U. Feldman, *Atom. Data Nucl. Data Tables* **36**, 453 (1987).
- ⁹E. Biémont and G. E. Bromage, *Mon. Not. R. Astr. Soc.* **205**, 1085 (1983).
- ¹⁰E. Biémont and J. E. Hansen, *Phys. Scr.* **31**, 509 (1985).
- ¹¹E. Biémont, *Phys. Scr.* **33**, 324 (1986).
- ¹²M. Bitter, K. W. Hill, N. Sauthoff, P. C. Efthimion, E. Meservey, W. Roney, S. von Goeler, R. Horton, M. Goldman, and W. Stodiek, *Phys. Rev. Lett.* **43**, 129 (1979).
- ¹³M. Bitter, S. von Goeler, K. W. Hill, R. Horton, D. Johnson, W. Roney, N. Sauthoff, E. Silver, and W. Stodiek, *Phys. Rev. Lett.* **47**, 921 (1981).
- ¹⁴V. A. Boiko, Yu. P. Voinov, V. A. Gribkov, and G. V. Sklizkov, *Opt. Spectrosc.* **29**, 545 (1970).
- ¹⁵V. A. Boiko, S. A. Pikuz, U. I. Safronova, and A. Ya. Faenov, *J. Phys. B* **10**, 1253 (1977).
- ¹⁶V. A. Boiko, A. Ya. Faenov, and S. A. Pikuz, *J. Quant. Spectrosc. Radiat. Transfer* **19**, 11 (1978).
- ¹⁷V. A. Boiko, S. A. Pikuz, A. S. Safronova, and A. Ya. Faenov, *Opt. Spectrosc.* **44**, 498 (1978).
- ¹⁸V. A. Boiko, S. A. Pikuz, A. S. Safronova, A. Ya. Faenov, P. O. Bogdanovich, G. V. Merkelis, Z. B. Rudzikas, and S. D. Sadziuviene, *J. Phys. B* **12**, 1927 (1979).
- ¹⁹C. Breton, C. De Michelis, M. Finkenthal, and M. Mattioli, *J. Opt. Soc. Am.* **69**, 1652 (1979).
- ²⁰G. E. Bromage, R. D. Cowan, B. C. Fawcett, H. Gordon, M. G. Hobby, N. J. Peacock, and A. Ridgeley, *The Laser-Produced Spectrum of Fe XVII to Fe XXI Below 18 Å*, CLM-R170 (1977).
- ²¹G. E. Bromage, R. D. Cowan, and B. C. Fawcett, *Phys. Scr.* **15**, 177 (1977).
- ²²G. E. Bromage and B. C. Fawcett, *Mon. Not. R. Astr. Soc.* **178**, 605 (1977).
- ²³G. E. Bromage, B. C. Fawcett, and R. D. Cowan, *Mon. Not. R. Astr. Soc.* **178**, 599 (1977).
- ²⁴G. E. Bromage, R. D. Cowan, and B. C. Fawcett, *Mon. Not. R. Astr. Soc.* **183**, 19 (1978).
- ²⁵G. E. Bromage, R. D. Cowan, B. C. Fawcett, and A. Ridgeley, *J. Opt. Soc. Am.* **68**, 48 (1978).
- ²⁶J. P. Buchet, M. C. Buchet-Poulizac, A. Denis, J. Déséquelles, M. Druetta, J. P. Grandin, and X. Husson, *Phys. Rev. A* **23**, 3354 (1981).
- ²⁷J. P. Buchet, M. C. Buchet-Poulizac, A. Denis, J. Déséquelles, M. Druetta, S. Martin, J. P. Grandin, X. Husson, and I. Lesteven, *Phys. Scr.* **31**, 364 (1985).
- ²⁸J. P. Buchet, M. C. Buchet-Poulizac, A. Denis, J. Déséquelles, M. Druetta, S. Martin, and J. F. Wyart, *J. Phys. B* **20**, 1709 (1987).
- ²⁹P. G. Burkhalter, C. M. Dozier, E. Stallings, and R. D. Cowan, *J. Appl. Phys.* **49**, 1092 (1978).
- ³⁰P. G. Burkhalter, L. Cohen, R. D. Cowan, and U. Feldman, *J. Opt. Soc. Am.* **69**, 1133 (1979).
- ³¹W. M. Burton, A. Ridgeley, and R. Wilson, *Mon. Not. R. Astr. Soc.* **135**, 207 (1967).
- ³²W. M. Burton and A. Ridgeley, *Solar Phys.* **14**, 3 (1970).
- ³³L. F. Chase, W. C. Jordan, J. D. Perez, and R. R. Johnston, *Phys. Rev. A* **13**, 1497 (1976).
- ³⁴S. S. Churilov, E. Ya. Kononov, A. N. Ryabtsev, and Yu. F. Zayikin, *Phys. Scr.* **32**, 501 (1985).
- ³⁵L. Cohen, U. Feldman, and S. O. Kastner, *J. Opt. Soc. Am.* **58**, 331 (1968).
- ³⁶L. Cohen and U. Feldman, *Astrophys. J.* **160**, L105 (1970).
- ³⁷J. P. Connerade, N. J. Peacock, and R. J. Speer, *Solar Phys.* **14**, 159 (1970).
- ³⁸R. D. Cowan and N. J. Peacock, *Astrophys. J.* **142**, 390 (1965).
- ³⁹R. D. Cowan, *Astrophys. J.* **147**, 377 (1967).
- ⁴⁰R. D. Cowan and K. G. Widing, *Astrophys. J.* **180**, 285 (1973).
- ⁴¹J. H. Dave, U. Feldman, J. F. Seely, A. Wouters, S. Suckewer, E. Hinnov, and J. L. Schwob, *J. Opt. Soc. Am. B* **4**, 635 (1987).
- ⁴²K. P. Dere, *Astrophys. J.* **221**, 1062 (1978).
- ⁴³G. A. Doschek, *Space Sci. Rev.* **13**, 765 (1972).
- ⁴⁴G. A. Doschek, J. F. Meekins, and R. D. Cowan, *Astrophys. J.* **177**, 261 (1972).
- ⁴⁵G. A. Doschek, U. Feldman, R. D. Cowan, and L. Cohen, *Astrophys. J.* **188**, 417 (1974).
- ⁴⁶G. A. Doschek, U. Feldman, and L. Cohen, *J. Opt. Soc. Am.* **65**, 463 (1975).
- ⁴⁷G. A. Doschek, U. Feldman, J. Davis, and R. D. Cowan, *Phys. Rev. A* **12**, 980 (1975).
- ⁴⁸G. A. Doschek, U. Feldman, K. P. Dere, G. D. Sandlin, M. E. VanHoosier, G. E. Brueckner, J. D. Purcell, and R. Tousey, *Astrophys. J.* **196**, L83 (1975).
- ⁴⁹G. A. Doschek, U. Feldman, M. E. VanHoosier, and J. D. F. Bartoe, *Astrophys. J. Suppl.* **31**, 417 (1976).
- ⁵⁰G. W. F. Drake, *Calculated Transition Frequencies for Helium-Like Ions*, unpublished (1985).
- ⁵¹A. K. Dupree, M. C. E. Huber, R. W. Noyes, W. H. Parkinson, E. M. Reeves, and G. L. Withbroe, *Astrophys. J.* **182**, 321 (1973).
- ⁵²B. Edlén, *Z. Phys.* **100**, 621 (1936).
- ⁵³B. Edlén, *Z. Phys.* **103**, 536 (1936).
- ⁵⁴B. Edlén, *Z. Phys.* **104**, 188 (1937).
- ⁵⁵B. Edlén, *Z. Phys.* **104**, 407 (1937).
- ⁵⁶B. Edlén, *Z. Astrophys.* **22**, 30 (1942).
- ⁵⁷B. Edlén, and R. Smitt, *Solar Phys.* **57**, 329 (1978).
- ⁵⁸B. Edlén, *Phys. Scr.* **22**, 593 (1981).
- ⁵⁹B. Edlén, *Phys. Scr.* **26**, 71 (1982).
- ⁶⁰B. Edlén, *Phys. Scr.* **32**, 86 (1985).
- ⁶¹G. W. Erickson, *J. Phys. Chem. Ref. Data* **6**, 831 (1977).
- ⁶²B. C. Fawcett and A. H. Gabriel, *Proc. Phys. Soc.* **88**, 262 (1966).
- ⁶³B. C. Fawcett, A. H. Gabriel, F. E. Irons, N. J. Peacock, and P. A. H. Saunders, *Proc. Phys. Soc.* **88**, 1051 (1966).
- ⁶⁴B. C. Fawcett, A. H. Gabriel, and P. A. H. Saunders, *Proc. Phys. Soc.* **90**, 863 (1967).
- ⁶⁵B. C. Fawcett and N. J. Peacock, *Proc. Phys. Soc.* **91**, 973 (1967).
- ⁶⁶B. C. Fawcett, A. H. Gabriel, and C. Jordan, *Astrophys. J.* **152**, L119 (1968).
- ⁶⁷B. C. Fawcett, N. J. Peacock, and R. D. Cowan, *J. Phys. B* **1**, 295 (1968).
- ⁶⁸B. C. Fawcett, *J. Phys. B* **3**, 1732 (1970).
- ⁶⁹B. C. Fawcett, *J. Phys. B* **4**, 981 (1971).
- ⁷⁰B. C. Fawcett, *J. Phys. B* **4**, 1577 (1971).
- ⁷¹B. C. Fawcett, R. D. Cowan, and R. W. Hayes, *J. Phys. B* **5**, 2143 (1972).
- ⁷²B. C. Fawcett, R. D. Cowan, E. Y. Kononov, and R. W. Hayes, *J. Phys. B* **5**, 1255 (1972).
- ⁷³B. C. Fawcett, R. D. Cowan, and R. W. Hayes, *Astrophys. J.* **187**, 377 (1974).
- ⁷⁴B. C. Fawcett, M. Galanti, and N. J. Peacock, *J. Phys. B* **7**, 1149 (1974).
- ⁷⁵B. C. Fawcett and R. D. Cowan, *Mon. Not. R. Astr. Soc.* **171**, 1 (1975).
- ⁷⁶B. C. Fawcett and R. W. Hayes, *Mon. Not. R. Astr. Soc.* **170**, 185 (1975).
- ⁷⁷B. C. Fawcett, G. E. Bromage, and R. W. Hayes, *Mon. Not. R. Astr. Soc.* **186**, 113 (1979).

- ⁷⁸B. C. Fawcett, A. Ridgeley, and T. P. Hughes, *Mon. Not. R. Astr. Soc.* **188**, 365 (1979).
- ⁷⁹B. C. Fawcett, *Atom. Data Nucl. Data Tables* **28**, 557 (1983).
- ⁸⁰B. C. Fawcett, *Atom. Data Nucl. Data Tables* **28**, 579 (1983).
- ⁸¹B. C. Fawcett, *Atom. Data Nucl. Data Tables* **30**, 1 (1984) and Erratum **33**, 479 (1985).
- ⁸²B. C. Fawcett, *Atom. Data Nucl. Data Tables* **31**, 495 (1984).
- ⁸³B. C. Fawcett, *Phys. Scr.* **34**, 331 (1986).
- ⁸⁴B. C. Fawcett, *Atom. Data Nucl. Data Tables* **34**, 215 (1986).
- ⁸⁵B. C. Fawcett, *Atom. Data Nucl. Data Tables* **35**, 185 (1986).
- ⁸⁶B. C. Fawcett, *Atom. Data Nucl. Data Tables* **35**, 203 (1986).
- ⁸⁷B. C. Fawcett, *Atom. Data Nucl. Data Tables* **36**, 129 (1987).
- ⁸⁸B. C. Fawcett, *Atom. Data Nucl. Data Tables* **36**, 151 (1987).
- ⁸⁹B. C. Fawcett, *Atom. Data Nucl. Data Tables* **37**, 367 (1987).
- ⁹⁰B. C. Fawcett, C. Jordan, J. R. Lemen, and K. J. H. Phillips, *Mon. Not. R. Astr. Soc.* **225**, 1013 (1987).
- ⁹¹U. Feldman, B. S. Fraenkel, and S. Hoory, *Astrophys. J.* **142**, 719 (1965).
- ⁹²U. Feldman and B. S. Fraenkel, *Astrophys. J.* **145**, 959 (1966).
- ⁹³U. Feldman and L. Cohen, *J. Opt. Soc. Am.* **57**, 1128 (1967).
- ⁹⁴U. Feldman, L. Katz, W. Behring, and L. Cohen, *J. Opt. Soc. Am.* **61**, 91 (1971).
- ⁹⁵U. Feldman, G. A. Doschek, R. D. Cowan, and L. Cohen, *J. Opt. Soc. Am.* **63**, 1445 (1973).
- ⁹⁶U. Feldman, G. A. Doschek, D. J. Nagel, W. E. Behring, and L. Cohen, *Astrophys. J.* **183**, L43 (1973).
- ⁹⁷U. Feldman, G. A. Doschek, R. D. Cowan, and L. Cohen, *Astrophys. J.* **196**, 613 (1975).
- ⁹⁸U. Feldman and G. A. Doschek, *J. Opt. Soc. Am.* **67**, 726 (1977).
- ⁹⁹U. Feldman, G. A. Doschek, C. C. Cheng, and A. K. Bhatia, *J. Appl. Phys.* **51**, 190 (1980).
- ¹⁰⁰U. Feldman, G. A. Doschek, and R. W. Kreplin, *Astrophys. J.* **238**, 365 (1980).
- ¹⁰¹U. Feldman, G. A. Doschek, and J. F. Seely, *Mon. Not. R. Astr. Soc.* **212**, 41 (1985).
- ¹⁰²M. Finkenthal, R. E. Bell, H. W. Moos, and TFR Group, *Phys. Lett. A* **88**, 165 (1982).
- ¹⁰³M. Finkenthal, R. E. Bell, and H. W. Moos, and TFR Group, *J. Appl. Phys.* **56**, 2012 (1984).
- ¹⁰⁴M. Finkenthal, P. Mandelbaum, A. Bar-Shalom, M. Klapisch, J. L. Schwob, C. Breton, C. De Michelis, and M. Mattioli, *J. Phys. B* **18**, L331 (1985).
- ¹⁰⁵C. F. Fischer and B. Liu, *Atom. Data Nucl. Data Tables* **34**, 261 (1986).
- ¹⁰⁶B. S. Fraenkel and J. L. Schwob, *Phys. Lett. A* **40**, 83 (1972).
- ¹⁰⁷J. R. Fuhr, G. A. Martin, W. L. Wiese, and S. M. Younger, *J. Phys. Chem. Ref. Data* **10**, 305 (1981).
- ¹⁰⁸J. R. Fuhr, G. A. Martin, and W. L. Wiese, *J. Phys. Chem. Ref. Data* **17**, Suppl. 4 (1988).
- ¹⁰⁹A. H. Gabriel, B. C. Fawcett, and C. Jordan, *Nature* **209**, 390 (1965).
- ¹¹⁰A. H. Gabriel, B. C. Fawcett, and C. Jordan, *Proc. Phys. Soc.* **87**, 825 (1966).
- ¹¹¹A. H. Gabriel, W. R. S. Garton, L. Goldberg, T. J. L. Jones, C. Jordan, F. J. Morgan, R. W. Nicholls, W. J. Parkinson, H. J. B. Paxton, E. M. Reeves, C. B. Shenton, R. J. Speer, and R. Wilson, *Astrophys. J.* **169**, 595 (1971).
- ¹¹²H. Gordon, M. G. Hobby, and N. J. Peacock, *J. Phys. B* **13**, 1985 (1980).
- ¹¹³Yu. I. Grineva, V. I. Karev, V. V. Korneev, V. V. Krutov, S. L. Mandelstam, L. A. Vainstein, B. N. Vasilyev, and I. A. Zhitnik, *Solar Phys.* **29**, 441 (1973).
- ¹¹⁴W. Grotrian, *Naturwiss.* **27**, 214 (1939).
- ¹¹⁵E. Hinnov, *Astrophys. J.* **230**, L197 (1979).
- ¹¹⁶E. Hinnov and S. Suckewer, *Phys. Lett. A* **79**, 298 (1980).
- ¹¹⁷E. Hinnov, S. Suckewer, S. Cohen, and K. Sato, *Phys. Rev. A* **25**, 2293 (1982).
- ¹¹⁸K. N. Huang, Y. K. Kim, K. T. Cheng, and J. P. Desclaux, *Atom. Data Nucl. Data Tables* **28**, 355 (1983).
- ¹¹⁹K. N. Huang, *Atom. Data Nucl. Data Tables* **30**, 313 (1984).
- ¹²⁰K. N. Huang, *Atom. Data Nucl. Data Tables* **32**, 503 (1985).
- ¹²¹K. N. Huang, *Atom. Data Nucl. Data Tables* **32**, 1 (1986).
- ¹²²R. J. Hutcheon, J. P. Pye, and K. D. Evans, *Astr. Astrophys.* **51**, 451 (1976).
- ¹²³R. J. Hutcheon, J. P. Pye, and K. D. Evans, *Mon. Not. R. Astr. Soc.* **175**, 489 (1976).
- ¹²⁴J. T. Jefferies, *Mem. Soc. Roy. Sci. Liege. Collect.* **17**, 213 (1969).
- ¹²⁵J. T. Jefferies, F. Q. Orrall, and J. B. Zirker, *Solar Phys.* **16**, 103 (1971).
- ¹²⁶W. R. Johnson and G. Soff, *Atom. Data and Nucl. Data Tables* **33**, 405 (1985).
- ¹²⁷C. Jordan, *Mon. Not. R. Astr. Soc.* **132**, 515 (1966).
- ¹²⁸C. Jordan, *Solar Phys.* **21**, 381 (1971).
- ¹²⁹C. Jordan, *Space Sci. Rev.* **13**, 595 (1972).
- ¹³⁰C. Jupén, *Mon. Not. R. Astr. Soc.* **208**, short communication 1 (1984).
- ¹³¹S. O. Kastner, W. M. Neupert, and M. Swartz, *Astrophys. J.* **191**, 261 (1974).
- ¹³²S. O. Kastner, W. E. Behring, and L. Cohen, *Astrophys. J.* **199**, 777 (1975).
- ¹³³S. O. Kastner, A. M. Crooker, W. E. Behring, and L. Cohen, *Phys. Rev. A* **16**, 577 (1977).
- ¹³⁴S. O. Kastner, M. Swartz, A. K. Bhatia, and J. Lapedes, *J. Opt. Soc. Am.* **68**, 1558 (1978).
- ¹³⁵V. Kaufman and J. Sugar, *J. Phys. Chem. Ref. Data* **15**, 321 (1986).
- ¹³⁶M. Klapisch, J. L. Schwob, B. S. Fraenkel, and J. Oreg, *J. Opt. Soc. Am.* **67**, 148 (1977).
- ¹³⁷M. Klapisch, A. Bar-Shalom, J. L. Schwob, B. S. Fraenkel, C. Breton, C. de Michelis, M. Finkenthal, and M. Mattioli, *Phys. Lett. A* **69**, 34 (1978).
- ¹³⁸E. Ya. Kononov, K. N. Koshelev, L. I. Podobedova, S. V. Chekalin, and S. S. Churilov, *J. Phys. B* **9**, 565 (1976).
- ¹³⁹E. Ya. Kononov, A. N. Ryabtsev, U. I. Safronova, and S. S. Churilov, *J. Phys. B* **9**, L477 (1976).
- ¹⁴⁰E. Ya. Kononov, K. N. Koshelev, and Yu. V. Sidefnikov, *Sov. J. Plasma Phys.* **3**, 375 (1977).
- ¹⁴¹E. Ya. Kononov, V. I. Kovalev, A. N. Ryabtsev, and S. S. Churilov, *Sov. J. Quantum Electron.* **7**, 111 (1977).
- ¹⁴²E. Ya. Kononov, *Phys. Scr.* **27**, 117 (1983).
- ¹⁴³V. I. Kovalev, E. Ya. Kononov, and S. S. Churilov, *Autoionizing Effects in Atoms and Ions*, Dep. of Phys. and Astr., Sci. Committee on Spectros., Acad. Nauk Moscow, USSR, p.210 (1983).
- ¹⁴⁴P. G. Kruger and S. G. Weissberg, *Phys. Rev.* **52**, 314 (1937).
- ¹⁴⁵P. G. Kruger, S. G. Weissberg, and L. W. Phillips, *Phys. Rev.* **51**, 1090 (1937).
- ¹⁴⁶K. D. Lawson and N. J. Peacock, *J. Phys. B* **13**, 3313 (1980).
- ¹⁴⁷K. D. Lawson, N. J. Peacock, and M. F. Stamp, *J. Phys. B* **14**, 1929 (1981).
- ¹⁴⁸T. N. Lie and R. C. Elton, *Phys. Rev. A* **3**, 865 (1971).
- ¹⁴⁹U. Litzén and A. Redfors, *Phys. Scr.* **36**, 895 (1987).
- ¹⁵⁰M. Loulergue and H. Nussbaumer, *Astr. Astrophys.* **24**, 209 (1973).
- ¹⁵¹F. Magnant-Crifo, *Solar Phys.* **31**, 91 (1973).
- ¹⁵²M. Malinovsky and L. Heroux, *Astrophys. J.* **181**, 1009 (1973).
- ¹⁵³J. E. Manson, *Solar Phys.* **27**, 107 (1972).
- ¹⁵⁴D. L. McKenzie, P. B. Landecker, R. M. Broussard, H. R. Rugee, R. M. Young, U. Feldman, and G. A. Doschek, *Astrophys. J.* **241**, 409 (1980).
- ¹⁵⁵D. L. McKenzie and P. B. Landecker, *Astrophys. J.* **254**, 309 (1982).
- ¹⁵⁶C. Mendoza and J. C. Zeippen, *Mon. Not. R. Astr. Soc.* **198**, 127 (1982).
- ¹⁵⁷C. Mendoza and J. C. Zeippen, *Mon. Not. R. Astr. Soc.* **199**, 1025 (1982).
- ¹⁵⁸P. J. Mohr, *Atom. Data and Nucl. Data Tables* **29**, 453 (1983).
- ¹⁵⁹S. Morita and J. Fujita, *J. Phys. Soc. Japan* **52**, 1957 (1983).
- ¹⁶⁰W. M. Neupert, *Solar Phys.* **18**, 474 (1971).
- ¹⁶¹W. M. Neupert, M. Swartz, and S. O. Kastner, *Solar Phys.* **31**, 171 (1973).
- ¹⁶²J. H. Parkinson, *Astr. Astrophys.* **24**, 215 (1973).
- ¹⁶³J. H. Parkinson, *Solar Phys.* **42**, 183 (1975).
- ¹⁶⁴N. J. Peacock, R. D. Cowan, and G. A. Sawyer, *Proc. 7th Int. Conf. on Ionization Phenomena in Gases*, Belgrade 1965 (1967).

- ¹⁶⁵N. J. Peacock, M. F. Stamp, and J. D. Silver, *Phys. Scr.* **T8**, 10 (1984).
- ¹⁶⁶K. J. Phillips, J. W. Leibacher, C. J. Wolfson, J. H. Parkinson, B. C. Fawcett, B. J. Kent, H. E. Mason, L. W. Acton, J. L. Culhane, and A. H. Gabriel, *Astrophys. J.* **256**, 774 (1982).
- ¹⁶⁷J. P. Pye, K. D. Evans, and R. J. Hutcheon, *Mon. Not. R. Astr. Soc.* **178**, 611 (1977).
- ¹⁶⁸A. A. Ramonas, and A. N. Ryabtsev, *Opt. Spectrosc.* **48**, 348 (1980).
- ¹⁶⁹J. Reader, V. Kaufman, J. Sugar, J. O. Ekberg, U. Feldman, J. F. Seely, and W. L. Rowan, *J. Opt. Soc. Am.* **B4**, 1821 (1987).
- ¹⁷⁰H. R. Rugge and A. B. C. Walker, Jr., *Astrophys. J.* **219**, 1068 (1978).
- ¹⁷¹G. D. Sandlin, G. E. Brueckner, V. E. Scherrer, and R. Tousey, *Astrophys. J.* **205**, L47 (1976).
- ¹⁷²G. D. Sandlin, G. E. Brueckner, and R. Tousey, *Astrophys. J.* **214**, 898 (1977).
- ¹⁷³J. F. Seely and U. Feldman, *J. Phys. B* **18**, L797 (1985).
- ¹⁷⁴J. F. Seely and U. Feldman, *Phys. Scr.* **33**, 110 (1986).
- ¹⁷⁵J. F. Seely, U. Feldman, and U. I. Safronova, *Astrophys. J.* **304**, 838 (1986).
- ¹⁷⁶R. Smitt, L. S. Svensson, and M. Outred, *Phys. Scr.* **13**, 293 (1976).
- ¹⁷⁷R. Smitt, *Solar Phys.* **51**, 113 (1977).
- ¹⁷⁸R. Smitt and L. A. Svensson, *Phys. Scr.* **27**, 364 (1983).
- ¹⁷⁹N. Spector, A. Zigler, H. Zmora, and J. L. Schwob, *J. Opt. Soc. Am.* **70**, 857 (1980).
- ¹⁸⁰S. Suckewer and E. Hinnov, *Phys. Rev. Lett.* **41**, 756 (1978).
- ¹⁸¹S. Suckewer and E. Hinnov, *Phys. Rev.* **A20**, 578 (1979).
- ¹⁸²S. Suckewer, *Phys. Scr.* **23**, 72 (1981).
- ¹⁸³L. A. Svensson, *Solar Phys.* **18**, 232 (1971).
- ¹⁸⁴L. A. Svensson, J. O. Ekberg, and B. Edlén, *Solar Phys.* **34**, 173 (1974).
- ¹⁸⁵M. Swartz, S. Kastner, E. Rothe, and W. Neupert, *J. Phys. B* **4**, 1747 (1971).
- ¹⁸⁶M. Swartz, S. O. Kastner, L. Goldsmith, and W. M. Neupert, *J. Opt. Soc. Am.* **66**, 240 (1976).
- ¹⁸⁷S. S. Tayal, *J. Phys. B* **19**, 3421 (1986).
- ¹⁸⁸E. Träbert, R. Hutton, and I. Martinson, *Z. Phys. D* **5**, 125 (1987).
- ¹⁸⁹E. Träbert, P. H. Heckmann, R. Hutton, and I. Martinson, *J. Opt. Soc. Am. B*, (1988), in press.
- ¹⁹⁰J. J. Turechek and H. J. Kunze, *Z. Phys.* **A273**, 111 (1975).
- ¹⁹¹F. Tyrén, *Z. Phys.* **111**, 314 (1938).
- ¹⁹²L. A. Vainshtein and U. I. Safronova, *Phys. Scr.* **31**, 519 (1985).
- ¹⁹³W. J. Wagner and L. L. House, *Astrophys. J.* **166**, 683 (1971).
- ¹⁹⁴K. G. Widing, G. D. Sandlin, *Astrophys. J.* **152**, 545 (1968).
- ¹⁹⁵K. G. Widing, G. D. Sandlin, and R. D. Cowan, *Astrophys. J.* **169**, 405 (1971).
- ¹⁹⁶K. G. Widing, *Nucl. Instr. Meth.* **110**, 361 (1973).
- ¹⁹⁷K. G. Widing, *Astrophys. J.* **197**, L33 (1975).
- ¹⁹⁸K. G. Widing and J. D. Purcell, *Astrophys. J.* **204**, L151 (1976).
- ¹⁹⁹K. G. Widing, *Astrophys. J.* **222**, 735 (1978).
- ²⁰⁰W. L. Wiese, M. W. Smith, and B. M. Glennon, *Nat. Stand. Ref. Data Ser.* **4**, Vol. I (1966).
- ²⁰¹H. Zirin, *Astrophys. J.* **140**, 1332 (1964).
- ²⁰²S. M. Younger and A. W. Weiss, *J. Res. Natl. Bur. Stds.* **79A**, 629 (1975).

8. Acknowledgments

The present research was organized and inspired by Dr. Shikazono, Chairman of the research committee on atomic and molecular data of the Japan Atomic Energy Research Institute, to whom the authors owe special thanks. This work was partially supported by the U.S.-Japan Fusion Cooperation Program and by the Office of Magnetic Fusion Energy of the U. S. Department of Energy (DOE).