

Ion Storage Group, NIST Boulder

R. Bowler, D. Hanneke, J. D. Jost, J. P. Home, Y. Lin, T-R. Tan, D. Leibfried, D. J. Wineland

Scalable quantum registers

- A scalable quantum register must implement all the operations required for QIP
- Must use scalable methods – operations should be combined with information transport.
- Must implement operations in a manner which is consistent with a large-scale device
- Should be versatile – no hardware changes required for different tasks.

With trapped ions, one scalable architecture uses multi-zone traps
– transport of qubits involves moving the qubit ions themselves

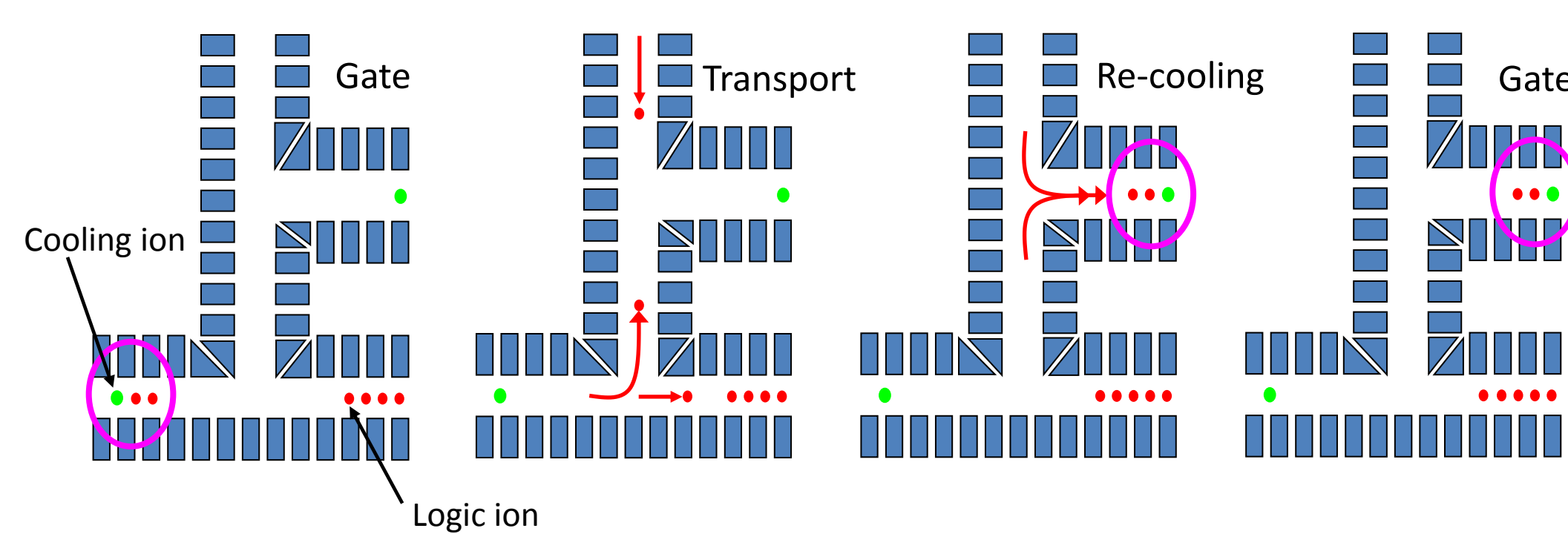

- Requires qubit states robust against environmental perturbations
- Requires recoiling prior to two-qubit gates due to imperfect control of transport and ambient heating (two-qubit gates only work for cold ions)

Arbitrary Control of 2-qubits (universal 2-qubit QIP)

D. Hanneke, *et al*, *Nature Phys.* 6 13-16 (2010)

We implement an arbitrary operation in SU(4) acting on two-qubits
– 15 free parameters are inputs to single qubit gates.
– 3 two-qubit gates required to reach all local equivalence classes

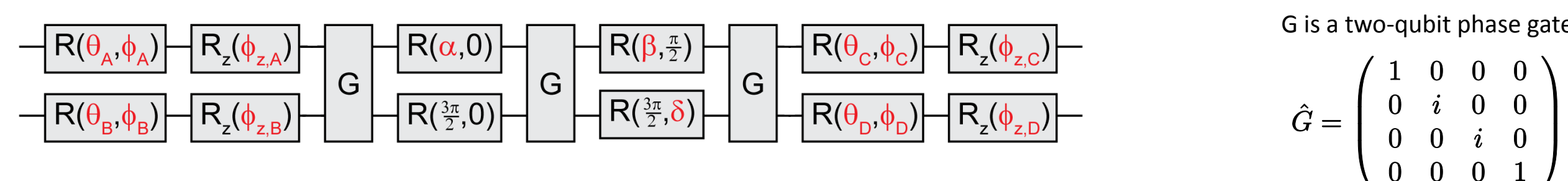

We demonstrate arbitrary control by choosing at random a unitary operator and one of 16 input states. We perform state-tomography on the output, and compare this to the ideal state

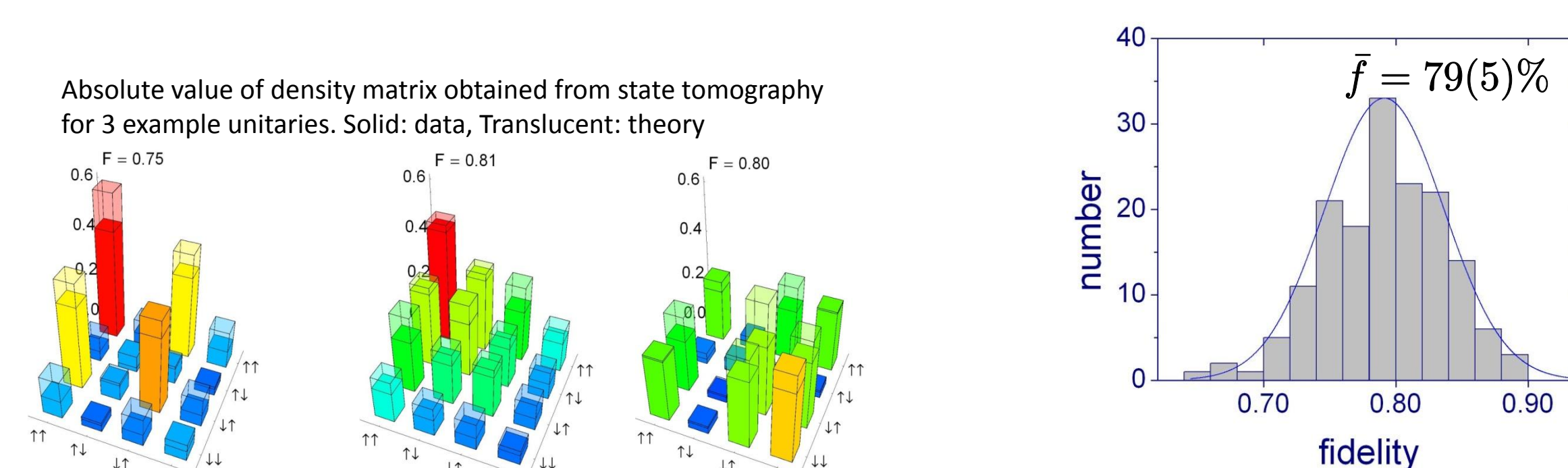

$\sigma_x \otimes \sigma_x$ Phase-Insensitive 2-qubit Gate

Previously, we have been implementing a geometric phase gate which required a differential AC Stark shift and could not operate directly on the field-insensitive qubit, requiring complicated laser pulse sequences.

We have switched to a gate scheme which allows operations directly on our field-insensitive qubit (A. Sørensen and K. Mølmer, *Phys. Rev. Lett.* 82, 1971 (1999)) in a way insensitive to optical phase drifts (P. J. Lee, *et al.*, *J. Opt. B* 7, s371 (2005))

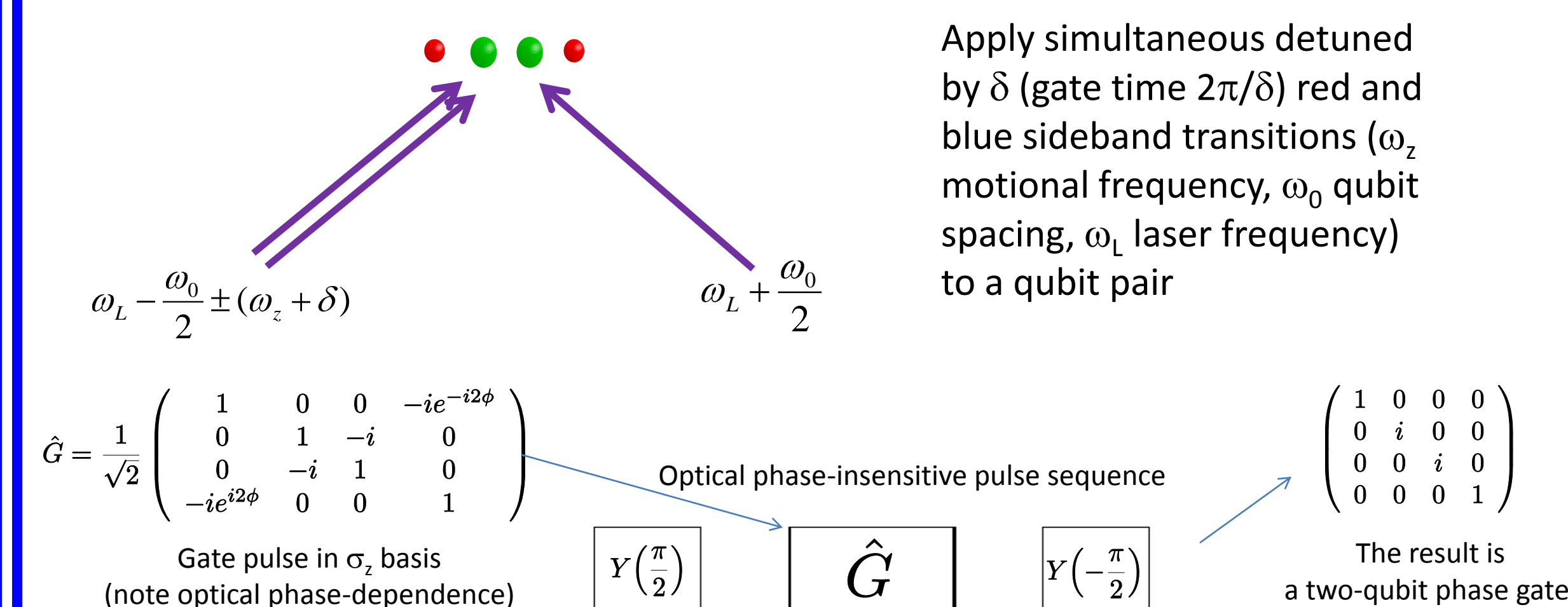

Initial results from the gate acting on logic Be⁺ pair

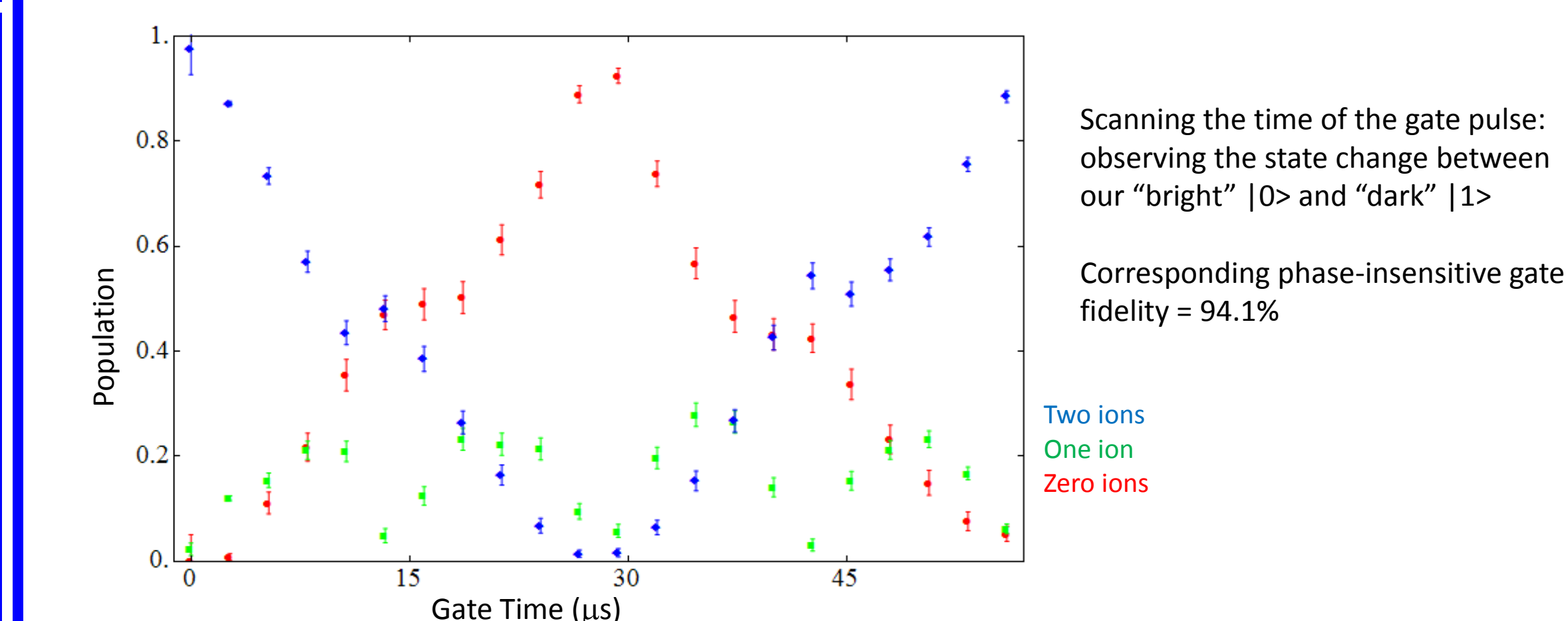

Scanning the time of the gate pulse: observing the state change between our "bright" |0> and "dark" |1>
Corresponding phase-insensitive gate fidelity = 94.1%

Multi-zone trap

Time varying voltages applied to electrodes of a segmented trap allow us to move and separate chains of ions

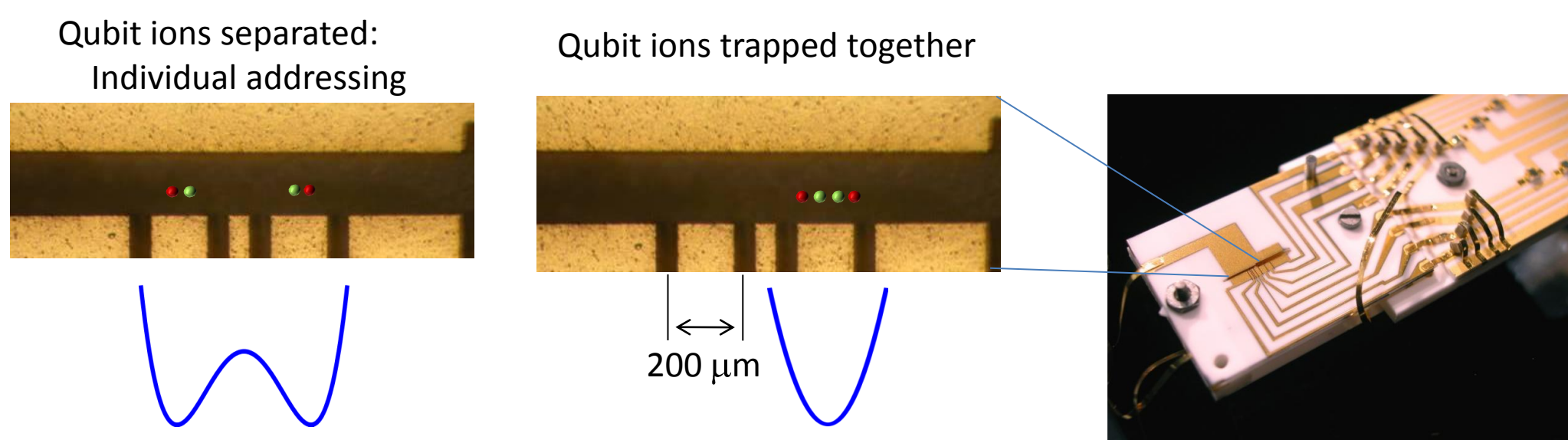

- Qubit readout
- Single-qubit gates
- Two-qubit gates

Ions not to scale

Scalable trapped ion quantum register

Long-lived magnetic fluctuation-insensitive qubits

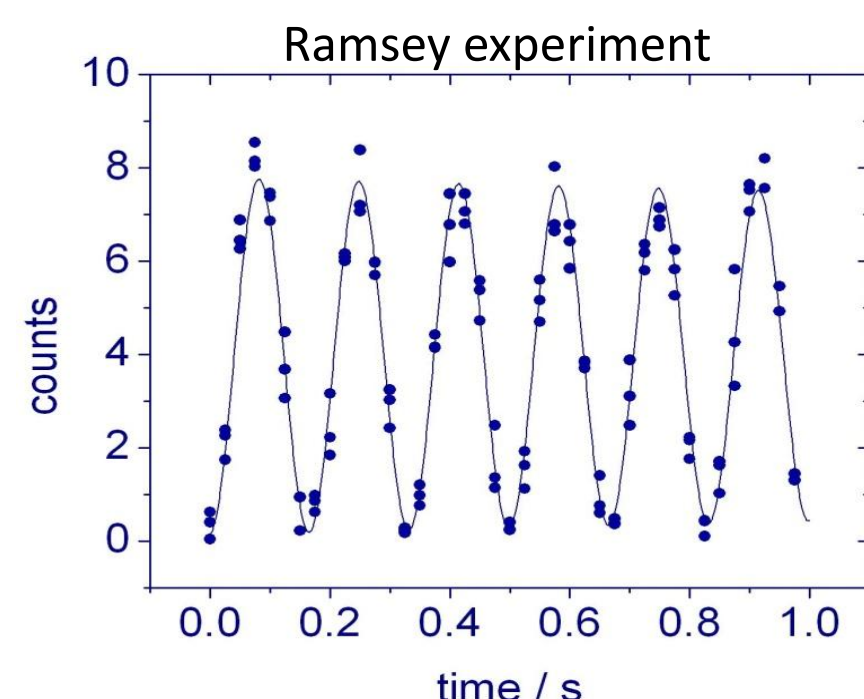

Coherence time ~ 15 s
C. Langer, *et al*, *Phys. Rev. Lett.* 95 060502 (2005)

To control 2 qubits, we use a four ion crystal

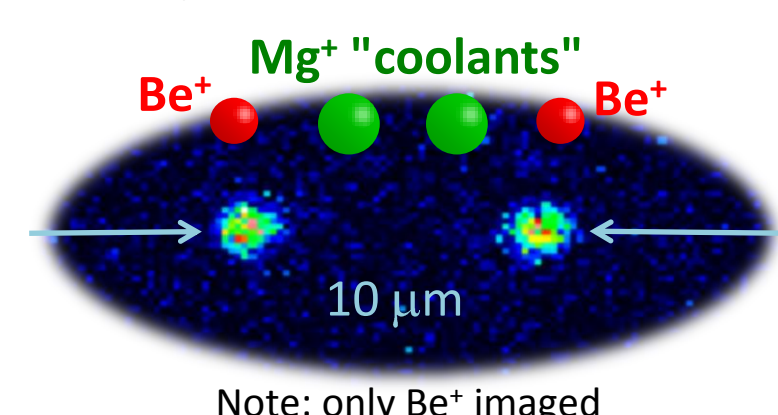

Note: only Be+ imaged

Sympathetic cooling

Cannot directly laser cool qubit ion - destroys qubit coherence
Instead trap two species of ion

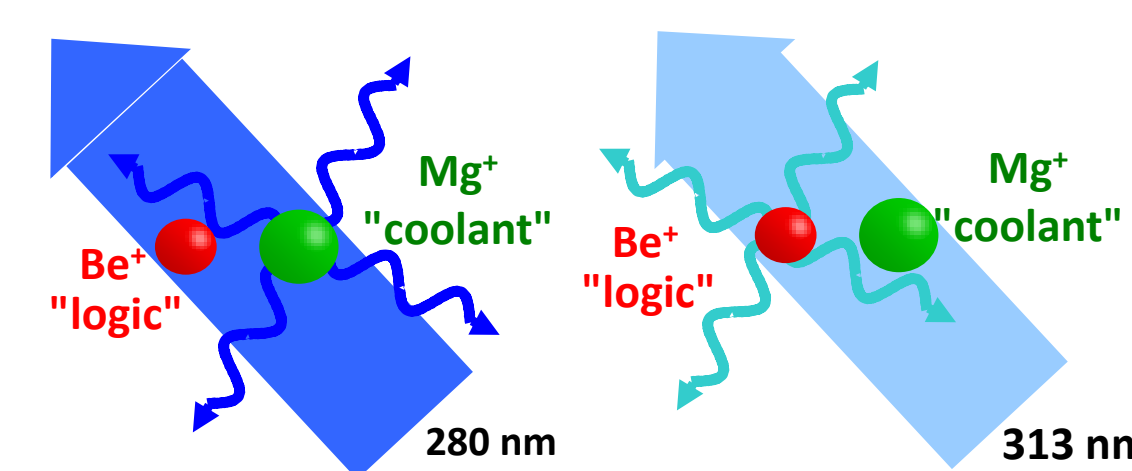

Mg light doesn't couple to internal Be (qubit) states
It can cool the motion of Be, due to the Coulomb interaction

Example of sympathetic cooling: motion-subtracting beryllium sideband can't be driven (cooling all done using magnesium)

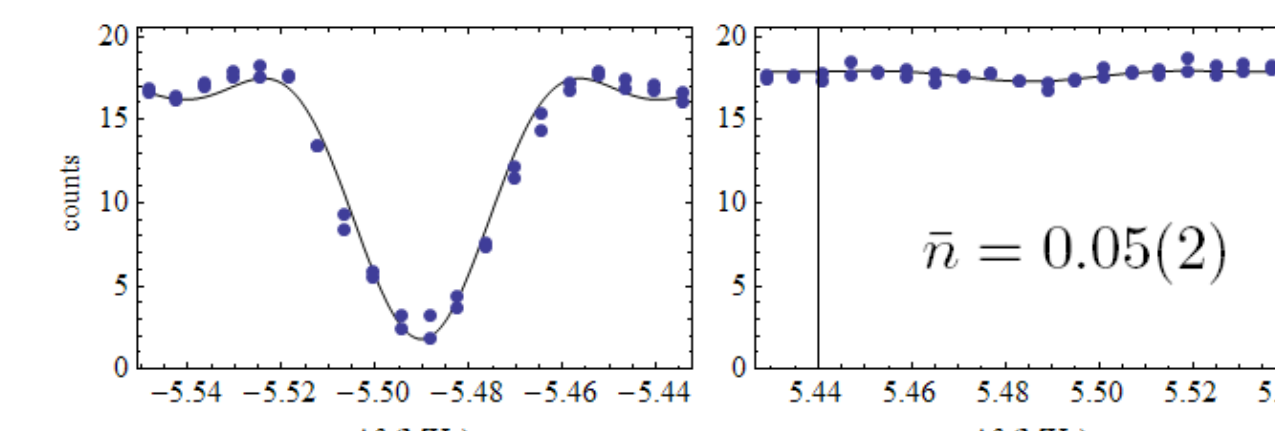

Anharmonic trap potentials

Most work up until now assumes a harmonic potential well. This is generally a good approximation when the electrode size and ion-electrode distance ρ is large compared to the extent of the ion crystal. We observe effects on the motional modes due to higher order terms in the trapping potential, which will become more important with larger crystals and smaller traps.

$$V = \alpha_2 z^2 + \alpha_3 z^3 + \alpha_4 z^4$$

The curvature of the potential is now different at each ion

Odd-order anharmonicity - asymmetry results in different amplitudes for the beryllium ions for our four ion crystal

We observe beating when Rabi flopping on motional sidebands

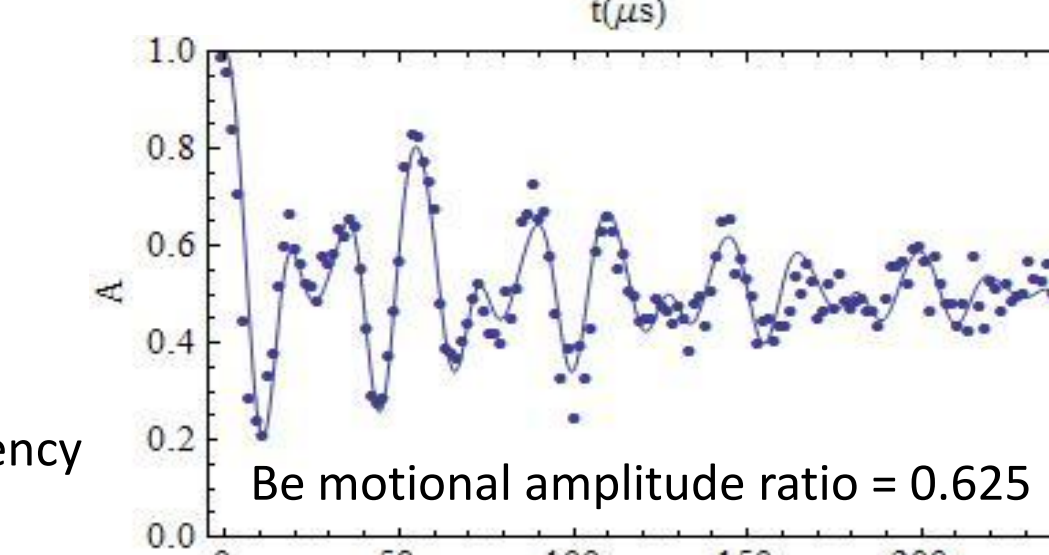
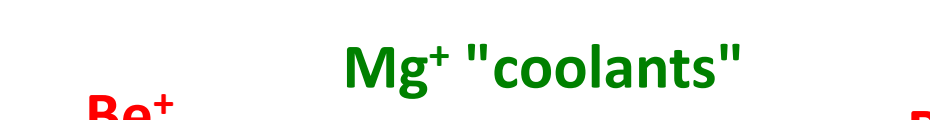
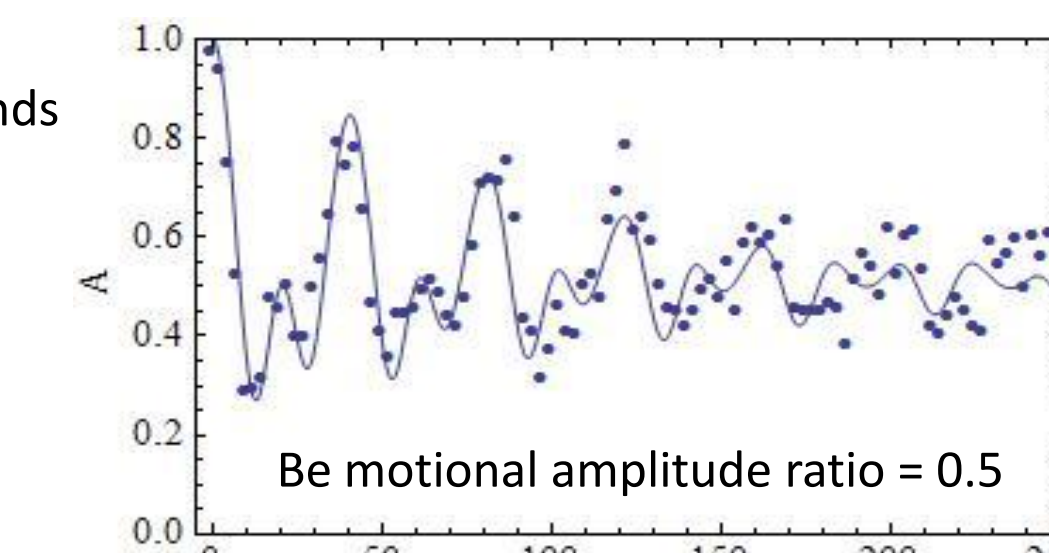
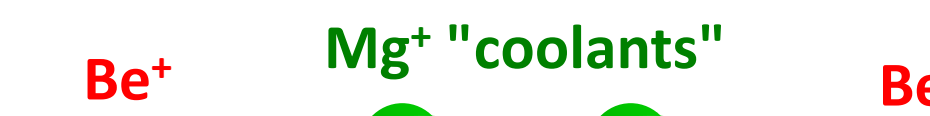

In an asymmetric two-ion crystal there is now a mode frequency shift which depends on the ion order

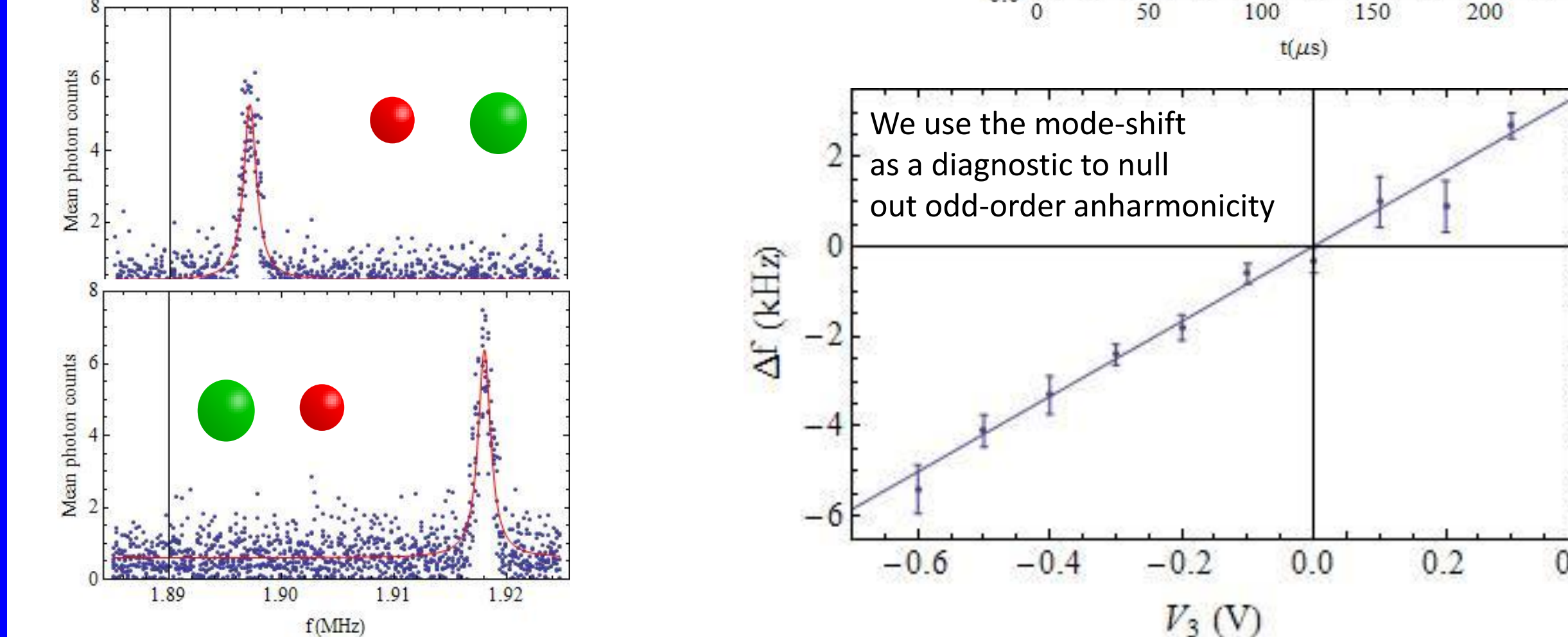

Smooth voltage supplies for fast transport of ions

Operation time limited by transport and cooling

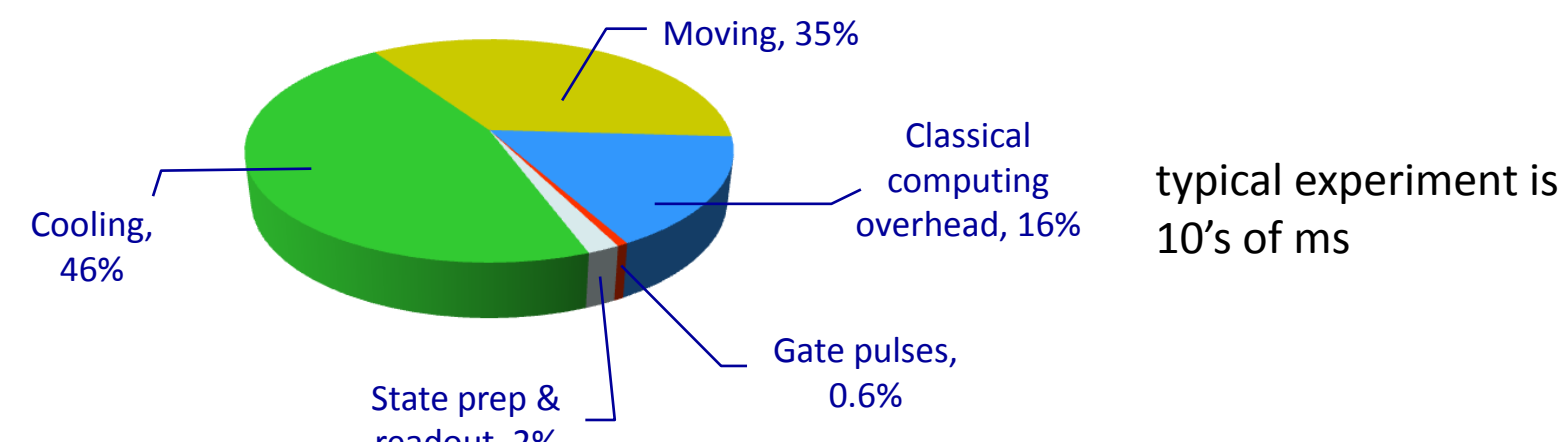

typical experiment is 10's of ms

New home built supply with update rate of 50 MHz >> all ion secular frequencies

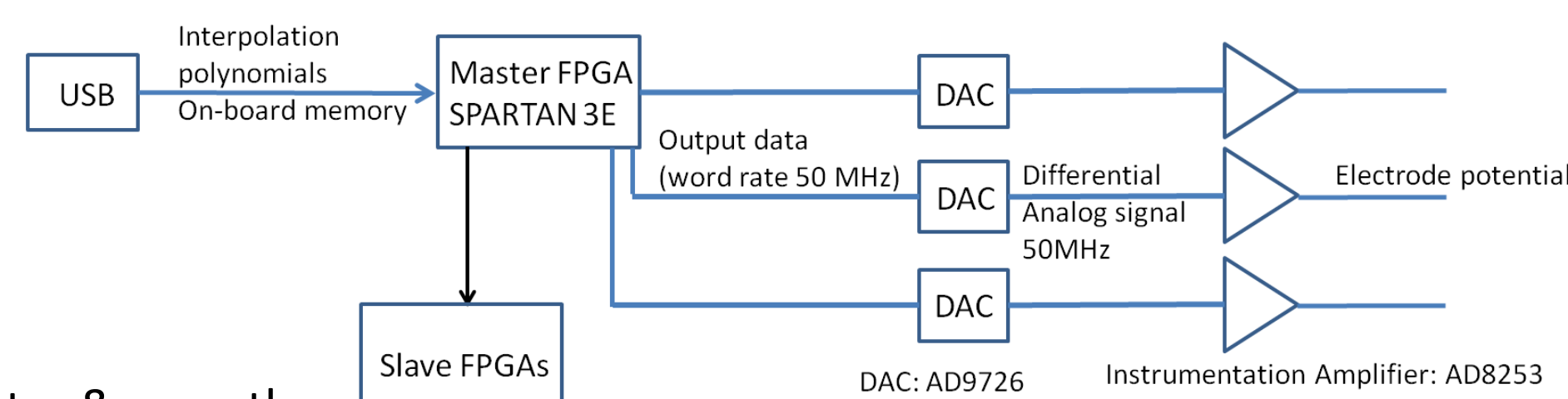

- Faster & smoother
 - 50 MHz versus 500 kHz
 - Speed up transport
 - Less excitation to recool
- Conditional synchronous branching between transport algorithms
- 2-Ion Tests
 - Separate & recombine: < 1 quantum per mode vs ~ 5 quanta
 - Speed up: 5x faster (~1 ms → ~200 μs) gets ~ 5 quanta
 - Next steps: Test on 4 ions, optimize fast waveforms

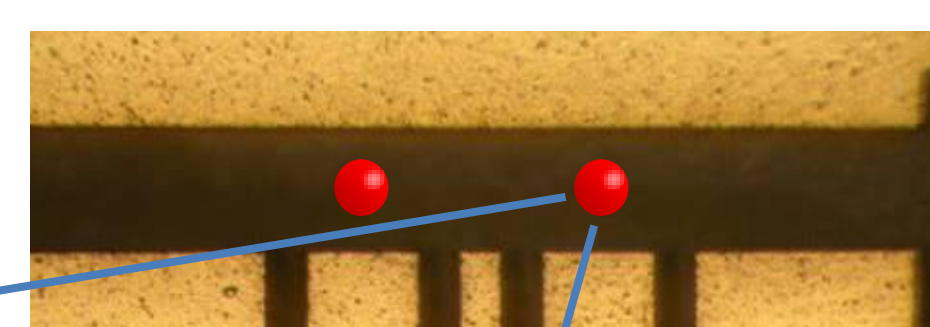

Example of separation analysis: Initialize in $|0,0; n_c = 0, n_s = 0\rangle$
followed by separation (2x faster) followed by motion-adding beryllium sideband Rabi flopping on one ion

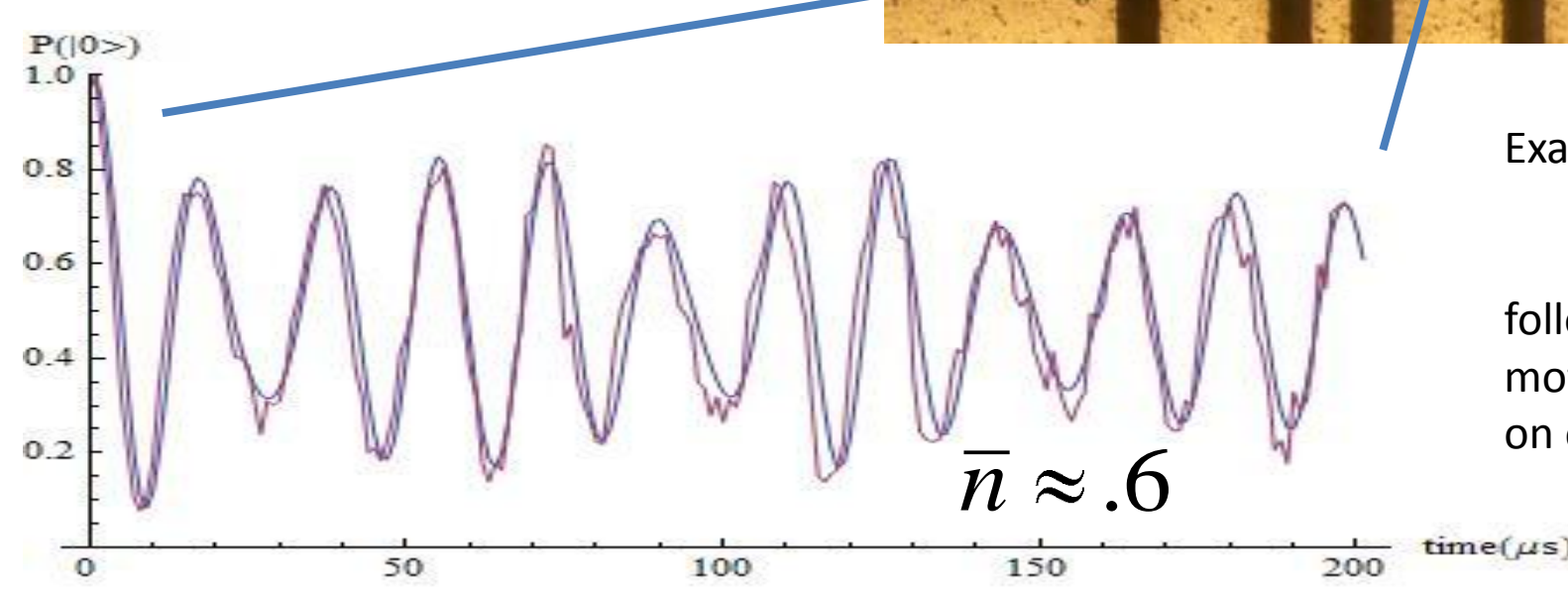

Position Stability

UV laser beams can have significant beam-pointing fluctuations from thermal gradients and air turbulence along beam lines.

- Box-in the laser table to reduce air currents
- Actively stabilize the final meter of beamline (two-axis piezo mirrors and position detectors)
- Next step: water-cool high-power AOMs to reduce convection in the box

