

POLYMERS DIVISION

FY 2000 PROGRAMS AND ACCOMPLISHMENTS

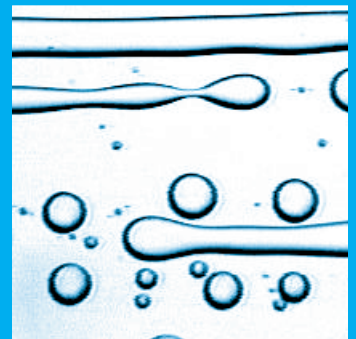
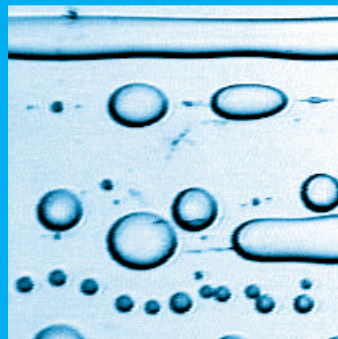
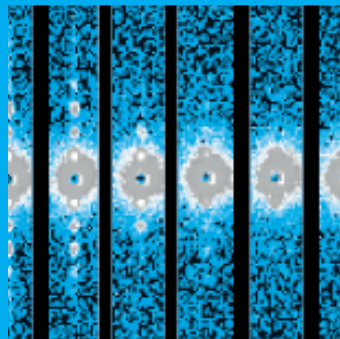
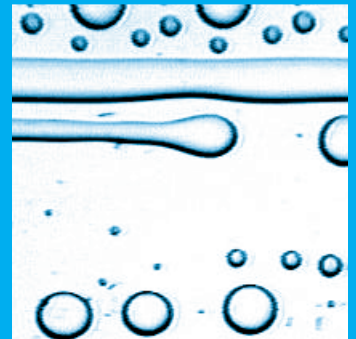
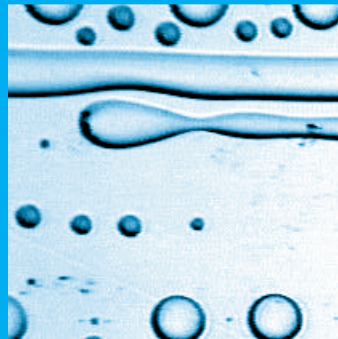
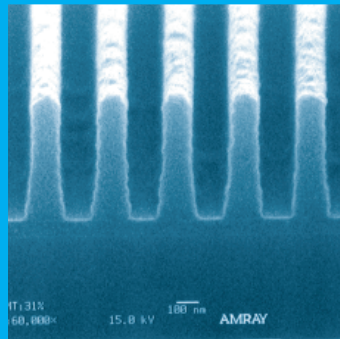
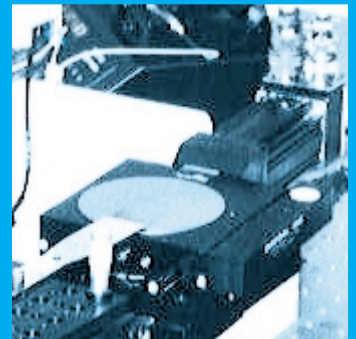
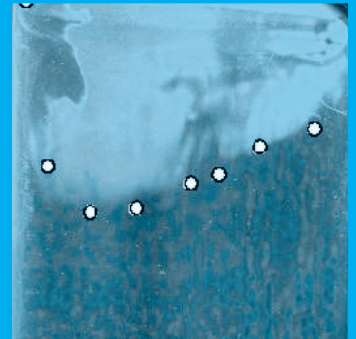

NIST

National Institute of
Standards and Technology

Technology Administration

U. S. Department
of Commerce

NISTIR 6596



Advancements in Measurement Science

Development and application of measurement methods is an integral part of the Polymers Division's projects. Examples in process monitoring, combinatorial methods and neutron scattering are depicted on the cover.

Upper left composite

On-line stroboscopic microscopy captures the action of processing additives during the extrusion of polyethylene. The polyethylene is forced under the action of a twin-screw extruder (upper left of photo) through a sapphire tube (bright cube in center) and into the atmosphere (lower right of photo). The microscope objective is visible beneath the sapphire flow tube.

Lower Right composite

Advances in Process Visualization led to the discovery of "superstrings" in sheared polymer blends. When a blend of polymers droplets in a matrix of a second immiscible polymer is subject to a shearing action between two closely separated plates, there is a massive reorganization of the droplets into large stable strings.

Upper right composite

Direct visual image of the phase diagram of polystyrene and polyvinyl-methylether obtained by depositing a composition gradient orthogonal to a temperature gradient. Data from conventional measurements are shown as open circles. A special apparatus, shown below the visual phase diagram, was constructed to prepare films with gradient compositions and/or thickness by a computer controlled flow coating procedure. Film thickness and composition contours of dried films are mapped using a spot ellipsometer and infrared spectroscopy, respectively.

Lower left composite

Scanning electron micrograph and small angle neutron scattering pattern of a 700 nm thick photoresist film with 150 nm lines. Neutron scattering is explored as a method to quantify lithographic patterns of finer size scales in response to metrology needs of the semiconductor industry as it develops higher speed IC chips.

**UNITED STATES
DEPARTMENT OF
COMMERCE**

Donald L. Evans,
Secretary

**TECHNOLOGY
ADMINISTRATION**

Karen H Brown,
Acting Under Secretary of
Commerce for Technology

**NATIONAL
INSTITUTE OF
STANDARDS AND
TECHNOLOGY**

Karen H. Brown,
Acting Director



MATERIALS SCIENCE AND ENGINEERING LABORATORY POLYMERS

FY 2000 PROGRAMS

AND

ACCOMPLISHMENTS

Eric J. Amis, Chief

Bruno M. Fanconi, Deputy

NISTIR 6596

January 2001

TABLE OF CONTENTS

Executive Summary	1
Technical Activities	
Accomplishments, Impacts And Recognition	
Off-Shore Oil Industry Benefits From New Tools for Design of Composite Structures	3
Fluorescence Based Temperature Measurements Impact Industrial Polymer Processing	5
New Tools In The Battle Against The “Sharkskin” Instability In Polymer Extrusion	7
Polymer Reference Materials for Calibration of Instruments and for Benchmarking	9
Nitric Acid-Modified N-Phenyliminodiacetic Acid – A Total Self-Etching Primer for Bonding to Tooth Structure	11
Combinatorial Measurements of Phase Separation and Dewetting in Polymer Films	13
Structure and Property Measurements of Porous Low-k Dielectric Thin Films	15
Polymer Composite Dielectrics Enable Development Of Embedded Decoupling Capacitance Technology For High Speed Electronics	17
Projects and Programs	
Combinatorial Methods	20
Combinatorial Study of Surface Patterns in Thin Block Copolymer Films	21
High-Throughput Measurements of the Film Properties of a Crystalline- Amorphous Polymer Blend	22
Pattern Formation in the Crystallization of Polymer Blend Films	23
Polymeric Templates for Combinatorial Assay of Cellular Reception	24
Twin-screw Extrusion of Biocompatible Polymers for Tissue Engineering	25
Polymeric Substrates for Laser Capture Microdissection (LCM)	26
Dental And Medical Materials Program	28
A Moldable, Resorbable, Macroporous, Composite Bone Graft Containing Growth Factor	29
Bioactive Polymeric Composites for Mineralized Tissue Regeneration	30
Structure-Property Relationships in Dental Polymers	31
Materials For Microelectronics Program	32
Photolithography	33
Permittivity of Polymer Films in the Microwave Range	34
Characterization of Porous Low-k Dielectric Constant Thin Films	35
Measurement of In-Plane CTE and Modulus of Polymer Thin Films	36
Electronic Paper	37
Hygrothermal Expansion of Polymer Thin Films	38
Assembly of IC Chips Using Wafer-Level Underfill	39
Multiphase Polymeric Materials Program	40
Constitutive Relationship of Polymer Blends for Process Modeling Needs	41
Characterization and Modeling of Interfaces and Interphases of Polymeric Systems	42

Synergistic Interactions Of Polymers With High Surface Area Nanofillers -----	43
Mechanics of Fiber and Nano-Filled Composites -----	44
Structure-Property Characterization and Modeling -----	45
Modification of the Phase Stability of Polymer Blends by Filler Additive -----	46
Nanofiller-Induced Suppression of Dewetting in Thin Polymer Films -----	47
Polymer Characterization Program -----	48
Optical Coherence Tomography for Material Characterization -----	49
Advanced Metrology for Surface and Interface Chemical Analysis -----	50
Molecular Mass Distribution of Polymers by Mass Spectrometry -----	51
Standard Test Method Development -----	52
Non-Newtonian Standard Reference Materials for Rheology -----	53
Support for the Biomaterials Integrated Products Industries -----	54
Semicrystalline Polymer Structure by Small Angle Scattering -----	55
Partitioning of Chain Defects in Isotactic Polypropylene -----	56
Morphology of Ultra-thin Films of Semi-crystalline Polymers by TEM -----	57
NMR Characterization of Nylon-6/Clay Nanocomposites -----	58
Real-Time Monitoring of Biaxial Stretched Film -----	59
Extrusion Visualization Facility Sheds Light on Processing -----	60
“Superstring” Structures During Micro-Scale Processing -----	61
Interfaces in Fiber Reinforced Polymer Composites -----	62
Fiber Optic Flow and Cure Sensing for Liquid Composite Molding -----	63
Publications -----	64
Staff And Organizational Structure	
Research Staff -----	76
NIST Organization Chart -----	85
MSEL Organization Chart -----	85
Polymers Division Organizational Chart -----	86

Certain commercial materials and equipment are identified in this report in order to specify adequately the experimental procedures. In no case does such identification imply recommendation or endorsement by the National Institute of Standards and technology (NIST) nor does it imply necessarily the best available for the purpose.

Executive Summary

From electronics and health care to automotive, infrastructure, and consumer products, polymers (or "plastics" as the TV commercial says) are an increasing part of global economic growth of U.S. industry. The increasing role of polymeric materials in rapidly growing industrial markets, and as replacements for traditional materials, creates a particular challenge to our Division. We continue to evaluate our technical programs to respond to the measurement needs stimulated by new materials formulations and their innovative uses. Furthermore, the rapid pace of change demands new ways of serving our customers, both long-established and new. We continue to support our traditional customers, for example in the chemicals, processing, and automotive industries, at the same time as we strengthen our activities in electronics and health care. Likewise, as a measurements laboratory that continues to provide the data that "sets the standard" we are pioneering in areas of combinatorial methods, mass spectrometry, advanced scattering techniques, and new imaging methods in anticipation of future opportunities.

The Division undertook a major structural reorganization during the past year in order to respond to a changing research environment and to anticipate evolving priorities. Similar to trends in academic centers and industrial laboratories our new organizational structure features teams that are formed and dissolved in response to needs and opportunities.

Five research areas (Electronics Materials, Biomaterials, Multiphase Materials, Processing Characterization, and Combinatorial Methods) are identified as focused teams. For their highest priority projects these groups collaborate with people from across the Division. In addition to focused teams we staff a central Characterization and Measurement Group that is working to develop and extend measurement capabilities and develop reference materials. Across the Division there are many new examples of projects with time, facilities, and expertise shared between the groups.

The style of the annual report is also different this year. The Division's work is presented as project updates from continuing projects and reports on completed projects. These are grouped according to the Materials Science and Engineering Laboratory programs in which we participate, including Materials for Microelectronics, Multiphase Polymeric Materials, Dental and Medical Materials, Polymer Characterization, and Combinatorial Methods. At the beginning of the report we have also included special highlights of accomplishments from eight projects. The highlighted projects include the following.

- In collaboration with the University of Houston, a computer model has been developed to predict vibration effects on composite drilling and production risers used by the offshore oil industry. We have provided new test methods and data to validate the modeling.
- Our fluorescence based, spatially resolved temperature measurement was demonstrated on a complex reactive extrusion line in a Dow Chemicals Company plant. The tests identified an unknown and detrimental excursion above the resin degradation temperature that can arise from shear heating in the processing line.
- The NIST Extrusion Visualization Facility was used in collaboration with 3M to watch the actions of polymer processing additives (PPA) as they are used to eliminate the processing defect known as sharkskin. We have provided the first quantitative measurement tools with which to gauge PPA performance.
- We added three new polyethylene Standard Reference Materials this year. A total of six SRM's from 6000 u to 200,000 u are now available only from NIST. Virtually all U.S. manufacturers of polyethylene purchase NIST molecular mass standards. We have also released the first reference biomaterial, an orthopedic grade ultrahigh molecular weight polyethylene.

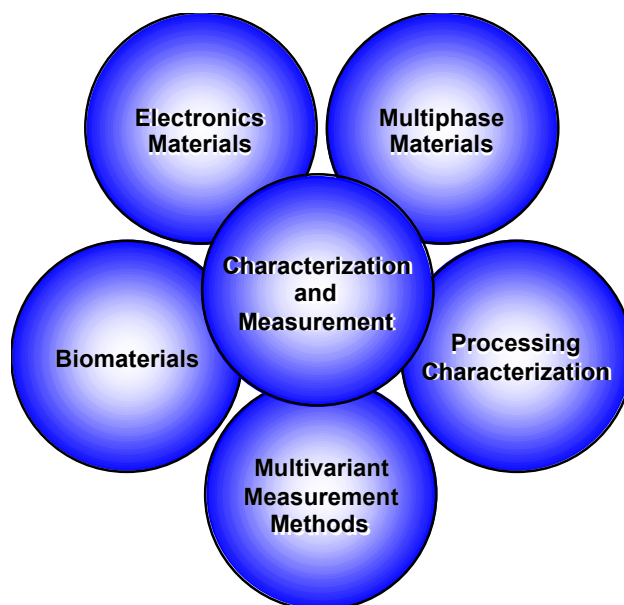

- In collaboration with the American Dental Association Health Foundation we have filed a patent on a new self-etching primer that is applicable to both dentin and enamel with identical bond strength. This promises to provide a much less complex adhesive system for use by practicing dentists.
- We have developed a unique approach to the application of combinatorial methodology for investigation of polymer thin films and coatings. This work has demonstrated the promise of a rapid, broad-based, generalizable approach to high-throughput measurements in polymer materials science.
- We have developed novel methodology for on-wafer measurements of the physical and structural properties of porous thin films that are being developed for use as low-k dielectric materials in the semiconductor industry. The NIST measurements are providing the standard for comparison of all other techniques.

Across the board we have high expectations founded in a long history of impressive accomplishments. As we look forward to the NIST Centennial year of 2001, we know that the Polymers Division will continue to achieve excellence, and we strive with enthusiasm to be the best laboratory in the world for fundamental measurements in polymer science.

Eric J. Amis
Chief

Although this has been a year of transitions for the Division, it has also been a very productive year. We continue to attract excellent scientists from the U.S. and internationally as guest researchers. In the 2000 competition, eight new National Research Council postdoctoral associates joined the Division. We continue to produce world-class research with another increase in technical publications to a total of 175 from the Division in FY2000. We extend the reach of our work by presentations at a broad range of venues.

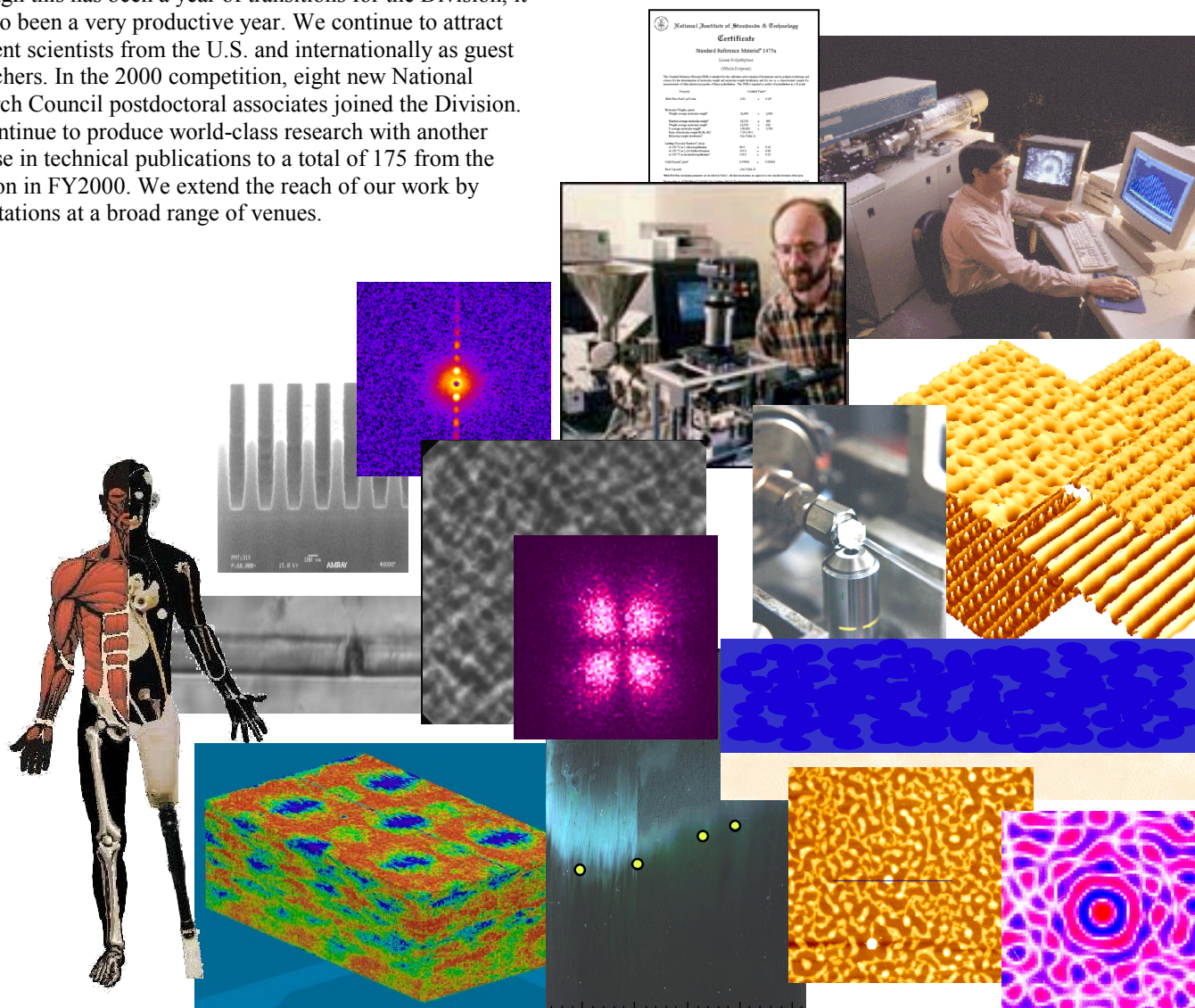

Off-Shore Oil Industry Benefits From New Tools for Design of Composite Structures

The off-shore oil industry needs the light weight of composite structures if it is to retrieve the vast supply of oil that exists in deep water deposits. In the last five years, fabricators have made composite components such as drilling and production risers, but their light weight can magnify problems such as harmful vibrations induced by waves and currents. A joint program between NIST and the University of Houston has provided the first tools that allow industry to simultaneously optimize material selection and structural design to control unwanted vibrations in drilling and production risers. The basic material property data are generated by NIST and used in a computer model developed by the University of Houston to predict vortex-induced vibrations so the effects of changes in material and design can be determined.

Many industries are seeking to take advantage of the weight reductions that can be achieved by replacing metal components and structures with polymer composites. Although this substitution is often successful, one complication that can arise is a change in dynamic response of the structure. In some cases this can be advantageous, as has been found for certain drive shaft applications, but in other instances the changes may cause problems. Unlike metals, however, composites have excellent damping properties that can be used to help control any unwanted vibrations produced by external dynamic loading. Moreover, the great flexibility available in composite structures through changing both materials and designs can be used to alter damping and resonance properties in desirable ways. To take advantage of this flexibility, however, requires a model that predicts behavior of the structure from the properties of the constituents and the design, data on properties of the constituent materials, and knowledge of how these properties relate to the material's composition and morphology.

An important example of this general problem occurs in off-shore oil drilling. The U.S. needs to reduce its dependence on foreign oil and most of the known reserves are in deep water (below 600 m). The light weight of composite structures is critical for industry to build drilling and production risers that can reach these depths. Industry has developed the technology to make risers, but calculations show that the reduced weight shifts the dynamic response of the structure into a range where interactions with currents and waves could be a problem. This dynamic response of the riser is called vortex induced vibration (VIV), and a commercial software program is used to analyze VIV in riser design. Unlike metal risers, however, composite structures have material damping capability that can counteract problems related to VIV. Unfortunately, the currently available software program does not have the capability to include material damping since it is not a factor with metal structures.

NIST and the University of Houston have addressed this issue as part of a joint program on composite structures. The University of Houston has developed an analysis code that

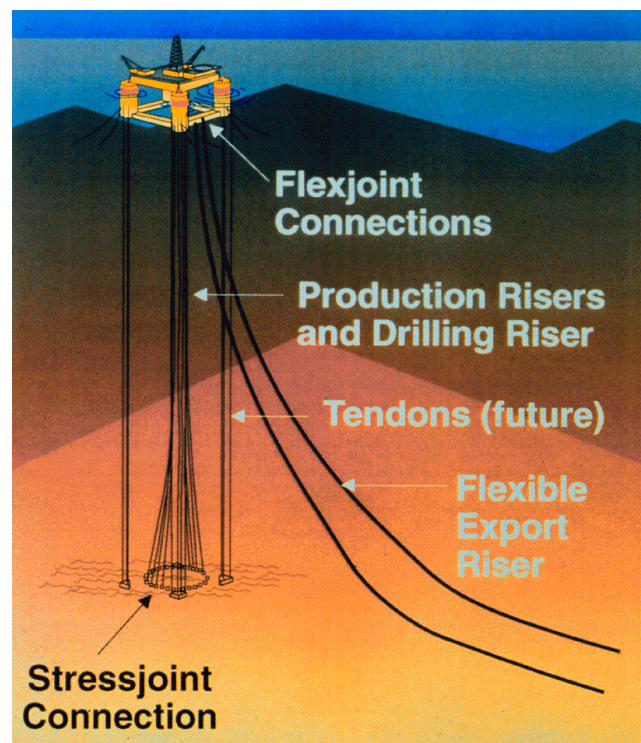
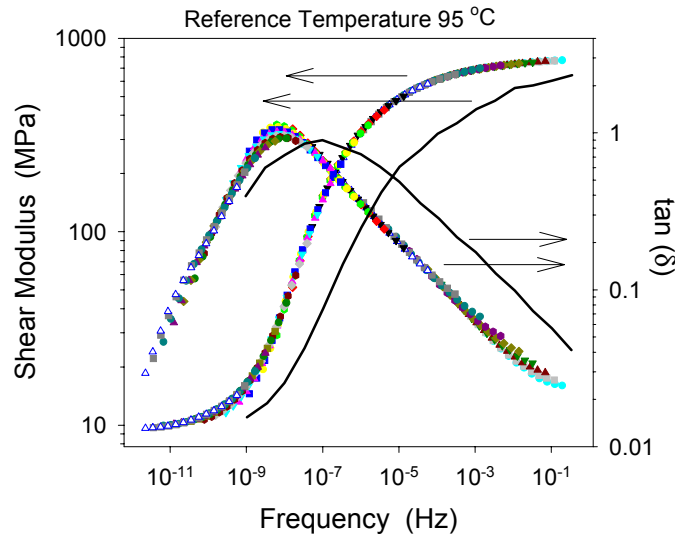

Diagram of off-shore oil platform showing risers

can predict vibrational motions in drilling or production risers from a knowledge of design and material properties. NIST has utilized its capabilities to characterize the dynamic mechanical behavior of various resin systems since they are the source of damping in a composite structure. For the VIV analysis, material property data are needed over a relatively modest range of parameters. For example, the frequencies of interest extend from 0.001 Hz to 20 Hz. In order to improve the response of a material or select a better material, however, it is essential that the behavior be understood in terms of molecular structure and morphology. This requires a knowledge of properties over a much wider range of

parameters. Fortunately, time-temperature superposition can often be applied to the data so results over a wide range of frequencies can be obtained. This is illustrated in the figure below where the overlapping points are data generated by NIST for the resin system now being considered for use in risers. By superimposing data at various temperatures, a master curve was generated that predicts the behavior over a wide range of frequencies. This curve shows that the damping in the range of interest for risers can be attributed to the tail of the $\tan \delta$ peak, which is associated with the glass transition temperature, T_g . Based on this, we formulated and tested a second resin system (solid curves in the figure) that contained a small amount of an elastomeric additive. The additive has some compatibility with the resin so in addition to creating a second phase, it also broadened the glass transition and the corresponding $\tan \delta$ peak for the resin T_g . As a result, the damping in the range of interest is increased. When this resin system was used in the analysis of vibration for a riser, the behavior was significantly improved.



Curves generated by time-temperature superposition for one of the resins currently being used in riser systems (overlapping points) and a second system which was modified to increase the damping ($\tan \delta$) in the range from 1 Hz to 10^{-4} Hz.

This one example provides only a small glimpse of the possibilities available through proper formulation of the resin system. By varying the structure of the resin, the concentration of the additive, and the degree of phase separation, very large changes in the vibrational and damping behavior of the resin can be achieved. Consequently, the material can be designed to give outstanding performance in a riser.

Chevron, Conoco, and Halliburton, are among the companies with interest in a follow up program to explore optimizing vibrational behavior in risers structures.

For More Information

S. S. Wang, J. G. Williams, and D. L. Hunston, "Composite Materials for Offshore Operations", Proceedings of the Third International Workshop, NISTIR, 2001.

On This Topic

Donald Hunston and Carl Schultheisz

Fluorescence Based Temperature Measurements

Impact Industrial Polymer Processing

Temperature is the most important parameter for controlling and modeling polymer processing. It plays a fundamental role in determining flow characteristics, degradation phenomenon, phase transitions, and morphology of the final product. Accurate measurements of resin temperature are not obtained using conventional methods such as thermocouples because such devices are unduly influenced by the large thermal mass of the processing machine. Resin and machine temperatures are never the same because the viscous resin dissipates energy during flow causing its temperature to increase significantly, sometimes approaching the degradation threshold. Our method to measure the true resin temperature is based on fluorescence spectroscopy. The technique has implications for materials testing, for development of processing strategies and for process control.

A new method for measuring temperature of a resin during processing has been developed. The technique addresses a long standing problem in polymer processing and materials testing to obtain accurate and true resin temperatures. Although measurements using thermocouples are the standard practice, it is well known that this measurement does not reflect the resin temperature because the device is unduly influenced by the large thermal mass of the processing machine. During processing, heat is dissipated in the resin by virtue of its own viscosity or by chemical reactions. Since temperature is the most important parameter for understanding and controlling the process, it must be measured accurately.

The new method is based on fluorescence spectroscopy and uses a temperature sensitive fluorescent dye that is doped into the resin. Concentration of dye in resin on the order of a mass fraction of 10^{-6} dye is sufficient for using fluorescence spectra as a monitoring tool. When mixed with the resin at elevated temperatures, the dyes are soluble in the resin matrix so that the dye is completely surrounded by the resin at the molecular level. The concept regarding fluorescent dyes is that they are molecular probes, i.e., they respond to the molecular environment in which they exist and report conditions of the environment via their spectra. Thus, a fluorescence temperature is a true resin temperature.

Sensor hardware for interfacing with polymer processing machines consists of optical fibers that are inserted into existing instrumentation ports in the machine. For example, the standard half-inch sensor bolt for thermocouple or pressure transducers can be adapted to receive optical fibers. The fibers are used to transmit excitation light to the resin, to collect the resultant fluorescence light, and to transmit it to the detector. The NIST sensor head has been fitted with confocal optics so that temperature profiles of a resin flow stream can be obtained.

Two dyes we have used for process monitoring are perylene and benzoxazolyl stilbene (BOS).

Temperature sensitivity of the dyes arises from the fact that probabilities of fluorescence decay from an excited state to different ground state energy levels are temperature dependent. This is illustrated in the spectral plot of polycarbonate doped with perylene. The data taken at various temperatures between 180 °C and 295 °C display a continuous change in shape with increasing temperature.

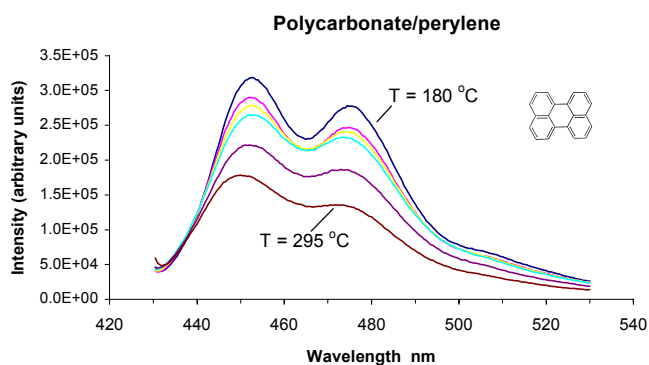

The fluorescence spectrum of the dopant die molecule is temperature sensitive. Its key spectral features are measured on-line during processing.

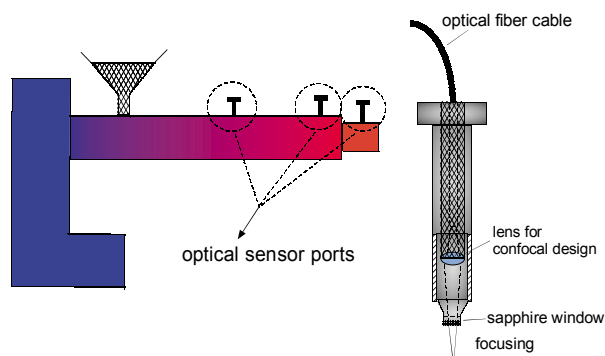

The optics is rugged and compact enough to fit into the standard extrusion instrumentation ports.

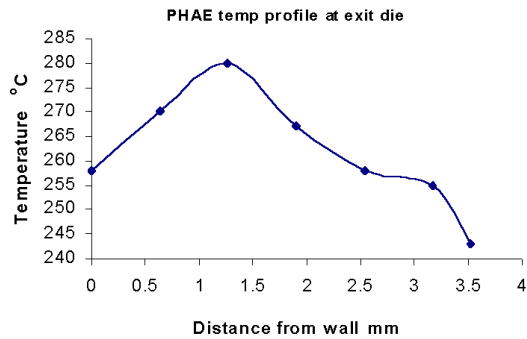

Temperature profiles during the reactive extrusion of a polyhydroxyl alkyl ether (PHAE) doped with BOS dye reveal new information about this process that can be used to avoid resin degradation and produce a higher quality product.

An important application of the technology is temperature monitoring during reactive extrusion. The NIST confocal temperature sensor was positioned at the exit die of an extruder for this measurement. The standard uncertainty in the temperature data is ± 2 °C. The higher temperatures at 1.5 mm from the wall are due to a combination of shear heating and the exothermic chemical reaction.

In another application of the confocal temperature sensor, a capillary rheometer was instrumented as shown below. Here, excitation light was focused on the extrudate, polyethylene doped with perylene. The objective is to obtain viscosity as a function of shear rate at a constant temperature. The test provides basic materials rheological data that are used by U. S. polymer processors, particularly injection molders, to simulate process flows. This is an important step in setting up a new process and the simulation requires accurate input data. But, in order to use the results from this test, the data must be corrected for shear heating effects that occur at high shear rates. A temperature correction has not been possible heretofore because an accurate temperature measuring method has not been available. The impact of these new findings and the NIST measuring technique will be to change materials testing protocols so that accurate rheological data are made available for applications such as simulation software and process modeling.

Collaborations with Mobil Chemical, DOW Chemical and Datapoint Labs are yielding important information that is impacting on processing strategies and understanding.

Capillary Rheometer

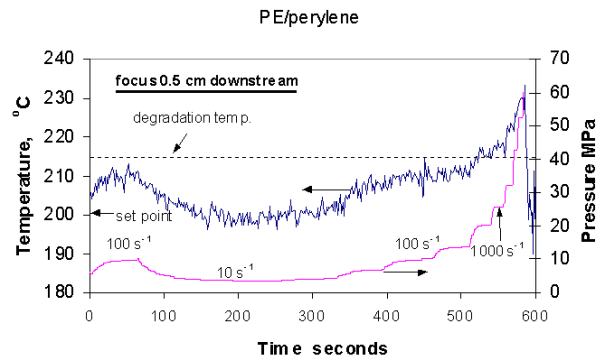
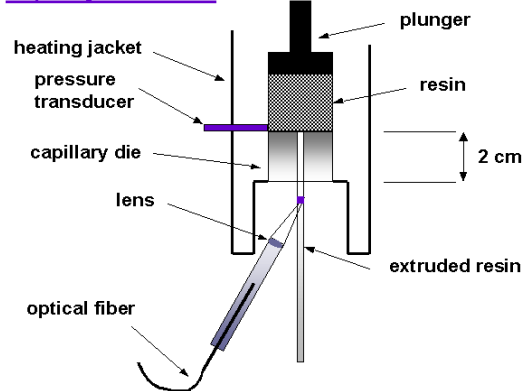

Errors in viscometric data from failure to account for shear heating lead to inaccurate modeling of the extrusion and injection molding processes. At shear rates above 1000 s⁻¹, resin temperature was above degradation threshold.

“Fluorescence based temperature measuring methods developed by NIST address a long standing problem for obtaining accurate resin temperatures during rheological characterization.”... Hubert Lobo, Datapoint Labs

“Accurate measurements of resin temperature gradients during extrusion processing have not been possible in the extruder barrel until the development of the NIST fluorescence based method.”.....Walter Buzanowski, an Analytical Leader in the Analytical Sciences Lab of The Dow Chemical Company.

For More Information

On This Topic

“Fluorescence Based Temperature Measurements and Applications to Real-Time Polymer Processing”, A. J. Bur and S. C. Roth, Proc. Soc. Plastics Eng. Annual Technical Mtg., May 2000.

“Fluorescence Based Measurement of Temperature Profiles during Polymer Processing”, K. Migler and A. J. Bur, Polym. Eng. Sci. 38, 213 (1998).

Anthony J. Bur and Kalman Migler

New tools in the battle against the “sharkskin” instability in polymer extrusion

The throughput of widely used polyolefins is limited by a processing defect known as “sharkskin,” which is a flow instability that causes an undesirable surface roughness on the extruded polymer. Polymer processing additives (PPAs) are commonly used to eliminate sharkskin, and hence are an enabling technology for the polyolefin industry. However, the mechanism by which they work is unclear, hindering development of next generation additives. We developed a capillary rheo-optics technique to visualize how PPAs eliminate sharkskin. We successfully monitored the coating of the PPA onto the internal surface of the capillary die wall and also measured extraordinary levels of slippage between the PPA and the polyolefin. These results provide the first quantitative measurement tools with which to gauge PPA performance.

A substantial effort to understand and overcome sharkskin has been underway since it was first reported over 40 years ago. Sharkskin is a surface roughness that occurs in the extrusion of certain polymers such as linear low density polyethylene. (See photograph below). In the 1960s, the accidental discovery that sharkskin could be reduced or eliminated by the incorporation of a fluoropolymer polymer processing additive (PPA) allowed processors to increase throughput, reduce energy consumption, and enhance processing quality. Since then, the use of fluoropolymer PPAs has become widespread in polyolefins; resin manufacturers often add it to their polymer resins as part of an additive package. It is conjectured that fluoropolymer additives migrate to the die surface where they lower the surface energy, allowing the polyolefin to slip at the wall.

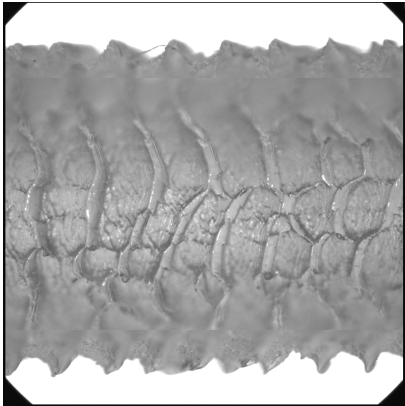

The sharkskin instability produces a surface roughness that limits the manufacturing rate in numerous applications.

However, the study of polymer process additives is made difficult for two reasons. First, there are no available in-situ measurement tools. Thus, it is difficult to know whether a given additive migrates to the surface, and if so, does it induce slippage? Second, at a fundamental level the cause of sharkskin and the precise reason that fluoropolymer additives reduce it are still under debate. This lack of understanding of the mechanism makes it conceptually difficult to rationally design new materials. These difficulties then spill over into other areas such as manufacturing efficiency, development of new metallocene based polyolefins and expanding the usability of PPAs into new markets.

Using the NIST extrusion visualization facility, we have made substantial progress in addressing the shortcomings of the traditional techniques. We utilize stroboscopic optical microscopy to visualize the polyethylene-fluoropolymer system as they are extruded through a transparent circular capillary die. In the close-up photograph of the capillary apparatus (below), the bright cube in the center surrounds a capillary tube that is held in place by the steel gland fittings behind it. This capillary apparatus is situated at the exit of a Haake torque rheometer with a co-rotating twin screw extruder attachment. The extruder melts, mixes, and then pumps the polymer through the capillary die. The molten extrudate strand is seen exiting the sapphire tube and traveling to the bottom right of the photograph. The microscope objective lens is below the bright cube.



The extrusion visualization facility provided the critical tool to determine the cause of sharkskin in polyethylene.

Using the NIST extrusion visualization facility, we have made the following measurements that are relevant to the sharkskin and PPA problem:

- Local shear rate
- Extensional shear rate
- Coating kinetics
- Wall slip and polymer-polymer slippage

We were the first to directly visualize the fluoropolymer as it coats the capillary wall upon addition of the PPA to the host polymer. In the following sequence, we first extrude the pure host polymer. Next, we extrude the host polymer plus the PPA at a mass fraction of 0.1%. The fluoropolymer coats the surface in a stripe pattern which is difficult to discern at first but becomes sharper with time (see video micro-graph below). The formation of this structure at the surface coincides with the disappearance of sharkskin from the extrudate.

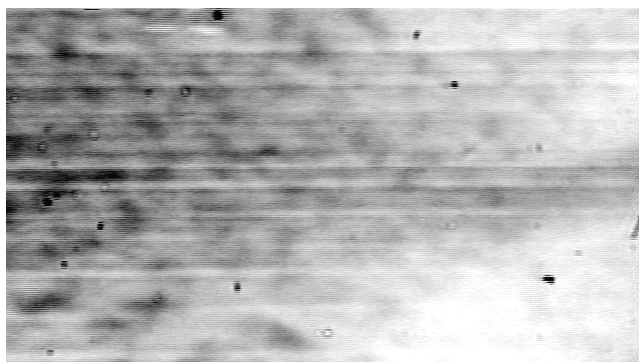

Understanding the structure of the fluoropolymer as it coats the internal die surface may lead to new additive formulations and processing strategies.

A second contribution that the extrusion visualization facility makes to the study of sharkskin and PPA is in measurement of the change in velocity profile of the polymer as it travels through the tube. The presence of the PPA has a dramatic effect on this velocity profile. Before the PPA was added, the polymer obeyed what is known as the “stick boundary condition.” The figure at the bottom-right shows the velocity of the polymer from the center of a cylindrical tube “depth = 0” to the outer wall “depth = 0.8 mm.” The velocity of the polymer goes to zero at the capillary wall. In the absence of any PPA (red curve) the velocity is a maximum at the center and decreases to zero at the wall.

In the presence of the PPA, the polymer velocity remains finite at the wall. Note the existence of two discontinuous blue points at the wall. The upper one corresponds to the LLDPE and the lower one corresponds to the PPA. This is the first direct evidence of polymer-polymer slippage.

Flow velocimetry in the presence of the PPA then shows that slip occurs for all throughputs. This slip is observed to occur at the interface between the two polymers. The magnitude of the slip extrapolation length ($\approx 200 \mu\text{m}$) indicates that these two polymers are fully disentangled.

The capillary rheo-optics methodology is shown to be an important complement to traditional capillary rheology. By providing both flow velocimetry and high speed imaging, a coherent picture of the suppression of sharkskin by use of fluoropolymer PPAs emerges. In the absence of the PPA, we confirm that slip in the die is not observed and thus is not a necessary ingredient for sharkskin. Upon addition of PPA, we observe the coating process through direct imaging. We see that the PPA forms elongated structures in the flow direction. The formation of the PPA layer coincides with the disappearance of the sharkskin in the extrudate.

These results are impacting industry by providing quantitative measurement tools and in-situ screening methods for understanding how PPAs reduce sharkskin. Future work will concern the mechanism by which sharkskin occurs, measurements of slippage, and an attempt to understand why different polymers behave so differently with respect to sharkskin formation.

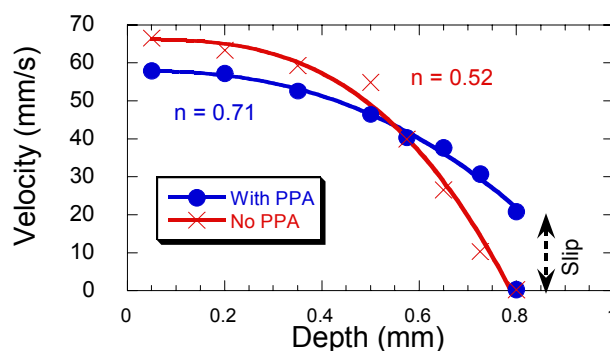

Direct velocimetry experiments are replacing rheological measurements that are laborious and contain inherent uncertainties.

For More Information Kalman B. Migler

On This Topic

Polymer Reference Materials for Calibration of Instruments and for Benchmarking

Standard reference materials and reference materials are issued to address needs of the producers, processors and users of polymers for calibration and for performance evaluation of instruments used in the control of the synthesis and processing of polymers as well as benchmarks for comparisons of measurement methods and development of new materials. Recently produced standard reference materials include polyethylene of narrow mass distribution certified for mass average molecular mass and intrinsic viscosity and a nonlinear fluid standard for rheological measurements. In addition, the first reference biomaterial, an orthopedic grade ultrahigh molecular weight polyethylene, was issued for use in development of improved test methods for wear and as a benchmark for development of improved materials.

New Polyethylene Molecular Mass Standards

Three new polyethylene standard reference materials were certified for mass average molecular mass by light scattering and intrinsic viscosity in 1,2,4 trichlorobenzene. The three narrow mass fractions, $M_w/M_n=1.2$, together with the three narrow fraction polyethylene standard reference materials that NIST already provides, make a total of six narrow fraction polyethylene SRMs certified for molecular mass averages. The mass standards cover the mass range from 6000 u to 200,000 u. The polymer industry, analytical laboratories and university researchers use these unique standards primarily for calibration of gel permeation chromatographs, the principal instrument used for determination of the mass distribution of polymers. The figure displays the chromatograms of these six standards. The starting materials for all six of these standards were produced by fractionation of a whole linear polyethylene that is also available from NIST, SRM 1475.

Polyethylene is the dominant commercial polymer in the United States and worldwide markets. High temperature (130 °C) size exclusion chromatography (SEC), although a relative method requiring calibration, is the most commonly used method to establish the molecular mass of these polymers. Yet, few SEC calibration standards are commercially available for calibration of high temperature SEC. Molecular mass fractions of low polydispersity, M_w/M_n , of less than 1.2 (M_w is the mass average molecular mass and M_n is the number average molecular mass), are the most useful materials for calibrating SEC. The NIST polyethylene standard reference materials, SRMs, are the only available narrow fractions of polyethylene. Prior to the availability of these standards, crude approximations had to be used in the calibration of gel permeation chromatographs for mass distribution measurements.

Non-linear Fluid Standard for Rheological Measurements

Non-Newtonian rheological standards are developed to exhibit the typical polymeric behaviors of shear thinning and normal stresses; these standards are also used for calibration of rheological instruments and for research into improved measurement methods.

Polymer fluids, such as polymer melts and solutions, often do

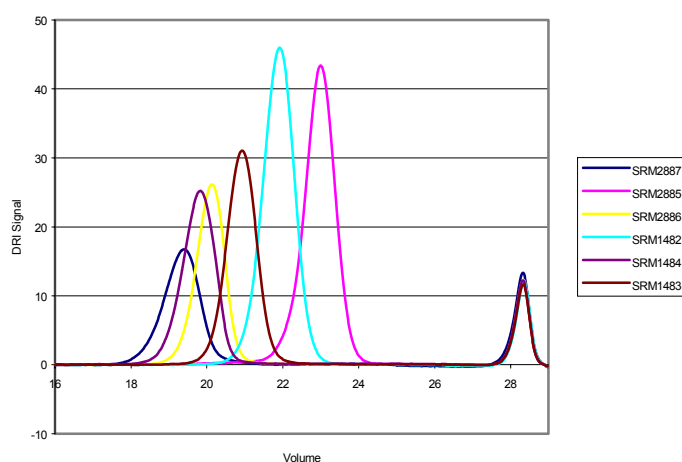

Virtually all U.S. manufacturers of polyethylene purchase NIST molecular mass standards for measurement assurance.

not follow the simple Newtonian ideal in their flow behavior, demonstrating shear-rate dependent viscosities and normal stresses. Such fluids see wide application in everyday life (injection molding, paints and coatings, food products, etc.), and the ability to measure and characterize their behavior accurately is very important to optimizing their processing conditions. Since there are a number of commonly used methods to measure the flow behavior of polymers, the new Standard Reference Material (SRM 2490) will provide a way for comparing the performance of different instruments, as well as providing tools for research into better methods of measuring the rheological properties of polymeric fluids. SRM 2490 is certified for the shear-rate dependence of viscosity and first normal stress difference at temperatures of 0 °C, 25 °C and 50 °C. The linear viscoelastic responses are also certified, along with the temperature dependence of the shift factors. The new polymer solution, SRM 2490, supercedes the previous SRM 1490 Nonlinear Fluid Standard, which was composed of a high-molecular mass polyisobutylene dissolved in normal hexadecane. This standard fluid was found to have two problems: first, it showed evidence of loss of homogeneity on storage, and

second, the working range of the fluid was limited by the crystallization of the normal hexadecane, which has a melting point of 18 °C (64 °F). SRM 2490, on the other hand, consists of polyisobutylene (molecular mass of approximately 10⁶ g/mol) dissolved in 2,6,10,14-tetramethylpentadecane. This solvent is a branched alkane of a slightly higher molecular mass than normal hexadecane; the branching prevents crystallization or vitrification down to at least -60 °C, and the higher molecular mass reduces the rate of evaporation as compared to normal hexadecane. SRM 2490 will be used in an interlaboratory comparison involving over 20 laboratories, representing instrument manufacturers and users in industry and at universities. The interlaboratory comparison will provide information regarding the laboratory-to-laboratory variability in the measurements; the variability in the measurement of the first normal stress difference is of particular interest.

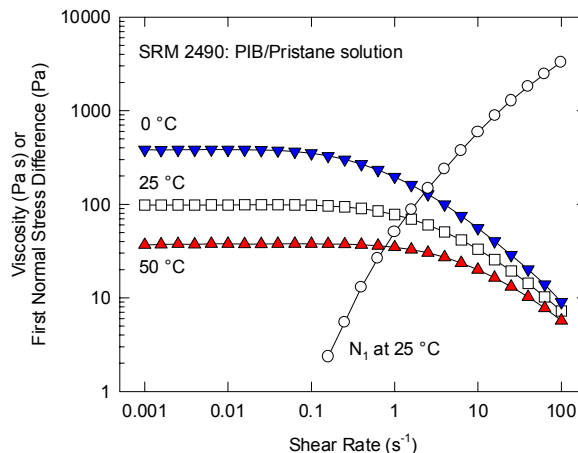

Twenty laboratories representing instrument manufacturers and users will join in an interlaboratory comparison using the NIST Nonlinear Fluid Standard.

Reference Biomaterial for Orthopedic Research

Reference Material (RM) 8456, an orthopedic grade Ultra High Molecular Weight Polyethylene (UHMWPE), became available in October 2000. RM 8456 is intended primarily for use in mechanical characterization of material properties and laboratory-simulated performance of orthopedic joint replacement implants. The availability of this reference polyethylene is expected to aid in development of improved test methods and materials by providing a benchmark for comparisons. The need for this reference biomaterial was identified at a workshop on reference biomaterials held at NIST and its development was the result of collaboration among a materials supplier, the orthopedic research community and NIST.

The material used to prepare RM 8456 was donated by Poly Hi Solidur, Inc., MediTECH Division, Fort Wayne, IN in a form similar to that from which many orthopedic components are machined: a cylindrical bar with nominal dimensions of 7.62 cm (3 in) in diameter. Reference properties, reported as mean values with their expanded uncertainties, are Young's modulus, tensile yield strength, tensile ultimate strength, and tensile elongation-to-failure. These properties characterize the bar across the center 5.62 cm (2.21 in) of its diameter and down the entire bar length. Material beyond the central 5.62 cm was found to differ significantly from that within.



The NIST Orthopedics Research Consortium, whose member companies manufacture 80% of orthopedic total joint replacement products sold in the U.S., developed a new wear testing apparatus for accelerated screening of new materials without compromising the basic wear mechanisms that take place in the human body.

For More Information

On This Topic

- Charles Guttman – Polymer molecular mass standards
- Carl Schultheisz – Nonlinear fluid standard
- John Task – Reference biomaterials

Certification of the Relative Molecular Mass and the Limiting Viscosity of SRM 2885-7, NISTIR 6454, 6456, 6487.

Standard Reference Materials: Non-Newtonian Fluids for Rheological Measurements, Proc. SPE ANTEC, Vol. 1, pp. 1042-1046, Orlando, FL, January 5, 2000.

Biomaterials FORUM, Vol.22, #6, Nov-Dec, 2000.

Nitric Acid-Modified N-Phenyliminodiacetic Acid – A Total Self-etching Primer for Bonding to Tooth Structure

Dental manufacturers and practicing dentists need stable, simplified, self-etching primers that will simultaneously condition both dentin and enamel surfaces and also mediate effective bonding to these mineralized tissues. Such self-etching primers will overcome many of the problems of current dental adhesives, promote conservative dentistry and benefit the general public.

Current dental adhesives systems are characterized by the complexity of their compositions and bonding procedures. Bonding protocols for applying a variety of adhesive agents often are technique sensitive, labor intensive and multi-step in nature. In order to cleanse debris (smear layer) from the surfaces of prepared teeth and condition these substrates to accept adhesive agents, many dental adhesive systems use strongly acidic etchants, e.g., aqueous phosphoric acid. These aggressive conditioners have a propensity to over-etch mineralized tissues, especially dentin which is not as highly mineralized as enamel and, consequently, lacks the superior buffering capacity of the latter. Many bonding protocols require rinsing and drying of the conditioned surface.

Conditioning dentin with strong acids removes the smear layer, demineralizes peritubular and intertubular dentin and creates a micro-porous surface into which adhesive agents can diffuse. However, these conditioners have the potential of also damaging subsurface dentin and reducing the strength and/or durability of the adhesive interface.

Recent studies at NIST have shown that N-phenyliminodiacetic acid (PIDAA), a unique imino diacid of moderate acidity (pH=2.5) with excellent chelation potential for calcium, can be used as a dentin conditioner. Not only does PIDAA remove the smear layer and create a micro-porous surface without excessive demineralization or the need for aqueous rinsing, it also has the ability to prime the surface for effective interfacial polymerization. Thus, PIDAA combines several functions in one adhesive agent: substrate conditioning for infiltration and surface activation for polymerization. Several, simplified, two-step dentin bonding systems based on PIDAA have been developed. However, there is a need for a self-etching primer that is effective not only with dentin but also with enamel, that is a “total” self-etching primer. PIDAA itself is only marginally effective as a self-etching primer for enamel. In a recently completed study we have shown that the addition of small quantities of strong acids such as nitric acid to PIDAA solutions results in effective “total” self-etching primers. SEM analysis of enamel treated with PIDAA primers showed that effective surface etching occurred (See Figures 1 and 2).

For assessing shear bond strength to bovine enamel and human dentin, a two-step bonding protocol was used:

1) aqueous acetone (1:1 by mass ratio) solutions of PIDAA (6.4 %) and nitric acid (NA) at two concentrations (2.5 % or 1.25 %) were applied to either bovine enamel or human dentin surfaces for either 30 s or 60 s, rinsed with distilled H₂O and air dried. 2) Five coats of 20 % photoactivated PMGDM (a carboxylic acid containing monomer, pyromellitic glycerol dimethacrylate) in acetone, were then applied and light cured 20 s prior to placement of a photocurable composite (irradiation time=60 s). All % values represent mass fractions.

Shear Bond Strength (SBS) and Standard Deviation in MPa to Tooth Structure

• Bovine Enamel

Self-etching Primer	Time (s)	SBS (SD)
PIDAA + 1.25 % NA	60	27.9 (9.6)
PIDAA + 1.25 % NA	30	27.3 (8.5)
PIDAA + 2.5 % NA	60	32.8 (6.1)
PIDAA + 2.5 % NA	30	28.0 (6.5)

• Human Dentin

Self-etching Primer	Time (s)	SBS (SD)
PIDAA (Control)	60	24.7 (8.4)
PIDAA (Control)	30	24.6 (6.5)
PIDAA + 1.25 % NA	60	28.1 (7.0)
PIDAA + 1.25 % NA	30	27.3 (11.1)

A two-way ANOVA ($\alpha=0.05$) indicated that there was no statistically significant interaction between application time and NA concentration ($p=0.4$ for enamel and $p=0.74$ for dentin).

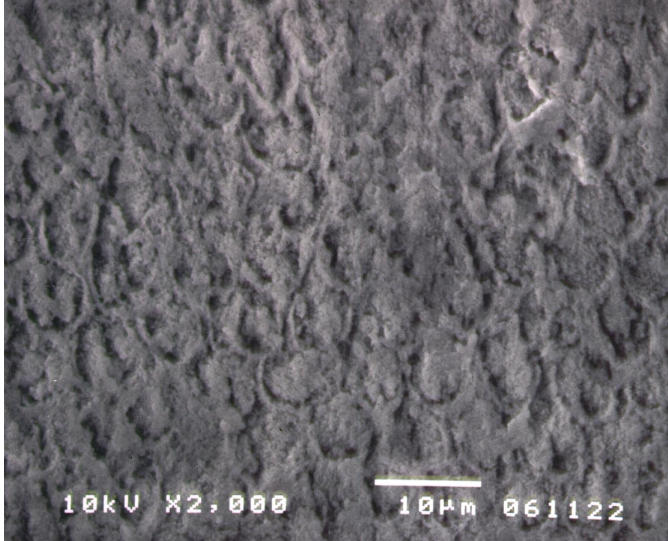

Fig. 1. Enamel surface after a 30 s application of 2.5 % HNO₃ in 6.4 % PIDAA acetone/H₂O solution. Note: selective demineralization to expose the microstructure of the enamel prisms.

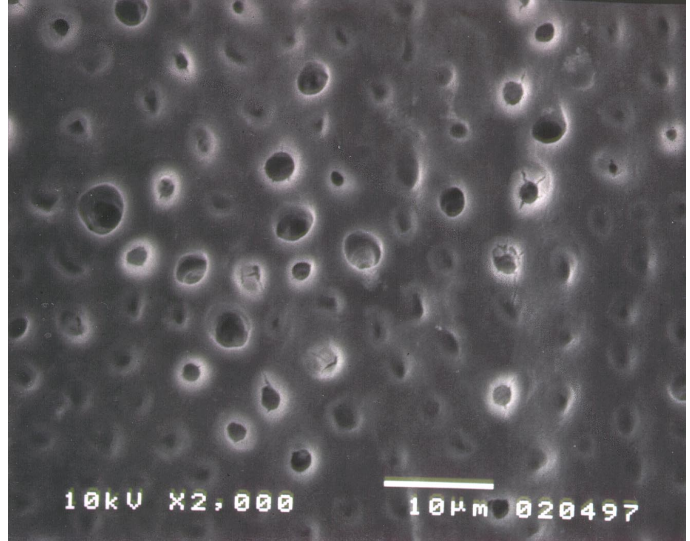

Fig. 2. Dentin surface after a 30 s application of 2.5 % HNO₃ in 6.4 % PIDAA acetone/H₂O solution. Note: the smear layer is demineralized and the dentinal tubule orifices are exposed.

Simplified dental bonding systems, equally effective on both dentin and enamel, are feasible with certain acid-modified PIDAA solutions. We now have developed a self-etching primer applicable to both dentin and enamel by adding small amounts of stronger acids such as nitric acid to PIDAA. The resultant bond strengths of composite to enamel and/or dentin were virtually equivalent. A joint patent application with the American Dental Association Health Foundation (ADAHF) has been filed covering this technology. Previous relevant NIST patents have been licensed by ADAHF and sublicensed by Caulk/Dentsply.

For More Information

Antonucci JM, Bennett PA; Method and Composition for Promoting Improved Adhesion to Substrates. U.S. Patent 5,498,643, March 12, 1996; U.S. Patent 5,690,840, November 25, 1997; U.S. Patent 5,756,560, May 26, 1998.

On This Topic

Joseph M. Antonucci, Frederick C. Eichmiller and Gary E. Schumacher

Combinatorial Measurements of Phase Separation and Dewetting in Polymer Films

An understanding of the stability and homogeneity of thin polymer films on solid substrates has technological and scientific importance in applications ranging from coatings, dielectric layers, and lubricant surfaces to fundamental studies of polymer thin films. Dewetting and phase separation are two important and commonly occurring phenomena that can be used to control the morphology, topography and chemical composition heterogeneity of polymeric surfaces. These phenomena are influenced by a large number of factors that include both material properties as well as process variables, leading to a multidimensional parameter space that is difficult to explore by conventional experimental and analysis methods. The power of combinatorial methods for mapping out phase separation and dewetting in polymer thin films is demonstrated here.

Introduction

Due to successes in pharmaceuticals research, combinatorial and high-throughput methods for searching composition space have received increasing attention for the synthesis and discovery of new inorganic materials, catalysts, and organic polymers. Combinatorial methods can also allow rapid scanning of parameter space to make fundamental measurements and develop physical models for polymers. One limitation is the difficulty of preparing parallel libraries and performing high-throughput screening with conventional instrumentation and sample preparation techniques.

We present combinatorial methods for measuring two important fundamental properties of polymer thin films: dewetting and phase behavior of blends. In each case library creation, high-throughput measurements, and informatics are used to generate combinatorial maps of wettability and phase behavior. The temperature and film thickness dependence of the dewetting behavior of polystyrene on silicon is evaluated in combinatorial libraries in which thickness and temperature are varied systematically. Automated scanning optical microscopy is used to determine the time-temperature-thickness superposition of dewetting kinetics and to observe transitions between film stability regimes. By a similar methodology, the phase boundary for a polystyrene / poly(vinylmethyl ether) blend film is observed with composition-temperature libraries. The combinatorial method is validated by comparison to previous results. In this procedure, the wafers are cleaned in a Piranha solution to grow a thin ($\approx 10 \text{ \AA}$) layer consisting primarily of SiO_x. The results show that high-throughput experimentation is useful not only for the discovery of new materials, but also for observation of fundamental materials properties.

Experimental

Library Creation. To investigate polymer thin film dewetting phenomena, we used sample libraries with orthogonal gradients in thickness (h) and temperature (T) to create a large database of dewetting information in a few hours of experiments. Thickness gradients were prepared on "Piranha-etched" silicon wafers (Polishing Corporation of America) with a velocity-gradient, knife-edge coating apparatus. A drop of polymer solution was spread over the

substrate under an angled steel blade (5 degrees relative to substrate) at constant acceleration. The solvent dried within seconds of spreading, and resulted in a polymer film with a gradient in thickness. The initial and final thicknesses and the slope of the gradient were controlled with solution concentration, blade-substrate gap width, and spreading velocity and acceleration. The thickness profiles, measured with 0.5 mm diameter spot-ellipsometry, had power law or polynomial dependence on position on the wafer, depending on the flow conditions. Solutions with mass fractions of 2% and 5% polystyrene (Goodyear, $M_w = 1900 \text{ g/mol}$, $M_w/M_n = 1.19$, where M_w and M_n are the mass and number average relative molecular masses) in toluene were used to prepare 25 mm wide sample wafers.

Our high-throughput method for studying polymer blend phase separation involves the creation of libraries with orthogonal gradients in blend composition and temperature. Three steps are involved in preparing composition gradient films: gradient mixing, deposition, and film spreading. Two syringe pumps introduce and withdraw polymer solutions to and from a mixing vial at rates I and W , respectively, where $I = W = 1.7 \text{ mL/min}$. Pump I contained mass fraction PS = 0.080 of polystyrene (PS, $M_w = 96.4 \text{ kg/mol}$, $M_w / M_n = 1.01$, Tosoh) in toluene. The vial was loaded with an initial 2.0 mL of mass fraction 0.080 of poly(vinylmethyl ether) (PVME, $M_w = 119 \text{ kg/mol}$, $M_w/M_n = 2.5$) in toluene from pump W . The infusion and withdrawal syringe pumps were started simultaneously while vigorously stirring the vial solution, and a third syringe, S , was used to manually extract solution from the vial. The rates I , W and S , the initial volume in the vial, and the sampling time control the end points and slope of the composition gradient, which has been verified in situ with FTIR spectroscopy.

Next the gradient solution from the sample syringe is deposited as a thin 31 mm long stripe on the silicon substrate. The gradient stripe was quickly placed under a stationary knife edge of equal length. The gradient stripe was spread as a film, orthogonal to the composition gradient direction, for a distance of 40 mm with the flow coating procedure described above. After a few seconds most of the solvent evaporated, leaving behind a thin film with a gradient of polymer composition.

High Throughput Screening

Both the thickness (dewetting) and composition (phase behavior) gradient samples were annealed on a linear T gradient heating stage, over a large range of T values, $90\text{ }^{\circ}\text{C} < T < 160\text{ }^{\circ}\text{C}$. A CCD camera (Kodak ES1.0) coupled to an optical microscope (Nikon Optiphot 2) sent (1024 x 1024) pixel, 8 bit digitized images to a computer that also synchronized sample stage movement over a grid of T and h conditions using a robotic x,y translation stage. For quantitative analysis of images, we averaged the library T and h values over the image area. At the beginning of each time cycle, the translation stage returned to a home position to within $\pm 0.5\text{ }\mu\text{m}$. In a typical experiment, the T-h-t dependence of dewetting structures was followed by collecting a 5 by 5 array of images every 5 min over a period of 2 h, for a total of 600 images. Optical microscope images and photographs capture the phase separation process as a function of T and ϕ_{PS} with average standard uncertainties of $T = \pm 1.5\text{ }^{\circ}\text{C}$ and $\phi_{\text{PS}} = \pm 0.006$.

Results and Discussion

Figure 1 presents a photograph of a typical temperature-composition library after 2 h of annealing, in which the LCST phase boundary can be seen with the unaided eye as a diffuse curve. Cloud points measured with conventional light scattering are shown as discrete data points and agree well with the phase boundary observed on the library. The diffuse nature of the phase boundary reflects the natural dependence of the microstructure evolution rate on temperature and composition. Near the LCST boundary the microstructure size gradually approaches optical resolution limits (1 μm), giving the curve its diffuse appearance.

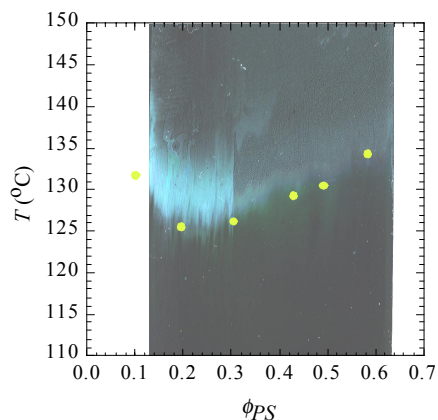

Figure 1. Photograph of a combinatorial library showing LCST phase boundary for PS-PVME with validating data from conventional scattering cloud points.

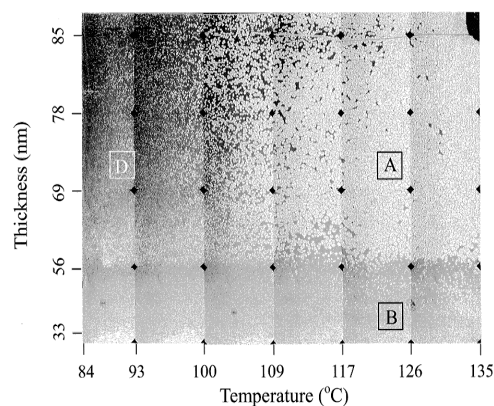

Figure 2. Composite image of overlapping optical micrographs (one square image is 6 mm on a side) of a temperature-thickness library used to study thin film dewetting. Bright regions are more dewet than dark regions. A wide range of structures (holes [D] and polygons [A]) and both metastable and unstable (capillary nucleated [B]) film regions are observed in this image.

By using a combinatorial technique to prepare libraries in which the temperature and thickness are varied systematically and continuously, we have also measured the temperature-thickness-time dependence of dewetting structures, stability, and kinetics in a small number of experiments. Figure 2 presents a composite optical image of a typical T-h library that indicates different dewetted structures and growth rates as a function of T and h. The libraries are able to reproduce a wide range of dewetted structures observed with our own uniform control samples and in previous work of others for similar systems, validating our methodology. The method presented here is unique in its ability to rapidly identify fundamental trends in film stability, nucleation mechanisms, and dewetting kinetics over a wide range of parameter space. Delineating these effects early in a scientific study can lead to observations of novel regions of phase space for thin film phenomena and can be extremely useful in guiding detailed analysis with conventional one-sample for one-measurement approaches.

For More Information

J.C. Meredith, A. Karim, E.J. Amis, *Macromolecules*, **33**, 5760 (2000).

On This Topic

Alamgir Karim and Eric Amis

Structure and Property Measurements of Porous Low-k Dielectric Thin Films

Low-k interlayer dielectric materials have been identified by the microelectronics industry as a critical factor to enable deep submicron technology for the continued improvement of integrated circuits. NIST is working to provide the semiconductor industry with unique on-wafer measurements of the physical and structural properties of porous thin films important to their use as low-k dielectric materials. We have developed a novel methodology utilizing several complementary experimental techniques to measure the average pore size, porosity, pore connectivity, film thickness, matrix material density, coefficient of thermal expansion, moisture uptake, and film composition of several classes of candidate porous thin film materials.

As integrated circuit feature sizes continue to shrink, new low-k interlayer dielectric materials are needed to address problems with power consumption, signal propagation delays, and crosstalk between interconnects. One avenue to low-k dielectric materials is the introduction of nanometer scale pores into a solid film to lower its effective dielectric constant. However, the pore structure of these low-k dielectric materials strongly affects important material properties other than the dielectric constant such as mechanical strength, moisture uptake, coefficient of thermal expansion, and adhesion to different substrates. The characterization of the pore structure is needed by materials engineers to help optimize and develop future low-k materials and processes. Currently, there is no clear consensus among IC chip manufacturers for the selection of a class of material or a processing method of nanoporous films. Candidates include silica-based films, organic polymers, inorganic spin-on materials, chemical vapor deposited materials, and several others. With the large number of possible materials and processes, there is a strong need for high quality structural data to help understand correlations between processing conditions and the resulting physical properties.

The characterization of the pore structure of thin nanoporous low-k dielectric films is not straightforward. The small sample volume of 1 μm films and the desire to characterize the film structure on silicon wafers narrows the number of available measurement methods. We have developed a novel combination of small angle neutron scattering (SANS), high-resolution x-ray reflectivity (HRXR), and ion scattering techniques to determine important structural and physical property information about thin porous films less than 1 μm thick. These measurements are performed directly on films supported on silicon substrates so that processing effects can be investigated. HRXR is used to accurately measure the film thickness, the average film electron density, and the coefficient of thermal expansion. SANS is used to determine the pore structure, providing information such as the average pore size, pore connectivity, and moisture absorption. Ion scattering techniques are used to determine the elemental composition of the films.

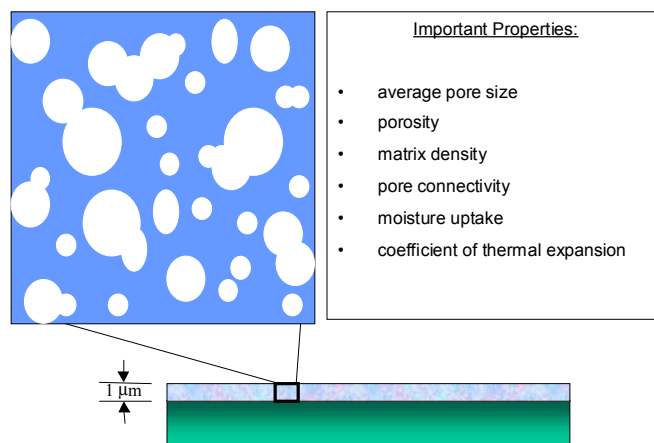

Schematic diagram of a porous thin film structure for low-k dielectric material.

By combining information from all three of these techniques, we provided the first independent measurements of important quantities such as the film porosity and the pore wall density. By measuring the properties of a wide range of materials and processing conditions, the U.S. microelectronics industry is assisted in development of the proper materials and processing conditions for low-k dielectrics needed for the commercial production of next generation integrated circuits.

During the past year, measurement efforts have been focused into three areas, characterizing current industrially relevant materials through International SEMATECH, gaining fundamental understanding of different classes of material preparation, and conducting an international round robin comparison of different on-wafer measurement techniques. International SEMATECH, a consortium of microelectronics companies, has provided more than 25 separate samples for characterization by NIST including spin-on glass materials, films from chemical vapor deposition, and organic thin films. The structural information provided by NIST is placed into a master database, combining data from a variety of sources, detailing both the structural and material properties needed to evaluate candidate materials. The data have been extensively used by member companies to guide the development of low-k dielectric materials for integration into future devices.



Photograph of the interior of the NIST high-resolution x-ray reflectometer with a silicon wafer with a low-k dielectric thin film.

Additionally, we have collaborated with several groups to provide measurements to better understand fundamental scientific issues in general classes of sample processing methods. With Dow Corning Corporation, our measurement methodology was used to better understand the effect of cosolvent concentration on the film structure using a two-phase processing method based upon sol-gel techniques. With Sandia National Laboratories and the University of New Mexico, our methodology was applied to characterize the pore uniformity, average pore size, and matrix material density variations in porous silica thin films using surfactant templates. With Lucent Technologies, our methodology was used to determine the structure of porous thin films prepared using a novel polymer porogen approach. The pore structure was measured as a function of processing temperature, polymer loading concentration, and polymer architecture. By directly correlating the resulting film structure with controlled variation of processing variables, we help provide the fundamental understanding needed to improve these fabrication methods.

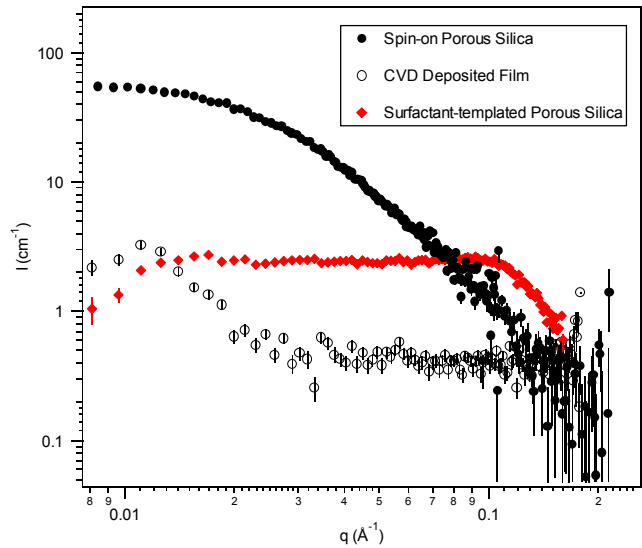

Representative small angle neutron scattering data from three different types of porous low-k dielectric thin films.

Finally, we have established an international collaboration including private, government, university, and corporate research groups from NIST, IMEC (Europe), the Institute of Semiconductor Physics (Novosibirsk), the University of Michigan-Ann Arbor, the Kyushu Institute of Technology, CCIC, Ltd. in Japan, and Dow Corning Corporation to critically compare data from several different on-wafer measurement methods for the structure of porous thin films. The techniques, including the NIST methodology, ellipsometric porosimetry, and positron annihilation lifetime spectroscopy, are used to determine average pore size, film porosity, pore connectivity, pore wall density, and the pore size distribution. Each measurement method determines the film structure differently and provides complementary information. It is expected that the results from this collaboration will provide a needed overview and practical guidelines for researchers to rigorously characterize the structure of porous low-k dielectrics. The broad scope of this collaboration also provides extremely valuable information to the microelectronics industry for the selection of appropriate characterization methods to optimize measurement turnover rates and quality of data.

For More Information

On This Topic

E. K. Lin, W.L. Wu, C. Jin and J. T. Wetzel, "Structure and Property Characterization of Porous Low-k Dielectric Constant Thin Films Using X-ray Reflectivity and Small Angle Neutron Scattering," Mat. Res. Soc. Proc., San Francisco, CA, 2000, in press.

Eric K. Lin, Barry J. Bauer, Wen-li Wu

Polymer composite dielectrics enable development of embedded decoupling capacitance technology for high speed electronics

Increased signal speed within electronic circuits can be achieved by creating an efficient local power supply for charging fast processors and switching devices. Current technologies utilize surface mount discrete capacitors, which become ineffective at frequencies approaching 1 GHz. Our effort focused on embedded capacitance layers made of polymer composite films to effectively eliminate the switching noise. We have developed a specialized test vehicle design and invented a new testing procedure to verify the efficiency of embedded capacitance on circuit boards and to measure the broad-band dielectric permittivity of new materials at functional frequencies from 100 MHz to 10 GHz.

High dielectric constant polymer composite materials are being developed by the electronics industry in response to the need for power-ground decoupling to secure integrity of high speed signals and reduce EMI radiated noise. Current technologies utilize surface mounted discrete chip capacitors, which can extinguish the power-bus noise at frequencies below 10 MHz. At higher frequencies, between 10 MHz and 100 MHz, only capacitors with the lowest connection inductance are able to source the charge. As the operating frequency increases above several hundred MHz, all the discrete capacitors become ineffective. In response to these inherent problems NCMS, together with NIST and more than dozen partners, organized a collaborative research consortium aimed at developing and advancing the use of embedded-decoupling-capacitance (EDC) technology. The consortium identified a need to assess the feasibility of this design and to measure the materials dielectric characteristics at frequencies above 1 GHz.

We have developed a specialized test technique to measure the dielectric permittivity of high dielectric constant films in the microwave range using a microstrip test vehicle shown in Fig. 1. The test vehicle comprises a two-layer circuitry and contains a number of microstrip resonators. To improve the accuracy of the measurements, we added to the test pattern appropriate non-coaxial terminations for in-situ calibration. The test pattern is appropriate for testing permittivity in the functional planar configuration of films, 10 μm to 50 μm thick having the dielectric constant ranging from 4 to 40 at frequencies from 100 MHz to 12 GHz. This frequency range is not covered by the existing standard test methods.

The microstrip-resonator technique, which we developed and transferred to the industrial partners, allows for evaluation of permittivity of EDC films at discrete resonant frequencies that do not necessarily overlap with the dielectric relaxation process. In order to address the structural/dielectric attributes in adequate detail, broadband dielectric measurements are needed. However, the existing test procedures for thin films are based on lumped element approximations, which fail to produce meaningful results at microwave frequencies, especially in the case of high-dielectric constant films.

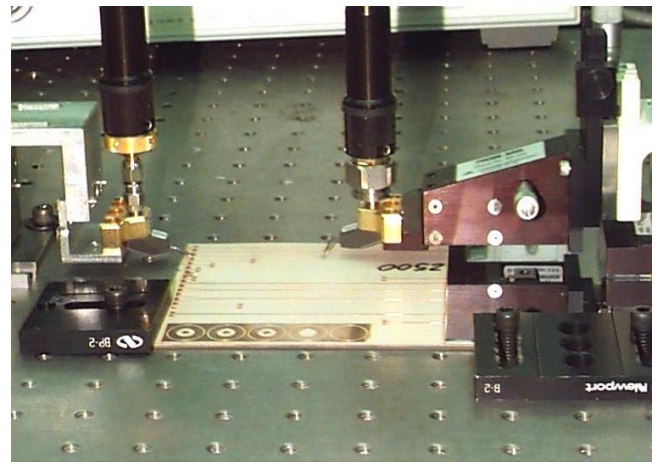

Fig. 1. Permittivity measurements of high-k films using microstrip test vehicle

We have recently achieved a breakthrough in broadband permittivity measurements of dielectric films in coaxial configuration and were able to extend the measurements to frequencies of practical importance, above 1 GHz (Fig. 2.). This has been accomplished by employing an appropriate theoretical model for the wave propagation in the specimen section. Neglecting the propagation, which is the current approach, leads to large systematic errors at microwave frequencies.

We have determined that, contrary to the commonly accepted simplification, the propagation direction takes place along the diameter of the specimen rather than across the thickness of the dielectric.

Furthermore, we found that the limitations of the lumped element method originate from singular behavior at the half-wavelength resonance frequency which is determined by the diameter of the film specimen and its complex permittivity. The experimental permittivity results obtained in the broad frequency range compared very well with the microstrip resonance data at frequencies from 100 MHz to 10 GHz. The thin film configuration does not compromise the dielectric

loss measurements since the propagation length is independent of the specimen thickness.

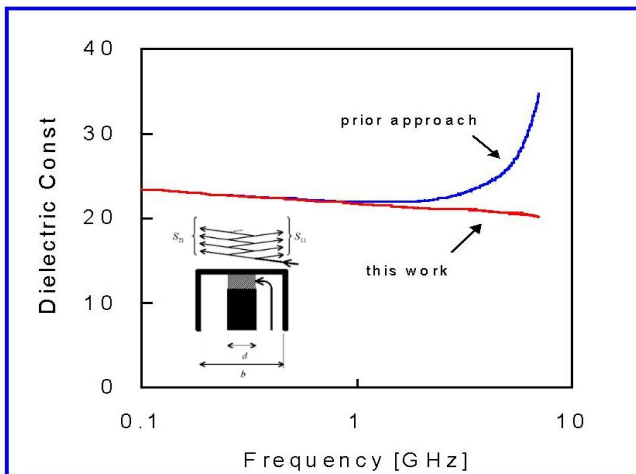

Fig. 2. Broad-band high frequency permittivity measurements of high dielectric constant films – comparison of the NIST developed technique with the prior approach.

To the best of our knowledge, this data analysis scheme has not been successfully implemented before.

We evaluated the microwave dielectric properties of several polymer-ferroelectric ceramic composites newly developed by the industry for EDC applications: BC2000™ and EmCap™ from PolyClad, CPly™ from 3M and HiK™ Polyimide from DuPont. The EDC materials measured in a functional test vehicle configuration showed an exceptionally low and flat impedance characteristic, indicating a much lower Q factor than could be expected from the dielectric properties of the organic and ceramic constituents.

Our study discovered a high frequency relaxation behavior which is intrinsic to binary mixtures of organic polymer resins loaded with ferroelectric powders. We found that the position of the loss peak is determined by the dielectric relaxation of the polymer backbone while its magnitude depends on the dielectric dispersion, and therefore, is amplified by the content and permittivity of the ferroelectric component.

We have recently started developing a new method for broadband impedance characterization of high-k films directly in the time domain. Experiments were conducted in a coaxial configuration to eliminate radiation effects, apparent dispersive behavior, coupling errors and inductive delays. This allowed us to monitor the response to a 12.5 ps rise time voltage step in a 10 ns time window with 2.5 ps resolution. Such resolution and fast responsiveness is essential for the proper evaluation of low impedance circuits. In comparison, other testing configuration that utilize coaxial connectors or coupling probes introduce inductive components that increase the system impedance well above that of measured impedance and therefore, limits the measurement range to slow responses only. It was found that at the time referenced to the incident voltage step V_i (time zero or at highest frequencies) all the EDC specimens appeared as a short circuit indicating a pure capacitive behavior. The best performance, indicated by the response close to that of zero impedance (short) termination, was observed for several industrial test materials. To our knowledge these results represent the most accurate experimental characterization of low impedance planes to date.

We showed that polymer composite films filled with ferroelectric ceramics can provide low impedance through a high capacitance. In addition, such materials can also suppress the undesirable resonant behavior because of their intrinsic high loss. This makes polymer composites films attractive as a broad-band embedded de-coupling capacitance to secure the signal integrity and minimize the EMI noise in high-speed circuits operating at microwave frequencies.

For More Information

On This Topic

J. Obrzut and C. K. Chiang, “ Dielectric measurements of embedded capacitance materials “ Embedded Decoupling Capacitance Project, NCMS Technical Report No.: 091RE00 August 20000, NCMS, 3025 Boardwalk, Ann Arbor, MI 48108. <http://www.ncms.org/index.html>.

J. Obrzut, R. Nozaki

Combinatorial Methods

The Combinatorial Methods Program develops new measurement techniques and experimental strategies needed for rapid acquisition and analysis of physical and chemical data of materials by industrial and research communities. A multi-disciplinary, multi-OU team from the Measurements and Standards Laboratories of NIST participates to address key mission driven objectives in this new field, including assuring needed measurement infrastructure, expanded capability, standards and evaluated data.

Measurement tools and techniques are developed to prepare and characterize materials over a controlled range of physical and chemical properties on a miniaturized scale with high degree of automation and parallelization. Combinatorial approaches are used to validate measurement methods and predictive models when applied to small sample sizes. All aspects of the combinatorial process from sample “library” design and library preparation to high-throughput assay and analysis are integrated through the combinatorial informatics cycle for iterative refinement of measurements. The applicability of combinatorial methods to new materials and research problems is demonstrated to provide scientific credibility for this new R&D paradigm. One anticipated measure of the success of the program would be more efficient output of traditional NIST products of reference materials and data.

Through a set of cross-NIST collaborations in current research areas, we are working to establish the infrastructure that would serve as a basis for a broader effort in combinatorial research. Within MSEL, novel and elegant methods for combinatorial library preparation of polymer coatings have been designed to encompass variations of diverse physical and chemical properties, such as composition, coating thickness, processing temperature, surface texture and patterning. Vast amounts of data are generated in a few hours that help to understand how these variables affect material properties, such as coatings wettability or phase miscibility. Additional focus areas for both organic and inorganic materials include multiphase materials, electronic materials, biomaterials assay, and materials structure and properties characterization. State of the art on-line data analysis tools, process control methodology and data analysis methods are being developed as part of the program.

In order to promote communication and technology transfer with a wide range of industrial partners, an industry-National laboratories-university combinatorial methods center is being organized by MSEL. The consortium will facilitate direct interactions on combinatorial measurement problems of broad industrial interest and efficient transfer of the methods developed to U.S. industry.

Contact Information: Alamgir Karim

Combinatorial Study of Surface Patterns in Thin Block Copolymer Films

Alamgir Karim

Polymeric materials can exhibit marked differences in behavior relative to the bulk when used as thin films and the thickness can greatly affect phenomena such as dewetting, phase separation and ordering on surfaces. To investigate the effect of film thickness on polymer materials expeditiously, a solution flow coater has been developed to produce thin films having continuous gradients in thickness. The flow coater uses a knife-edge suspended above a substrate with a small amount of solution placed under the knife-edge. The substrate is driven at constant acceleration to produce a gradient in film thickness. The film thickness is measured using an automated UV-visible interferometer and a two-dimensional map of the film thickness is obtained. Using this gradient a variety of polymer thin film physical properties can be investigated.

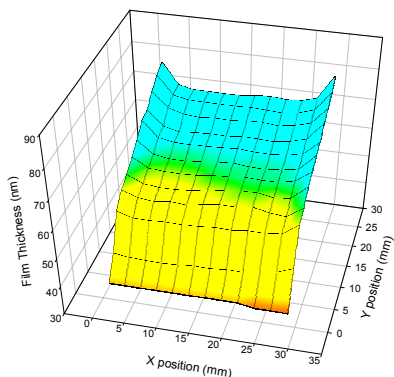

Map showing the change in film thickness for a thin film produced by the flow coater.

To demonstrate the power and utility of such a gradient film approach, the well-studied phenomenon of ordering of symmetric diblock copolymers on surfaces is investigated to validate the high-throughput methodology and to investigate new phenomena revealed by this type of measurement. In thin films of symmetric diblock copolymers, the substrate and air interfaces induce formation of lamella parallel to the surfaces due to the preferential interaction of one of the block components with respective substrate and air surface. It is generally believed that complete lamellae are formed when the total film thickness is equal to an integral multiple of the bulk lamellar thickness, L_0 , and incomplete lamellae

Block copolymers are an important class of polymeric materials with large potential for commercial applications. For instance, their unique properties in melts, blends and solutions leads to their use as adhesives, emulsifying agents, thermoplastic elastomers, compatibilizers, etc. Here we investigate a well studied model block copolymer system using combinatorial methods and demonstrate the power of the method to extract new information and novel phenomena occurring in block copolymer thin films.

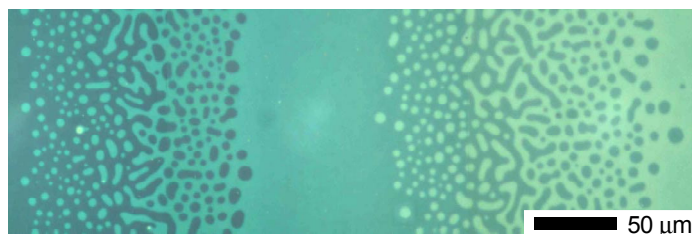

Optical micrograph showing the addition of two lamella to a block copolymer film as the film thickness changes from 81 nm (left) to 117 nm (right).

consisting of holes or islands are formed otherwise. We revisit this problem in substantial detail using the high-throughput approach afforded by the gradient films. The thickness dependence of the morphology is exploited for the experiments here.

Thin film gradients of polystyrene-*b*-poly(methyl methacrylate) were prepared with the flow coater. The morphology observed progresses from smooth regions to islands to co-continuous to holes back to smooth. This trend repeats itself several times with changing film thickness. The island and holes morphologies reproduce those observed previously but the extended smooth regions and the co-continuous areas are novel observations. The entire library was produced in significantly reduced time relative to conventional single thickness samples. The smooth regions are found to accommodate a $0.28 L_0$ change in thickness that was attributed to the increased surface chain density with increasing film thickness and subsequent stretching of the chains. In addition the co-continuous regions are located at $0.41 L_0$ above the smooth regions indicating a preference for hole formation relative to island formation.

The results presented here indicate that the combinatorial methodology can reveal new features even in well-studied problems. The thin film gradient allows for the rapid exploration of parameter space governing thin film properties and enhances the ability to characterize the properties of polymer thin films.

Contributors and Collaborators

Archie P. Smith, Jack F. Douglas, Eric J. Amis, Alamgir Karim (Polymers Division, NIST)
J. Carson Meredith (Georgia Tech)

High-Throughput Measurements of the Film Properties of a Crystalline-Amorphous Polymer Blend

Jack F. Douglas, A. Karim

Many industrial applications require control of the morphology of thin polymer films. Film morphology depends on many factors: method of formation (dipping, evaporation, spin casting), tendency of film components to phase separate or dewet, the crystallization of film components, etc.

Moreover, the morphology is characteristically sensitive to a number of factors (presence of polymer-solid and polymer-air interfaces, topographic and chemical patterns on the solid substrate, filler particles and amphiphilic additives, flow and electric fields, temperature gradients, etc.) that perturb the phase separation of polymer blends or the phase ordering of semi-crystalline polymers. In previous work, we showed that the real space structure of polymer blend phase separation could be studied in considerable detail by forming nearly two-dimensional "symmetric" polymer films in which one of the polymer components segregates to *both* the solid substrate and the polymer-air boundaries. The difference in the surface tension between the blend components causes the film surface to buckle in response to phase separation within the film. This buckling provides a source of contrast in optical and AFM measurements, enabling high-resolution measurements of the dynamics of the ordering process in real space. The phase separation patterns that form in these "ultra-thin" blend films resemble simulated phase separation in two-dimensions and these films thus provide a useful "laboratory" for studying fundamental aspects of bulk phase separation that are difficult to extract from bulk scattering measurements. Ultra-thin polymer films also have special features that derive from the thin film geometry (e.g., surface roughness varies with polymer composition, thickness and temperature) that are crucial for their applications.

While previous studies focused on phase separation in thin films in relation to bulk phase separation, we investigate application-related property measurements in high-throughput manner. Since the parameter space is large (thickness, composition, temperature) we initially investigate each of these variables separately by forming films having a gradient in each variable. First, we prepare films having gradients in thickness that are relatively near-critical

Factors controlling the crystallinity and morphology of semi-crystalline-amorphous polymer blends are important in the design of polymeric materials with tailored properties. There is a need for a greater understanding of the mechanisms controlling the degree of crystallinity in these blends and the influence of crystallization on blend phase separation. We investigate the effect of temperature, composition and film thickness on amorphous/crystalline blend films in a high-throughput manner to determine the interrelations between processing conditions and blend film morphology.

composition so that the phase separation morphology forms a labyrinthine "spinodal" surface pattern. We also manipulate the film morphology through a temperature gradient and determine the phase separation temperature (See figure).

A blend of amorphous and semi-crystalline polymers (poly-methyl methacrylate, PMMA/ polyethylene oxide, PEO) is shown in the figure. We continuously control the steady state pattern size through the variation of the film thickness. The pattern size varies linearly with film thickness in the ultra-thin film regime. The film morphology also changes with the relative polymer composition and these films exhibit features not seen in amorphous-amorphous polymer blends.

Controlling the morphology of thin polymer film coatings allows the film properties (friction, adhesion, optical properties, permeability) to be tuned.

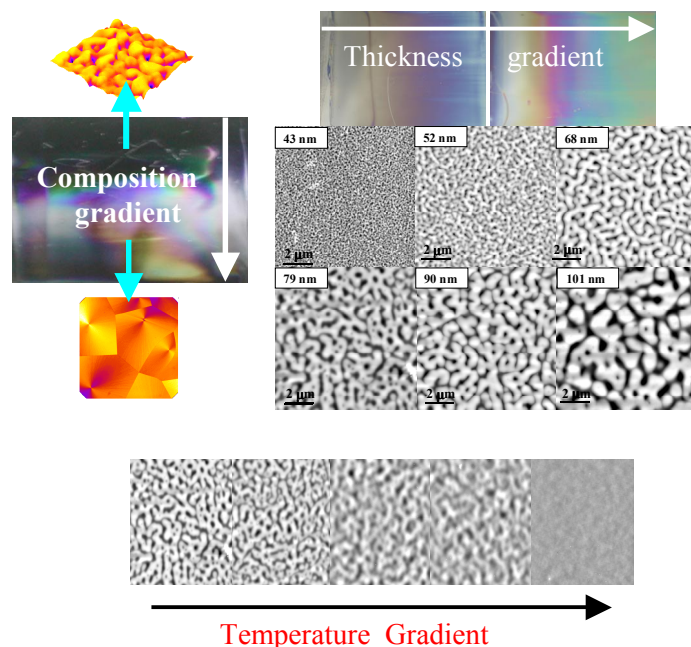

Contributors and Collaborators

V. Ferreiro, J. F. Douglas, E. J. Amis, A. Karim (Polymers Division, NIST)

Pattern Formation in the Crystallization of Polymer Blend Films

Jack Douglas, Alamgir Karim

Polymeric materials often crystallize under non-equilibrium conditions and the optical and mechanical properties of these materials can depend strongly on the resulting crystallization morphology. An understanding of factors influencing crystal structure is then essential to controlling the properties of these materials. We find that an adjustment of the polymer composition in thin blend films allows the polymer crystallization patterns to be tuned through spherulitic, seaweed, symmetric and fractal dendritic forms. These patterns resemble phase field simulations of solidification in alloy mixtures with a variable surface tension anisotropy, ϵ .

A competition between orderly and disorderly growth occurs in a wide range of pattern formation processes such as the growth of cell colonies, electrochemical deposition, etc. To better understand non-equilibrium pattern formation, and polymer crystallization in particular, it is important to have experimental and computational model systems that can be "tuned" through the recognized class of pattern types and to determine the interactions and processes that govern this type of pattern formation.

The observation of general classes of non-equilibrium pattern formation has recently stimulated attempts to explain this "universality". Numerical and theoretical work has established the existence of crystallization "morphology diagrams", analogous to phase diagrams in materials at equilibrium. These theoretical advances provide a rationale for classifying crystallization patterns and insights into the origin of these patterns.

Many recent experimental investigations of a variety of non-equilibrium pattern formation processes involving propagating wavefronts of increased "order" (spherulitic growth in a polymer crystallization context, dense branching or "seaweed" dendritic growth patterns, symmetric dendrite patterns as in snowflakes, and fractal dendritic structures) have also contributed to the developing classification scheme of non-equilibrium crystal growth. Pattern formation in non-equilibrium crystallization is predicted to depend on the degree of undercooling (or supersaturation) and a parameter governing the intensity of the expression of crystalline symmetry in the pattern formation, the surface tension anisotropy, ϵ . However, there have been no quantitative experimental investigations of crystallization in which ϵ is varied to verify the predictions of recent theories of non-equilibrium crystal growth and there is little understanding of factors that influence ϵ .

Polymeric materials have the advantage that the crystallization rate is usually much smaller than metals and small molecule liquids and it is often possible to obtain high supercooling in these materials.

The crystallization of polymers can also accommodate large numbers of defects because of the chain connectivity so that introduction of impurities, defects due to irradiation, and other perturbations may be expected to influence ϵ and thus the gross crystallization morphology.

Polymeric materials are then attractive as model systems for fundamental studies of non-equilibrium crystallization. A blend of a crystalline polymer (polyethylene oxide; PEO) and an amorphous polymer (polymethylmethacrylate; PMMA) was investigated in a thin film geometry. The blend films are sufficiently thin (thickness ≤ 200 nm) for phase separation to occur within the plane of the film. We find that the morphology of these blend films can be *tuned* through a variation of the blend and clay compositions and we compare these measurements to phase field simulations of a model liquid mixture in which the crystallization morphology can be similarly tuned through a range of pattern types.

Experimental Data- PEO/PMMA Blend Film

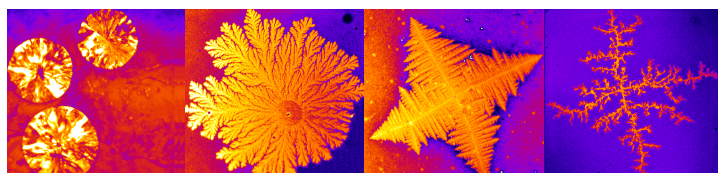

Increasing PEO/PMMA relative mass ratio

Phase-Field Simulation-Alloy Mixture

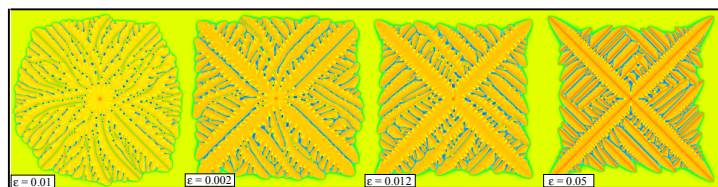

Increasing surface tension anisotropy

Contributors and Collaborators

V. Ferreiro, J. F. Douglas, A. Karim (Polymers Division, NIST)

J. A. Warren (Metallurgy Division, NIST)

Polymeric Templates for Combinatorial Assay of Cellular Reception

Alamgir Karim, Eric J. Amis

Novel high-throughput gradient methods have been developed to generate a range of surface structures by dewetting and phase separation on chemically patterned substrates. The research is motivated by an increasing awareness in the biomedical industry and the tissue culture community that surface interactions are critical in clinically relevant *biocompatible* materials. Surface topography and functionality are two of the key parameters that determine cell adhesion, expression, growth and phenotype. We utilize our knowledge of dewetting and phase separation on patterned substrates to efficiently generate topologically and functionally structured surfaces in a controlled manner. The high level of control is taken further by imposing a discrete step gradient in the pattern dimensions on the substrates that allow us to create a range of surface structures on a single substrate. The combinatoric approach enables us to address cell response in a systematic and realistic fashion.

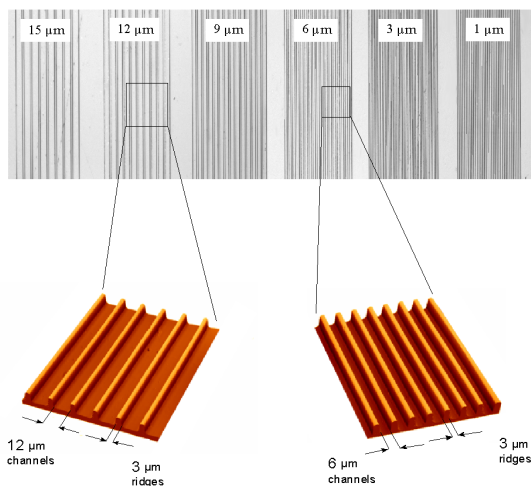

Poly(dimethylsiloxane) PDMS stamp used for soft lithography has 3 μm ridges with channel spacing ranging from 15 μm to 1 μm

The chemically patterned substrates were created by soft lithography, consisting of transfer of alkane-thiols on vapor deposited gold substrates by conformal contact of a poly(dimethylsiloxane) stamp.

Surface structure is a key parameter for cellular response at the bio-interface. The use of polymeric biomaterials in implants and the biomedical industry relies on long-term favorable surface interaction for biocompatibility. We demonstrate the use of self-organization processes of dewetting and phase separation of thin polymer films to generate highly structured substrates that serve as unique polymeric platforms to assay cell growth and function.

Topological surface structure was spontaneously generated by exploiting dewetting of thin polymer films. The surface morphology is sensitive to film thickness, spatial resolution, and the symmetry of the underlying chemical pattern. The step-gradient in the periodicity of the chemical pattern across the surface enables generation of a range of topologies, from structured droplet arrays, to ridges and undulating wave structures. The gradient in surface structure of model polymeric surfaces is being tested for rapid diagnosis of cell expression in a range of topographies.

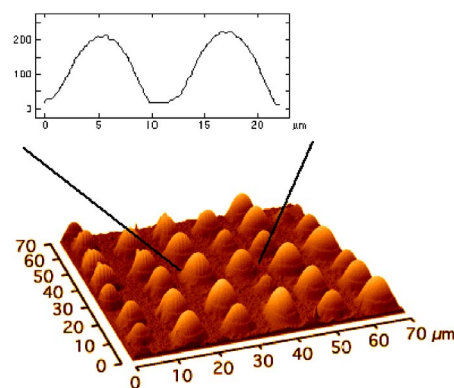

Droplet array of dewet PS on patterned substrate (6 μm).

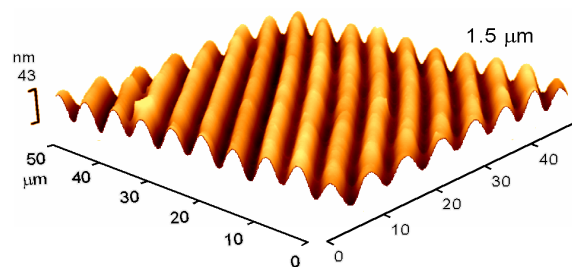

Pattern induced ridged topology in thicker films.

Phase separation of a blend of poly (ϵ -caprolactone) (PCL) and poly (D-lactic acid) (PDLA) on the chemical pattern has also been determined to modulate surface functionality in stripes of hydrophilic and hydrophobic polymer.

Contributors and Collaborators

Amit Sehgal, Alamgir Karim, Jack Douglas, Francis Wang, Carl Simon, Eric J. Amis (Polymers Division, NIST)
Hoda Elgandy, Alessandro Tona (Biotechnology Division, NIST)

Twin-screw Extrusion of Biocompatible Polymers for Tissue Engineering

Newell Washburn, Alamgir Karim

The field of tissue engineering is rapidly growing and there is a need for the development of methodologies to produce polymeric materials with specific properties. These include biocompatibility, mechanical integrity, appropriate surfaces to induce cell attachment, and a continuous porous structure with pores roughly the same size as the cells. The ideal processing technique would be amenable to large-scale production and not require the use of organic solvents that are difficult to remove and lead to cytotoxic responses from host tissue. We have focused on materials for orthopedic applications since this area is of particular current interest.

Twin-screw extrusion is a commonly employed technique used to blend polymers. Two screws rotate in tandem inside a heated metal barrel that subjects the polymers to strong rotational and extensional flows, and leads to a finely mixed blend with domains on the order of a micrometer. The extruded material may be further processed and annealed at higher temperature that leads to coarsening of the domains and an increase in the characteristic length scale of the blend.

In this work, poly(ϵ -caprolactone) (PCL) was blended with poly(ethylene oxide) (PEO) in a mini-compounder. PCL is a biocompatible polyester that has been widely used in biomedical applications and PEO is water soluble and non-toxic. The extruded blend was annealed for 20 min at 80 °C and the PEO was subsequently dissolved, yielding a porous material shown below. This blend had a PEO volume fraction of 0.70 and is mostly void space after dissolution of PEO with water.

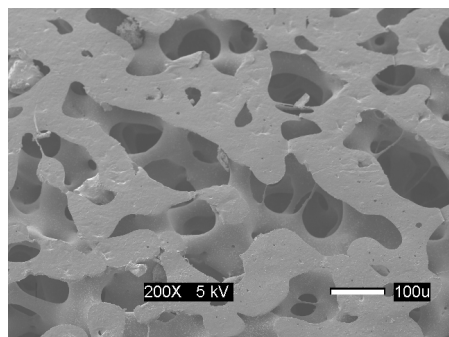

Porous polymeric scaffolds are currently being used in tissue engineering applications. Blending offers unique opportunities for combining biocompatibility of a restricted class of polymers with the mechanical strength of other polymers. We have demonstrated a new methodology for producing such materials using a traditional polymer processing technique, twin-screw extrusion. This method permits control over such important parameters as pore size and connectivity and was demonstrated to yield biocompatible materials.

The pores appear to form a continuous network, which is important for tissue development, and have a characteristic width of approximately 100 μm , which is considered optimal for cell growth.

The mechanical properties were assessed by compression testing. A modulus of 1 MPa was observed at strains below 20 % and a modulus of 10 MPa was observed at higher strains.

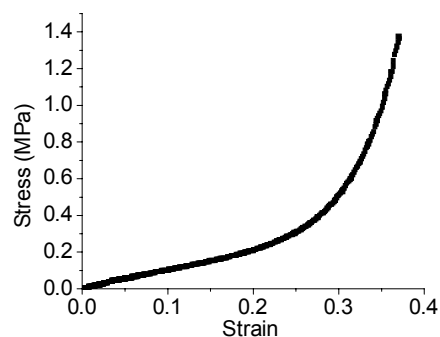

The low-strain modulus is attributed to compression of the scaffold pores while the modulus at higher strains is closer to that of compact PCL. These values are consistent with the performance of scaffolds produced by other techniques.

The biocompatibility of the extruded scaffold was assessed by seeding bone-producing cells, osteoblasts, on the material. The cells (top and right in figure below) appear to spread on the surface, indicating they are viable and the scaffolds are non-toxic.

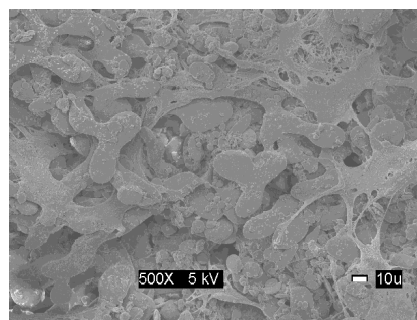

Contributors and Collaborators

Newell Washburn, Carl G. Simon, Jr., Alamgir Karim, Eric J. Amis (Polymers Division, NIST)
Alessandro Tona, Hoda M. Elgendy (Biotechnology Division, NIST)
Kimberlee Potter, Ferenc Horkay (NICHD, NIH)

Polymeric Substrates for Laser Capture Microdissection (LCM)

Alamgir Karim

Laser Capture Microdissection was conceived and developed at the National Institute of Health (NIH) for isolation and extraction of pure populations of target cells from a frozen tissue section. This simple technique facilitates further analysis without contamination from the surrounding tissue. The cells of interest are targeted microscopically through a polymeric transfer surface placed on the tissue. The film comprised of a proprietary ethylene-acrylate copolymer is chosen for its high coefficient of thermal expansion. A brief laser pulse fuses the film at the precise spot and focally adheres with the underlying cell(s) of choice.

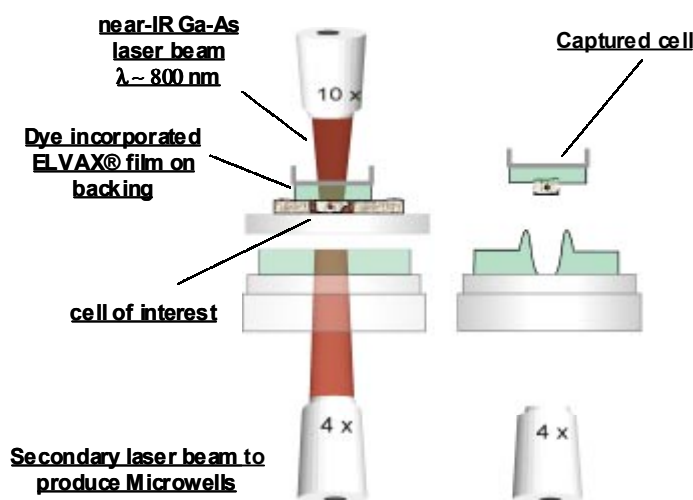

A schematic of the LCM enhanced micro-encapsulation tissue capture process.

Since the commercial introduction of LCM, in 1997, high levels of dilution in the aqueous media have often limited further analyses of extracted DNA, RNA, and proteins from the captured cells. This necessitates amplification of the analyte with the polymerase chain reaction (PCR) for further studies. Any cross contamination from healthy tissue introduces large variability in experimental observations. Microanalysis thus becomes imperative due to drastic reduction of the dilution volume for the captured cells.

Laser Capture Microdissection (LCM), a novel technique recently developed at NIH for the Cancer Genome project utilizes fusible polymer thin films to capture single cancerous cells from frozen tissue. We demonstrate the possibility of augmenting the LCM instrumentation with capabilities for encapsulation of the captured cells in micro-wells and micro-channels for in-situ analysis. With growing interest in micro- and nano-analysis, this extension with a set of tailor made micro-wells will enable bio-analysis of a single cell with dilution volumes of the order of pico- to femto-liters.

Micro-fabrication techniques using lithographic procedures have previously been used for creating arrays of microwells but have not been successfully adapted for application with LCM.

We have demonstrated that the diode laser used in the existing instrumentation may be used to create thermally induced micro-wells in dye incorporated single or multi-layer smooth polymer films. The schematic also shows capture of the cell of interest from the tissue section (top focusing objective) in concert with creation of a microwell (bottom dye incorporated film). Complete spatial registry with the captured cells facilitates micro-encapsulation.

The technique enables extension of the current capability of cell capture while obviating the necessity of further dilution. In our application, dilution volumes of pico-femto liter range are achieved.

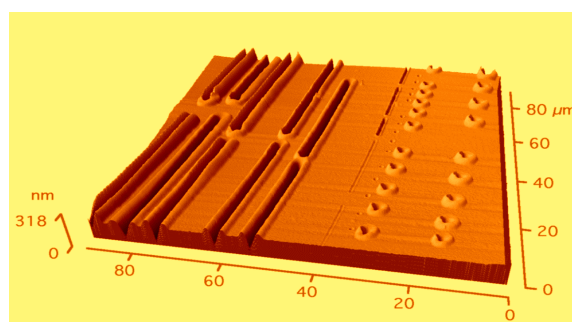

AFM of an array of laser induced microchannels and microwells on a PMMA/PS bilayer film at different laser powers and pulse times. Laser spot size is 3 μ m.

Further improvements of the technique have involved tuning the surface energy of the substratum for the tissue section from which cells are captured. Glass slides suffer from poor transfer efficiency due to protein adhesion. Dewetting a thin layer of poly(methyl methacrylate) on polystyrene in a temperature gradient yields a surface with varying surface energy, microstructure and surface roughness. The ideal surface for tissue transfer from the substrate may then be mapped in a combinatoric fashion.

Contributors and Collaborators

Amit Sehgal, Alamgir Karim, (Polymers Division, NIST)

Giovanna Cantoni, Robert F. Bonner (NIH)

Dental and Medical Materials

The Dental and Medical Materials Program provides basic materials science, engineering, test methods, and standards to sectors of the health care industry for the development of new or improved materials and delivery systems. This program focuses on (1) evaluation of synthetic materials (biomaterials) used to replace or restore function to a body tissue and (2) development of improved dental restorative materials with greater durability, wear resistance and clinical acceptability.

There is an overall risk of fractures of the hip, spine, and distal forearm that will afflict 40 % of women and 13 % of men 50 years of age and older. Regenerating form and function in bone defects in an elderly, osteoporotic population of Americans will be a daunting challenge. To meet this challenge, scientists from the Polymers Division are developing metrology methods to characterize the biocompatibility of bone grafts for bone regeneration. Quantitative methods being developed include bioassays for the adhesion, viability, proliferation, and alkaline phosphatase activity of bone cells, as well as confocal microscopy and optical coherence tomography for measuring the growth of bone cells into bone grafts. A combinatorial approach is being used to rapidly identify compositions and surface features of bone grafts that provide desirable properties such as biocompatibility and mechanical durability. In addition, scientists from the Polymers Division are developing reference biomaterials and ancillary reference data that will be used by researchers and manufacturers to improve performance of human implantable devices, such as hip and knee prostheses.

Polymer based dental composites are fast becoming the primary restorative material for the replacement of tooth structure that is lost through caries or trauma. Although significant strides have been made in improving many of the properties of these multi-phase materials, they are still considered deficient with regard to their durability, toughness and adhesion to contiguous tooth structure. Because of the multi-phase nature of composites (polymer matrix plus filler plus interface) problems also exist with regard to internal

adhesion of these three phases. Research efforts focus on improving our understanding of the synergistic interaction of these phases of the composite as well as elucidating the mechanisms of adhesion to dentin and enamel. It is expected that these studies will provide a valuable knowledge base for the development of dramatically improved composites and adhesives. A complimentary study is in progress to develop and understand the bioactivity of various types of calcium phosphate-filled composites that exhibit remineralization potential.

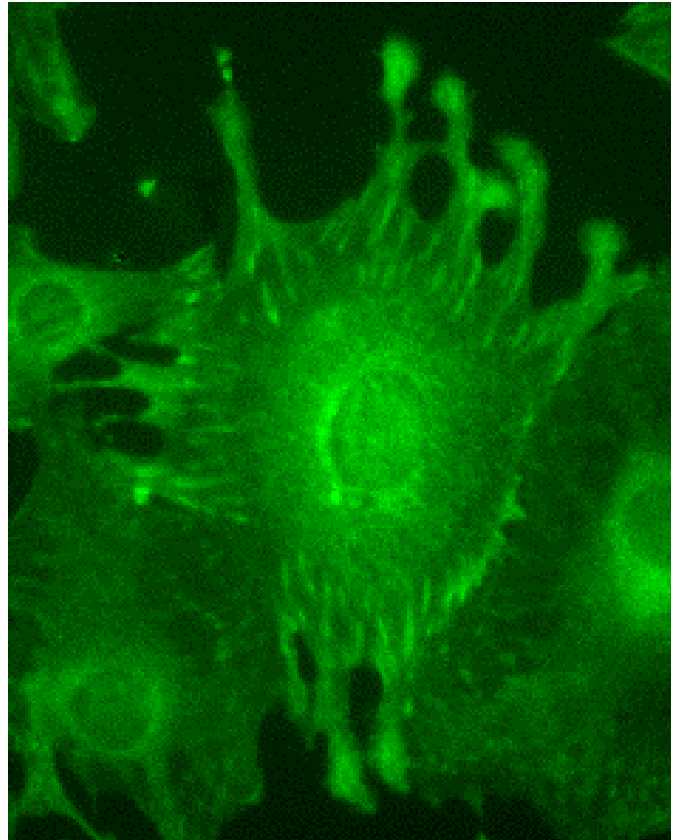

A Moldable, Resorbable, Macroporous, Composite Bone Graft Containing Growth Factor

Francis W. Wang, Carl G. Simon

The tissue engineering industry is rapidly expanding and is in need of improved measurement technology to aid in the development of new biomaterials. We are developing this technology through the design and testing of a novel composite bone graft. Techniques for assessing cell morphology, adhesion and proliferation on opaque specimens such as ours are being assessed and the best assays will be proposed as new standards to appropriate agencies (ANSI, ASTM, FDA, ISO). Thus, this project can yield a new synthetic bone graft as well as new standards for use by the tissue engineering industry

Over 100,000 operations requiring bone grafts are performed each year in the United States to repair osseous defects resulting from trauma or disease. Autografts are widely used by surgeons, but commonly have severe complications such as graft rejection, shortage of material and infection and pain at the donor site. Thus, the development of synthetic materials for use as bone grafts is a primary objective of the tissue engineering community. We are using this opportunity to develop metrology to serve this burgeoning industry and to develop a novel composite bone graft.

An ideal bone graft should be biocompatible so that it does not cause tissue damage, moldable so that it can be sculpted to fit the contours of a defect, macroporous (>200 μm dia.) to allow for tissue ingrowth, biodegradable so that it does not have to be removed and osteoconductive/osteoinductive to allow/promote graft replacement with new bone. Our graft fits each of these criteria.

Our graft consists of a calcium phosphate powder and small spheres made from a biodegradable polymer that are mixed with water to form a paste. The paste can be molded and then sets like cement within 30 minutes to form a solid matrix of microcrystalline hydroxyapatite that contains the polymer spheres. In vivo, the spheres will degrade to leave behind macropores for colonization by bone tissue. We are assessing the biocompatibility of the composite graft and are making the graft osteoinductive by adding bone growth factors.

By facing challenges that are common to the entire tissue engineering industry in the context of this real problem, we can evaluate and improve the existing biocompatibility metrology. Specifically, we have implemented new techniques for assessing cell morphology, adhesion and proliferation during culture on opaque substrates such as our bone graft. We are characterizing new fluorescent indicators of cell viability (see Figure) and are improving upon cell preparation techniques for environmental scanning electron microscopy which allows high resolution imaging of hydrated samples. In addition, we are evaluating a new colorimetric assay for quantifying cell number that is easier to use and faster than standard assays.

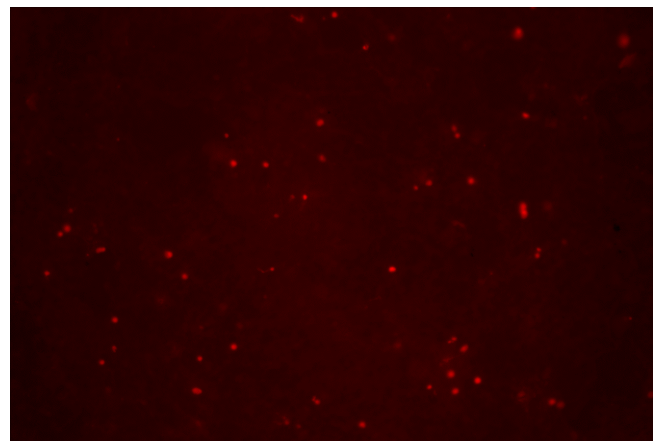
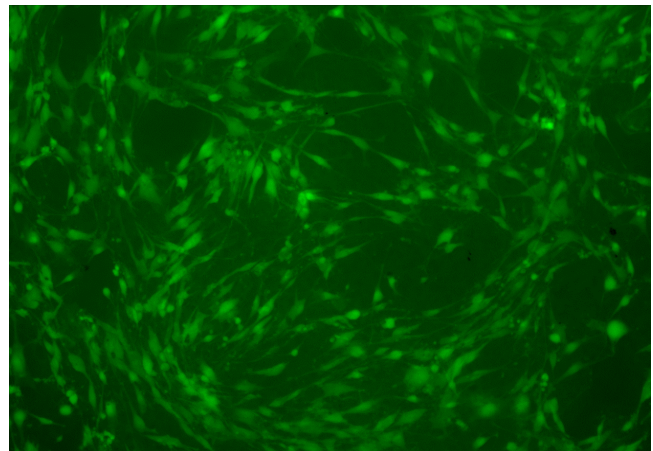

Cells growing on a bone graft specimen which has been fluorescently double-stained for live (green, top) and dead cells (red, bottom). Both panels are the same field of view seen through different filters.

After characterizing our composite bone graft with these new techniques, we will move to make the best techniques into standardized assays with the appropriate agencies (ANSI, ASTM, FDA, ISO). Thus, this project may yield a new synthetic bone graft material as well as new standards for use by the tissue engineering industry.

Contributors and Collaborators

Francis W. Wang, Carl G. Simon, Jr., Chetan Khatri, Scott A. Wight, Judy Hsui (Polymers Division, NIST) Shozo Takagi (American Dental Association Health Foundation)

Bioactive Polymeric Composites for Mineralized Tissue Regeneration

Joseph M. Antonucci

Over the broad range of solution conditions when precipitation occurs spontaneously, amorphous calcium phosphate (ACP) precedes the formation of HAP. ACP has been shown to have high solubility in aqueous media and to undergo rapid conversion to HAP, especially at low pHs. Both of these properties suggest its use as a bioactive filler in polymeric materials for the preservation or repair of enamel, dentin, cartilage and bone.

Utilizing conventional dental matrix resins (e.g. 2,2-bis[p-(2'-hydroxy-3'-methacryloxypropoxy)phenyl] propane (Bis-GMA), triethylene glycol dimethacrylate (TEGDMA) and 2-hydroxyethyl methacrylate (HEMA)) and ACP or modified versions of ACP as a filler phase, we have prepared photopolymerizable bioactive composites that had adequate physicochemical and mechanical properties and we have demonstrated remineralization potential by sustained release of calcium and phosphate ions into simulated saliva media.

Preliminary studies have shown that certain variations in methacrylate resin chemical structure and composition may affect the rate and extent of the ion release from ACP-filled composites, the internal conversion of ACP into HAP, the conversion of methacrylate groups and the mechanical properties of the composites.

Ongoing research is exploring the effects of the chemical structure and compositional variations of the resins on the release of mineral ions (Ca^{2+} and phosphate) and the degree of vinyl conversion. Conversion is being monitored by near infrared spectroscopy. The resins evaluated thus far include urethane dimethacrylate (UDMA), and a carboxylic acid-containing monomer, pyromellitic glycerol dimethacrylate (PMGDMA). Acidic monomers, such as PMGDMA would be expected to enhance the adhesive properties of the ACP composites to tooth structures. The effect of adding a potential coupling agent such as zirconyl methacrylate (ZrMA) and 3-methacryloxypropyltrimethoxysilane (MPTMS) was also investigated.

Crystalline hydroxyapatite (HAP) is considered to be the final stable product in the precipitation of calcium and phosphate ions from neutral or basic solutions and it is also the structural prototype of the major mineral component of bones and teeth. Recently, there has been increasing interest by biomaterials community in utilizing polymers of various types as matrices and as reinforcements (especially in fiber forms) for calcium phosphate-based composites. Customers for this technology include dental and biomedical manufacturers and practitioners.

In contrast to conventional glass composites, ACP composites are relatively weak in mechanical strength. In an effort to improve their reinforcing capabilities, we have modified ACP during its synthesis with glass-forming agents such as tetraethoxysilane (TEOS) and zirconyl chloride. This has resulted in modest improvement of mechanical properties, such as biaxial flexure strength. Further improvements may be feasible by the use of coupling agents with these modified ACP fillers. Another strategy for enhancing mechanical properties is to employ hybrid filler phases consisting of ACP filler admixed with silanized glass fillers and /or polymer fibers, such as oriented polyethylene fibers.

Such polymeric calcium phosphate materials are designed to be bioactive, biocompatible and highly conformable to mineralized tissue. Injectable, photopolymerizable ACP composites are feasible for facile clinical use. All ACP composites are expected to have significant remineralization potential and should find use in remineralizing white spots and caries lesions in tooth structure, especially interproximally and gingivally. If successful, ACP composites would have significant advantages over other remineralizing therapies. Currently, a strong need exists for protective liners, bases, prophylactic sealants and adhesive restoratives that are easily manipulated and that can provide efficacious long-term protection against demineralization and even have remineralization capabilities. In addition, bioactive ACP composites may find wider applications as therapeutic materials with the ability to provide osteoconductive environments conducive to promoting bone healing, such as is needed in dental (endodontic, periodontal etc.) and other biomedical applications.

In related studies other types of calcium phosphate/polymer based materials involving vitreous calcium metaphosphate or self-setting calcium phosphate cements are under investigation. Appropriate methodologies for characterizing and evaluating these materials will be utilized.

Contributors and Collaborators

J.M. Antonucci, E.D.Eanes, B.O. Fowler (Polymers Division, NIST)
D. Skrtic, G. E. Schumacher and S. Takagi (American Dental Association Health Foundation)

Structure-Property Relationships in Dental Polymers

Joseph M. Antonucci

Polymer based dental materials are increasingly being used in dentistry and allied biomedical fields. As part of a joint research effort supported by the National Institute of Dental and Craniofacial Research and also involving collaboration with the American Dental Association Health Foundation Paffenbarger Research Center, NIST is providing the dental industry and the dental profession with a comprehensive knowledge base regarding polymeric dental materials that will help elucidate the in-vitro and in-vivo performance of materials.

This project is directed toward enhancing our basic understanding of how monomer structure and variations in comonomer compositions influence the photopolymerization process and the polymeric network structure, both critical factors that determine the potential properties that can be achieved with dental polymers and their derived materials, e.g., composite restoratives. Dental polymers are often referred to simply as highly cross-linked networks with little or no characterization done beyond a measurement of overall vinyl conversion. Although the results of physical and mechanical property testing also have been widely reported for dental polymers, these data would be more useful with knowledge of how monomer structure and resin composition variations affect the development of cross-linked polymers. Generally this information is difficult to interpret and use as a guide for the development of improved materials.

In addition, the project is intended to define the currently unknown co-reactivity of structurally different co-monomers that are typically used in dental polymers. For lack of this type of information, the reactivity and cross-linking potential of dental resins are generally assumed to be equal. The use of selected model monomers is designed to demonstrate the influence of specific structural features on polymer properties and should have significant impact on the development of improved materials. An examination of non-methacrylate co-monomers, such as vinyl esters, offers a means to modify network formation and also appears to allow for higher conversion and improved mechanical properties.

It is known that widely used dental monomers such as the hydroxylated dimethacrylate Bis-GMA and the urethane dimethacrylate UDMA form strong hydrogen bonds that are of different types. The effect of hydrogen bonding on monomer viscosity is well known but its influence on the polymerization process and its potential to influence network structure has been overlooked. These aspects are being examined along with studies of some model hydrogen bonding monomers that may directly provide polymers with improved properties. An interesting example of the profound effects of hydrogen bonding involved the comparison of 2-hydroxyethyl methacrylate (HEMA) with its isomer, ethyl α -

hydroxymethylacrylate (EHMA). The stronger intramolecular hydrogen bonding of EHMA vs. HEMA has a significant effect on both monomer and polymer properties. Also, subtle changes in monomer structure, for example the substitution of ether linkages into a predominantly hydrocarbon dimethacrylate, can produce dramatic differences in polymerization rate and polymer properties. The systematic introduction of heteroatoms into dimethacrylate monomers is currently being examined to explain why these differences exist and how they can be employed to obtain polymers with improved properties. The use of multi-modal distributions of co-monomers with varied chain lengths may offer a simple means to achieve an increased level of vinyl conversion, network structure variations in the polymer and corresponding improvements in the physical, chemical and mechanical properties of dental polymers and derived materials.

A major part of this program is directed at designing strategies of maximizing vinyl conversion while minimizing polymerization shrinkage. Currently we are investigating certain urethane derivatives of Bis-GMA for their efficacy in reducing residual vinyl unsaturation and monomer content, polymerization shrinkage and the water uptake of their polymers. In addition the use of alternative initiator systems are under investigation in an effort to enhance photopolymerization efficiency and alter polymer network formation in its initial stages. While those investigations may directly provide improved monomers for dental applications, the major thrust of this project is expected to be the insights it will provide to aid in the fundamental understanding of structure-property relationship that should translate into polymeric dental materials with improved clinical performance. The utility of the results of these studies should extend well beyond the dental materials venue to include a significant number of other applications that rely on the rapid formation of cross-linked polymeric networks with optimal properties from photopolymerizable monomer systems.

Contributors and Collaborators

Joseph M. Antonucci, Chetan A. Khatri (Polymers Division, NIST)
Jeffery W. Stansbury (University of Colorado, Boulder)

Materials for Microelectronics

Today's U.S. microelectronics and supporting infrastructure industries are in fierce international competition to design and produce new smaller, lighter, faster, more functional, and more reliable electronics products more quickly and economically than ever before.

Recognizing this trend, in 1994 the NIST Materials Science and Engineering Laboratory (MSEL) began working very closely with the U.S. semiconductor, component and packaging, and assembly industries. These early efforts led to the development of an interdivisional MSEL program committed to addressing industry's most pressing materials measurement and standards issues central to the development and utilization of advanced materials and material processes within new product technologies, as outlined within leading industry roadmaps¹. The vision that accompanies this program – to be the key resource within the Federal Government for materials metrology development for commercial microelectronics manufacturing – may be realized through the following objectives:

- develop and deliver standard measurements and data;
- develop and apply *in situ* measurements on materials and material assemblies having micrometer- and submicrometer-scale dimensions;
- quantify and document the divergence of material properties from their bulk values as dimensions are reduced and interfaces contribute strongly to properties;
- develop fundamental understanding of materials needed in future microelectronics.

With these objectives in mind, the program presently consists of twenty separate projects that examine and inform industry on key materials-related issues, such as: electrical, thermal, microstructural, and mechanical characteristics of polymer, ceramic, and metal thin films; solders, solderability and solder joint design²; interfaces, adhesion and structural behavior; electrodeposition, electromigration and stress voiding; and the characterization of next generation interlevel and gate dielectrics. These projects are conducted in concert with partners from industrial consortia, individual companies, academia, and other government agencies. The program is strongly coupled with other microelectronics programs within government and industry, including the National Semiconductor Metrology Program (NSMP)³ at NIST. The NSMP is a national resource responsible for the development and dissemination of new semiconductor measurement technology.

More information about this program, and other NIST activities in Materials for Microelectronics, can be found at:

<http://www.msel.nist.gov/research.html>

¹ International Technology Roadmap for Semiconductors, 1999, and National Technology Roadmap for Semiconductors, 1994 and 1997, Semiconductor Industry Association, San Jose, CA; National Technology Roadmap for Electronic Interconnections, IPC, Lincolnwood, IL, 1995, 1997; National Electronics Manufacturing Technology Roadmap, National Electronics Manufacturing Initiative, Inc., Herndon, VA, 1996, 1998, 2000.

²<http://www.ctcms.nist.gov/programs/solder>

³<http://www.eeel.nist.gov/810.01/index.html>

Photolithography

Eric K. Lin, Wen-li Wu

Photolithography is the driving technology used by the microelectronics industry to fabricate integrated circuits. In this process, a designed pattern is transferred to the silicon substrate by altering the solubility of areas of a photoresist thin film exposed to radiation through a mask. To fabricate smaller features, next generation photolithography will utilize wavelengths requiring photoresist films less than 100 nm thick. Many new material and transport problems arise when fabricating feature sizes on this length scale. To advance this key nanofabrication technology and to evaluate the potential of a given process, we are working closely with our collaborators at IBM to apply high-resolution metrology to better understand processes under localized conditions, to guide the development of materials, and to provide high quality data. Our efforts are focused in three general areas, the physical properties of sub-100 nm polymer films, the transport of polymer chains and small molecule components over short distances, and the structural characterization of lithographically prepared structures.

In the first area, we have performed x-ray reflectivity measurements to determine the thermal expansion behavior of a model thin film polymer photoresist material, poly(hydroxystyrene) (PHS). We found that when the film thickness is less than 20 nm, the polymer film exhibits an

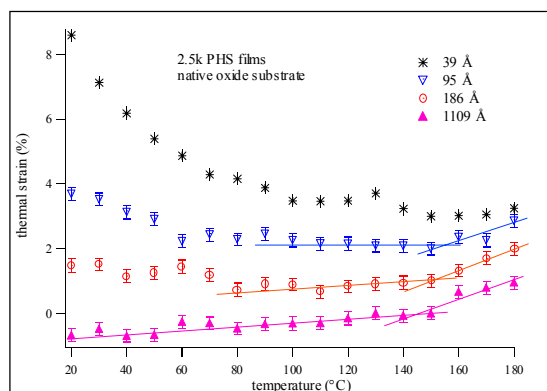

Thermal expansion of poly(hydroxystyrene) films with varying thicknesses. The curves are offset for clarity. An unusual negative coefficient of thermal expansion is observed in films less than 20 nm thick.

Photolithography remains the prevalent technology to fabricate the smaller feature sizes needed in next generation integrated circuits. The development of advanced lithographic materials and processes requires new metrology and fundamental scientific understanding at these reduced dimensions. We apply high-resolution measurement methods such as neutron reflectivity, x-ray reflectivity, and small angle neutron scattering both to understand fundamental materials and transport issues and to characterize the resolution of processes using thin film polymer photoresists.

unusual negative thermal expansion behavior. Additionally, as the film becomes thinner, the magnitude of the thermal expansion above the glass transition temperature is suppressed. This behavior has important implications in the stability and processing of thin polymer photoresist films. We are now exploring the origins of this thermal expansion behavior as a function of polymer relative molecular mass and polymer-substrate interaction energy.

Accompanying these fundamental studies, we have also developed the use of small angle neutron scattering (SANS) as a new metrology tool for the structural characterization of feature size and resolution.

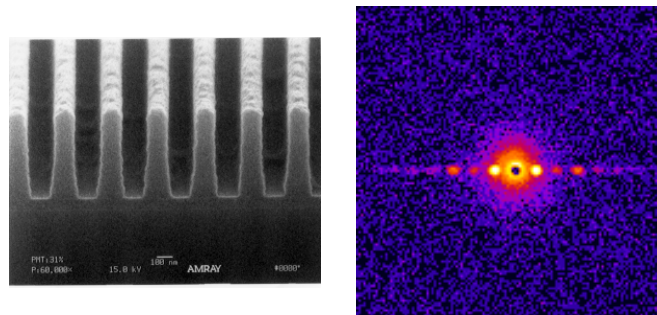

SEM (left) image and SANS data (right) from the same lithographically prepared line pattern. The lines are nominally 150 nm wide and 620 nm in height.

Unlike current microscopy-based techniques, SANS has the advantages of measuring the structure directly on a silicon wafer (silicon is transparent to neutrons), becoming less technically demanding as feature sizes decrease, and making measurements non-destructively. We have demonstrated nanometer precision in the average width of a line and a methodology to extract the average roughness or resolution of line structures shown in the above figure.

By combining our ability to measure precisely and quickly the feature size and resolution of the final structure using SANS and fundamental data from high-resolution measurements, we plan to develop an integrated program to correlate fundamental material and transport issues with the ultimate resolution of fabricated structures.

Contributors and Collaborators

Eric K. Lin, Christopher L. Soles, Wen-li Wu (Polymers Division, NIST)
Qinghuang Lin, Marie Angelopoulos (IBM)

Permittivity of Polymer Films in The Microwave Range

Jan Obrzut

We are investigating electromagnetic properties of polymer composite films for dielectric applications in microelectronics. These materials are the primary candidates evaluated by the microelectronics industry for constructing integrated passive devices such as RLC cells and de-coupling power planes integrated within chip substrates and printed circuit sub-assemblies. Current technologies utilizing surface-mounted discrete components cannot provide adequate solution at frequencies above 1 GHz, the frequency range critical for wireless technologies. In partnership with the National Center for Manufacturing Science and industry, a collaborative research consortium was organized to address this inherent problem. Our current primary goal is to develop a broadband measurement methodology based on a coaxial configuration for measuring the permittivity of film substrates.

The microstrip-resonator technique, that we developed and transferred to the industrial partners, allows for permittivity measurements of dielectric films at certain discrete resonant frequencies that do not necessarily overlap with the dielectric relaxation process. In order to address the structural/dielectric attributes in adequate detail broadband dielectric measurements are needed. However, the existing test procedures for thin films are based on lumped element approximations that fail to produce meaningful results at frequencies above 100 MHz, especially in the case of high-dielectric constant films. We have recently laid down a theoretical foundation for accurate broadband permittivity measurements of dielectric films at microwave frequencies using a coaxial configuration, and demonstrated that it is possible to extend the measurements to frequencies well above 1 GHz. This has been accomplished by finding an appropriate theoretical model for the wave propagation in the specimen section, which we treated as a distributed network consisting of a transmission line with a capacitance terminating a coaxial air-waveguide. Enabling the dielectric measurement of films at frequencies of 1 GHz to 10 GHz is very important to the industry since it covers the future wireless communication bands. The results obtained using the new scheme accurately described the complex permittivity of polymer films throughout the entire frequency range from 100MHz and 10GHz.

To advance miniaturization and functional performance of high speed electronics the industry needs high-k polymer dielectric materials for integrated passive devices (IPD). Development of the IPD technology critically depends on our ability to measure and control the permittivity of the dielectric materials at microwave frequencies. This project develops techniques for accurate measurement of permittivity at microwave frequencies and the fundamental framework for identifying the key structural and molecular attributes that control the dielectric properties of polymer composite films.

The other objective of this project is to explore the relationship between dielectric properties and structure in polymeric composites. We evaluated the microwave dielectric properties of several polymer-ferroelectric ceramic composites newly developed by the industry for integrated decoupling capacitors: BC2000™ and EmCap™ from PolyClad, CPly™ from 3M and HiK™ Polyimide from DuPont. These materials measured in a functional thin film configuration showed exceptionally good impedance characteristics that were attributed to an intrinsic relaxation process in polymer composites.

Study is underway to determine the effect of polarizability of the polymer matrix on the apparent dielectric permittivity of the composites. Our model system includes a series of polymer matrices filled with barium titanate ferroelectric powder. Since industry is primarily using cross-linked polymer resins, the polymers used in our study are all cross-linkable via photo initiation. We developed a semi-empirical model for predicting the composite dielectric properties where the parallel coupling between the organic and ceramic phases is moderated by an internally induced electric field. Our model is applicable over a volume fraction above the percolation point and predicts a considerable increase in permittivity of the composite when the dielectric constant of the polymer matrix increases. Three polymer systems with the dielectric constants 3, 4, and 10 were used to illustrate the effect of the polymer host. At the ceramic loading level of 40 vol. % the high frequency dielectric constant of the composite exceeded a value of 40. Our broad-band study of the dielectric relaxation provides clear evidence that binary mixtures of organic polymer resins loaded with ferroelectric powders exhibit an intrinsic high frequency relaxation behavior not observed before. Such characteristics make polymer composites very attractive for broad-band embedded decoupling capacitance applications that can secure the signal integrity and minimize the electromagnetic interference noise in high-speed circuits operating at microwave frequencies.

Models and measurement techniques developed in this study have been identified by a large segment of industrial producers as being crucial in new product designs and in reducing the development time of new products.

Contributors and Collaborators

J. Obrzut, C. K. Chiang, R. Nozaki, R. Popielarz (Polymers Division, NIST), J. Dougherty (Penn State Univ.), T. Hubbing (Univ. of Missouri), J. Parker (Allied Signal), Y. Lee (DuPont), J. Peiffer (3M), B. Vernell (Polyclad), T. DeRego (HADCO), J. Lauffer (IBM), D. Murry (Litton), J. Davignon (Merix), T. Tran (Raytheon), W. Li (Motorola), J. Mayers (Delphi-Delco), E. Cullens (TI), R. Charbonneau (Storage Tech.) R. Foly (DOD), L. Patch (NCMS)

Characterization of Porous Low-k Dielectric Constant Thin Films

Eric K. Lin, Barry J. Bauer

As integrated circuit feature sizes continue to shrink, new low-k interlayer dielectric materials are needed to address problems with power consumption, signal propagation delays, and crosstalk between interconnects. One avenue to low-k dielectric materials is the introduction of nanometer scale pores into a solid film to lower its effective dielectric constant. However, the characterization of the pore structure of thin nanoporous low-k dielectric films is not straightforward. The small sample volume of 1 μm films and the desire to characterize the film structure on silicon wafers narrows the number of available measurement methods. We have developed a novel combination of small angle neutron scattering (SANS), high-resolution x-ray reflectivity (HRXR), and ion scattering techniques to determine important structural and physical property information about thin porous films less than 1 μm thick. These measurements are performed directly on films supported on silicon substrates so that processing effects can be investigated. HRXR is used to accurately measure the film thickness, the average film electron density, and the coefficient of thermal expansion. SANS is used to determine the pore structure providing information such as the average pore size, pore connectivity, and moisture absorption. Ion scattering techniques are used to determine the elemental composition of the films.

During the past year, we have focused our efforts into three areas: characterizing current industrially relevant materials through International SEMATECH, gaining fundamental understanding of different classes of material preparation, and conducting an international round robin comparison of different on-wafer measurement techniques. International SEMATECH, a consortium of microelectronics companies, provided more than 25 separate samples for characterization by NIST, including spin-on glass materials, films from chemical vapor deposition, and organic thin films. The structural information provided by NIST is placed into a master database that includes data from a variety of sources, detailing both the structural and material properties needed to evaluate candidate materials. Member companies make extensive use of the data to guide the development of low-k dielectric materials for integration into future devices.

NIST is working to provide the semiconductor industry with unique on-wafer measurements of the physical and structural properties of porous thin films important to their use as low-k dielectric materials. We have developed a novel methodology utilizing several complementary experimental techniques to measure the average pore size, porosity, pore connectivity, film thickness, matrix material density, coefficient of thermal expansion, moisture uptake, and film composition of several classes of candidate porous thin film materials.

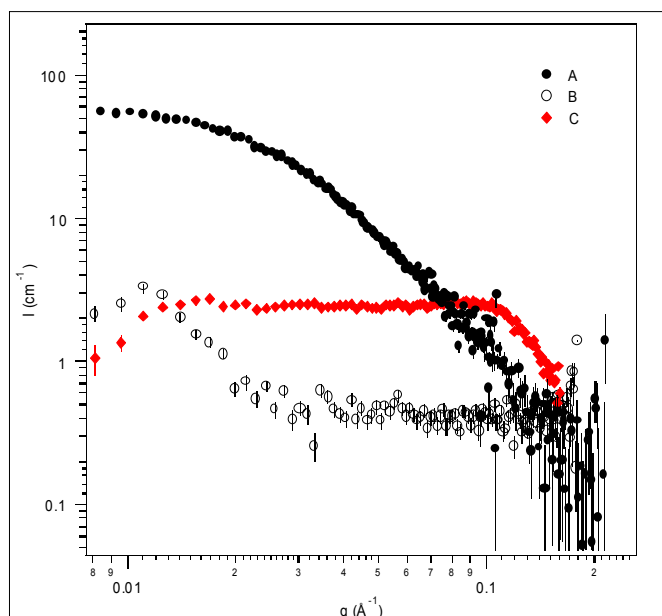

Representative small angle neutron scattering data from three different types of porous low-k dielectric thin films.

We have also collaborated with several groups including researchers at Dow Corning, Lucent, and Sandia National Labs to provide measurements to better understand fundamental issues in general classes of sample processing methods. Finally, we have established an international collaboration including private, government, university, and corporate research groups from NIST, IMEC (Europe), ISP (Novosibirsk), the University of Michigan, the Kyushu Institute of Technology, CCIC, Ltd. in Japan, and Dow Corning to critically compare data from several different on-wafer measurement methods for the structure of porous thin films. The techniques, including the NIST methodology, ellipsometric porosimetry, and positron annihilation lifetime spectroscopy, are used to determine average pore size, film porosity, pore connectivity, pore wall density, and the pore size distribution. It is expected that the results from this collaboration will provide a needed overview and practical guidelines for researchers to rigorously characterize the structure of porous low-k dielectrics.

Contributors and Collaborators

E.K. Lin, B.J. Bauer, H. Lee, H. Wang, W. Wu (Polymers Division, NIST)
 Jeff Wetzel, Changming Jin, Jeffrey Lee (International SEMATECH)
 Mikhail Baklanov (IMEC), David Gidley (University of Michigan)
 Wei Chen, Eric Moyer (Dow Corning), Shu Yang (Lucent)
 Hongyou Fan, C. J. Brinker (Sandia National Laboratory)

Measurement of In-Plane CTE and Modulus of Polymer Thin Films

Martin Y.M. Chiang, Chwan K. Chiang

There have been many methods developed to measure the properties of thin films widely used in electronic packaging applications. Two important properties for thin films in their packaging applications are CTE and elastic modulus because they govern the residual stresses. Excessive residual stress can often lead to the failure of the electronic devices. A number of methods are available to probe the CTE and elastic modulus of supported thin films. The basic concept among the methods is that the CTE and modulus can be calculated through equations connecting the response of a film/substrate system perturbed mechanically, thermally, acoustically, or optically.

We have applied a non-contact bending plate technique to measure the in-plane CTE and modulus of polymer thin films deposited on rigid substrates. Figure 1 shows schematically the measurement set-up of a bimaterial circular plate consist of a thin film and a substrate; the bending results from a mismatch in CTE between the thin film and the substrate. Under a constraint free condition, the plate will deform to a spherical shape when its temperature is different from a reference temperature at which the plate is stress-free. Figure 2 shows a typical image of a deformed plate and numerical data of measured deflection from a test specimen.

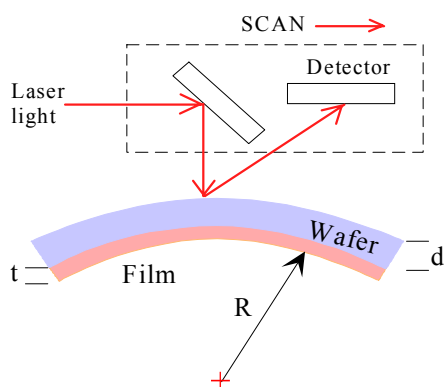

Fig. 1

To calculate both CTE and modulus, it is necessary to measure the deformation of two different samples (using the same film material but different substrate materials) at the

Polymer thin films are used in many electronic packaging applications. The satisfactory operation and fabrication of many devices depends critically on the integrity of films to withstand hostile end use and processing environments. Characterization of thin films is important to predict the lifetime and to ensure a successful fabrication process. Our objective is to develop a simple and reliable measurement technique for determining the in-plane coefficient of thermal expansion (CTE) and elastic modulus of supported thin films, two parameters dictating the level of residual stress in devices.

temperatures. This provides a set of two coupled algebraic equations with two unknowns (CTE and modulus of the film). In the previous approach, the residual stress of the film was first calculated from the bending curvature; the CTE and modulus were then calculated by differentiating the stress as a function of temperature. There are two major deficiencies in this approach; both the CTE and the elastic modulus are assumed to be constant over the temperature range studied, the differentiation process often lead to additional uncertainty in the final results. In our work the film properties are directly calculated based on the bending curvature at any given temperature provided the reference (stress free) temperature has been determined beforehand. Our approach is more robust than the previous one; it does not require differentiation and can provide the in-plane CTE and elastic modulus of a supported thin film at each measurement temperature. For polymeric materials this capacity is rather desirable because both elastic modulus and CTE of polymers often exhibit strong temperature dependence.

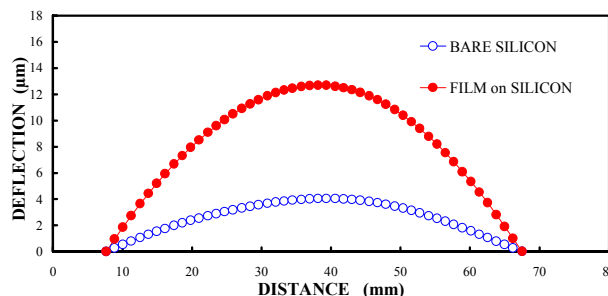
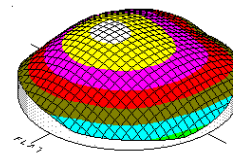

Fig. 2

Contributors and Collaborators

M. Y. M. Chiang, C. K. Chiang, and W. L. Wu (Polymers Division, NIST)
D. Feiler and W. Xia (Conexant Systems, Inc.), Dow Chemicals

Electronic Paper

Chad R. Snyder, Erik K. Hobbie

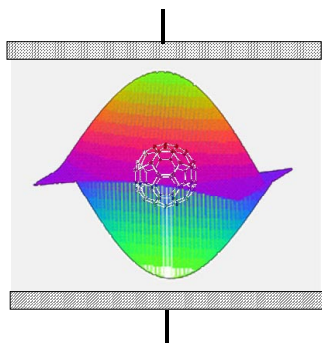

To understand the electrophoretic response of E-paper, the dielectric properties of the individual particles need to be determined. This is a general problem that is particularly pressing in the area of modeling nanoparticle dispersions where the particles are in between “molecular” and “macroscopic” states. Therefore, while the electrophoretic behavior is the main thrust of this project, a large fraction of the effort has been directed towards determining the length scale over which continuum models of the dielectric constant are applicable.

Electrophoretic Phenomena. To examine the dynamic response and bistability of electrophoretic suspensions, a sample cell was designed and constructed that allows video microscopy measurements of micro-scale colloidal suspensions in the presence of static and dynamic electric fields. We have focused on suspensions of 3 μm polystyrene (Latex) particles in buoyancy matched solutions of 50/50, by volume, water/heavy water. This cell has been used to measure the dynamic response of suspensions in contact with ion exchange resin to sudden application and removal of static electric fields of 6/5 V/cm. (Migration of the particles to one of the electrodes is “pixel on”; switching the fields off or reversing the bias is “pixel off”.) Preliminary measurements suggest that space charge plays a significant and complicated role in the dynamic response and bistability of such monodisperse suspensions, and future experimental and theoretical work will attempt to address this issue.

As part of the future work to explore the feasibility of adding a small amount of a second, smaller colloidal component to promote entropic clustering and enhance bistability,

In our progression towards a “paperless” society, new display methods are critical – one of the more promising display classes is based upon electrophoresis; prediction of the properties of these systems is non-trivial. NIST is attempting to develop the metrology and fundamental knowledge for characterizing micro- and nano- particle suspensions in terms of their electrophoretic bistability and switching speed. As a part of this project, the fundamental effect of particle size on the bulk dielectric properties of nanofilled materials is being examined.

measurements of internal dynamics and gel/crystalline elasticity have been performed for entropic monolayers confined to a glass surface, and measurements of the kinetics of phase separation and crystallization in buoyancy-matched polymer-colloid and colloid-colloid mixtures have recently been completed.

Dielectric Properties of Nanofilled Systems. To determine on what size scale continuum mixture models can be reasonably applied, i.e., where the “solvent effect” is negligible, a model “spherical” nanofilled system was examined – buckminsterfullerene (C_{60}) in solvents of various polarities. The static dielectric constant ϵ of C_{60} particles was determined in *cis*-decalin, toluene, and 1,2-dichlorobenzene (ODCB) using continuum models for spherical and spherical shell inclusions. Spherical-shaped models were deemed to be reasonable after modeling was performed on the geometry of the truncated icosahedron (C_{60} geometric shape). For comparison, the relationship for ϵ of a dilute mixture of solid truncated icosahedrons differs from that of a perfect sphere by only 1 % of ϵ (i.e., a factor of 3.0409 vs. 3 for a sphere).

The value for ϵ for isolated C_{60} in *cis*-decalin and toluene agreed well with molecular beam measurements using a spherical shell model, but the ϵ estimate in the highly polar solvent ODCB deviated from these other measurements. Preliminary measurements have indicated large deviations of molecular beam and solution measurements of ϵ of C_{60} in the case of the highly polar solvent, ODCB. Polar solutions are subject to a number of complications and it is not yet clear where fundamental modifications of the continuum model are necessary.

A great deal of further experimentation will be necessary to determine whether or not continuum models can successfully predict bulk material properties of nanoparticle filled materials based upon the appropriate parameters for the matrix and the inclusions. However, we feel that this work does suggest that careful choice of a matrix will allow for determination of the dielectric properties of nanometer-scale objects. It should also be possible to extend this approach to many other properties of interest (shear modulus, refractive index, magnetic permeability, etc.) so this simple method promises to have wide applicability.

Contributors and Collaborators

Chad Snyder, Erik Hobbie, Jack Douglas (Polymers Division, NIST)
Marc Mansfield, Stevens Institute of Technology
James Martin, Sandia National Laboratory

Hygrothermal Expansion of Polymer Thin Films

Chad R. Snyder, Wen-li Wu

Polymer thin films are widely used in electronics packaging applications, however the properties of these thin films can be significantly different from those of the material in its bulk form. We are providing the electronics industry with robust measurement tools and data for characterizing the dimensional stability of polymers. NIST has designed, developed and demonstrated the capabilities of a capacitance-based metrology with outstanding sensitivity for measuring the out-of-plane expansion of these thin films.

We are currently engaged in several activities to aid in the adoption of our capacitance-based metrology by industrial users. The first such activity involves extending the measurement capabilities of the technique to a wider variety of samples. To this end, a capacitance cell that can measure the thermal expansion of insulators, semiconductors, and conductors, has been designed, constructed, and tested. The accuracy of the new capacitance cell design for thermal expansion measurements on conducting and semiconducting samples has been demonstrated by measurements on a 0.6 mm thick p-doped <100> oriented single crystal silicon. As can be seen in the plot, our data are in excellent agreement with the recommended expansion data.

A second activity that is currently being pursued to accelerate the adoption of our technique involves working with standards-setting bodies to explore the desirability of introducing the technique as a standard method for measuring thermal and hygrothermal expansion. After extensive discussions with the chairperson of The Institute for Interconnecting and Packaging Electronic Circuits' (IPC) HDIS Test Methods Group, the format for our test method has been decided upon and is in a draft form.

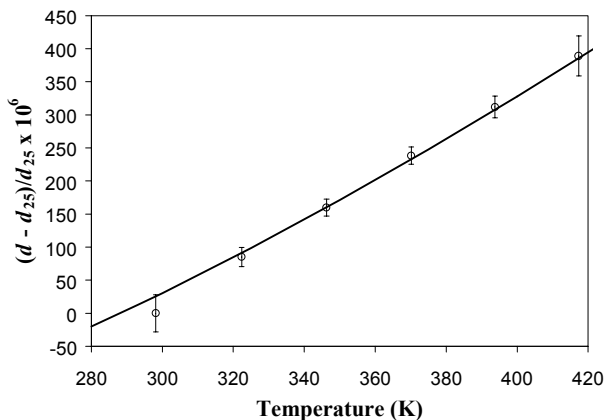

Thermal expansion of single crystal <100> oriented silicon relative to its value at 25 °C (d_{25}). The line corresponds to the recommended expansion data from the literature. (The error bars are the best estimate of two standards deviations in the experimental uncertainty.)

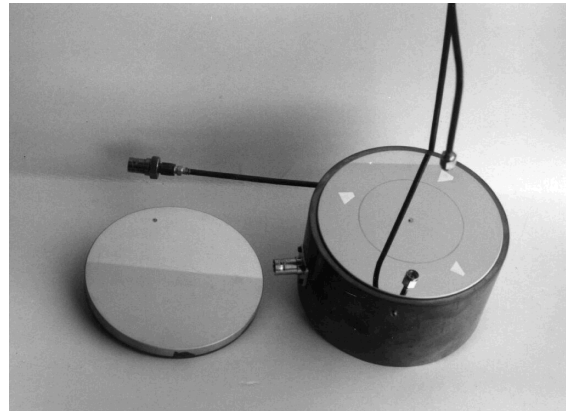

One final activity involves working directly with industrial users that have identified a specific use for the capacitance cell metrology. In this activity, we provide them with detailed designs for construction of the capacitance cell and work with them to modify the designs to better serve their purposes. Currently, we are working with two such users: Los Alamos National Laboratory (LANL) and Xerox Corporation, both of whom have received the detailed instructions for construction of the capacitance cell electrodes and holder. LANL has expressed great interest in adopting the capacitance cell metrology for measuring the swelling of thin polymer films in the presence of supercritical fluids and has been in contact with the NIST Optical Shop regarding construction of their own capacitance cell. Xerox Corporation is interested in using the metrology for measuring the coefficient of hygrothermal expansion of thin polymer films.

The capacitance cell methodology is capable of handling films with thicknesses above 2 μm . However, needs exist for measuring thermal expansion of films one μm thick or less. One noticeable example is the industrial need of the coefficient of thermal expansion (CTE) of interlevel dielectrics used in on-chip interconnects. To meet this need, equipment and measurement protocols based on high resolution x-ray reflectivity have been developed; the CTE of films with thickness ranging from 5 nm to 1.3 μm has been routinely collected and the results have been disseminated to International SEMATECH and many material suppliers.

Contributors and Collaborators

Chad Snyder, Wen-li Wu (Polymers Division, NIST)
Angela Strongy, Xerox Corporation
Jim Wheat, Los Alamos National Laboratory

Assembly Of IC Chips Using Wafer-Level Underfill

William E. Wallace, Daniel Josell

For area-array flip chip applications, the microelectronics industry has a well-established need for an underfill system that obviates the time-consuming flow required by current viscous polymeric underfill materials. The most promising route to accomplishing this is the application of an integrated underfill/solder bump system at the wafer stage. We have provided materials data and computer simulation that show behavior to be expected during assembly of flip chips that have an underfill/solder bump system applied at the wafer level.

This project addresses the critical problem of wetting behavior of solder in solder joint interconnections under the constraints found in the wafer-level underfill systems. The pre-existing underfill geometry provides constraints on the flow of the solder, influencing the self-alignment of the die and final solder joint geometry. These factors have profound effects on joint reliability. Thus, behavior of the solder during reflow is a critical aspect of the underfill system, which is itself supposed to enhance reliability.

The three specific goals of this project are: 1) create modeling software for evaluating capillary induced realignment forces; 2) carry out validation experiments for realignment forces provided by solder joint to misaligned pads; 3) develop a model incorporating capillary realignment forces as well as viscous forces retarding realignment associated with polymer underfill material.

The accomplishments to date are:

Software based on the freeware Surface Evolver code has been written that allows modeling of two relevant joint geometries. This software was placed on the CTCMS web site: <http://www.ctcms.nist.gov/~djl/solder/new.html>

Measurements of solder joint dimensions, specifically stand-off height and lateral offset (i.e., misalignment), as functions of the applied force (normal and shear), solder size (0.029, 0.0086, 0.0063 and 0.0019) mm³, and pad diameter (0.65 and 0.35) mm were conducted.

A manuscript entitled "Misalignment of flip-chip solder joints: prediction and experimental determination of lateral and normal force-displacement curves" (D. Josell, W.E. Wallace, J.A. Warren, D. Wheeler, and A.C. Powell) was submitted to *The Journal of Electronics Packaging*.

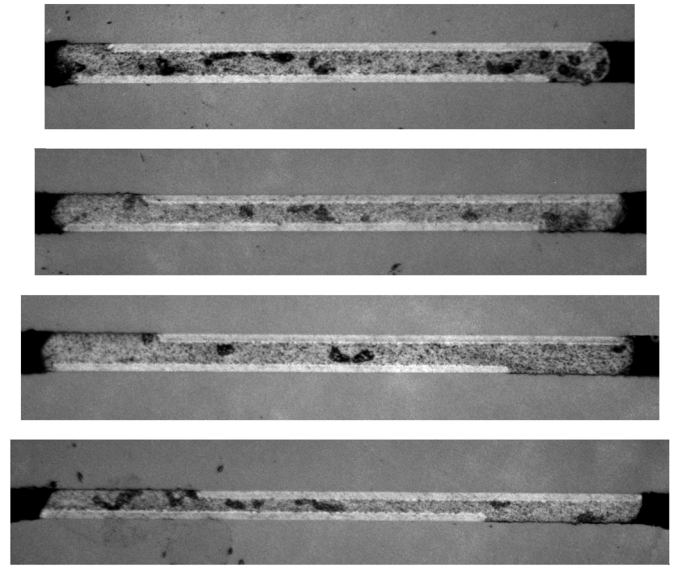

100 μm

FIGURE: Cross-sectioned 0.35 mm solder joints. From top to bottom the lateral shear force is: 34 μN , 68 μN , 1.0 mN and 1.2 mN. Normal forces are approximately 1.95 mN. Pad dimensions are not exactly 0.35 mm because cross-sections do not exactly bisect pads. This introduces no error in the measured lateral offset because any cross-section parallel to the displacement direction for two circular pads will yield the same value.

Contributors and Collaborators

William Wallace (Polymers Division, NIST)
Daniel Josell (Metallurgy Division, NIST)

Multiphase Polymeric Materials

The multiphase polymeric materials program develops realistic measurement and characterization platforms for multiphase polymeric materials that use a combination of experimental measurements and theoretical and computer (T/M) modeling tools to provide realistic and highly optimized output. These measurement and characterization tools and platforms are intended to help industries in pre-production evaluation, materials characterization and performance prediction, as well as provide data for process design.

In order to achieve the performance requirements in modulus, stiffness, toughness, temperature, chemical and environmental stability, and even provide the desired appearance and touch, most polymeric materials in use are either phase separated blends with two or more components, and/or filled with particles or short/long fibers. The challenge in using multiphase polymeric materials extends from the processing design, through structure and properties prediction and characterization to service life prediction. This program is designed to use theoretical and computational modeling tools in conjunction with characterization measurements to form realistic and workable tool sets.

Specifically, characterization techniques will be developed and used to generate relevant data bases or constitutive relations to be used as input for theoretical and computer modeling tools to provide more realistic T/M and bridge the gap in current T/M tools. Current theoretical and computational tools are capable of modeling fine length scales such as nano-scale molecular dynamics simulations, micro-scale self consistent field or density functional methods, and meso-scale time dependent Ginsburg-Landau or Cahn-Hilliard-Cook techniques. On the other hand, macroscopic part sized finite-element-flow calculations and Object Oriented Finite element analysis (OOF) for properties calculations and virtual testing are much coarser grained tools. A seamless connection between these two sets of computer tools is not available to provide realistic materials properties for design, prediction, and characterization.

This program is currently working on three materials characterization projects to provide: 1. Phase separation/crystallization results together with interfacial characterization and rheological data to form constitutive relations as input for finite-element-flow modeling, and characterization of phase structure. 2. Structure, dynamics,

and modulus characterization in high surface area particle filled polymers and blends for performance characterization and validation of multiscale computer modeling. 3. Fiber tow characterization and failure results as input to finite-element based mechanics and performance evaluation. All three projects are linked to future poly-OOF for property prediction and virtual testing.

This program works with industrial companies through collaboration, CRADAs, and consortium arrangements. This includes resin suppliers, system suppliers, parts producers, and auto-industry and offshore oil platform companies for method and technique dissemination.

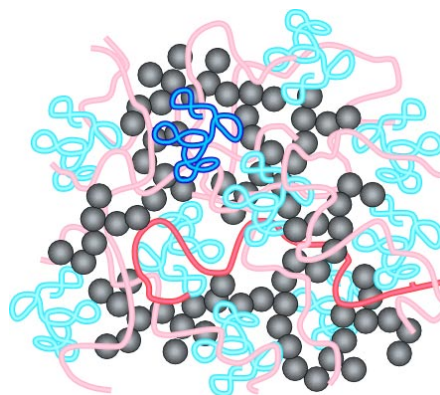
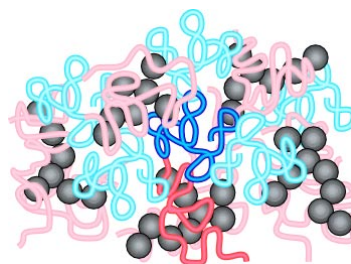

Schematic showing the influence of percolation on the dynamic behavior of bound polymer chains. Top – Unpercolated filler aggregates with bound polymer (red) compared to unbound polymer (blue). Bottom – Percolated filler aggregates with bound polymer (red) compared to unbound polymer (blue).

Contact Information: Charles C. Han

Constitutive Relationship of Polymer Blends for Process Modeling Needs

Erik K. Hobbie, Charles C. Han

The ultimate morphology obtained in polymer blending is a complicated function of blend phase behavior, processing conditions, and mold geometry. By combining a universal picture of blend morphology and phase behavior under shear with the flow properties of a given mold geometry, we hope to produce a software package that will predict blend properties, and hence performance, as a function of position within the final product.

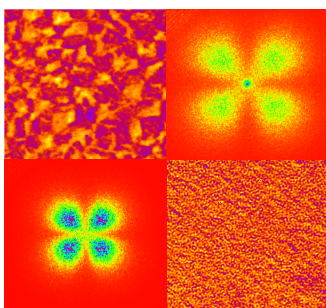

The first stage of this project is to garner a detailed and quantitative understanding of the equilibrium phase behavior of a number of different polyolefin blends. In addition to phase separation, these blends exhibit subsequent crystallization upon cooling, and the work to date has focused on the influence that phase separation has on the kinetics of spherulitic growth. Once this aspect of the morphology is well understood, the focus will shift to the non-equilibrium phase behavior under shear flow, from which a constitutive relationship encompassing temperature, pressure, shear rate, and blend composition will be formulated. From this relationship, we seek to predict droplet shape, composition, and phase after quenching a blend into a mold of arbitrary geometry. This would enable industrial users to predict material performance *a priori* under different conditions, hence optimizing and enhancing product quality.

The materials on which we have focused are polyolefins with statistical copolymers of ethylene/hexene (PEH) and ethylene/butene (PEB). Here only PEH is primarily crystallizable. Because of the almost identical refractive index, optical measurements are difficult. The phase boundary (temperature/composition) has been determined in three different ways; a combinatorial technique that uses photo intensity in the presence of a temperature gradient following a quench to room temperature, a measurement of the transmitted light intensity, and small angle light scattering. From this we get the complete phase diagram, which shows typical upper critical solution temperature, UCST, behavior ($T_c = 146\text{ }^\circ\text{C}$, $\phi_{\text{PEH}} = 0.44$) intersected by a line of crystallization.

Phase Diagram of PEH/PEB, $\chi = -5.5 \times 10^{-4} + 0.5/T$

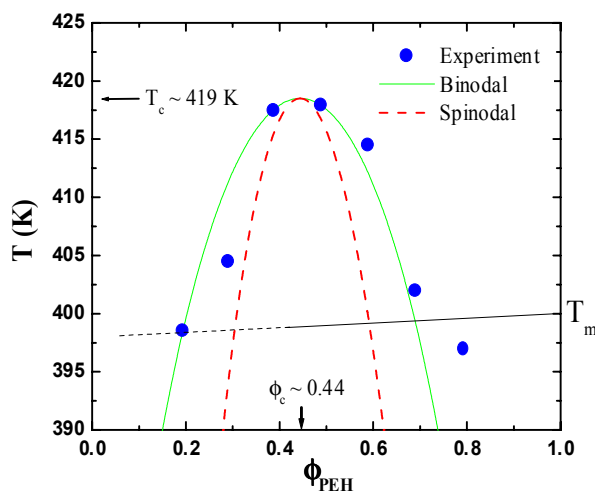

To study how the liquid-liquid phase separation limits the crystallization, we used time-resolved small-angle light scattering, time-resolved wide- and small-angle X-ray scattering, optical microscopy, and atomic force microscopy. For optical measurements, phase-separated samples are quenched to room temperature, where subsequent crystallization introduces sufficient optical contrast to discern liquid-liquid domains. In future studies, one of the polymers will be labeled with a co-monomer that will enhance the difference in refractive index between the two components, thus allowing us to directly visualize the phase-separated domains under simple shear flow.

A novel feature suggested by the data is that the presence of domain interfaces arising from liquid-liquid segregation acts as an inhibitor to crystallization at late times, so the size of the spherulites becomes kinetically pinned. The situation is thus complicated, since crystallization kinetics is influenced by both the composition of the internal phase *and* the shape and size of the phase-separated droplet. The kinetics of spherulitic growth can be adjusted with respect to the phase ordering kinetics by varying the isothermal temperature.

Contributors and Collaborators

H. Wang, A. Nakatani, G. Schmidt, K. Shimizu (Polymers Division, NIST)
 M. Langhorst, Wu (Dow Chemical)
 D. Nguyen (PPG)
 A. Halasa (Goodyear)
 R. Weiss (University of Connecticut)

Characterization and Modeling of Interfaces and Interphases of Polymeric Systems

Frederick R. Phelan Jr., Charles Han

The injection molding of polymer blends produces a complex microstructure in which drops of one phase are dispersed in a matrix phase. The detailed morphology depends on the fluid mechanical deformation history, component rheological properties, and blend thermodynamics. The goal of this project is to gain a fundamental understanding of the interplay between process parameters and blend microstructure, and develop a computational software tool for predicting the microstructure evolution of polyolefin blends in injection molding operations for industrial users.

We are currently engaged in a project to predict the microstructure that forms during the injection molding of polymer blends. Polymer blend mixtures are generally injection molded while phase separated. In such systems, droplets of a dispersed phase are suspended in a matrix phase. Blend mixtures usually enter an injection molding cavity with more or less uniform drop size from an extruder. However, upon entering the cavity, the drops are highly sheared and break-up into finer and finer sizes near mold walls, and relax (and possibly even coalesce) towards equilibrium sizes in regions of low shear. This leads to a non-uniform “skin-core” microstructure in the final part, which highly affects properties.

We are in process of putting together a simulation that predicts drop size distribution and morphology in injection molded polymer blends. The first activity is a measurement program in which we measure drop size and aspect ratio as a function of shear rate and composition in blend mixtures. Example data for a polyisoprene-polybutadiene blend is shown in the figure to the right. In addition, the shear viscosity as a function of composition is measured.

As a first order model, these data are employed in custom subroutines for viscosity and drop size to the commercial fluid dynamics package FIDAP. From the computed shear rates, we can map the final drop size distribution in the mold. An example is shown in the lower figure. As expected, the

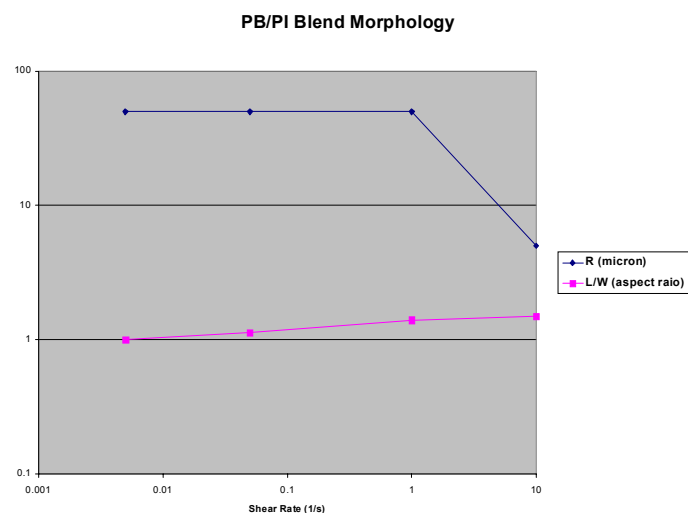

model predicts a very small drop size at the wall, which gradually increases towards the center.

This simulation represents a first order method for predicting morphology in polymer blend mixtures. It is only first order because it predicts that the drop size changes instantaneously with shear rate, whereas in actual systems, at a given shear rate it takes a finite time for break-up to occur. We are in the process of studying dynamic effects through flow simulation and development of appropriate theory. However, for thin cavities with no recirculations, the first order model is expected to yield adequate results except near the entrance region.

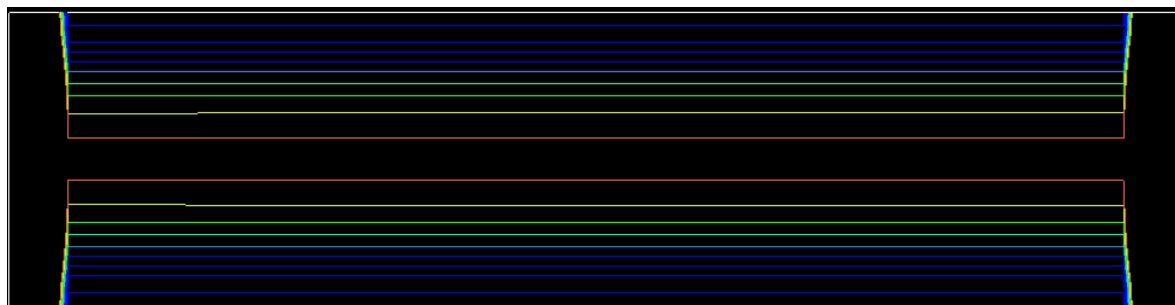

Contributors and Collaborators

F.R. Phelan, Jr., E.K. Hobbie, H. Wang, C.C. Han, S. Glotzer (Polymers Division, NIST)
 Tinh Nguyen (Building Materials Division, NIST)
 Polymer Interphase Consortium (NIST, Dow Chemical, PPG, Visteon)

Synergistic Interactions Of Polymers With High Surface Area Nanofillers

Alamgir Karim, Charles Han

The use of fillers to modify polymers has long been an important aspect of the polymer industry. With an increased emphasis toward tailoring material properties instead of simply providing inexpensive extending agents, a comprehensive fundamental understanding of filled polymers is preferable to current empirical approaches. The objective of this project is to provide a fundamental understanding of the mechanism of polymer reinforcement with particulate materials and correlate these measurements with mechanical behavior and desirable material properties.

The research topics are based on a survey of industrial needs conducted at a workshop on Interactions of Polymers with Fillers and Nanocomposites sponsored by the NIST Polymers Division. The topics include: 1) the dynamics of polymer bound to the surface of carbon black fillers determined by inelastic neutron scattering, NMR and microscopy methods, 2) molecular dynamics simulations of polymers near a filler surface, the structure and properties of nanoclay-polymer suspensions under shear by flow birefringence, rheological methods and in-situ shear small angle neutron scattering (SANS) experiments, 3) the influence of particles on the phase separation behavior of polymer blends by light scattering and calculational methods, and 4) the suppression of dewetting behavior in nanofilled polymer thin films.

The dynamics experiments indicate that the dynamics of the bound polymer layer are different for carbon black concentrations below and above the percolation threshold of the carbon black. This indicates that the state in which the bound polymer is prepared is as important as the amount of bound polymer. Coupled with the dynamics calculations, an improved understanding of the mechanism of reinforcement is possible.

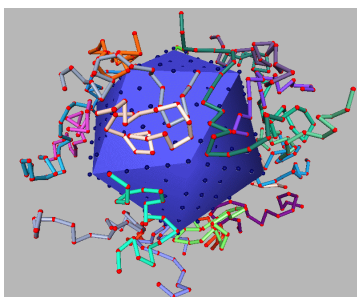

Model filler particle interacting with polymer chains.

The dynamics calculations show that the T_g shifts and surface dynamics observed experimentally can be explained by the nature of the polymer-filler interaction. A flattening of the polymers near the filler surface was also observed, which is largely insensitive to the polymer-filler interactions. The results provide guidance for the design of custom filled and nanofilled materials and support for an explanation of the origin of T_g shifts in polymer thin films in terms of surface interactions.

The results on the flow behavior of clay-polymer solutions show an unexpected orientation of the clay platelets during flow and provide evidence for a dynamic network between the polymer chains and clay platelets that explains some of the viscoelastic behavior of these solutions. The work provides a reference point for similar studies on flow behavior of bulk nanocomposites and thin film studies.

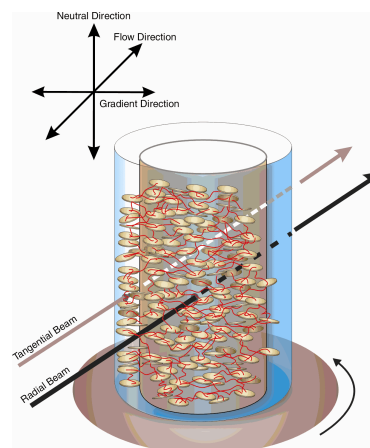

Schematic of orientation of clay platelets and polymer chains during shear in the SANS shear cell.

Simulations of phase separation at high filler content show strong interference effects in the concentration wave around the filler particle that have a profound effect on the phase separation morphology. Various surface treatments shift the phase boundary of a blend reflecting the interaction strength between the filler and blend components.

The work resulted in a CRADA with Dow Corning Corp. that will characterize polymer kinetics and dynamics near the surface of silica fillers. SANS studies will be conducted on end-linked, labeled chains incorporated into a filled network as a function of deformation and type of filler. Another CRADA with Michelin Americas Research and Development Corp. will measure the dynamics of styrene-butadiene rubber (SBR) as a function of the monomer ratio by various neutron scattering techniques. Selectively labeled copolymers will allow observation of the individual comonomers.

Contributors and Collaborators

A. Karim, C. Han, G. Schmidt, A. Nakatani, J. Douglas, D.-W. Liu, V. Ferreiro, D. VanderHart, S. Glotzer, F. Starr (Polymers Division, NIST)
R. Ivkov, P. Papanek, P. Butler, R. Dimeo (NIST Center for Neutron Research)
Dow Corning Corporation, Sid Richardson Carbon Co., Southern Clay Products

Mechanics of Fiber and Nano-Filled Composites

Gale Holmes, Charles Han

To facilitate the use of composites in automotive and infrastructure applications, computational models are needed that predict composite failure behavior and establish failure probabilities for composite structures. In this project, a measurement platform is being developed that determines the energy dissipation mechanisms that govern the initiation and propagation of damage in composites using data from fully constrained model composites. These data will link micromechanics failure parameters to tow-based failure behavior using the chain-of-bundles modeling approach.

This new project builds on expertise gained from NIST research on factors that influence adhesion at the fiber-matrix interface of fibrous composites. In this project, 3-D multi-fiber model composites are being investigated to quantify the impact of fiber-fiber interactions on the deformation and failure behavior of composites. Fiber-fiber interactions are known to be a key micromechanics parameter that must be accounted for if composite failure behavior is to be understood and modeled using computational tools. Existing data from 2-D (partially constrained) multi-fiber arrays have shown that the adhesion and failure behavior of a fiber is influenced by the presence of fibers that are within 5 fiber diameters. Current micromechanics models cannot account for this behavior. In addition, nucleation and propagation of crack clusters in composites are poorly understood. As an example, Monte Carlo simulations using the chain-of-bundles modeling approach have been successful in qualitatively capturing changes in the failure behavior of unidirectional composites. In the model, altering the value of the fiber Weibull shape parameter captured the change from brittle to brush-like failure behavior. Experimentally, the change in failure behavior was achieved by changes in the matrix properties, fiber-matrix adhesion, and fracture toughness of the fiber-matrix interface strength and not by changing the fiber.

A critical shortcoming of 2-D array research is that the prediction of stress-concentration factors on the fiber adjacent to a fiber break could not accurately be predicted by the local load-sharing rules used in the chain of bundles model. This discrepancy was attributed in part to the lack of total constraint around the broken fibers. Therefore, the key parameters that are needed to predict fiber tow failure from micromechanics data must be obtained from 3-D fiber arrays. To achieve the third dimension in a hexagonal array the spacing between layers at 1 fiber-diameter must be approximately 13 μm . Since the fiber diameter variation between fibers is $(15 \pm 5) \mu\text{m}$, variations in the interlayer spacing of approximately $(3 \text{ to } 4) \mu\text{m}$ are acceptable. We propose to achieve the third dimension by building sets of steel steps graduated by the appropriate spacing to achieve the desired inter-fiber spacing (see Figure 1).

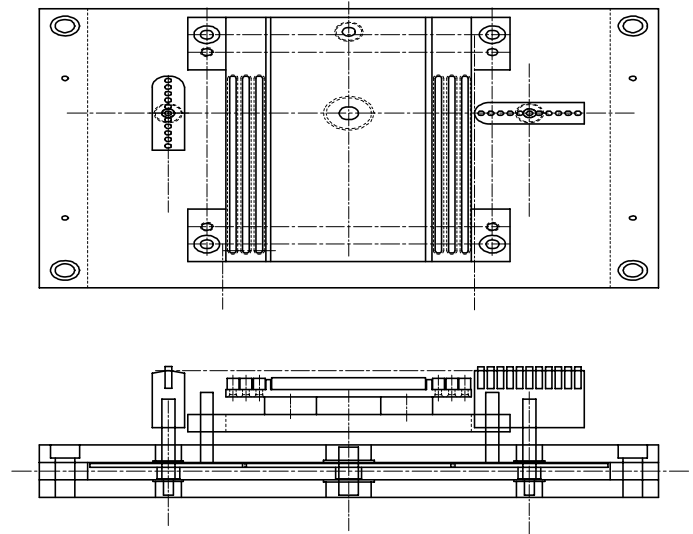

Figure 1

Each array of fibers will span across the matched steps to achieve equal spacing between fibers within the layer. Milling the sets of steps to achieve the desired interlayer spacing will push the limit of machining technology. To minimize variability within a layer, the contact pressure on each fiber set will be controlled by the weight of a cross bar.

This metrology will provide NIST with the unique capability of generating model composite systems with controlled and systematically variable fiber architectures in 3-D. This technology will provide the basis for linking micromechanics failure parameters with computational models that can predict the macroscopic failure of composites and aid in the establishment of failure probabilities for composite structures in the automotive and offshore industries.

Contributors and Collaborators

W. McDonough, J. He, E. Feresenbet, J. Dunkers, D. Hunston (Polymers Division, NIST)
L. Phoenix (Cornell University), J. Nairn (University of Utah)

Structure-Property Characterization and Modeling

Donald Hunston, Charles Han

To remain competitive internationally, industries as diverse as transportation, infrastructure, aerospace, and off-shore oil require the ability to engineer lightweight composites and structural polymers to achieve advanced properties. The key technology is the ability to predict behavior from the material's microstructure since that structure controls performance. This project focuses on the role of microstructure in properties important to industry and formulates advanced micromechanics models that will enable optimization of properties for a material through control of its microstructure.

This project includes a variety of engineered polymers and polymeric systems, but the current focus is hybrid composites that are polymers reinforced with two or more different types of fibers. By combining the advantageous features of different fibers, industry can achieve significantly better trade-offs between various properties and between cost and performance. Unfortunately, the design methodology for hybrids is inadequate. Different test methods often give different values for the same property and current theories for predicting behavior are unreliable. The problem is that the failure modes and the interpretation of test results depend on details of the sample microstructure in ways that we do not understand. Moreover, characterizing this microstructure is a challenge since the available tools have not been developed nor adapted to these types of systems.

This program uses model hybrid materials to develop techniques for characterizing sample microstructure. Samples with known microstructure are then tested in multi-axial loading to determine properties. The University of Houston is collaborating in this effort by conducting tests on large specimens while NIST is characterizing small-scale samples. Based on these results, new models are being developed which utilize the detailed microstructure and micromechanics to predict performance.

The initial focus in the program is filament wound hybrids (glass and carbon fibers) that are of interest to the off-shore oil industry. The studies have emphasized transverse shear behavior since that is critical for buckling failure. Not only failure behavior but also modulus has been difficult to determine and predict. For example, data from tests on tubes and plates do not agree. With plate samples the test involves the Iosipescu specimen (see figure). During the past year, this specimen has been analyzed and several important problems have been identified. The area of the specimen that is important for the test is a small region between the two notches where the shear stress field exists. To obtain valid results, this region must be large enough to encompass the details of the microstructure that can be in the mm size scale for hybrid composites. On the other hand, the strain gage used in the test must be small enough to fit within this region. Detailed experiments and finite element analyses

were conducted to determine these size limits for hybrids. This result is very important for industry since the alternative to the Iosipescu test is experiments on torsion of tubes that requires expensive equipment and samples.

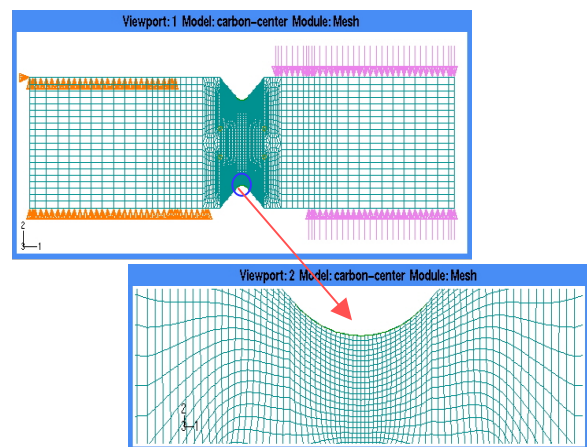

Finite element mesh for analysis of Iosipescu specimen

A second development in this program was the extension of current ASTM burn-off tests for constituent content to include hybrid composites. This work has demonstrated that the NIST modified test method provides a simple and inexpensive way for industry to determine the content of glass fibers, carbon fibers, resin, and voids in a sample. Such information is critical for analyzes such as that described above or for the prediction of properties. Although some work remains to verify the accuracy with which the contents can be determined, it is expected that a finalized version of the modification can be submitted next year to ASTM for consideration.

A third accomplishment in the program involves prediction of dynamic behavior for tube structures made with hybrid composites and that is described elsewhere in this report. The work to date has focused on stiffness properties of the hybrids and has had good success in resolving many of the questions that existed. Next year, the focus will turn to failure behavior.

Contributors and Collaborators

D. Hunston, W. McDonough, M. Chiang, F. Phelan, G. Holmes, S. Glotzer, J. He, N. Parekh (Polymers Division, NIST)
 S.S. Wang, G. Williams (University of Houston)
 D. Johnson (Lincoln Composites)

Modification of the Phase Stability of Polymer Blends by Filler Additives

Alamgir Karim, Alan Nakatani

Polymeric materials are often modified with additives that alter processability, modulus, impact strength, conductivity, and other properties. These multiphase mixtures are often unstable over long periods of time, leading to property degradation. Controlling the phase boundary of these dispersions has practical importance because the temperature difference from the phase boundary (quench depth) is a primary factor governing the stability of these mixtures. The influence of filler on the phase stability of a model polymer blend is investigated.

Building on earlier work on phase separation in bulk polymer materials, the effect of filler additives on phase separation was studied by adding fumed silica particles to a model polymer blend. The surface properties of the filler particles were modified to determine how this factor influenced the phase boundary shifts. We find that filler additives can shift the phase boundary and that the effect is dependent on the polymer-surface interaction and the filler concentration.

Cloud point measurements were performed on model blends of polystyrene (PS) and polybutadiene (PB) with fumed silica particle additives that were subjected to different surface treatments. Cloud points were measured by placing mechanically mixed filled blends on a microscope slide positioned on a temperature-controlled hot-stage and monitoring scattered light intensity (Fig. 1).

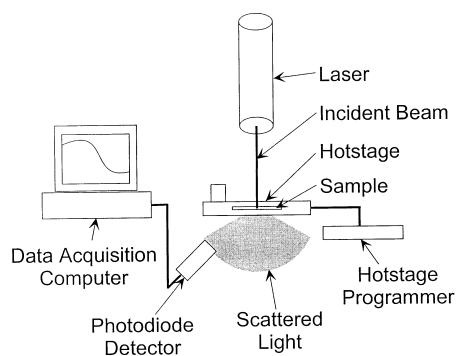

Figure 1. Schematic of experimental apparatus

Fig. 2 shows the cloud point curve for filled and unfilled PS/PB blends. The filled blend data correspond to mass fractions of (1 and 5) % fumed silica particles without surface treatment. The filler particles lead to a decrease of the blend miscibility; there is little change in the critical composition of the filled blend. The shift of the critical temperature increases with the filler content. Cloud-point measurements were insensitive to the period of mechanical mixing between the blend and the filler in the compounder.

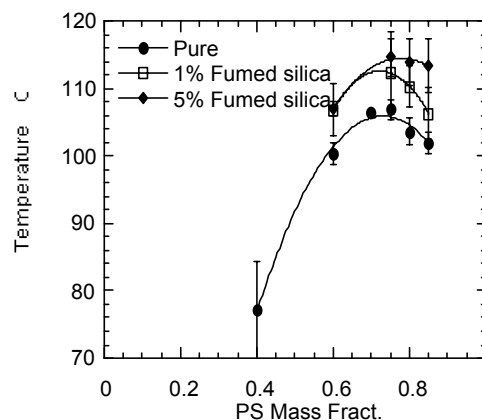

Figure 2. Temperature (°C) versus relative PS Mass Fraction; error bars represent standard uncertainty.

The critical point for phase separation can be shifted up or down through the addition of additives that have a varying relative affinity for the blend components; these effects have been investigated to a limited extent theoretically. Grafting polystyrene chains on the surface of the filler particles led to a slight decrease of the cloud point while treatment by the silane coupling agent (BMDMCS) led to a substantial downward shift of the phase boundary (Fig. 3), in qualitative accord with theory.

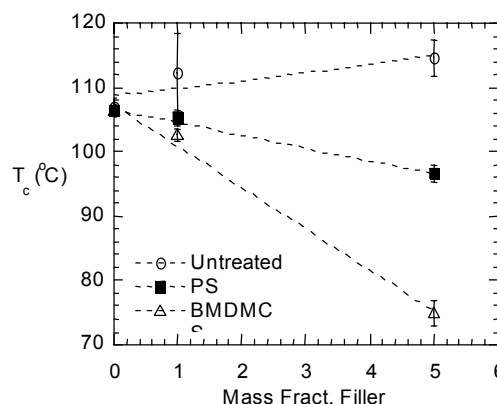

Figure 3. Cloud point Temperature (°C) versus relative filler mass fraction

Contributors and Collaborators

A. Karim, A. Nakatani, J. Douglas, D.-W. Liu (Polymers Division, NIST)
J. de Groot (Dow-Corning)

Nanofiller-Induced Suppression of Dewetting in Thin Polymer Films

Alamgir Karim, Jack F. Douglas

The effect of a model nano-particle fillers [buckminsterfullerene, C_{60} , or/and “buckyballs” (BB), silica beads] on the dewetting of polymer films on inorganic substrates was investigated. The BB and silica filler particles strongly suppressed the dewetting of the thin polymer films, in contrast to larger filler particles that promoted dewetting by heterogeneous nucleation. Recently, we have shown that the suppressed dewetting also occurs for silica nanofillers and for lipid films containing membrane proteins, so the effect has some generality.

Optical images (shown in the figure below) of 50 nm thick a) polystyrene (PS) and b) polybutadiene (PB) films spun cast onto Si wafers show ordinary dewetting at annealing temperatures above their glass transition. Corresponding films of c) PS and d) PB at the same thickness and under the same annealing conditions with 1% BB (ϕ , mass fraction of BB) show a strong suppression of dewetting. Atomic force microscopy images of thinner films (20 nm) showed pinhole defects that are not apparent in optical images for BB concentrations below 0.5%.

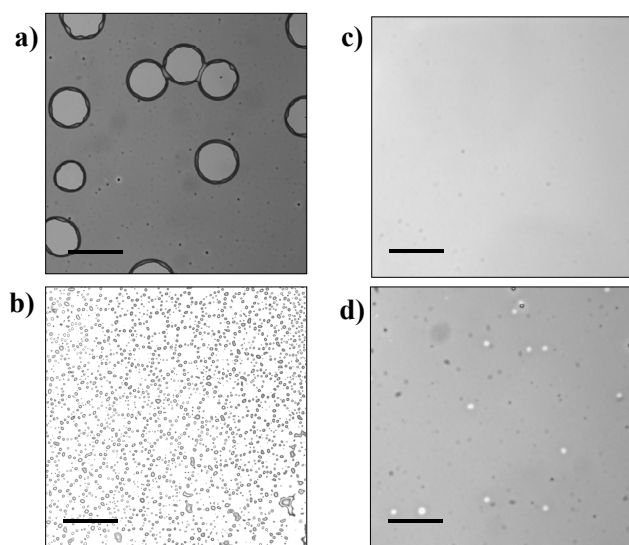

Thin films are increasingly used in applications involving dielectric coatings, resist layers for lithography, electronic packaging, optical coatings, lubricating surfaces, etc. Producing stable and defect-free films is particularly problematic in very thin films (thickness, $h < 10$ nm) where thermally induced fluctuations at the air surface induce the film to rupture. We demonstrate that it is possible to suppress the dewetting of thin polymer films through the introduction of nanoparticle additives.

Neutron reflectivity (NR) measurements of a 100 nm PS film with 5% BB indicate a diffuse layer of BB at the Si substrate formed during spin casting. There is no evidence from NR or contact angle measurements that the BB segregate to the air surface.

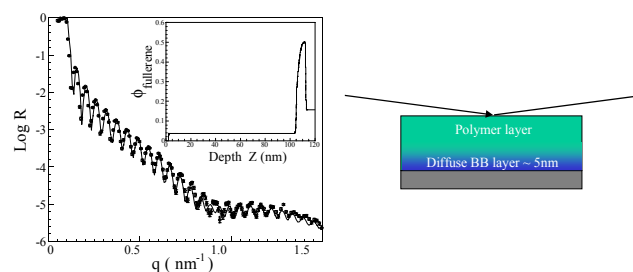

The presence of BB at the substrate apparently pins the polymer dewetting contact line, implying a dependence on BB concentration. This is confirmed experimentally. Films without the BB filler form holes that grow and coalesce to reach complete dewetting. Films with small amounts (0.01% and 0.1%) of BB show hole formation without hole growth. As the BB concentration is increased further, the hole size diminishes below the limits of optical and AFM observation.

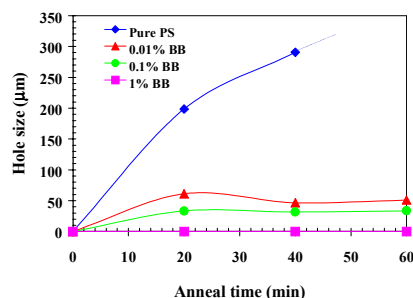

The key feature of the suppressed dewetting appears to be the immobilization of the filler and the nanoscale size of the filler. The BB layer at the substrate surface is diffuse and pins the contact line of dewetting holes at an early stage. The extent of dewetting is controlled by the amount of BB in the range $0 < \phi_{\text{filler}} < 0.01$. For $\phi_{\text{filler}} > 0.01$ there is complete suppression of holes in $L < 50$ nm films.

**Contributors
and
Collaborators**

A. Karim, J. F. Douglas, A. I. Nakatani, D.-W. Liu (Polymers Division, NIST)
K. A. Barnes (Dow-Corning)

Polymer Characterization

The Polymer Characterization Program provides measurement methods, data and standard reference materials (SRMs) needed by U.S. industry, research laboratories, and other federal agencies to characterize rheological and mechanical properties of polymers, their processibility and performance, and to improve process control. In response to the critical needs of industry for in-situ measurement methodologies, a substantial effort is underway to develop optical, dielectric and ultrasonic probes for use in extrusion and injection molding. Improved methods for determining molecular mass distribution of polymers are developed owing to the dramatic effect it has on processibility and properties. Mechanical properties and performance are significantly affected by the solid-state structure formed during processing. Importantly, unlike many other common engineering materials, polymers exhibit mechanical properties with time dependent viscoelastic behaviors. As a result, the program also focuses on techniques that measure the solid-state structure and rheological behavior of polymeric materials.

Chromatographic techniques, which require calibration by standards of known molecular mass, are the principal methods for determining molecular mass distribution. Because calibration standards are lacking for most polymers, crude approximations must be used to interpret chromatographic data. Recent program activities exploit advances in mass spectrometry using matrix assisted laser desorption ionization (MALDI) to develop the method as a primary tool for the determination of the molecular masses of synthetic polymers, with particular emphasis on commercially important polyolefins. Advances are sought in measurements of solid-state structure of polymers, including optical coherent tomography (OCT), inelastic neutron scattering, and sum frequency generation spectroscopy.

The extrusion visualization facility combines in-line microscopy and light scattering for the study of polymer blends, extrusion instabilities and the action of additives. Current research focuses on understanding and controlling the "sharkskin instability" in polymer extrusion. Fluorescence techniques are developed to measure critical process parameters, such as polymer temperature and orientation that were hitherto inaccessible. These measurements are carried out in close collaboration with interested industrial partners.

The polymer industry and standards organizations assist in the identification of current needs for standard reference materials. Based on these needs, research on characterization methods and measurements are conducted leading to the certification of standard reference materials. Molecular standards are used primarily for calibration of gel permeation chromatographs, the principal method employed by industry for assessing molecular mass and molecular mass distributions. Melt flow standards are used in the calibration of instruments used to determine processing conditions for thermoplastics. Non-Newtonian rheological standards are also developed to exhibit the typical polymeric behaviors of shear thinning and normal stresses; these standards are also used for calibration of rheological instruments and for research into improved measurement methods. Reference biomaterials are produced for test method harmonization, assessment of new materials and generation of reference data.

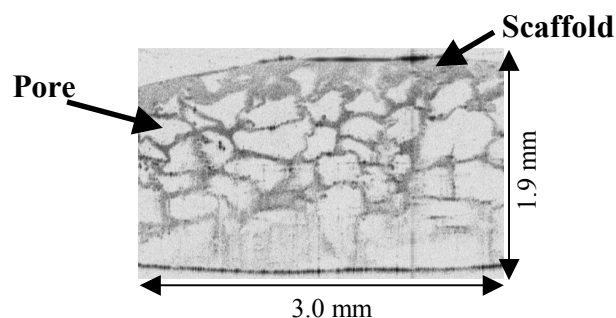

OCT cross-sectional image of a hydrogel tissue scaffold.

Contact Information: Bruno Fanconi

Optical Coherence Tomography for Material Characterization

Joy P. Dunkers

The need for non-destructive, subsurface microstructural characterization of materials in the micrometer to millimeter size scale is great. A volumetric representation of the internal structure of a material is often required to understand how various properties of interest are interrelated. NIST has brought optical coherence tomography (OCT) to the realm of material science. We are using OCT for meso-scale, volumetric characterization that cannot be obtained by any other technique and are applying it to polymer composites, polymer blends, biomaterials, and ceramic coatings.

Optical coherence tomography (OCT) is a non-invasive, non-contact optical imaging technique that allows the visualization of microstructure within scattering materials. OCT uses a near-infrared low coherence source and a scanning fiber optic interferometer for depth discrimination. Reflections generated from material heterogeneity are collected as a function of depth. Transverse scanning in the remaining two planes by motorized stages generates the volumetric image. OCT is a high sensitivity technique that can detect back-reflections as low as femtowatts with a resolution of (5 to 30) μm .

This past year we constructed a table-top OCT system with a reference mirror capable of scanning a maximum of 7.5 mm. The actual depth within the sample is the distance traveled by the reference mirror divided by the group refractive index of the sample. The system has three motorized stages, each with 10 cm of travel. The sample rests on two of the three stages that scan in perpendicular directions to create a volumetric image set. The third stage is used to adjust the focus of the beam onto the sample. The resolution of the system is 15 μm in the thickness direction (z axis) and (5 to 100) μm in the transverse directions (x and y axes), depending upon choice of objective. The system possesses a sensitivity of >110 dB.

To evaluate the potential of OCT we compared it to micro-focus x-ray computed tomography (x-ray CAT), the only other technique that is non-destructive and yields volumetric images of resolution similar to OCT. The comparison was performed on a selected region of impact damage in a glass-reinforced thermoset composite. OCT revealed the reinforcement architecture and damage with 10 μm to 20 μm spatial resolution. Several damage mechanisms were found and were identified to be kink banding, fiber/matrix debonding, longitudinal cracking, and matrix deformation. All of these mechanisms were consistent with damage expected from bending a composite with a tough matrix and poor fiber-matrix bonding. The limitations of OCT were that the fiber architecture was not imaged clearly throughout the entire specimen thickness. The images were subject to artifacts such as shadowing, contrast degradation as a function of thickness, and degradation of spatial resolution.

X-ray CAT clearly imaged the tow stacking throughout the entire sample but was insensitive to the stitching. Owing to sensitivity and resolution limitations, the fiber/matrix debonding and kink-band damage were seen together as one barely visible region. The matrix deformation shown by OCT was not visible. OCT provided superior sensitivity and resolution in this analysis.

OCT has been historically used for medical imaging. NIST is bridging the gap between materials science and medicine by using OCT to non-destructively elucidate the meso-scale structure of biomaterials. An important consideration with biomaterials is working in aqueous medium to mimic their natural state. OCT is able to image biomaterials *in-situ*.

A tissue scaffold is a substrate upon which cells are grown in order to generate a living tissue with a specific function. Most tissue scaffolds are porous to allow for cell migration and proliferation. Characterization of the scaffold porosity is one important aspect in evaluating scaffold viability. An OCT cross-sectional image of a hydrogel tissue scaffold in water is shown below. The light gray areas are the water filled pores and the darker gray areas are the scaffold material. Note that the microstructure seen by OCT is significantly different than what would be seen in a dehydrated sample prepared for scanning electron microscopy. OCT can generate volumetric information on average pore size, size distribution, and connectivity.

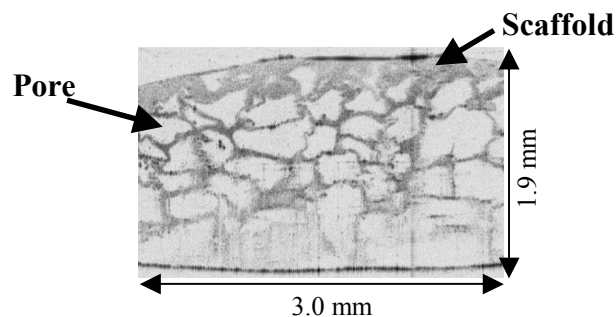

OCT cross-sectional image of a hydrogel tissue scaffold.

Contributors and Collaborators

J. Dunkers, C. Simon, N. Washburn (Polymers Division, NIST)
 J. Chuang (Ceramics Division, NIST)
 M. Everett (Livermore National Laboratory), P. Davis (Optiphase, Inc.),
 J. Kohn (Rutgers University), W. Green (Army Research Laboratory)

Advanced Metrology for Surface and Interface Chemical Analysis

William Wallace

The chemical structure at both the free surface and buried interfaces of polymeric materials is often critical to their performance as it can control such properties as adhesion and wear. Molecular characterization of these interfaces is difficult: conventional surface science probes often do not have the specificity to broadly characterize complex chemical moieties. We have explored three cutting-edge techniques to surmount this long-standing challenge: vibrationally-resonant sum-frequency generation, cluster-beam secondary ion mass spectrometry, and near-edge x-ray absorption fine structure.

Vibrationally-resonant sum-frequency generation is a non-linear optical technique in which an infrared photon and a visible photon are mixed to produce a new photon at the sum frequency. It has all the advantages of linear vibrational spectroscopies, and the additional characteristic that it is symmetry forbidden in amorphous and centrosymmetric media. Thus it is uniquely interface sensitive. We have made the first measurements of the *absolute* molecular orientational distribution of a pendant side group at a polymer surface. At the polystyrene/air interface, the pendant phenyl groups are oriented away from the film and tilted from the surface normal in an angular range near 60°. The phenyl groups are suggested to point outward either as a means to seek the maximum free volume, or possibly as the lowest free energy conformation that smoothes out the abrupt change in density due to the presence of the free surface.

Cluster-beam secondary ion mass spectrometry uses polyatomic incident ions (e.g., SF₅⁺) to improve secondary ion yield for increased surface sensitivity and also for improved depth resolution for more precise thin film profiling. This has resulted in a better than *ten fold* increase in the secondary ion yield of poly (methyl methacrylate) samples while the damage depth stays on the same order as the sputter region. This gives much improved surface sensitivity. Future work will focus on quantifying the improvement of depth resolution using multilayer samples.

Carbon near-edge x-ray absorption fine structure was used to detect both surface and bulk segmental relaxation in uniaxially-deformed polystyrene samples. We have demonstrated that by simultaneously monitoring the partial electron yield (kinetic energy > 150 eV) and the fluorescence yield (carbon K_α 277 eV) NEXAFS signals, with probing depths of approximately 2 nm and 200 nm, respectively, one can, in a single experiment, examine segmental motion throughout a polymer sample. Using this methodology, *chain relaxation is found to occur almost 50% faster at the surface than in the bulk*. This finding is expected to profoundly influence the design, processing, and application of all polymeric materials.

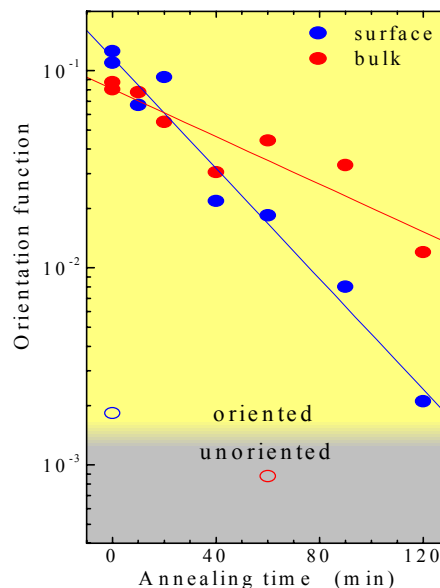

Figure: Time evolution of the orientation factor, OF, from an elongated (oriented) polystyrene sample reveals that when annealed at 60 °C the surface chains relax to an equilibrium (unoriented) configuration faster than the bulk chains. OF is calculated from $(I_{\parallel} - I_{\perp}) / (I_{\parallel} + I_{\perp})$, where I_{\parallel} and I_{\perp} are the $1s \rightarrow \pi_1^*$ resonance NEXAFS intensities collected with the sample elongation direction parallel ($\phi = 0^\circ$) and perpendicular ($\phi = 90^\circ$) to the electric vector of the soft X-ray beam, respectively. The blue circles denote OF from the partial electron yield NEXAFS signal (surface region) and the red circles represent the fluorescence yield NEXAFS signal (bulk region), measured simultaneously. The closed and open circles depict OF evaluated from data collected on elongated specimens and those not subjected to elongation, respectively. The solid lines represent exponential decay fits to the experimental data on the elongated samples.

Contributors and Collaborators

W. Wallace, W. Wu (Polymers Division, NIST), D. Fischer (Ceramics Division, NIST), L. Richter, G. Gillen (Surface & Microanalysis Science Division, NIST) K. Briggman, J. Stephenson (Optical Technology Division, NIST) Luke Haney (U. Ill.-Chicago) Jan Genzer (NC State)

Molecular Mass Distribution of Polymers by Mass Spectrometry

Bruno Fanconi, Charles Guttman

The molecular mass distribution (MMD) of a polymer has profound effects on how it is processed and the resultant properties. Recent advances in Matrix Assisted Laser Desorption Ionization (MALDI) Time of Flight (TOF) Mass Spectroscopy (MS) suggest that it is possible to obtain the MMD of undegraded polymer molecules with molecular masses up to 300,000 g/mol. MALDI is explored as a method to obtain the measurement of the absolute molecular mass of a polymer molecule, as well as a tool to obtain the molecular architecture of a polymer.

Interlaboratory Comparison Using MALDI TOF MS

With the objective of providing the polymer industry with a measure of the robustness of the MALDI ToF MS method to obtain the MMD of a synthetic polymer, the NIST Polymers Division, in cooperation with the American Society of Mass Spectrometry (ASMS) Working Group on Synthetic Polymers, conducted an interlaboratory comparison of MALDI ToF MS. Samples of well-characterized low molecular mass polystyrene were sent to any institution requesting it.

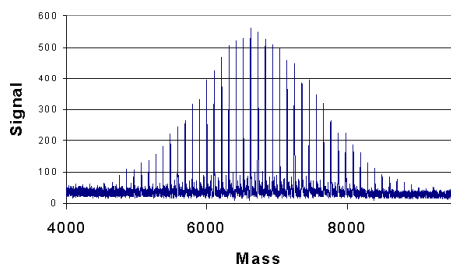

A total of 23 institutions participated in the interlaboratory comparison (10 industrial, 9 academic, and 4 government laboratories). NIST Polymers Division also characterized the polymer by NMR for M_n and by light scattering for M_w . Fourier transform infrared spectroscopy, FTIR, confirmed the presence of the t-butyl end group, as anticipated by the synthesis method. Size exclusion chromatography was used to insure vial-to-vial homogeneity in the samples distributed to participants. Each participating laboratory was asked to perform MALDI mass spectrometry using two distinct protocols.

By compiling all the returned data using both protocols into one analysis it was found that MALDI ToF MS returned an M_n of (6610 ± 100) g/mole and an M_w of (6740 ± 90) g/mole, uncertainties are standard uncertainties. These numbers were below those of the classical methods, but still within the overlapping uncertainty ranges. Detailed results of this study have been submitted for publication to Analytical Chemistry. The intent is to certify the polymer used in this study as a Standard Reference Material SRM 2888.

Polymer Architecture of Polysilsesquioxanes

Polysilsesquioxanes are used in industry as an alternative to siloxanes in applications where strength, thermal stability, or chemical resistance are at a premium. Polysilsesquioxanes are three-dimensional polymers with a repeat unit of the form $[RSiO_{3/2}]$ in which each silicon atom is coordinated with three oxygen atoms.

One important unknown in the processing of silsesquioxanes is the “degree-of-condensation” of the prepolymer before it is converted into the final monolith. The prepolymers of the polysilsesquioxanes were studied by MALDI ToF MS by the NIST Polymers Division. In all cases the number of intramolecular Si-O-Si bridges per oligomer was found to be a linear function of the number of repeat units in the oligomer. It is not possible to obtain this result by other measurement techniques like NMR or FTIR.

This work led to a CRADA with Dow Corning. NIST provided the measurement expertise in MALDI ToF MS of silsesquioxanes (SSQ) and Dow Corning provided the siloxane-SSQ copolymers of commercial interest. Dow Corning also performed extensive fractionation in order to narrow the broad molecular mass distribution in an effort to facilitate the mass spectrometry. The MALDI ToF MS data obtained when analyzed by special data analysis techniques NIST had developed led to the discovery of quite surprising results that the SSQ monomers appear in even numbers in this copolymer.

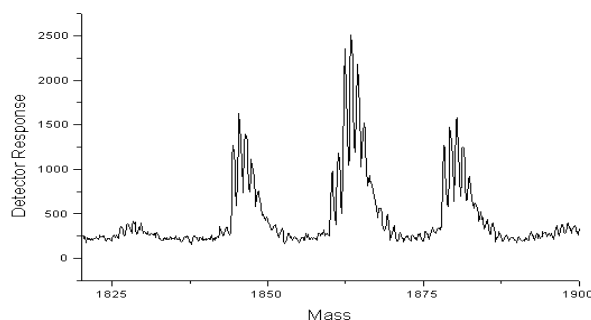

Contributors and Collaborators

C. Guttman, W. Blair, R. Goldschmidt, W. Wallace, B. Fanconi, J. Antonucci, (Polymers Division, NIST)
 S. Wetzel (Department of Chemistry, American University)
 D. Katsoulis, R. Techlenberg (DowCorning)

Standard Test Method Development

Charles Guttman, Bruno Fanconi

The U.S. polymer industry routinely characterizes its products, their processibility and performance with test methods that while convenient, require calibration by known standards. Principal polymer standards are certified for molecular mass and melt flow rate; the former is used to calibrate size exclusion chromatographs and the latter to calibrate melt flow indexers. Quantification of mass spectrometry as a method for determination of molecular mass distribution is undertaken as the basis for development of a standard method for analysis of synthetic polymers.

With recent advances in mass spectrometry it is possible to measure the molecular mass of some biological and synthetic polymers. Among the advances is a variation of time-of-flight mass spectrometry, ToF MS, matrix assisted laser desorption ionization, MALDI, in which laser ablation is used to produce charged polymers in the vapor state. This technique has the potential to be an absolute method for measuring the molecular mass distribution (MMD) of synthetic polymers, a long sought after goal in polymer characterization. The mass distribution of a synthetic polymer is the most important molecular characteristic that impacts its processibility and macroscopic properties. There are no other methods of determining this important molecular characteristic of synthetic polymers, although separation techniques, such as gel permeation chromatography, provide relative measures of MMD and other techniques yield average values of the MMD. However, chromatographic instruments must be calibrated with polymer standards that have narrow MMD and are similar chemically to the polymer being tested. These polymer standards are certified for averages of the molecular mass distribution by classical methods (light scattering, membrane osmometry, sedimentation equilibrium ultracentrifugation). Since such standards are unavailable for most polymers, crude approximations are used which introduce uncertainties in the measurement results.

Reported comparisons of MMD by MALDI ToF MS with data obtained by classical methods reveal unsettling discrepancies that must be resolved before the method is accepted. To address the need for quantification of MALDI ToF MS we have initiated, with the collaboration of laboratories in Canada, Japan, Germany and Italy, a technical working activity under the auspices of VAMAS, the Versailles Project on Advanced Materials and Standards. The VAMAS activity will investigate the effects of sample composition & preparation, instrument settings and data analysis on the quantitiveness of MALDI ToF MS spectroscopy.

The initial focus is to develop a standard test method for determination of the MMD of polystyrene by this method. Polystyrene was selected owing to the availability of essentially mono-dispersed commercial samples, the success to which MALDI MS data can be obtained and results of the recent NIST led interlaboratory comparison of PS using MALDI ToF MS that laid the basis for quantification studies. The specific objectives are:

- 1) Sample composition and preparation method, including recommended matrix materials, metal salts, solvents, mixture concentrations and sample deposition procedure. The SEM in the figure below is from a sample deposited by electrospray.
- 2) A set of guidelines for MALDI-ToF-MS to obtain instrument settings and mass calibration.
- 3) Procedures and guidelines for analyzing mass spectral data.

An ancillary output is polystyrene reference materials certified for molecular mass distribution and averages of the molecular mass distributions for testing MALDI ToF MS instruments and procedures.

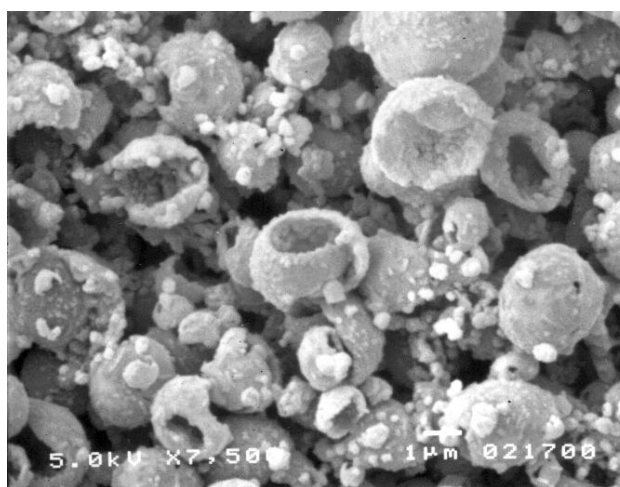

Contributors and Collaborators

S. Wetzel (Department of Chemistry, American University)
 S. Weidner (Bundesanstalt für Materialforschung und -prüfung, Germany)
 S. Kinugasa (National Institute of Materials and Chemical Research, Japan)
 G. Montaudo (University of Catania, Italy)
 L. Li (University of Alberta, Canada)

Non-Newtonian Standard Reference Materials for Rheology

Carl Schultheisz

Characterization of the flow behavior of polymeric fluids is critical to efficient processing. Polymeric fluids typically demonstrate complex, non-Newtonian fluid flow behavior, such as a viscosity that depends on shear rate and normal stresses. The viscoelastic behavior of two polymeric fluids (a polymer solution and a polymer melt) will be characterized in steady and dynamic shear over a temperature range from 0 °C to 50 °C. These fluids will serve as benchmarks to compare the performance of rheometers in situations involving complex fluids.

Polymer melts and solutions typically do not follow the simple Newtonian ideal in their flow behavior, demonstrating shear-rate dependent viscosities and normal stresses. Such fluids see wide application in everyday life (injection molding, paints and coatings, food products, etc.), and the ability to accurately measure and characterize their behavior is very important to optimizing their processing conditions. Since there are a number of commonly used methods to measure the flow behavior of polymers, the new Standard Reference Materials (SRM 2490 and SRM 2491) will provide a way for comparing the performance of different instruments, as well as providing tools for research into better methods of measuring the rheological properties of polymeric fluids. The new fluids will be certified for the shear-rate dependence of viscosity and first normal stress difference at temperatures of 0 °C, 25 °C and 50 °C. The linear viscoelastic responses will also be certified along with the temperature dependence of the shift factors over the same temperature range.

The new polymer solution, SRM 2490, consists of polyisobutylene (molar mass approximately 10^6 g/mol) dissolved in 2,6,10,14-tetramethylpentadecane. The branched structure of this solvent inhibits crystallization or vitrification down to at least -60 °C, while the relatively high molar mass of the solvent reduces its rate of evaporation. Cannon Instruments mixed and packaged 438 units, 100 mL each. Measurements of SRM 2490 in steady and dynamic shear have been completed; results from steady shear testing are shown in the accompanying figures. Twenty samples were tested at each temperature, using cone and plate fixtures in a strain-controlled rheometer.

SRM 2491 will consist of a poly(dimethylsiloxane) melt. This fluid will have somewhat less temperature dependence than the solution SRM 2490.

This project will also include a round robin test of the Standard Reference Materials among instrument manufacturers and users in industry and at universities. The round robin will investigate the lab-to-lab variability in these measurements; the variability in the first normal stress difference is of particular interest.

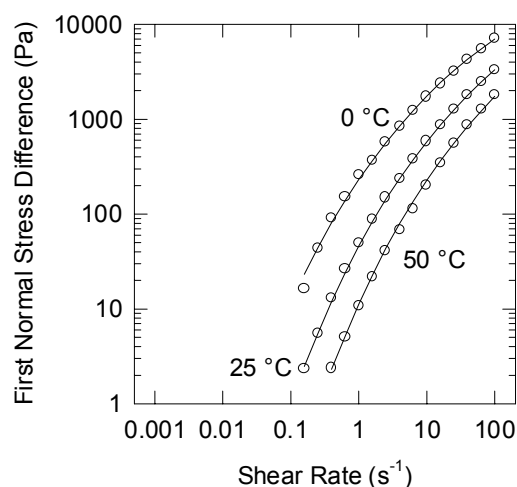
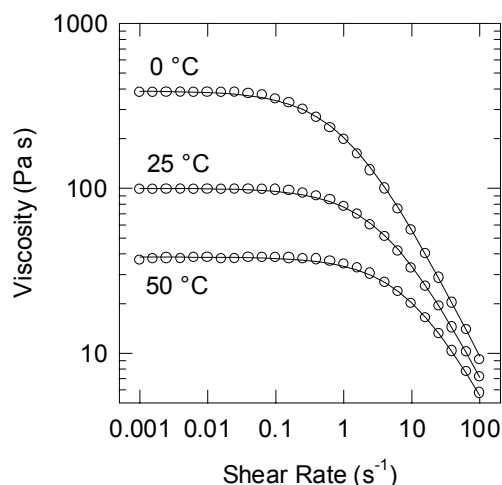

Viscosity and First Normal Stress Difference in Steady Shear. Symbols are measured quantities; lines are models that incorporate time-temperature superposition fit through all the data simultaneously.

Contributors and Collaborators

S. Leigh (Statistical Engineering Division, NIST)
 G. McKenna (Texas Tech University)
 Cannon Instruments, State College, Pennsylvania

Support for the Biomaterials Integrated Products Industries

John A. Tesk

NIST workshops have established that the medical devices industry has needs for reference materials, test methods, and reference data. This project is established to continually assess NIST ability to help meet technical needs of BIPI's. In addition to workshops, needs are explored through participation on numerous standards boards and their committees, on committees/boards of professional societies and academic institutions, and via liaisons with the National Institutes of Health and the Food and Drug Administration.

A series of NIST workshops, with participation of the Biomaterials Integrated Products Industries, BIPI's, established needs for measurement methodology, reference biomaterials and reference data. NIST responded to the need for an accelerated, wear-test method for the screening of new materials for orthopaedic joint implants through formation of the Orthopedics Research Consortium. At a Reference Materials, RM, Workshop in 1998, the need for a RM of medical grade ultra high molecular weight polyethylene, MG-UHMWPE, bar stock was identified for replacing the dwindling supply that had been made available for orthopaedic research by the Hospital for Special Surgery. NIST issued a replacement RM in October 2000. That workshop also identified the need for a RM of MG-UHMWPE reference material, wear-debris particulate. On July 27, 2000, a workshop was held to explore the potential of need for a Standard Biomaterials Properties Reference Database (SBPRD). Participation on committees/boards of standards organizations, professional and academic organizations, and the NIH (member of Steering Committee for NIH produced workshop on Implant Retrieval and Analysis, Jan 10-12, 2000) helped further toward understanding of BIPI needs and for establishing useful relationships. Publications were also pursued to provide greater visibility of NIST to the BIPI's community.

The development of a method to produce MG-UHMWPE wear debris particulate is in progress under the direction of Dr. Steve Hsu of the NIST Ceramics Division.

The workshop on Standard Biomaterials Properties Reference Data identified the need for several databases and for RMs for ophthalmic, orthopaedic, dental, cardiovascular, and tissue-engineered materials.

Active participation in ASTM assists in meeting needs of BIPI's in standards and test methods. A new method for determination of degree of cross-linking in irradiated UHMWPE is under final evaluation through round robin testing. Interest in irradiated MG-UHMWPE stems from the positive effect on wear resistance. A better method of determining the molecular response to irradiation will assist in optimization of the process.

NIST assisted in the round robin by providing cubes of its new reference material MG-UHMWPE for use in the round robin. These samples will be irradiated at several doses and distributed to laboratories for measurement of degree of cross-linking using the draft method. Supporting the interest in radiation treatment of MG-UHMWPE, NIST will make the cubes available for purchase as a RM for comparison purposes.

Progress on the development of ophthalmic RMs involves collaboration among NIST, Louisiana State University, Alcon Industries and NIH. The need for specific RMs and ancillary reference data have been established through the collaboration.

NIST Materials Science and Engineering Laboratory is becoming recognized as an integral part of biomaterials standards, test methods, and research community (beyond the dental community). NIST participation in development of standards and reference materials is sought and is looked to for playing a key role in coordination of such efforts.

Contributors and Collaborators

J. Tesk, F. Eichmiller (Polymers Division, NIST); S. Hsu (Ceramics Division, NIST); J. Colbert, J. Thomas (Standard Reference Materials Program, NIST); J. Rumble, J. Fuller (Standard Reference Data Program, NIST); NIH; FDA; Biomet; Depuy, a J&J Company; Stryker Howmedica Osteonics and Zimmer; Polymer Technology Group; Alcon Industries; Genzyme; Poly Hi Solidur

Semicrystalline Polymer Structure by Small Angle Scattering

John Barnes

Processors and users of products formed from semicrystalline polymers need improved descriptors of microstructural characteristics in order to control properties of their materials. The method of temperature-induced contrast variation as pioneered in this project provides a means of separating the lamellar stack microstructure from voids and other matrix effects, thereby affording improved identification of mechanisms that influence properties such as toughness, modulus, clarity, and permeability.

In 1999 we demonstrated [1] that the variation in scattering contrast arising from differences in thermal expansion between the amorphous and crystalline components of semicrystalline thermoplastic materials could be used to sort out multiple contributions to the small-angle scattering from these materials. We refer to this as temperature-induced contrast variation (TICV). In calendar year 2000 the SANS part of this work was extended to cover a broader temperature range. Complementary WAXD and SAXS studies were undertaken on anisotropic semicrystalline polyolefin samples in order to characterize the three-dimensional character of the scattering from these materials.

Figure 1 depicts part of the data from this study. The high-density polyethylene sample was prepared from a shotgun shell casing that is often used as a reference for orientation texture studies. The poly(4-methyl-1-pentene) sample (P4MP) was prepared by subjecting compression molded plaques to channel die extrusion at a temperature just below their crystallization temperature. In both instances the resulting sample symmetry is strongly orthorhombic, as is shown in the SAXS patterns in figure 1.

These patterns were obtained at the Exxon/Mobil beamline (X10A) at the National Synchrotron Light Source. Each specimen was in the form of a rectangular prism with the flow direction oriented along the long axis of the specimen, which is the vertical axis in Figure 1. The SAXS patterns are sections through the 3-d intensity distribution and were collected at fixed angles of 0, 30, 60, 90, ... 360°. The WAXD patterns were obtained by integrating the scattered intensity over the full 30° rotation step.

WAXD data were collected only at room temperature, while SAXS data were collected over a range of temperatures far enough below the melting point to avoid significant morphological change. The P4MP SAXS patterns in Figure 1 were collected at 145 °C. The corresponding patterns were basically invisible at temperatures below 65 °C, in keeping with our earlier observations on the very strong TICV effect in this polymer.

The lack of suitable basis functions for the anisotropic form factor of the lamellar stack represents a further challenge to the interpretation of these data.

The continuation of this work involves transferring the necessary data collection protocols and data reduction software into Small Angle Scattering (SAS) beam lines at other active SAS centers, so that the method can be applied to a broader range of polymer products.

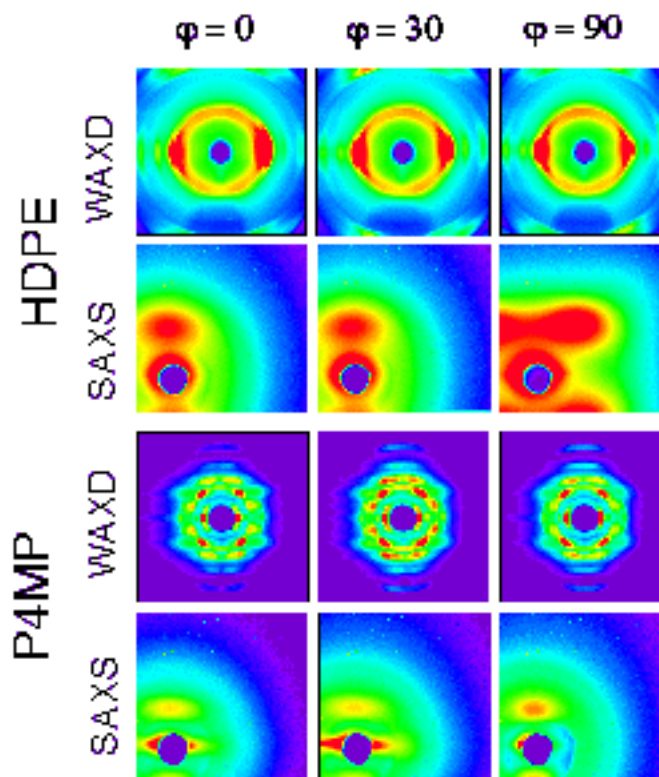

Figure 1: WAXD and SAXS from two highly oriented polyolefin specimens as a function of specimen orientation.

1. J.D. Barnes, R. Kolb, K. Barnes, A.I. Nakatani and B. Hammouda, *J. Appl. Cryst.*, (2000). v33, pp758–762.

**Contributors
and
Collaborators**

J. D. Barnes (Polymers Division, NIST)
R. Kolb (Exxon-Mobil Engineering R & D Ctr.)

Partitioning of Chain Defects in Isotactic Polypropylene

David VanderHart

The intent of this project is to determine experimentally, with supporting computations, the partitioning of various defect structures between the crystalline (CR) and the non-crystalline regions (NC) of isotactic polypropylene (iPP). iPP is a high-volume commercial polymer. Its properties can be modified, mainly by influencing the amount, size and perfection of its crystalline regions through controlling the amount and nature of chain defects. There are a variety of defect structures in commercial iPP's and with the advent of metallocene catalysts, more control can be exercised with respect to the nature and concentrations of such defects.

The defect types we consider are a) the most common stereo defect, the “stereo-mrrm” defect, consisting of one methyl group out of stereoregular order; b) the most common regio defect, the “regio 2,1 erythro” defect, characterized by one monomer being reversed (a head-head followed by a tail-tail polymerization); and c) a comonomer defect where a comonomer (ethylene or butylene) is occasionally substituted for propylene during polymerization.

Primary experimental data comes from solid state ^{13}C NMR in the form of positions and intensities of unique resonances that can be related to the presence of each defect, along with a separation of those signals which originate from the CR regions from those arising from the NC regions of iPP.

Data reduction involves measuring relative intensities for these unique resonances relative to the intensities of the iPP carbons *and* assigning the unique resonances to particular carbons in the defect sites within the CR lattice. To do the latter, “thermal annealing” followed by “energy-minimization” calculations were performed for each defect in the CR lattice. Out of these calculations came candidate bond geometries for the defect chain in the vicinity of the chain defect. Then, *ab initio* chemical shift calculations were performed on a 7-monomer length of the central, defect-containing chain to check calculated shifts against observed. Good fits then support the calculated conformations.

25 MHz ^{13}C spectra associated with the defects in CR regions are shown in Figure 1. A table summarizing the partitioning coefficients (P_{CR} = ratio of CR to overall defect concentrations) as well as approximate conformations near the defects are given in Table 1.

In a semicrystalline, high commodity polymer like isotactic polypropylene (iPP), the presence of chain defects (stereo-, regio-, comonomer-type) can alter mechanical properties significantly, even at mass fractions of 1% to 2%. Properties can be modified, mainly by influencing the amount, size and perfection of its crystalline regions through controlling the amount and nature of chain defects. In this study, we use solid state NMR, computations, and an assortment of iPP's with various dominant defects in order to determine the partitioning coefficients for 4 types of defects.

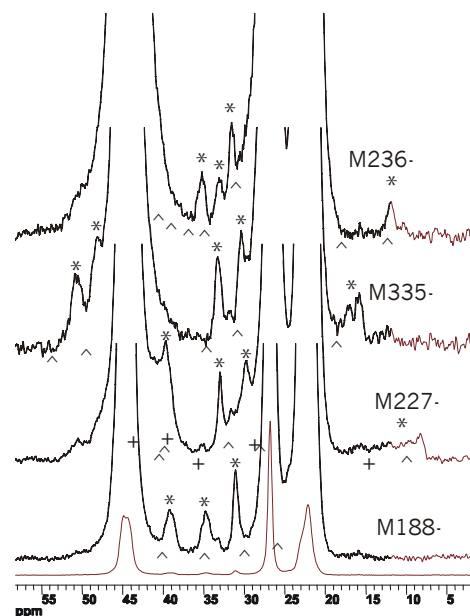

Figure 1: Spectra of the CR regions of the indicated iPP's, each of which is dominated by a different type of defect. From the top down, the dominant defects are: regio-2,1-erythro, stereo-mrrm, butylene-comonomer and ethylene-comonomer. The bottom spectrum is scaled down by a factor of 20. Asterisks appear above each of the defect resonances, which are assigned to each dominant defect. The ‘^’ symbol is placed at the chemical shifts predicted from lattice-energy minimization followed by *ab initio* chemical shift calculations. For the butylene-comonomer sample, both ‘^’ and ‘+’ symbols are used to indicate those calculated values which belong to 2 distinct conformers that we believe to be contributing to the defect spectrum. Main-peak scaling varies in order to highlight defect resonances.

Table 1: Partitioning coefficients, approximate sequence of dihedral angles and our confidence level that the computations have identified the assignment/geometry associated with these 4 Types of defects in crystalline iPP.

Defect Type	P_{CR}^a	Dihedral Angle Sequence (Approximate)	Confidence Level
Regio 2,1 erythro	0.28(8)	(..g ⁺ t g ⁺ t t g ⁺ t..)	Fair
Stereo-mrrm	0.48(6)	(..g ⁺ t t t g ⁺ t g ⁺ t..)	Good
Butylene comonomer	0.52(8)	(..g ⁺ t g ⁺ t g ⁺ t..) &(..g ⁺ t g ⁺ t g ⁺ t..)	Good
Ethylene comonomer	0.40(4)	(..g ⁺ t g ⁺ t g ⁺ t..)	Excellent

a) Standard uncertainties are given in parentheses in units of the least significant digit. Two conformers are populated for the butylene-comonomer defect.

**Contributors
and
Collaborators**

M. Nyden (Fire Science Division, NIST)
R. Alamo (Department of Chemical Engineering, FAMU-FSU, Tallahassee, Florida)

Morphology of Ultra-thin Films of Semi-crystalline Polymers by TEM

Catheryn Jackson

Polymer thin films are widely used in coatings and electronics packaging applications. Measurements of the properties of amorphous thin films have shown that the properties can be significantly different than the bulk material, so development of methods to characterize thin film structure and morphology are vital to utilization of these materials. TEM is ideally suited to study semi-crystalline polymer thin films as it has both high resolution and electron diffraction necessary to determine crystallization properties in the thin film state.

Most studies on ultra-thin films of polymers involve either amorphous polymers or blends of amorphous polymers. We were interested in using TEM to study the structure and morphology of semi-crystalline thin films to determine if crystallization could be suppressed in thin films, thereby forcing a semi-crystalline polymer to remain in the amorphous state. One prior experimental study used Fourier transform infrared spectroscopy to study poly(di-n-hexyl silane) in thin films (C. W. Frank et al., *Science*, **1996**, 273, 912.) and measured the kinetics of crystallization to be much slower below film thicknesses of 20 nm. They also reported that crystallinity vanishes below about 15 nm in this material. Reports on semi-crystalline thin films of poly(ethylene oxide) using atomic force microscopy mostly identify dewetting phenomena coupled with crystallization, under these conditions the thickness of the film is no longer controlled (G. Reiter et al., *J. Chem. Phys.* **2000**, 112, 4376.).

We have studied thin films of *isotactic* polystyrene (*i*-PS) in toluene spin-coated onto carbon coated mica substrates. A series of discrete films of nominal thickness 5 – 60 nm were prepared and then floated off onto TEM grids and studied by electron diffraction and bright-field imaging. The as-cast films show no electron diffraction and are morphologically featureless, indicating that the *i*-PS is amorphous. Upon annealing for 12 h at 180 °C under vacuum, however, crystallization occurs in films greater than 15 nm thick as evidenced by the detection of electron diffraction and the morphologies shown here. Films of thickness less than about 10 nm, however, do not crystallize upon annealing. No evidence of dewetting occurred in any of the amorphous or crystalline films studied and an AFM scratch-tip method (C. Ton-That et al., *Langmuir* **2000**, 16, 2281.) is in use to replace the nominal film thickness estimations with measured values.

The significance of this work is that we have confirmed that a semi-crystalline thin film can be forced into an amorphous state if it is thin enough and dewetting does not occur. In addition, we have shown that TEM is an ideal and powerful method to characterize the structure and morphology of semi-crystalline thin film materials.

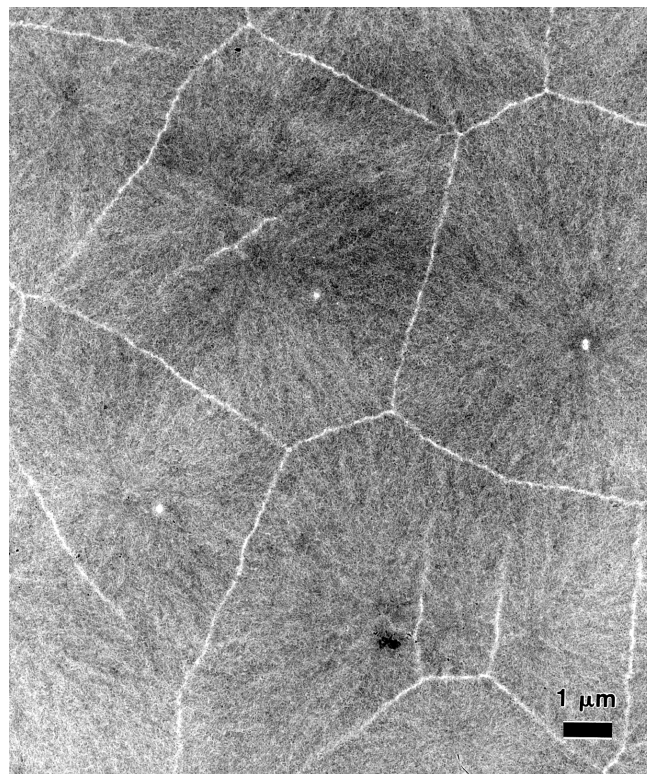

TEM of semi-crystalline *i*-PS thin film (~40 nm) prepared by spin-coating from dilute toluene solution, after annealing at 180 °C for 12 h

**Contributors
and
Collaborators**

W. Wallace, A. Karim (Polymers Division, NIST)

NMR Characterization of Nylon-6/Clay Nanocomposites

David VanderHart, Atsushi Asano

Exfoliated nylon-6/clay nanocomposites having about 5 % clay are quite popular because one achieves improvements in several key properties including barrier properties, fire retardation, modulus, and heat distortion temperature. In this study we a) compare different methods of dispersing the clay in the nylon, b) examine morphological changes arising from the presence of the clay, including the establishment of features which have a bias of proximity to the clay surface, and c) assess the degradation of a certain organic modifier (the compatibilizer between nylon-6 and clay) with processing.

Polymer manufacturers seek to develop new markets using existing, high-volume polymers by tailoring properties through processing modification, e.g., copolymerization, blending with another polymer or filling with solid particles. Nylon-6/clay nanocomposites (NnC's) are an interesting example of filled polymers because the clays that are used are nanoparticles, being plate-like materials about 1 nm thick and about (0.1 to 0.5) nm wide. The two outer surfaces of the clay consist of silicate tetrahedra that, in turn, bound the central layer consisting of octahedral sites, mainly occupied by Al^{+3} with occasional Mg^{+2} and Fe^{+3} substitutions. This ionic character of the clay is used to compatibilize the clay with the polymer via the exchange of the inorganic cation for an organic cation (designated an 'organic modifier'). Tetrasubstituted ammonium ions are often used as organic modifiers. Ideally, the substituents on the ammonium ion should be chemically stable to processing and should promote the mixing of nylon-6 and the clay. From an NMR point of view, the Fe^{+3} sites are also important because they each possess 5 unpaired electrons that make the clay strongly paramagnetic. These unpaired electrons have a substantial impact on the nuclear spins, especially those within the first nm of the clay surface.

There are 2 main methods for preparing these NnC's. One can either polymerize the nylon-6 in the presence of the organically modified clay where, typically, the organic modifier can be covalently incorporated into the polymerizing chains. Or one can simply melt-blend, with vigorous mixing, the organically modified clay with the whole polymer.

We were able to show that, compared to melt crystallized nylon-6, the nylon-6 in these NnC's, with nominal mass fractions 5 % clay, had a very similar crystallinity, very similar crystallite size, yet a dominant γ -crystal form relative to the α -form that is typical of nylon-6. The clay nucleates the γ -form of nylon-6 and at melt-cooling rates of 1 °C/min, greater than 90 % of the crystallites are of the γ -form, regardless of whether one uses *in situ*-polymerized NnC's or melt-blended NnC's.

Processing NnC's usually implies that the viscosity of the

melt is higher than would apply to the pure polymer; hence, there is a tendency to process at temperatures higher than would normally be used for the pure polymer. For an *in situ*-polymerized polymer that was injection molded at 295 °C, we found a reduced ability both to nucleate the γ -phase during melt crystallization and to retain this γ -form upon annealing for several hours at 213 °C. For these injection molded samples, whose melt crystallization history involved relatively rapid cooling, a mixture of the α - and γ -crystal forms were found. However, using the paramagnetic character of the clay as an additional source of relaxation for proton spins, it was ascertained that the average proximity of the γ -crystallites from the clay surfaces was only slightly higher than that of the α -crystallites. This is surprising because the clay preferentially nucleates the γ -phase. However, when these samples are annealed at 213 °C, the fraction of the crystallites in the α -form increases and the morphology is transformed into a highly stratified morphology with the γ crystallites near the clay surfaces and the α crystallites in the more distant, intervening spaces. The proton relaxation induced by the paramagnetism of the clay also provided the justification for claiming that the average proton longitudinal relaxation time, T_1^H , measured at a given magnetic field strength, will provide a relative ranking of the quality of clay dispersion in a set of dry NnC samples that is formulated with the same clay, the same clay/polymer stoichiometry, and the same crystallization history. That claim is supported experimentally; the shorter T_1^H 's correspond to the better clay dispersions.

Finally, in certain cases of the blended NnC's, we could follow the extent of and the chemistry of chemical degradation of the organic modifier (OM). For example, when the nylon and the clay are mixed at 240 °C, the tetraalkylammonium ion, $\text{Me}_2\text{T}_2\text{N}^+$, (Me = methyl and T = hydrogenated tallow $\approx \text{C}_{17}\text{H}_{35}$) degrades to the free amine, MeT_2N , which then phase separates and moves away from the clay surface into the polymer matrix. Interestingly, the amount of degradation is correlated with the combination of higher temperature and mechanical stress, as opposed to temperature alone.

Contributors and Collaborators

J. Gilman (Fire Science Division, NIST)

D.L. Hunter (Southern Clay Products)

Real-Time Monitoring of Biaxial Stretched Film

Anthony Bur

The molecular orientation and the temperature at which they are stretched determine the performance properties of biaxially stretched films. Film processors measure orientation in post processing quality control experiments that are carried out with a considerable time delay after processing. A method for in-line, real-time monitoring of orientation and temperature is needed to avoid costly time delays and rejected product runs. To address this need, we have developed a fluorescence anisotropy sensor for real-time monitoring of fluorescent anisotropy and temperature during biaxial stretching of film.

Polymer film manufacturing consists of biaxially stretching an extruded strip of resin until a film of desired thickness is achieved. The applied extensional stress, if carried out at the appropriate temperature, causes significant molecular orientation. This orientation is the basis for film integrity and its performance properties. Real-time, on-line measurements of anisotropy and temperature are desirable, not only because they avoid post processing characterization, but also because they can be used to monitor film conditions, to detect problems with processing parameters and for process control.

To carry out fluorescence anisotropy measurements a fluorescent dye is incorporated in the polymer by mixing dye and resin at low levels of dye concentration, less than 10^{-5} mass fraction of dye in the resin. A dye with asymmetric geometrical structure is chosen because it will orient under the influence of extensional stress. A molecule that we use for this measurement is bis(di-tert-butylphenyl)-perylene dicarboximide (BTBP).

The anisotropy measurement employs excitation light polarized with a fixed spatial relationship with respect to the principal orientation axis of the film or sheet. Orientation factors are obtained from the emitted fluorescent light, which is analyzed for its polarization. Fluorescence anisotropy, r , is

$$r = \frac{I_{vv} - I_{vh}}{I_{vv} + 2I_{vh}}$$

where I_{vv} and I_{vh} are respectively

vertically and horizontally polarized fluorescent light which are produced by vertically polarized excitation light. For our application v corresponds to the machine direction and h to the transverse direction.

The NIST sensor head contains optics for polarizing the excitation light and analyzing fluorescence polarization. It can be conveniently mounted adjacent to an extruded film or sheet for real-time monitoring, or for acquiring area scans of fluorescence anisotropy. The sensor head has been constructed and interfaced with computer and detection equipment.

The sensor has been installed at a Mobil Chemical Co. production line facility where it is positioned in a tenter oven on a traversing rail that will allow scans of temperature and anisotropy of biaxially stretched polypropylene films.

ANISOTROPY and TEMPERATURE SENSOR

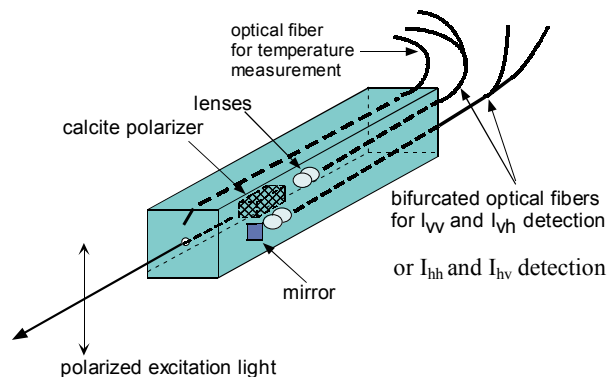

Using this sensor, the specimen can be excited with either vertical or horizontal polarized light, so that biaxial orientations in the machine and transverse directions can be measured. The temperature measurement is obtained from the fluorescence spectrum by measuring the ratio of fluorescence intensities from BTBP at 544 nm and 577 nm.

The area scan shown below is for a biaxially stretched film of polypropylene with a relatively low stretch ratio of 2.5. In production, the stretch ratios reach 7.5. The blue color at 45° corresponds to low anisotropy ($r \approx 0.2$) and the red/orange color is for $r \approx 0.34$. The scanned area is (40 by 50) mm. The standard uncertainty in the measurement is ± 0.005 mm.

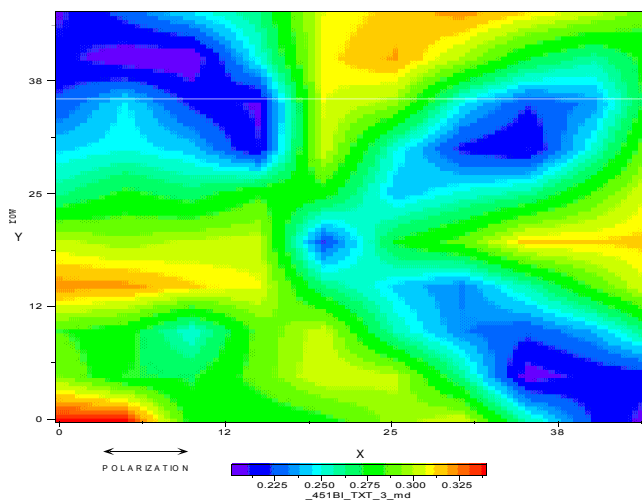

Contributors and Collaborators

A. Bur, S. Roth (Polymers Division, NIST)
M. Amon (Mobil Chemical Co.)

Extrusion Visualization Facility Sheds Light on Processing

Kalman Migler

We have developed optical based technologies for in-line measurements during polymer processing. As described below, applications of the technology include velocimetry and slippage, quality control, and morphological measurements of blends, fibers and dispersions.

Two different flow cells have been used. The first one, called an optical slit die, is shown below. It is located at the exit of a twin-screw extruder. Molten polymer travels through either the horizontal slit or the vertical bypass valve. Two transparent sapphire windows are flush mounted on opposite sides of the slit. (In the figure below, only the top window is visible.) This provides access for the optical instrumentation. A second flow cell is based on flow through a round transparent tube.

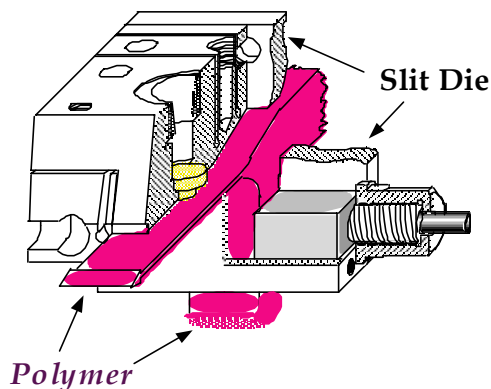

We conduct our studies in both real space through optical microscopy and in reciprocal space through optical light scattering. The optical microscopy is useful for structures larger than approximately 1 μm, whereas the optical light scattering gives indirect information about structures that are as small as 0.1 μm. The optical hardware is configured for rapid switching between these two modes of operation so that nearly simultaneous measurements may be conducted.

The first use that we demonstrate is particle-tracking velocimetry. We track either intentionally imbedded particles, such as 10 μm silica, or the naturally occurring impurities in the material.

The polymer processing industry seeks better methods to evaluate the behavior of resins during manufacture. The NIST extrusion visualization facility allows unprecedented access to monitor the micro-scale morphological development during polymer processing. The flexible optics allow for a variety of applications including flow velocimetry, monitoring of blend structure, quality assurance and additive behavior.

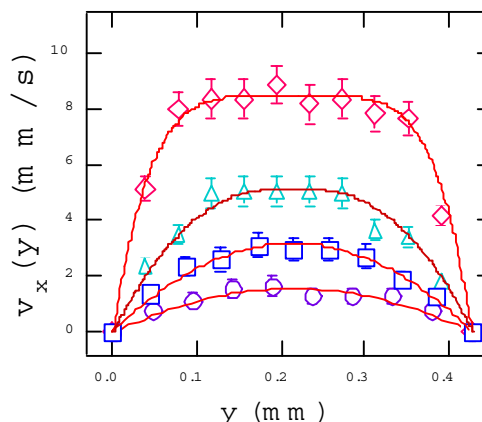

The above figure shows the velocity from one wall to the other. The velocity is zero at both walls and becomes a maximum in the center. As the throughput is increased, we see a transition from parabolic flow at low throughput, to plug like flow at high. Elsewhere in this report we highlighted current work regarding sharkskin and flow profiles.

A second use of the facility is for the determination of structure during processing. The figure below shows the case of a polystyrene/polyethylene (PS/PE) blend as it flows through the slit die. At low shear (left column) the minor component (PS) is nearly spherical as seen by both microscopy (bottom) and light scattering (top). At intermediate throughput, the PS is strongly elongated into string-like structures. At the highest throughput, the morphology reverts to the spherical droplets.

A variety of systems have been studied with the extrusion visualization facility, including liquid crystal polymer blends and reactive systems.

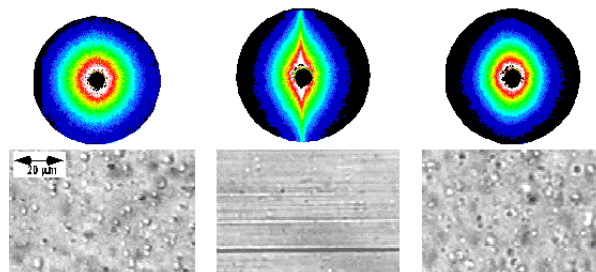

Contributors and Collaborators

K. Migler, K. Flynn, F. Qiao, C. Han, E. Hobbie (Polymers Division, NIST)
 C. Lavallée (3M Canada Company)
 C.L. Gettinger, V.P. Thalacker (3M Company)
 M. Dillon, S.S. Woods (Dyneon LLC)

“Superstring” Structures during Micro-Scale Processing

Kalman Migler

Polymer blends are traditionally used in macroscopic applications where the synergetic properties of two immiscible polymers can be exploited, such as in nylon / rubber blends. The length scale of the dispersed phase is typically of order 0.3 μm whereas the length scale of the part manufactured from the blend is much larger (e.g., a car bumper). There is current interest in micro and nano length scale technologies in which polymer blends could play an important role, but the physics of processing polymeric emulsions when the droplet size is comparable to a sample dimension is poorly understood. Here we report on several novel phenomena that occur in this regime.

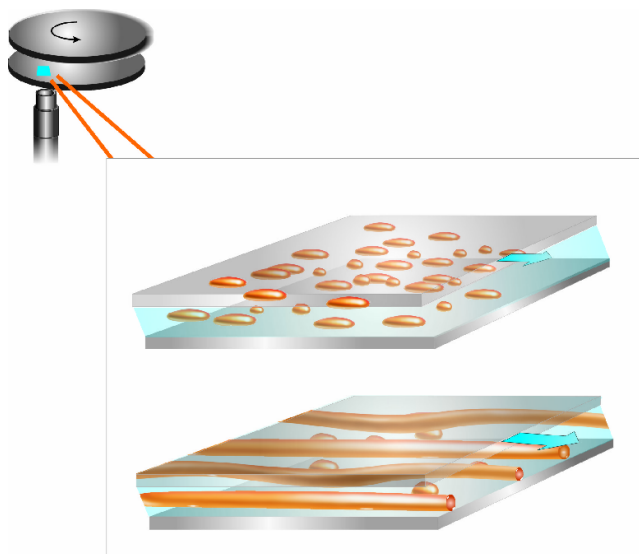

The size and morphology of the dispersed component is determined during material processing and is crucial to the final physical properties; for example, fibers can provide great enhancements in unidirectional strength, sheet structures can possess ultra-low permeability and spherical inclusions provide impact resistance.

Here, we shear a polymer blend between two transparent plates and examine the structures as a function of the width of the gap between the shearing plates. It is well known that there is a maximum stable size for droplets of one component

Manufacturers of medical and optical devices are under increasing pressure to miniaturize their components. However, the concepts and practices that are commonly used in macro-scale fabrication may need to be significantly altered when working at smaller length scales. Here we explore the breakdown of fundamental principles of polymer blends mixing that occur when the part size scale becomes small.

dispersed in a matrix of a second component. We have discovered a transition between droplets at high shear and strings at low shear that occurs when the size of the dispersed droplets becomes comparable to the gap width between the shearing surfaces (illustration on lower left). The transition is abrupt and proceeds via the coalescence of droplets in a four stage kinetic process (below). Once formed, the strings are stable and exhibit pronounced hysteresis.

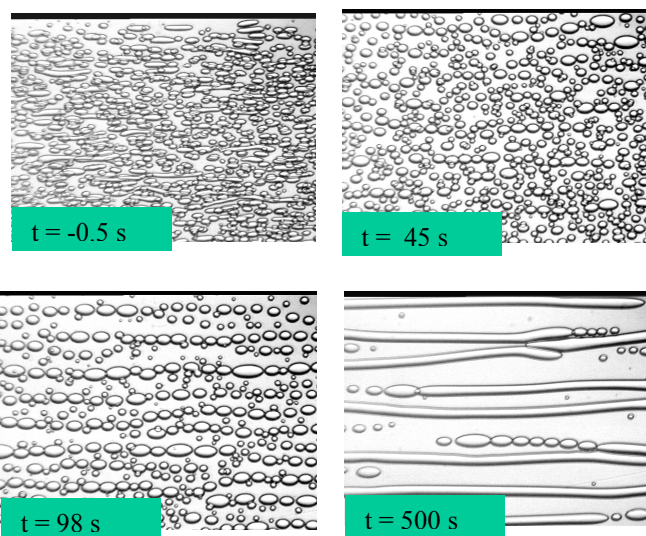

These experiments were conducted on custom built precision instrumentation that was developed in the Polymers Division for the study of polymer blends under shear. The apparatus allows for nearly simultaneous optical microscopy and light scattering to visualize blend structure over a wide range of length scales.

There are intriguing possible applications of this technology. If the string component was conductive and the matrix was an insulator with good mechanical properties, then one could produce wires. If the processing was done at elevated temperature and the string component formed into a fiber, one could have ultra-thin materials of high one-dimensional strength. A third application would be to dissolve out the string component and use the resulting structures as scaffolds in tissue engineered products.

Contributors and Collaborators

K. Migler, C. Han (Polymers Division, NIST)

Interfaces in Fiber Reinforced Polymer Composites

Joseph Lenhart, Richard Parnas

A dimethylaminonitrostilbene fluorophore was tethered to a triethoxy silane coupling agent, generating a fluorescently labeled silane coupling agent (FLSCA).

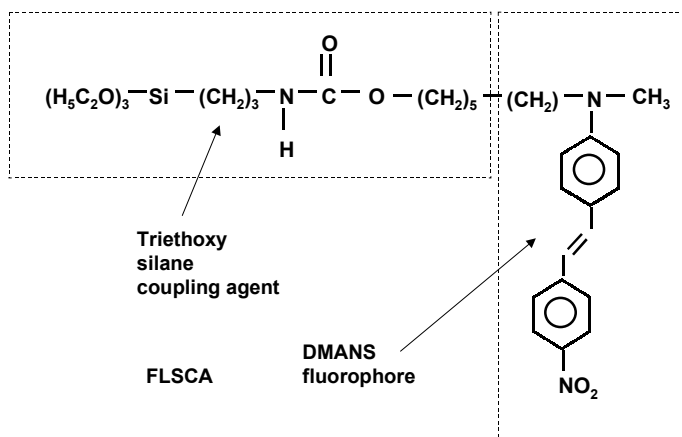

Glass surfaces were coated with silane coupling agent multi-layers that were doped with small levels of the FLSCA molecule. The silane-coated glass was then immersed in epoxy resin and the resin cured. A blue shift in FLSCA emission and an increase in the emission intensity could be followed during resin cure, illustrating the probe sensitivity to interfacial cure. The emission maximum from FLSCA grafted to the glass surface was different than when FLSCA was dissolved into bulk epoxy resin, suggesting a different interfacial structure.

When the dye was dissolved into bulk cured resin, a distinct break in the fluorescence maximum versus temperature slope was detected at the glass transition of the bulk epoxy. Similar breaks were observed from the grafted FLSCA layers, illustrating sensitivity of the localized probe to the buried interfacial glass transition. The temperature of the interfacial transition was dependent on the initial structure of the grafted silane coupling agent layer. Physically adsorbed material from the unwashed silane coupling agent layers generated a zone of plasticized polymer in the buried interface, leading to a lower interfacial transition temperature.

Manufacturers of fiber-reinforced composites seek to improve properties by manipulating the interface between reinforcement and matrix. However, there are no suitable methods to probe the chemical and physical characteristics owing to the small size and inaccessibility of the buried interface. We developed a technique to probe the structure of buried interfacial regions relevant to glass fiber reinforced composites by localizing a viscosity sensitive fluorescent dye on the substrate surface. Through use of optical fiber methods interface measurements may be made on buried interfaces.

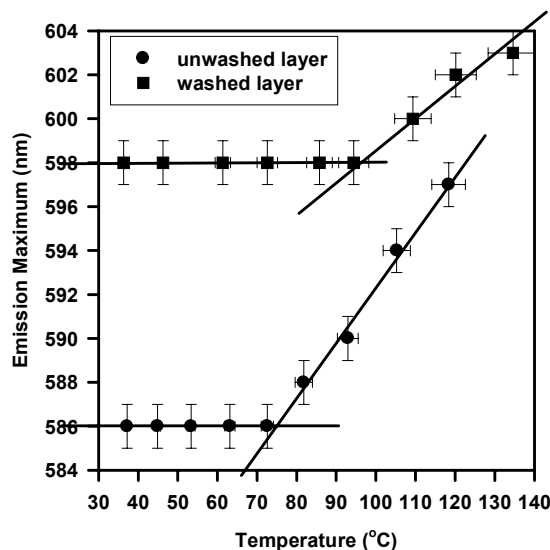

Washed layers were tightly bound to the glass surface, restricting the polymer motion in the interfacial region and raising the interfacial transition temperature. For the figure above, the glass transition of the bulk resin was $(85 \pm 3) ^\circ\text{C}$.

This was the first measurement of a glass transition temperature in sub-micrometer buried polymer / substrate interfacial regions. The work was recently published in *J. Coll. Interface Sci.* **221**, 75, **2000** and *Langmuir* **16**, 8145, **2000** and another article was submitted to *Macromolecules*. A proceedings paper for the Society of Plastics Engineers Annual Conference in Orlando FL (May 2000) won the best paper award in the Thermoset Division.

The technique can be made practical for monitoring resin cure and interfacial development during composite manufacturing by grafting the FLSCA layers to a glass fiber optic. The fiber optic can be inserted into the composite mold and measurements made *in-situ* during processing.

**Contributors
and
Collaborators**

J. Lenhart, J. Dunkers, R. Parnas (Polymers Division, NIST)
J. van Zanten (North Carolina State University)

Fiber Optic Flow and Cure Sensing for Liquid Composite Molding

Joy Dunkers, Joseph Lenhart

Major advantages of polymer matrix composites include a high strength-to-weight ratio, corrosion resistance, and thermal and electrical insulating properties. However, the cost of polymer matrix composites must be reduced to be competitive in consumer markets. One strategy is to decrease manufacturing cost through process optimization and reduction of scrap. The introduction of fiber optic sensors into the liquid composite molding (LCM) process for flow and cure monitoring provides a non-invasive means of obtaining real time information on mold filling and resin cure for control decisions.

Under typical composite manufacturing circumstances, it is difficult to detect if the resin is saturating the preform. Embedded sensors can help monitor the impregnation process. For the first time, long period gratings (LPGs) will be used as embedded flow monitoring sensors in LCM to detect the arrival of resin in the mold during filling. LPGs are similar to Bragg gratings, but function differently because they are used to couple light out of the core. LPGs have a grating periodicity of typically (130 to 150) μm . When the higher index resin covers a LPG sensor, the light that would have been attenuated gets coupled back into the core and, hence, the dip in the transmission spectrum disappears. Resin flow-front information is very useful to composite manufacturers because it alerts them to specific problems that occur during resin injection.

The figure below shows a typical spectrum of an optical fiber with two LPGs written on it. The vertical axis is relative intensity with respect to the maximum intensity detected by the system for that particular scan. In this case, the LPGs were written such that light at 1509 nm and 1549 nm would be filtered out, as evident from the transmission dips seen in that figure. These dips disappear when the resin covers one sensor, coupling the light at 1509 nm back into the core-propagating mode. When both LPGs are covered, the spectrum is like that of an optical fiber without any LPGs written on it. Since each of the LPGs is written at distinctly different wavelengths, it is possible to identify where and when the sensors are covered.

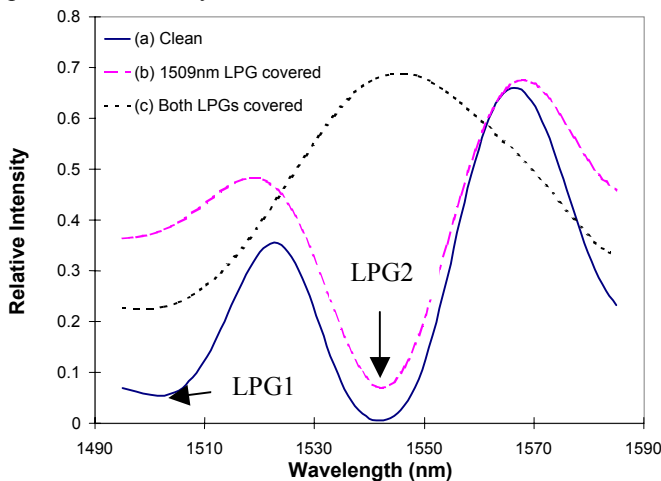

Fluorescence has been used to monitor resin cure when the dye is dissolved in the bulk resin. This can create problems in a manufacturing environment. First, an extra processing step may be required to mix the dye into the resin. Second, the dye can drastically change the resin color. Finally, the fluorescence response comes from the bulk polymer and the behavior of the fiber / resin interface is ignored. Even if evanescent wave techniques are used, the evanescent wave can still propagate a micrometer or more into the resin, and much of the sensor response will be from the bulk resin.

A fluorescent probe molecule has been tethered to a triethoxy silane-coupling agent, generating a fluorescently labeled silane coupling agent molecule (FLSCA). To obtain an interfacial sensitive response, silane coupling agent chemistry is then used to graft FLSCA to a high refractive index glass fiber optic.

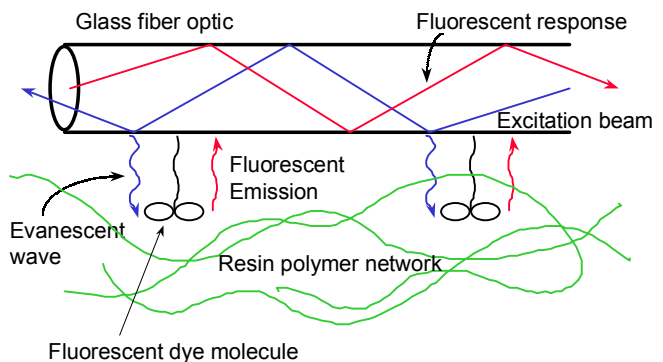

When the fiber optic is immersed in epoxy resin, an increase in fluorescence intensity and a blue shift in the fluorescence emission can be monitored during resin cure.

The fiber optic LPGs sensor was successfully demonstrated in an industrial vacuum assisted resin transfer molding operation at WebCore in Dayton, OH.

Contributors and Collaborators

J. Lenhart, J. Dunkers R. Parnas (Polymers Division, NIST)
 S. Kueh, S. Advani (University of Delaware)
 J. van Zanten (North Carolina State University)
 P. Furrow, M. Jones (F&S/Luna Innovations)

Polymers Division Publications

- Alamo, R. G.; Isasi, J. R.; Kim, M. H.; Mandelkern, L., and Vanderhart, D. L., "Thermal and Structural Behavior of Metallocene-Type Random Propylene Copolymers", Abstracts of Papers of the American Chemical Society 1999 Aug 22; 218:244-PMSE.
- Alamo, R. G.; Vanderhart, D. L.; Nyden, M. R., and Mandelkern, L., "Morphological Partitioning of Ethylene Defects in Random Propylene-Ethylene Copolymers", *Macromolecules* 2000 Aug 8; 33(16):6094-6105.
- Allegrini, P.; Douglas, J. F., and Glotzer, S. C., "Dynamic Entropy as a Measure of Caging and Persistent Particle Motion in Supercooled Liquids", *Physical Review E* 1999 Nov; 60(5):5714-5724.
- Amis, E. J.; Bauer, B. J.; Topp, A.; Groehn, F.; Prosa, T. J.; Viers, B. D.; Liu, D. W.; Barnes, K. A.; Jackson, C. L.; Nisato, G.; Karim, A., and Douglas, J. F., "Preparation and Characterization of Polymer/Dendrimer Blends - Final Report, March 2000", NISTIR 6506; 2000.
- Amis, E. J. and Fanconi, B. M., "Polymers Division Technical Activities - 1999", NISTIR 6435; 1999.
- Antonucci, J. M.; Skrtic, D., and Eanes, E. D., "Polymer Matrix Effects on the Properties of Amorphous Calcium Phosphate-filled Composites", *Polymer Preprint (ACS Natl. Mtg., Washington, DC, August 2000)* 2000.
- Antonucci, J. M.; Stansbury, J. W., and Fowler, B. O., "Ethyl α -Hydroxymethylacrylate, A Novel Isomeric Analog of 2-Hydroxyethyl Methacrylate (HEMA)", *Transactions of 6th World Biomaterials Congress; Kameuela, HA.*
- , "An Improved Synthesis of Ethyl α -Hydroxymethylacrylate, a Unique Isomeric Analog of HEMA.", *Proc. of the ACS Natl. Mtg., Wash., DC, August 2000* 2000.
- , "Synthesis and Characterization of Ethyl α -Hydroxymethylacrylate, a Novel Isomeric Analog of HEMA.", *Journal of Dental Research* 2000; 79:30.
- Atalla, R. H. and Vanderhart, D. L., "The Role of Solid State C-13 NMR Spectroscopy in Studies of the Nature of Native Celluloses", *Solid State Nuclear Magnetic Resonance* 1999 Oct; 15(1):1-19.
- Barnes, J. D.; Fanconi, B. M., and Amis, E. J., "POLYMER99 - NIST Polymers Division Published Works for 1999", NISTIR/CD2000.
- Barnes, J. D.; Kolb, R.; Barnes, K. A.; Nakatani, A. I., and Hammouda, B., "Microstructure Analysis Using Temperature-Induced Contrast Variation in Small-Angle Scattering", Abstracts of Papers of the American Chemical Society 1999 Aug 22; 218:265-PMSE.
- Barnes, K. A.; Douglas, J. F.; Liu, D. W.; Bauer, B.; Amis, E. J., and Karim, A., "Influence of Generation Number on the Dewetting of Hypergraft Poly(2-Ethyl-2-Oxazoline) Films", *Polymer International* 2000 May; 49(5):463-468.
- Barnes, K. A.; Karim, A.; Douglas, J. F.; Nakatani, A. I.; Gruell, H., and Amis, E. J., "Suppression of Dewetting in Nanoparticle-Filled Polymer Films", *Macromolecules* 2000 May 30; 33(11):4177-4185.
- Bauer, B. J. and Amis, E. J., "Characterization of Dendritically Branched Polymers by SANS, SAXS, and TEM", in *Dendritic Polymers*, ed.: Tomalia, D. A. and Frechet, J. M. J.; in press.
- Bauer, B. J.; Ramzi, A.; Liu, D. W.; Scherrenberg, R. L.; Froehling, P., and Joosten, J., "Blends of Fatty-Acid-Modified Dendrimers With Polyolefins", *Journal of Polymer Science Part B-Polymer Physics* 2000 Jan 1; 38(1):95-100.
- Blair, W. R.; Guttman, C. M., and Guiseppetti, A. A., "Surface Morphology Variations in MALDI-TOF-Mass Spectrometry Samples Prepared by Various Techniques Examined by Scanning Electron Microscopy", *Proc. of the 48th ASMS Conf. on Mass Spectrometry and Allied Topics.* 2000.

- Bloss, P.; Dereggi, A. S.; Glasel, H. J.; Hartmann, E.; Hirsch, D., and Schafer, H., "Polarization Distribution in Ceramic-Polymer Nanocomposites", *Journal of Applied Physics* 1999 Sep 1; 86(5):2712-2718.
- Bloss, P.; DeReggi, A. S., and Schafer, H., "Electric Field Profile and Thermal Properties in Substrate-Supported Dielectric Films", *Phys. Rev. B* 2000 Sep 15; 62(12):8517-8530.
- Bloss, P.; Dereggi, A. S.; Yang, G. M.; Sessler, G. M., and Schafer, H., "Thermal and Acoustic Pulse Studies of Space-Charge Profiles in Electron-Irradiated Fluoroethylene Propylene", *Journal of Physics D-Applied Physics* 2000 Feb 21; 33(4):430-436.
- Bowen, R. L.; Farahani, M.; Dickens, S. H., and Guttman, C. M., "MALDI ToF MS Analysis of a Library of Polymerizable Cyclodextrin Derivatives", *Journal of Dental Research* 2000 Apr; 79(4):905-911.
- Briggman, K. A.; Richter, L. J.; Stephenson, J. C., and Wallace, W. E., "Structure of Thin Polymer Film Interfaces Using Broadband Vibrationally Resonant Sum-Frequency Generation", *Abstracts of Papers of the American Chemical Society* 2000 Mar 26; 219:362.
- Bu, Z. M.; Neumann, D. A.; Lee, S. H.; Brown, C. M.; Engelman, D. M., and Han, C. C., "A View of Dynamics Changes in the Molten Globule-Native Folding Step by Quasielastic Neutron Scattering", *Journal of Molecular Biology* 2000 Aug 11; 301(2):525-536.
- Bur, A. J. and Roth, S. C., "Fluorescence Based Temperature Measurements and Applications to Real-Time Polymer Processing", *Proc. of the Society of Plastics Engineers Annual Technical Meeting; Orlando, FL*.
- Bur, A. J.; Roth, S. C., and Thomas, C. L., "Fluorescence Anisotropy Sensor and Its Application to Polymer Processing and Characterization", *Review of Scientific Instruments* 2000 Mar; 71(3):1516-1523.
- Bur, A. J. and Thomas, C. L., "An Optical Sensor for Polymer Injection Molding", *Proc. of the 197th Electrochemical Society Meeting; Toronto, Canada*.
- Cerrada, M. L. and Mckenna, G. B., "Physical Aging of Amorphous PEN: Isothermal, Isochronal and Isostructural Results", *Macromolecules* 2000 Apr 18; 33(8):3065-3076.
- Chiang, C. K.; Popielarz, R.; Nozaki, R., and Obrzut, J., "Broadband Dielectric Relaxation of Polymer Composite Films", *Organic/Inorganic Hybrid Materials 2000; San Francisco, CA*.
- Chiang, C. K.; Wallace, W. E.; Lynn, G. W.; Feiler, D., and Xia, W., "Thermally Induced Stress Relaxation and Densification of Spin-on-Glass Thin Films", *Applied Physics Letters* 2000 Jan 24; 76(4):430-432.
- Chiang, M. Y. and Fernandez-Garcia, M., "Effect of Hygrothermal Aging History on Swelling and T_g in a Commercial Adhesive", *Proc. of the 23rd Annual Meeting of The Adhesion Society*.
- Chiang, M. Y. M.; Fernandez-Garcia, M., and Yorkgitis, E. M., "Effect of Water Exposure Cycles on Physical Properties of a Particle-Filled, Epoxy-Based Adhesive", *Proc. of SAMPE 2000 Meeting*.
- Choi, S.; Briber, R. M.; Bauer, B. J.; Liu, D. W., and Gauthier, M., "Small-Angle Neutron Scattering of Blends of Arborescent Polystyrenes", *Macromolecules* 2000 Aug 22; 33(17):6495-6501.
- Choi, S.; Briber, R. M.; Bauer, B. J.; Topp, A.; Gauthier, M., and Tichagwa, L., "Small-Angle Neutron Scattering of Solutions of Arborescent Graft Polystyrenes", *Macromolecules* 1999 Nov 16; 32(23):7879-7886.
- Chou, K. F.; Han, C. C., and Lee, S., "Water Transport in 2-Hydroxyethyl Methacrylate Copolymer Irradiated by Gamma Rays in Air and Related Phenomena", *Journal of Polymer Science Part B-Polymer Physics* 2000 Mar 1; 38(5):659-671.
- , "Water Transport in Crosslinked 2-Hydroxyethyl Methacrylate", *Polymer Engineering and Science* 2000 Apr; 40(4):1004-1014.
- Dereggi, A. S.; Balizer, E.; Neumann, D. A., and Bateman, F., "Electrostriction Mechanism in Electron-Irradiated Ferroelectric Copolymer: A Frequency Response Model", *Conference on Electrical Insulation and Dielectric Phenomena*.
- Donati, C.; Glotzer, S. C.; Poole, P. H.; Kob, W., and Plimpton, S. J., "Spatial Correlations of Mobility and Immobility in a Glass-Forming Lennard-Jones Liquid", *Physical Review E* 1999 Sep; 60(3):3107-3119.

- Douglas, J. F.; Kent, M. S.; Satija, S. K., and Karim, A., "Swelling of Grafted Polymer "Brushes"", Encyclopedia of Materials: Science and Technology in press.
- Dudowicz, J.; Freed, K. F., and Douglas, J. F., "Lattice Model of Living Polymerization. I. Basic Thermodynamic Properties", Journal of Chemical Physics 1999 Oct 15; 111(15):7116-7130.
- , "Lattice Model of Living Polymerization. II. Interplay Between Polymerization and Phase Stability", Journal of Chemical Physics 2000 Jan 8; 112(2):1002-1010.
- , "Lattice Model of Living Polymerization. III. Evidence for Particle Clustering From Phase Separation Properties and "Rounding" of the Dynamical Clustering Transition", Journal of Chemical Physics 2000 Jul 1; 113(1):434-446.
- Dunkers, J. P.; Everett, M. J.; Sanders, D. P., and Hunston, D. L., "Imaging of Composite Defects and Damage Using Optical Coherence Tomography", Proc. of PLAST, Advancing with Composites 2000; Milan, Italy.
- Dunkers, J. P.; Labazzo, K. S.; Kohn, J, and Parnas, R. S., "Optical Coherence Tomography for Imaging Tissue Scaffolds", NISTIR 6535 2000; 25-30.
- Dunkers, J. P.; Lenhart, J. L.; Kueh, S. R.; van Zanten, J. H.; Advani, S. G., and Parnas, R. S., "Fiber Optics Flow and Cure Sensing for Liquid Composite Molding", Proc. of the Intl. Conf. on Trends in Optical Nondestructive Testing ; Lugano, Switzerland.
- Dunkers, J. P.; Phelan, F. R.; Sanders, D. S.; Everett, M. J.; Green, W. H.; Hunston, D. L., and Parnas, R. S., "The Application of Optical Coherence Tomography in Problems in Polymer Matrix Composites", Journal of Optics and Lasers in Engineering in press.
- Dunkers, J. P.; Sanders, D. S.; Hunston, D. L., and Everett, M. J., "Imaging of Impact Damage in Composites Using Optical Coherence Tomography", Proc. of the 23rd Annual Meeting of The Adhesion Society; Blacksburg, VA.
- Evmenenko, G.; Bauer, B. J.; Kleppinger, R.; Forier, B.; Dehaven, W.; Amis, E. J.; Miscehnko, N., and Reynaers, H., "The Influence of Molecular Architecture and Solvent Type on the Size of Structure of Poly(benzyl ether) Dendrimers by SANS", Physica B 2000 Mar; 276:349-350.
- Ferreiro, V.; Douglas, J. F.; Coulon, G., and Karim, A., "Atomic Force Microscopy Studies of Phase Ordering in Polymer Blends and Clay-Filled Systems", ACS Polymer Preprint 2000.
- Fitzpatrick, K. T.; Antonucci, J. M., and Schumacher, G. E., "Effect of Photoinitiator Concentration in a Dentin Bonding System", Journal of Dental Research 2000; 79:849.
- Franz, S.; Donati, C.; Parisi, G., and Glotzer, S. C., "On Dynamical Correlations in Supercooled Liquids", Philosophical Magazine B-Physics of Condensed Matter Statistical Mechanics Electronic Optical and Magnetic Properties 1999; 79(11-12):1827-1831.
- Friedman, H. L.; Johnson, R. A.; Gusev, V.; Neimark, A. V.; Buvel, D.; Salem, D. R., and Parnas, R. S., "Visualization and Quantification of Forced in-Plane Flow Through Deformed Porous Media", Polymer Composites 1999 Oct; 20(5):613-627.
- Gilman, J. W.; Harris, R. H.; Jackson, C. L.; Morgan, A. B.; Brassell, L. D., and Hunter, D. L., "Phenolic Cyanate Ester Clay Nanocomposites: Effect of Ammonium Ion Structure on Flammability and Nanodispersion", ACS PMSE Preprints 2000 Mar 26; 82:276.
- Gilman, J. W.; Jackson, C. L.; Morgan, A. B.; Harris, R.; Manias, E.; Giannelis, E. P.; Wuthenow, M.; Hilton, D., and Phillips, S. H., "Flammability Properties of Polymer - Layered-Silicate Nanocomposites. Polypropylene and Polystyrene Nanocomposites", Chemistry of Materials 2000 Jul; 12(7):1866-1873.
- Gilman, J. W.; Kashiwagi, T.; Morgan, A. B.; Harris, R. H.; Brassell, L.; VanLandingham, M., and Jackson, C. L., "Flammability of Polymer Clay Nanocomposites Consortium: Year One Annual Report", NISTIR 6531; 2000 Jul.
- Glotzer, S. C., "Spatially Heterogeneous Dynamics in Liquids: Insights From Simulation", Journal of Non-Crystalline Solids 2000 Sep; 274(1-3):342-355.
- Glotzer, S. C.; Jans, N., and Poole, P. H., "The Potential Energy Landscape of the +/- J Ising Spin Glass", Journal of Physics-Condensed Matter 2000 Jul 24; 12(29):6675-6682.

- Glotzer, S. C.; Novikov, V. N., and Schroder, T. B., "Time-Dependent, Four-Point Density Correlation Function Description of Dynamical Heterogeneity and Decoupling in Supercooled Liquids", *Journal of Chemical Physics* 2000 Jan 8; 112(2):509-512.
- Glotzer, S. C. and Starr, F. W., "Multiscale Modeling of Filled and Nonfilled Polymers", *Proc. of Foundations of Molecular Modeling and Simulation* 2000.
- Goldschmidt, R. J. and Guttman, C. M., "Matrix Clusters and Polymer-Matrix Adducts in the MALDI Analysis of Polystyrene", *Proc. of the 48th ASMS Conf. on Mass Spectrometry and Allied Topics.*; Long Beach, CA.
- , "Response Saturation of Polystyrene in MALDI", *Abstracts of Papers of the American Chemical Society* 2000 Mar 26; 219:53-POLY.
- Goldschmidt, R. J.; Wetzel, S. J.; Blair, W. R., and Guttman, C. M., "Post-Source Decay in the Analysis of Polystyrene by Matrix-Assisted Laser Desorption/Ionization Time-of-Flight Mass Spectrometry", *J. of the American Society for Mass Spectrometry* 2000; 11:1095-1106.
- Groehn, F.; Akpalu, Y. A.; Bauer, B. J., and Amis, E. J., "Organic-inorganic Hybrid Structures with Dendrimers: A Small Angle X-ray Scattering Study on a Mesoscopic Model System", 1999 National Synchrotron Light Source Activity Report 2000.
- Groehn, F.; Bauer, B. J.; Akpalu, Y. A.; Jackson, C. L., and Amis, E. J., "Dendrimers as Templates for the Formation of Inorganic Nanoclusters", *Macromolecules* in press.
- Groehn, F.; Bauer, B. J., and Amis, E. J., "Organic-Inorganic Hybrid Particles by Dendrimer Nanotemplating", *Proc. of the Materials Research Society Mtg*; San Francisco.
- Gröhn, F.; Bauer, B. J.; Akpalu, Y. A.; Jackson, C. L., and Amis, E. J., "Dendrimer Templates for the Formation of Gold Nanoclusters", *Macromolecules* 2000 Aug 8; 33(16):6042-6050.
- Grohn, F.; Bauer, B. J., and Amis, E. J., "Templating Nanocrystals With Dendrimers: a Mesoscopic Model System", *Abstracts of Papers of the American Chemical Society* 2000 Mar 26; 219:295-POLY.
- Guttman, C. M.; Maurey, J. R., and Blair, W. R., " Certification of the Relative Molecular Mass and the Limiting Viscosity of SRM 2886, a Polyethylene of Narrow Molecular Mass Distribution", *NISTIR* 6487; 2000.
- Guttman, C. M.; Maurey, J. R.; Blair, W. R., and Schultheisz, C. R., " Certification of the Relative Molecular Mass and the Limiting Viscosity of SRM 2887, a Polyethylene of Narrow Molecular Mass Distribution ", *NISTIR* 6456; 2000.
- Guttman, C. M.; Maurey, J. R., and Blair, W. R. Schultheisz, C. R., " Certification of the Relative Molecular Mass and the Limiting Viscosity of SRM 2885, a Polyethylene of Narrow Molecular Mass Distribution ", *NISTIR* 6454; 2000.
- Guttman, C. M.; Wetzel, S. J.; Blair, W. R.; Fanconi, B. M.; Girard, J. E.; Goldschmidt, R. J.; Wallace, W. E., and VanderHart, D. L., "National Institute of Standards and Technology Sponsored Interlaboratory Comparison of Polystyrene Molecular Mass Distribution Obtained by Matrix Assisted Laser Desorption Ionization Time-of-Flight Mass Spectrometry: Statistical Analysis", *Analytical Chemistry* in press.
- Guttman, C. M.; Wetzel, S. J.; Wallace, W. E.; Blair, W. R.; Goldschmidt, R. M.; Vanderhart, D., and Fanconi, B. M., "Determination of the Molecular-Mass Distribution of a Narrow Polydispersity Polystyrene by MALDI ToF MS: Interlaboratory Comparison", *Abstracts of Papers of the American Chemical Society* 2000 Mar 26; 219:281-POLY.
- Han, C. C., "Kinetics of Polymer Phase Separation", *Encyclopedia of Materials: Science and Technology* 2000.
- Harris, G. R.; Preston, R. C., and DeReggi, A. S., "The Impact of Piezoelectric PVDF on Medical Ultrasound Exposure Measurements, Standards and Regulations", *IEEE Transactions on Ultrasonics, Ferroelectrics and Frequency Control* 2000; 47(6):1321-1335.
- Hobbie, E. K., "Depletion-Driven Phase Separation and Reversible Aggregation in Confined Colloidal Mixtures", *Langmuir* 1999 Dec 21; 15(26):8807-8812.
- Hobbie, E. K. and De Reggi, A. S., "Laser-Pulse Technique for Measuring the Thermal Diffusivity of Substrate-Supported Polymer Films", *Review of Scientific Instruments* 1999 Nov; 70(11):4356-4358.

- Hobbie, E. K. and Stewart, A. D., "Internal Dynamics and Elasticity of Confined Entropic Gels", *Physical Review E* 2000 May; 61(5):5540-5544.
- Holmes, G. A.; Feresenbet, E.; Pohl, E.; McDonough, W. G.; Raghavan, D., and Thompson, D., "Factors that Affect Adhesion at the Fiber-Matrix Interface in Composites", *Proc. of the 23rd Annual Meeting of The Adhesion Society*; Blacksburg, VA.
- Holmes, G. A.; Hunston, D. L.; McDonough, W. G., and Peterson, R. C., "A New Methodology for Determining Interfacial Shear Strength in Single Fiber Composites", *Advanced Composite Technology for 21st Century Transportation* .
- , "Single Fiber Composites: A New Methodology for Determining Interfacial Shear Strength", *Proc. of the 2000 Annual Technical Conf. of the Society of Plastics Engineers*.
- , "A Test Method for Assessing Interfacial Shear Strength in Composites", *Proc. of SAMPE 2000 Meeting*.
- Holmes, G. A.; Petersen, R. C.; Hunston, D. L.; McDonough, W. G., and Schutte, C. L., " The Effect of Non-Linear Viscoelasticity on Interfacial Shear Strength Measurements", in *Time Dependent and Nonlinear Effects in Polymers and Composites*, ed.: West Conshohocken: ASTM; 2000; pp. 98-117 .
- Holmes, G. A.; Peterson, R. C.; Hunston, D. L., and McDonough, W. G., "E-Glass/Dgeba/M-Pda Single Fiber Composites: the Effect of Strain Rate on Interfacial Shear Strength Measurements", *Polymer Composites* 2000 Jun; 21(3):450-465.
- Hunston, D.; Holmes, G., and Peterson, R., "Viscoelastic Properties of a Resin Commonly Used in the Single Fiber Fragmentation Test", *Journal of Reinforced Plastics and Composites* 1999; 18(18):1346-1657.
- Hunston, D. L.; He, J.; Raghavan, R., and Hoffman, D., "Load History Dependence of Fracture in Rubber-Toughened Epoxies", *Proc. of the 23rd Annual Meeting of The Adhesion Society Meeting*; Blacksburg, VA.
- Hunston, D. L.; Holmes, G. A.; Peterson, R. C., and McDonough, W. G., "Strain Rate Effects in the Single Fiber Fragmentation Test for Fiber-Matrix Adhesion", *Abstracts of Papers of the American Chemical Society* 1999 Aug 22; 218:251-PMSE.
- Jeon, H. S. and Nakatani, A. I., "Shear-Induced Novel Structure in Phase-Separated Polybutadiene/Polyisoprene Blends", *Abstracts of Papers of the American Chemical Society* 2000 Mar 26; 219:159-PMSE.
- Jeon, H. S.; Nakatani, A. I.; Han, C. C., and Colby, R. H., "Effects of Domain Interfaces on the Rheological Properties of Polybutadiene/Polyisoprene Blends", *Abstracts of Papers of the American Chemical Society* 2000 Mar 26; 219:6-PMSE.
- Jeon, H. S.; Nakatani, A. I.; Hobbie, E. K., and Han, C. C., "Phase Inversion of Polybutadiene/Polyisoprene Blends Under Quiescent and Shear Conditions", *Langmuir* 2000.
- Karim, A. and Douglas, J. F., "Polymer-Surface Interactions in Nanofilled Polymers", *Abstracts of Papers of the American Chemical Society* 2000 Mar 26; 219:73-PMSE.
- Karim, A.; Douglas, J. F.; Nisato, G.; Liu, D. W., and Amis, E. J., "Transient Target Patterns in Phase Separating Filled Polymer Blends", *Macromolecules* 1999 Sep 7; 32(18):5917-5924.
- Karim, A.; Liu, D. W.; Douglas, J. F.; Nakatani, A. I., and Amis, E. J., "Modification of the Phase Stability of Polymer Blends by Fillers", *Polymer* 2000 Nov; 41(23):8455-8458.
- Karim, A.; Sehgal, A., and Amis, E. J., "AFM Studies of Confined Dewetting on Gradient Patterned Surfaces", *Abstract for 2000 ACS Meeting*; Washington, DC.
- Kelly, J. R.; Berninghaus, M. E., and Antonucci, J. M., "Failure Behavior and Modeling of All-Ceramic Fpd Connectors", *Journal of Dental Research* 2000; 79:165.
- Khatri, C. A.; Antonucci, J. M., and Stansbury, J. W., "Synthesis and Characterization of Urethane Derivatives of Bis- GMA", *Journal of Dental Research* 2000; 79:29.

- Khatri, C. A.; Antonucci, J. M.; Stansbury, J. W., and Schultheisz, C. R., "Synthesis, Characterization and Evaluation of Urethane Derivatives of Bis-GMA", Polymer Preprints ACS National Meeting, Washington, D.C. 2000.
- Kielhorn, L.; Colby, R. H., and Han, C. C., "Relaxation Behavior of Polymer Blends After the Cessation of Shear", *Macromolecules* 2000 Apr 4; 33(7):2486-2496.
- Kim, G.; Jackson, C. L.; Prosa, T. J.; Liu, D.-W., and Bauer, B. J., "Nanocomposites of Molecularly Dispersed Polyamidoamine (PAMAM) Dendrimers", *ACS-PMSE Preprints* 2000; 82:296.
- Kim, S. D.; Klein, A.; Sperling, L. H.; Boczar, E. M., and Bauer, B. J., "SANS Study of Sulfite End Group Effect on Polystyrene Self-Diffusion", *Macromolecules* 2000 Oct 31; 33(22):8334-8343.
- Kofinas, P.; Drzal, P. L., and Barnes, J. D., "Path Dependent Microstructure Orientation During Plane Strain Compression of Semicrystalline Block Copolymers", *Polymer* in press.
- Kolb, R.; Nakatani, A. I.; Barnes, K. A.; Barnes, J. D., and Hammouda, B., "Microstructure Analysis Using Temperature Induced Contrast Variation in Small-Angle Scattering", *Journal of Applied Crystallography* 2000; 33:758-762.
- Kueh, S.; Parnas, R. S.; Dunkers, J. P.; Advanti, S. G.; Furrows, P. S.; Jones, M. E., and Bailey, T. A., "Long Period Gratings as Flow Sensors for Liquid Composite Molding", *Proc. of the SPIE's 5th Intl. Symposium on Nondestructive and Health Monitoring of Aging Infrastructure*.
- Kueh, S. R. M.; Advani, S. G., and Parnas, R. S., "Sensor Placement Study for Online Flow Monitoring in Liquid Composite Molding", *Polymer Composites* 2000 Jun; 21(3):436-449.
- La Nave, E.; Scala, A.; Starr, F. W.; Sciortino, F., and Stanley, H. E., "Instantaneous Normal Mode Analysis of Supercooled Water", *Physical Review Letters* 2000 May 15; 84(20):4605-4608.
- Lee, B. P.; Douglas, J. F., and Glotzer, S. C., "Filler-Induced Composition Waves in Phase-Separating Polymer Blends", *Physical Review E* 1999 Nov; 60(5):5812-5822.
- Lee, H. J.; Lin, E. K.; Lan, J. K.; Cheng, Y. L.; Liou, H. C.; Wu, W. L.; Wang, Y. L.; Feng, M. S., and Chao, C. G., "Investigation of N₂ Plasma Effects on the Depth Profile of Hydrogen Silsesquioxane Thin Films Using High Resolution Specular X-Ray Reflectivity", *Proc. of the 2000 Intl. Conf. on Characterization and Metrology for ULSI Technology* 2000.
- Lenhart, J. L.; Van Zanten, J. H.; Dunkers, J. P., and Parnas, R. S., "Interfacial Response of a Fluorescent Dye Grafted to Glass", *Langmuir* 2000 Oct 17; 16(21):8145-8152.
- Lenhart, J. L.; Van Zanten, J. H.; Dunkers, J. P.; Zimba, C. G.; James, C. A.; Pollack, S. K., and Parnas, R. S., "Immobilizing a Fluorescent Dye Offers Potential to Investigate the Glass/Resin Interface", *Journal of Colloid and Interface Science* 2000 Jan 1; 221(1):75-86.
- Lenhart, J. L.; vanZanten, J. H.; Dunkers, J., and Parnas, R., "A Practical Fiber Optic Sensor to Monitor Resin Cure and Interphase Formation", *ANTEC 2000 Proceedings*; Orlando, FL.
- Liao, K.; Schultheisz, C. R., and Hunston, D. L., "Effects of Environmental Aging on the Properties of Pultruded GFRP", *Composites Part B-Engineering* 1999; 30(5):485-493.
- Lin, E. K.; Lee, H. J.; Wang, H., and Wu, W. L., "Structure and Property Characterization of Low-k Dielectric Porous Thin Films Determined by X-ray Reflectivity and Small-Angle Neutron Scattering", *Proc. of the 2000 Intl. Conf. on Characterization and Metrology for ULSI Technology* 2000.
- Lin, E. K.; Pochan, D. J.; Wu, W. L., and Satija, S. K., "Neutron reflectivity Measurements of Molecular Mass Effects on Polymer Mobility near the Polymer/Solid Interface", *Proc. of the Materials Research Society Mtg.*
- Lin, E. K.; Wu, W. L.; Jin, C., and Wetzel, J. T., "Structure and Property Characterization of Porous Low-k Dielectric Constant Thin Films using X-ray Reflectivity and Small-angle Neutron Scattering", *Proc. of the Materials Research Society Meeting*.

- Lovell, L. G.; Lu, H.; Stansbury, J. W., and Bowman, C. N., "The Effect of Cure Rate on the Mechanical Properties of Dental Resins", *Journal of Dental Research* 2000; 79:33.
- Majumdar, B. S. and Hunston, D. L., "Continuous Parallel Fiber Composites: Fracture", in *Encyclopedia of Materials: Science and Technology*, ed.: Oxford, England: Pergamon Press; in press.
- Martys, N. S. and Douglas, J. F., "Critical Properties and Phase Separation in Lattice Boltzmann Fluid Mixtures", *Physical Review E* 2000 May.
- McBrearty, M.; Bur, A. J., and Roth, S. C., "Real-Time Dielectric Measurements During Extrusion of Filled Polymers", *Proc. of Annual Technical Meeting of the Society of Plastics Engineers*; Orlando, FL.
- McDonough, W. G.; Antonucci, J. M., and Dunkers, J. P., "Interfacial Shear Strengths of Dental Composites by the Microbond Test", *Dental Composites* in press.
- McDonough, W. G.; Antonucci, J. M.; Schumacher, G. E.; Shimada, Y.; Chiang, M.; He, J., and Dunkers, J. P., "Improvements of a Micro Shear Test for the Study of Adhesion", *Journal of Dental Research* 2000; 79:28.
- McDonough, W. G.; Dunkers, J. P.; Holmes, G. A., and Parnas, R. P., "The Effect of Processing on Interfacial Shear Properties of Composite Materials", *Proc. of the 23rd Annual Meeting of The Adhesion Society*.
- Meredith, J. C. and Amis, E. J., "Lcst Phase Separation in Biodegradable Polymer Blends: Poly(D,L-Lactide) and Poly(Epsilon-Caprolactone)", *Macromolecular Chemistry and Physics* 2000 Apr 14; 201(6):733-739.
- Meredith, J. C.; Karim, A., and Amis, E. J., "High-Throughput Measurement of Polymer Blend Phase Behavior", *Macromolecules* 2000 Aug 8; 33(16):5760-5762.
- Migler, K. B., "Droplet Vorticity Alignment in Model Polymer Blends", *Journal of Rheology* 2000 Mar-2000 Apr 30; 44(2):277-290.
- , "Wall-Induced String Formation in Sheared Polymer Blends", *Physical Review Letters* in press.
- Migler, K. B.; Hobbie, E. K., and Qiao, F., "In Line Study of Droplet Deformation in Polymer Blends in Channel Flow", *Polymer Engineering and Science* 1999 Nov; 39(11):2282-2291.
- Migler, K. B.; Lavallée, C.; Dillon, M. P.; Woods, S. S., and Gettinger, C. L., "Visualizing the elimination of sharkskin through fluoropolymer additives: Coating and polymer-polymer slippage", *Journal of Rheology* in press.
- Misra, D. N., "Interaction of Citric or Hydrochloric Acid With Calcium Fluorapatite: Precipitation of Calcium Fluoride", *Journal of Colloid and Interface Science* 1999 Dec 15; 220(2):387-391.
- Mopsik, F. I., "Extended Frequency Range Dielectric Measurements of Thin Films", *Review of Scientific Instruments* 2000 Jun; 71(6):2456-2460.
- Morgan, A. B.; Antonucci, J. M.; VanLandingham, M.; Harris, R. H., and Kashiwagi, T., "Thermal and Flammability Properties of a Silica-PMMA Nanocomposite", *Proceedings of the ACS Division of Polymeric Materials Science and Engineering* 2000 Aug; 83:57-58.
- Morgan, A. B.; Gilman, J. W.; Harris, R. H.; Jackson, C. L.; Wilkie, C. A., and Zhu, J., "Flammability of Polystyrene-clay Nanocomposites", *ACS PMSE Preprints* 2000; 83:53.
- Morgan, A. B.; Gilman, J. W., and Jackson, C. L., "Characterization of Polymer-Clay Nanocomposites: XRD vs. TEM", *ACS PMSE Preprints* 2000; 82: 270.
- Morgan, A. B.; Gilman, J. W.; Kashiwagi, T., and Jackson, C. L., "Flammability of Polymer-Clay Nanocomposites", *Flame Retardant Chemicals Association Meeting Proceedings*.
- Morgan, A. B.; Gilman, J. W.; Nyden, M., and Jackson, C. L., "New Approaches to the Development of Fire-Safe Materials", *NISTIR 6465*; 2000 Feb.
- Nakatani, A. I., "Phase Separation Kinetics During Shear in Compatibilized Polymer Blends", in *Scattering From Polymers*, ed.: 2000; pp. 405-434.
- Nakatani, A. I.; Chen, W.; Schmidt, R. G., and Han, C. C., "Chain Dimensions in Polysilicate-Filled Poly(Dimethyl Siloxane)", *Polymer* in press.

- Nakatani, A. I.; Ivkov, R.; Papanek, P.; Yang, H., and Gerspacher, M., "Concentration Dependence of Bound Polymer Dynamics by Inelastic Neutron Scattering", ACS PMSE Preprint. 2000.
- , "Inelastic Neutron Scattering from Filled Elastomers", Rubber Chemistry and Technology in press.
- Nisato, G.; Ivkov, R., and Amis, E. J., "Size Invariance of Polyelectrolyte Dendrimers", *Macromolecules* 2000 May 30; 33(11):4172-4176.
- , "Structure of Charged Dendrimer Solutions as Seen by Small-Angle Neutron Scattering", *Macromolecules* 1999 Sep 7; 32(18):5895-5900.
- Nozaki, R. and Obrzut, J., "Permittivity Measurements of Solid Film Dielectrics at Microwave Frequencies", IPC EXPO-00 Technical Conference.
- Nyden, M. R.; VanderHart, D. L., and Alamo, R. G., "The Conformational Structures of Defect-Containing Chains in the Crystalline Regions of Isotactic Polypropylene", *Computational and Theoretical Polymer Science*. in press.
- Obrzut, J. and Chaing, C. K., "Microwave Dielectric Characterization of Polyaniline Composites", *Organic/Inorganic Hybrid Materials*.
- Obrzut, J. and Chiang, C. K., "Dielectric Measurements of Embedded Capacitance Materials", *Embedded Capacitance Project Report* 2000 Aug.
- Obrzut, J.; Chiang, C. K.; Popielarz, R., and Nozaki, R., "Evaluation of Dielectric Properties of Polymer Thin-Film Materials for Application in Embedded Capacitance", NISTIR 6537 2000.
- Okuno, O.; Asaoka, K., and Tesk, J. A., "High-Temperature Investments", in *Dental Materials and their selection*, ed.: 2000.
- Park, J. Y. and McKenna, G. B., "Size and Confinement Effects on the Glass Transition Behavior of Polystyrene/O-Terphenyl Polymer Solutions", *Physical Review B* 2000 Mar 1; 61(10):6667-6676.
- Park, M. S.; Eanes, E. D.; Antonucci, J. M., and Skrtic, D., "Mechanical Properties of Bioactive Amorphous Calcium Phosphate/Methacrylate Composites", *Dental Materials* 1998 Mar; 14(2):137-141.
- Parnas, R. S. and Flynn, K. M., "Recommended Practice Guide for Measuring and Interpreting Permeability", NISTIR 6542; 2000.
- Pillai, K. M.; Tucker, C. L., and Phelan, F. R., "Numerical Simulation of Injection/Compression Liquid Composite Molding. Part 1. Mesh Generation", *Composites Part a-Applied Science and Manufacturing* 2000; 31(1):87-94.
- Pochan, D. J.; Lin, E. K., and Wu, W. L., "Surface Directed Crystallization and Autophobic in Semicrystalline Polymer Thin Films", *Macromolecules* 2000.
- Popielarz, R.; Chiang, C. K.; Nozaki, R., and Obrzut, J., "Preparation and Characterization of Photopatternable BaTiO₃/Polymer Composites", *Organic/Inorganic Hybrid Materials*; San Francisco, CA.
- Pursch, M.; Vanderhart, D. L.; Sander, L. C.; Gu, X. H.; Nguyen, T.; Wise, S. A., and Gajewski, D. A., "C-30 Self-Assembled Monolayers on Silica, Titania, and Zirconia: HPLC Performance, Atomic Force Microscopy, Ellipsometry, and NMR Studies of Molecular Dynamics and Uniformity of Coverage", *Journal of the American Chemical Society* 2000 Jul 26; 122(29):6997-7011.
- Qiao, F.; Migler, K. B., and Han, C. C., "Stability of Blends of Polyether Sulfone with Thermotropic Liquid Crystalline Polymers", *Proc. of the ANTEC 2000 Meeting* 2000.
- Qiao, F.; Migler, K. B.; Hunston, D. L., and Han, C. C., "Reactive Compatibilization and In-line Morphological Analysis of Blends of PET and a Thermotropic Liquid Crystalline Polymer", *Polymer Engineering and Science* in press.
- Sambasivan, S. Fischer D. A. Shen M. C. Tesk J. A. Hsu S. M., "Effects of Annealing on UHMWPE Annealing", *Transactions of 6th World Biomaterials Congress*; Kameuela, HA.
- Sastry, S.; Debenedetti, P. G.; Stillinger, F. H.; Schroder, T. B.; Dyre, J. C., and Glotzer, S. C., "Potential Energy Landscape Signatures of Slow Dynamics in Glass Forming Liquids", *Physica a* 1999 Aug 1; 270(1-2):301-308.

- Scala, A.; Starr, F. W.; La Nave, E.; Sciortino, F., and Stanley, H. E., "Configurational Entropy and Diffusivity of Supercooled Water", *Nature* 2000 Jul 13; 406(6792):166-169.
- Schmidt, G.; Nakatani, A. I.; Butler, P. D.; Karim, A., and Han, C. C., "Shear Orientation of a Viscoelastic Polymer-Clay Solution", *Proc. of the XIIIth Intl. Congress of Rheology*; Cambridge, UK.
- , "Shear Orientation of Viscoelastic Polymer-Clay Solutions Probed by Flow Birefringence and SANS", *Macromolecules* 2000 Oct 3; 33(20):7219-7222.
- Schreyer, A.; Majkrzak, C. F.; Berk, N. F.; Grull, H., and Han, C. C., "Using Polarized Neutrons to Determine the Phase of Reflection From Thin Film Structures", *Journal of Physics and Chemistry of Solids* 1999 Aug-1999 Sep 30; 60(8-9):1045-1051.
- Schultheisz, C. R. and McKenna, G. B., "Simultaneous Measurement of Torque, Axial Normal Force and Volume Change in the NIST Torsional Dilatometer - Experiments and Analysis", *Proc. of the Society of Plastics Engineers Annual Technical Conference* 2000.
- , "Standard Reference Materials: Non-Newtonian Fluids for Rheological Measurements", *Proc. of the Society of Plastics Engineers Annual Technical Conference* 2000.
- Shen, M. C. Hsu S. M. Tesk J. A. and Christou A., "Wear Analysis of UHMWPE Using a Load Sum Method", *Transactions of 6th World Biomaterials Congress*; Kameuela, HA.
- Shimada, Y.; Antonucci, J. M.; Schumacher, G. E.; McDonough, W. G., and Tagami, J., "Micro-Shear Bond Strength of Resin Bonding Systems to Enamel Surfaces", *Journal of Dental Research* 2000; 79:3629.
- Simon, Jr. C. G.; Holloway, P. W., and Gear, A. R. L., "Exchange of C₁₆-Ceramide Between Phospholipid Vesicles", *Biochemistry* 1999 Nov 2; 38(44):14676-14682.
- Skrtic, D.; Antonucci, J. M., and Eanes, E. D., "Effect of the Monomer and Filler Systems on the Remineralizing Potential of Bioactive Dental Composites Based on Amorphous Calcium Phosphate", *Polymers for Advanced Technologies* 2000 Jun 1.
- Skrtic, D.; Antonucci, J. M.; Eanes, E. D.; Eichmiller, F. C., and Schumacher, G. E., "Physicochemical Evaluation of Bioactive Polymeric Composites Based on Hybrid Amorphous Calcium Phosphates", *Journal of Biomedical Materials Research* 2000 Aug; 53(4):381-391.
- Skrtic, D.; Antonucci, J. M.; Eichmiller, F. C., and Stansbury, J. W., "Polymerization Shrinkage and Methacrylate Conversion in Amorphous Calcium Phosphate Composites", *Journal of Dental Research* 2000; 79:1781.
- Smith, A. P.; Carson, J. C.; Amis, E. J., and Karim, A., "Morphological Characterization of Symmetric Copolymers Via Novel Combinatorial Methods", *Abs. of 2000 ACS Natl. Mtg.*, Washington, DC, August, 2000 2000.
- Snyder, C. R., "High Sensitivity Technique for Measurement of Thin Film Out-of-Plane Expansion. II. Conducting and Semiconducting Samples", *Proc. of the 2000 International Conf. on Characterization and Metrology for ULSI Technology*.
- Snyder, C. R. and Douglas, J. F., "Determination of the Dielectric Constant of Nanoparticles. I. Dielectric Measurements of Buckminsterfullerene Solutions", *Journal of Physical Chemistry, Part B*. 2000 Nov; 104(47):11058-11065.
- Snyder, C. R.; Mopsik, F. I.; Marand, H.; Alizadeh, A., and Sohn, S. M., "Time-Domain Dielectric Spectroscopy Analysis of the Amorphous Phase in Semicrystalline Polycarbonate", *Abstracts of Papers of the American Chemical Society* 1999 Aug 22; 218:139-PMSE.
- Soles, C. L.; Lin, E. K.; Wu, W.-L.; Zhang, C., and Laine, R. L., "Structural Evolution of Silsesquioxane-based Organic/Inorganic Nanocomposite Networks", *Proc. of the Materials Research Society Annual Meeting*.
- Stansbury, J. W.; Tanaka, J., and Antonucci, J. M., "Photopolymerization Studies and Polymer Properties of Methacrylate/Vinyl Ester Resins", *Journal of Dental Research* 2000; 79:2896.
- Starr, F. W.; Nielsen, J. K., and Stanley, H. E., "Hydrogen-Bond Dynamics for the Extended Simple Point-Charge Model of Water", *Physical Review E* 2000 Jul; 62(1):579-587.

- Starr, F. W.; Sciortino, F., and Stanley, H. E., "Dynamics of Simulated Water Under Pressure", *Physical Review E* 1999 Dec; 60(6):6757-6768.
- Tanaka, J.; Stansbury, J. W., and Antonucci, J. M., "New Hydrophobic Diluent Monomers for UDMA and/or Bis-GMA", *Journal of Dental Research* 2000; 79:1788.
- Tesk, J. A., "NIST Reference Material for UHMWPE", *Biomaterials Forum* 2000; Nov-Dec:12.
- , "NIST - SFB Workshop Identifies Needs for Reference Data and Reference Materials", *Biomaterials Forum* 2000; Nov-Dec:11.
- Thomas, C. L. and Bur, A. J., "In-Situ Monitoring of Product Shrinkage During Injection Molding Using an Optical Sensor", *Polymer Engineering and Science* 1999 Sep; 39(9):1619-1627.
- Topp A; Bauer BJ; Klimash JW; Spindler R; Tomalia DA, and Amis EJ, "Probing the location of the terminal groups of dendrimers in dilute solution", *Macromolecules* 1999 Oct 19; 32(21):7226-7231.
- Topp A; Bauer BJ; Prosa TJ; Scherrenberg R, and Amis, EJ, "Size change of dendrimers in concentrated solution", *Macromolecules* 1999 Dec 28; 32(26):8923-8931.
- Topp A; Bauer BJ; Tomalia DA, and Amis EJ, "Effect of solvent quality on the molecular dimensions of PAMAM dendrimers", *Macromolecules* 1999 Oct 19; 32(21):7232-7237.
- Vanderhart, D. L.; Alamo, R. G.; Nyden, M. R.; Kim, M. H., and Mandelkern, L., "Observation of Resonances Associated With Stereo and Regio Defects in the Crystalline Regions of Isotactic Polypropylene: Toward a Determination of Morphological Partitioning", *Macromolecules* 2000 Aug 8; 33(16):6078-6093.
- Vanderhart, D. L.; Feng, Y.; Han, C. C., and Weiss, R. A., "Morphological Characterization of Blends of Metal-Sulfonated Poly(Styrene) and a Methylated Poly(Amide) by Solid State NMR", *Macromolecules* 2000 Mar 21; 33(6):2206-2227.
- VanderHart, D. L.; Nyden, M. R., and Alamo, R. G. and Mandelkern L., "Incorporation of Stereo, Regio and Comonomer Defects into the Crystalline Regions of Isotactic Polypropylene: Results from NMR, Molecular Dynamics and Chemical Shift Calculations", Preprint of the American Chemical Society National Meeting in San Francisco, March, 2000. 2000.
- VanderHart, D. L.; Schen, M. A., and Davis, G. T., "Partitioning of Water between Voids and the Polymer Matrix in a Molding Compound by Proton NMR", *International Journal of Microcircuits and Electronic Packaging* 1999; 22:424-439.
- Viers BD; Bauer BJ; Akpalu Y; Grohn F; Liu D-W, and Kim G, "Hydrogels formed by end-linking PEG to dendrimer cross-link agents", *ACS Polymer Preprints* 2000; 41(1):728-729.
- Von Gonten, A. S.; Kelly, J. R., and Antonucci, J. M., "Load-Bearing Behavior of a Simulated Craniofacial Structure Fabricated From a Hydroxyapatite Cement and Bioresorbable Fiber-Mesh", *Journal of Materials Science-Materials in Medicine* 1999; 11(2):95-100.
- Wallace, W. E.; Guttman, C. M., and Antonucci, J. M., "Maldi-Tof Mass Spectrometry of Polymeric Silsesquioxanes", *Abstracts of Papers of the American Chemical Society* 2000 Mar 26; 219:20-POLY.
- , "Polymeric Silsesquioxanes: Degree-of-Intramolecular-Condensation Measured by Mass Spectrometry", *Polymer* 2000 Mar; 41(6):2219-2226.
- Wu, W.; Lin, E. K.; Jin, C., and Wetzel, J. T., "A Three-Phase Model for the Structure of Porous Thin Films Determined by X-ray Reflectivity and Small Angle Neutron Scattering", *Proc. of the Materials Research Society Meeting*; San Francisco, CA.
- Wu, W. L.; Lin, E. K.; Lin, Q., and Angelopolous, M., "Small-Angle Neutron Scattering Measurements for the Characterization of Lithographically Prepared Structures", *Proc. of the 2000 Intl. Conf. on Characterization and Metrology for ULSI Technology*.
- Wu, W.-L.; Lin, E. K.; Lin, Q., and Angelopolous, M., "Small Angle Neutron Scattering Measurements of Nanoscale Lithographic Features", *J. Appl. Phys.* 2000; 88(12).

- Wu, W. L.; Wallace, W. E.; Lin, E. K.; Lynn, G. W.; Glinka, C. J.; Ryan, E. T., and Ho, H. M., "Properties of Nanoporous Silica Thin Films Determined by High-Resolution X-Ray Reflectivity and Small-Angle Neutron Scattering", *Journal of Applied Physics* 2000 Feb 1; 87(3):1193-1200.
- Xu, H. H. K.; Eichmiller, F. C.; Antonucci, J. M., and Flaim, G. M., "Single-Crystalline Ceramic Whisker-Reinforced Carboxylic Acid- Resin Composites With Fluoride Release", *Operative Dentistry* 2000 Mar-2000 Apr 30; 25(2):90-97.
- Xu, H. H. K.; Eichmiller, F. C.; Antonucci, J. M.; Schumacher, G. E., and Ives, L. K., "Dental Resin Composites Containing Ceramic Whiskers and Precured Glass Ionomer Particles", *Dental Materials* 2000 Sep; 16(5):356-363.
- Xu, H. H. K.; Giuseppetti, A. A.; Eichmiller, F. C.; Antonucci, J. M.; Schumacher, G. E., and Flaim, G. M., "Composites Containing Ceramic Whiskers and Precured Glass Ionomer Particles", *Journal of Dental Research* 2000; 79:1787.
- Xu, H. H. K.; Smith, D. T.; Schumacher, G.; Eichmiller, F. C., and Antonucci, J. M., "Indentation Modulus and Hardness of Whisker-Reinforced Heat- Cured Dental Resin Composites", *Dental Materials* 2000 Jul; 16(4):248-254.
- Xu, H. H. K.; Smith, D. T.; Schumacher, G. E.; Eichmiller, F. C.; Antonucci, J. M., and Stansbury, J. W., "Whisker-Reinforced Composites: Effects of Filler Level, Heat- Cure Temperature and Time", *Journal of Dental Research* 2000; 79:3640.
- Zhang, K. J.; Briggs, M. E.; Gammon, R. W.; Sengers, J. V., and Douglas, J. F., "Thermal and Mass Diffusion in a Semidilute Good Solvent-Polymer Solution", *Journal of Chemical Physics* 1999 Aug 1; 111(5):2270-2282.
- Zhang, Y.; Douglas, J. F.; Ermi, B. D., and Amis, E. J., "Influence of Counterion Valency on the Scattering Properties of Highly Charged Polyelectrolyte Solutions", *J. of Chemical Physics* in press.

Polymers Division

Chief

Eric J. Amis
Phone: 301-975-6762
E-mail: eric.amis@nist.gov

Deputy Chief

Bruno M. Fanconi
Phone: 301-975-6769
E-mail: bruno.fanconi@nist.gov

NIST Fellow

Charles C. Han
Phone: 301-975-6772
E-mail: charles.han@nist.gov

Group Leaders

Electronics Materials
Wen-Li Wu
Phone: 301-975-6839
E-mail: wen-li.wu@nist.gov

Biomaterials
Francis W. Wang
Phone: 301-975-6726
E-mail: francis.wang@nist.gov

Multiphase Materials
Charles Han

Multivariant Measurement Methods
Alamgir Karim
Phone: 301-975-6588
E-mail: alamgir.karim@nist.gov

Characterization and Measurement
Method Development
Wen-li Wu

Standards and Data
Bruno Fanconi

Internal Capabilities
Eric J. Amis, Acting

Processing Characterization
Kalman Migler
Phone: 301-975-4876
E-mail: kalman.migler@nist.gov

Research Staff

Akpalu, Yvonne⁺

yvonne.akpalu@nist.gov

Crystallization, structure and morphology of polymers
Small angle and wide angle x-ray scattering
Thin film phase behavior of polymer blends

Amis, Eric J.

eric.amis@nist.gov

Neutron, x-ray and light scattering
Polyelectrolytes
Viscoelastic behavior of polymers
Dendrimers and dendritic polymers
Functional Biomaterials

Antonucci, Joseph M.

joseph.antonucci@nist.gov

Synthetic and polymer chemistry
Dental composites, cements and adhesion
Initiator systems
Interfacial coupling agents
Remineralizing polymer systems

Ashley, Karen⁺

karenmashley@hotmail.com

Polymer Thin Films
Dewetting
Combinatorial Measurements

Balizer, Edward⁺

Neutron, x-ray scattering
Polymer electrostriction

Barnes, John D.

john.barnes@nist.gov

Gas and vapor transport in polymers
X-ray scattering
Computer applications in polymer measurements

Barnes, Kathleen A.⁺

kathleen.barnes@nist.gov

Polymer blends, polymer/filler interactions
Thin film phase behavior

Neutron scattering, AFM, optical microscopy and
Rheology

Bauer, Barry J.

barry.bauer@nist.gov

Polymer synthesis Thermal characterization
Neutron, x-ray and light scattering
Dendrimers, metallic ions nanocluster

Beers, Kathryn

kathryn.beers@nist.gov

Crystallization in thin films
Optical light scattering
Controlled/living polymerizations

Blair, William R.

william.blair@nist.gov

Polymer analysis by size exclusion
Chromatography Diffusion and absorption of gases in
Polymeric matrices
Mass spectrometry of polymers

Bowen, Rafael L.*

rafael.bowen@nist.gov

Adhesion
Dental composites
Novel Monomer Synthesis

Bur, Anthony J.

Anthony.bur@nist.gov

Dielectric properties of polymers
Fluorescence and optical monitoring of polymer
processing
Piezoelectric, pyroelectric polymers
Viscoelastic properties of polymers

Cantoni, Giovana⁺

giovanna.cantoni@nist.gov

Biomaterials and biopolymers
Polymer thin films
Tissue engineering

- Carey, Clifton M.*
 clifton.carey@nist.gov
 Dental plaque
 Microanalytical analysis techniques
 Phosphate chemistry
 Ion-selective electrodes
- Chang, Shu Sing⁺
 Thermal properties of polymeric and composite materials
 Composite process monitoring
 Electronic packaging materials
 Polymer phase transitions
 Precision electrical and temperature measurements
- Chen, Erqiang⁺
erqiang_chen@hotmail.com
 Polymer morphology
 Phase behavior of block copolymers
 Polymer blends
- Chen, Wei⁺
wchen2.email.com@dcrn.e-mail.com
 X-ray and neutron scattering
 Low dielectric constant material characterization
- Cherng, Maria*
 maria.cherng@nist.gov
 Calcium phosphate biomaterials
- Chiang, Chwan K.
 c.chiang@nist.gov
 Electroluminescent polymers
 Residual stress
 Impedance spectroscopy
- Chiang, Martin Y.
 martin.chiang@nist.gov
 Computational mechanics (finite element analysis)
 Strength of materials, Fracture Mechanics
 Engineering mechanics of polymer based materials
 Bi-material interface
- Chow, Laurence C.*
 laurence.chow@nist.gov
 Calcium phosphate compounds and biomaterials
 Dental and biomedical cements
 Solution chemistry
 Topical dental fluorides
- Crosby, Alfred
 alfred.crosby@nist.gov
 Polymer Adhesion
 Polymer Fracture
 Viscoelasticity
 Elastomers
- Block copolymers
- Dähnhardt, Jan-Erik⁺
 Self-curing dental repair resin
- Davis, G. Thomas⁺
 george.davis@nist.gov
 Electronic packaging
 Polymer crystallization
 X-ray diffraction of polymers
 Polarization distribution
 Piezoelectricity in polymers
- DeReggi, Aime S
 aime.dereggi@nist.gov
 Polarization-depth profiles in polymers
 Space charge in dielectrics
 Ferroelectric polymers
 Polymeric piezo- & pyroelectric devices
- Dickens, Sabine*
 sabine.dickens@nist.gov
 Dental composites
 Dental adhesives
 Transmission electron microscopy
- Di Marzio, Edmund A.⁺
 edmund.dimarzio@nist.gov
 Statistical mechanics of polymers
 Phase transitions
 Glasses
 Polymers at interfaces
- Douglas, Jack F.
 jack.douglas@nist.gov
 Theory on polymer solutions, blends, and filled polymers
 Transport properties of polymer solutions and suspensions
 Polymers at interfaces
 Scaling and renormalization group calculation
- Dunkers, Joy P.
 joy.dunkers@nist.gov
 Optical coherence tomography
 Image analysis
 Fiber optic spectroscopy
 Infrared microspectroscopy of polymers
- Eanes, Edward D.⁺
 edward.eanes@nist.gov
 Structure of bones and teeth
 Calcium phosphate compounds as dental materials
 Effects of solution and biological molecules on precipitation of calcium phosphates
 Liposome studies

Eichmiller, Frederick C.*
 frederick.eichmiller@nist.gov
 Clinical dentistry
 Composites
 Dentin adhesives

Eidelman, Naomi N.*
 Naomi.eidelman@nist.gov
 Prevention of calcification in the cardiovascular system
 Effect of phosphonates, cholesterol and phospholipids on calcium phosphate formation
 Characterization of calcified deposits by FTIR microscopy

Esker, Alan R.⁺
 alan.esker@nist.gov
 Membrane mediated polymer interdiffusion
 Phase separation kinetics of polymer blends

Fanconi, Bruno M.
 bruno.fanconi@nist.gov
 Infrared & Raman spectroscopy of polymers
 Structure of polymers
 Polymer fracture
 Process monitoring of polymer composites

Feresenbet, Elias⁺
 Silane deposition
 Composite interfaces

Flaim, Glenn M.*
 glenn.flaim@nist.gov
 Fabricating dental composites

Floyd, Cynthia J. E.⁺
 cynthia.floyd@nist.gov
 Dental composites

Flynn, Kathleen M.
 kathleen.flynn@nist.gov
 Permeability measurements and database
 Flow visualization experiments
 Web page development

Fowler, Bruce O.⁺
 bruce.fowler@nist.gov
 Infrared and Raman spectroscopy
 Structure of calcium phosphates, bones, and teeth
 Composites

Frukhtbeyn, Stanislav⁺
 Calcium phosphate compounds and biomaterials
 Topical dental fluorides

Galvin, Agnes Ly.*
 agnes.galvin@nist.gov
 Clinical dental assistant
 Adhesion measurements

George, Laurie A.*
 laurie.george@nist.gov
 Glass-ceramics

Giuseppetti, Anthony A.*
 anthony.giuseppetti@nist.gov
 Casting of dental alloys
 Mercury-free amalgam alternative

Glotzer, Sharon C.
 sharon.glotzer@nist.gov
 Theoretical and computational materials science
 Disordered systems and pattern formation
 Dynamics and structure in soft materials
 Liquid crystals glasses

Groehn, Franziska⁺
 franziska.groehn@nist.gov
 Neutron and x-ray scattering
 Electron microscopy
 Dendrimers
 Nanocomposites
 Nanocrystals
 Organic-inorganic hybrids

Guttman, Charles M.
 charles.guttman@nist.gov
 Solution properties of polymers
 Size exclusion chromatography
 Mass spectroscopy of polymers
 Diffusion and absorption of gases by polymers

Han, Charles C.
 charles.han@nist.gov
 Phase behavior of polymer blends
 Phase separation kinetics of polymer blends
 Polymer characterization and diffusion
 Shear mixing/demixing and morphology control of polymer blends
 Static, time resolved, and quasi-elastic scattering of light and neutron

Jinamei He
 jianmei.he@nist.gov
 Computational mechanics (finite element modeling)
 Adhesive joints
 Structural optimization

Hedden, Ronald

ronald.hedden@nist.gov

Siloxane polymers: synthesis and properties of monomers, linear chains, and networks
Mechanical properties of elastomers
Polymer fractionation
Gel permeation chromatography

Hirayama, Satoshi⁺

satoshi.hirayama@nist.gov

Calcium phosphate cement
Biocompatibility

Hobbie, Erik K.

erik.hobbie@nist.gov

Light scattering and optical microscopy
Dynamics of complex fluids
Shear induced structures in polymer blends and solutions

Holmes, Gale A.

gale.homes@nist.gov

Composite interface science
Chemical structure-mechanical property relationships for polymers
Polymer chemistry
Mass spectroscopy

Hotta, Yasuhiro⁺

yasuhiro.hotta@nist.gov

Dental CAD/CAM
Investment for titanium casting
Fluorescence spectroscopy

Hunston, Donald L.

donald.hunston@nist.gov

Adhesion science and technology
Fracture behavior of polymers
Processing and failure behaviors of polymer composites
Flow behavior of dilute high polymer solutions
Macromolecular-small molecule binding
Hybrid reinforced composites

Hussain, Latiff*

latiff.hussain@nist.gov

Monomer polymer synthesis, characterization, testing
Dental composites, adhesives

Jackson, Catheryn L.

catheryn.jackson@nist.gov

Structure and morphology of polymers
Transmission and scanning electron microscopy
Finite-size effects on crystalline melting and glass transition temperatures
Liquid crystalline polymers

Microcellular foams morphology

Atomic force microscopy

Jeon, Hyun Sik⁺

hyunsik.jeon@nist.gov

Shear light scattering and optical microscopy
Structure and morphology of two-phase elastomer blends under shear

Jones, Ronald⁺

ronald.jones@nist.gov

Neutron and x-ray scattering
Neutron reflectivity
Polymer surfaces and thin films
Polymer phase transitions and computer simulation

Karim, Alamgir

alamgir.karim@nist.gov

Polymer fillers and nanocomposites
Patterning of thin polymer blend films on inhomogenous surfaces
Neutron and x-ray reflection, scattering, AFM and optical microscopy
Thin film phase behavior of polymer blends
Combinatorial thin film polymer coatings

Kelly, J. Robert⁺

robert.kelly@nist.gov

Calcium phosphate cements
Dental ceramics
Failure analysis; dental prostheses
Finite element analysis
Weibull analysis

Khatri, Chetan A.⁺

Chetan.khatri@nist.gov

Monomer/polymer synthesis and characterization

Khoury, Freddy A.

freddy.khoury@nist.gov

Crystallization, structure and morphology of polymers
Analytical electron microscopy of polymers
Wide angle and small angle x-ray diffraction
Structure and mechanical property relationships

Kim, Ginam⁺

ginam.kim@nist.gov

Structure and morphology of polymers
Transmission and scanning electron microscopy
Cryo-electron microscopy

Kryder, Samuel J.⁺

Electronic circuit design and construction
Electronic troubleshooting and repair

Staff

Kueh, Sylvia⁺

Liquid molding
Optical fiber sensors

Kumar, Sanat⁺

kumar@plmsc.psu.edu
Polymer coatings and thin films
Simulations
Physical properties of polymers
Phase Separation
Multiphase polymer systems

Lee, Hae-Jeong⁺

hae-jeong.lee@nist.gov
X-ray reflectivity
Small angle neutron scattering
Synthesis and characterization of low dielectric constant thin films

Lenhart, Joseph L.

joseph.lenhart@nist.gov
Sensors
Interphase structure

Li, Bizhong⁺

Polymer processing
Polymer blends
Polymer-clay processing

Liao, Nam S.*

nam.liao@nist.gov
Synthesis and testing of dental adhesives
Internal stress of composition due to polymerization

Lin, Eric K.

eric.lin@nist.gov
Statistical mechanics
X-ray and neutron reflectivity

Liu, D.-W.

da-wei.liu@nist.gov
Polymer synthesis
Thermal gravimetric analysis
Differential scanning calorimetry
Gel permeation chromatography
Infrared spectroscopy
Nuclear magnetic resonance
Scanning electron microscopy
Atomic force microscopy

Lynn, Gary W.⁺

gary.lynn@nist.gov
X-ray and neutron reflectivity
Optical microscopy

Mager, Carie⁺

carie.mager@nist.gov
Toughening Bioceramics
Fracture mechanics

Markovic, Milenko*

milenko.markovic@nist.gov
Calcium phosphate chemistry
Biomineralization (normal and pathological)
Crystal growth and dissolution kinetics
Heterogeneous equilibria

Mathew, Mathai*

mathai.mathew@nist.gov
Crystallography
Calcium phosphate compounds

Maurey, John M.⁺

john.maurey@nist.gov
Ultracentrifugation
Rayleigh light scattering
Osmometry
Densimetry
Refractometry
Intrinsic viscosity

McDonough, Walter G.

walter.mcdonough@nist.gov
Processing and cure monitoring polymer composites
Failure and fracture of polymers
Polymer composite interfaces

McKenna, Gregory B.⁺

greg.mckenna@coe.ttu.edu
Failure, yield and fracture of polymers
Nonlinear viscoelasticity
Molecular rheology
Physics of polymer glasses
Rubber thermodynamics and mechanics
Mechanics of composites

Meredith, J. Carson

james.meredith@nist.gov
Biodegradable polymer blends
Phase-separation and wetting properties of thin films
Combinatorial methods for coatings

Migler, Kalman

kalman.migler@nist.gov
Effects of shear and pressure on phase behavior
Fluorescence and optical monitoring of polymer processing
Liquid crystals
Shear induced two phase structures
Polymer slippage

- Mopsik, Frederick I.⁺
frederick.mopsik@nist.gov
 Dielectric measurements and behavior
 Automated measurement design
 Computerized data analysis and programming
 Electrical properties of polymers
- Mueller, Herbert J. *
herb.mueller@nist.gov
 Dental Biomaterials
 Interfacial interactions via electrochemical and infrared spectroscopy
 Chevron notch fracture toughness
 Mechanical properties via nondestructive methods
- Nakatani, Alan I.
alan.nakatani@nist.gov
 Polymer blends and solution properties under shear
 Small angle neutron scattering
 Phase behavior of polymer blends
 Filled polymers
 Rheo-optical behavior of polymers
- Noda, Natsuko⁺
noda@nist.gov
 Impedence spectroscopy
 Dielectric characterization of composites
- Nozaki, Ryusuke⁺
nozaki@charco.sci.hokudai.ac.jp
 Dielectric relaxation in polymers
 Impedence spectroscopy
- Obrzut, Jan
jan.obrzut@nist.gov
 Electronic properties of polymers and composites
 Photoelectron spectroscopy (X-ray and UV)
 Dielectric relaxation spectroscopy
 Electronic packaging
 Reliability, stress testing
 Microwave and optical waveguides
- Parnas, Richard S.
richard.parnas@nist.gov
 Flow through porous media with heterogeneous structure
 Surface rheology
 Polymer dynamics
 Evanescent wave optical fiber fluorescence monitoring
 Control of the liquid molding process
- Parry, Edward E.*
edward.parry@nist.gov
 Dental appliance and crown and bridges fabrication
 Machine shop applications
- Pfeiffer, Carmen⁺
carmen.pfeiffer@nist.gov
 Dental resins
 Monomer synthesis
- Phelan, Jr., Frederick R.
frederick.phelan@nist.gov
 Resin transfer molding: modeling and processing studies
 Viscoelastic flow modeling
 Flow in porous media
 Lattice Boltzmann methods
- Pochan, Darrin⁺
pochan@udel.edu
 SEM & TEM of polymeric materials
 Wide-angle and small-angle x-ray scattering
 Block copolymer phase behavior
- Popielarz, Roman⁺
Roman.Popielarz@nist.gov
 Polymer synthesis and characterization
 Photo-polymerization
- Qiao, Fang⁺
 Polymer mixing and compounding
 Liquid crystalline polymer/thermal plastic polymer mixing
- Roth, Steven C.
steven.roth@nist.gov
 Piezoelectric polymer transducers-fabrication and applications
 Vacuum deposition of metals
 Calibration of polymer transducers
 Microcomputer interfacing
 Fluorescence measurements
- Schmidt, Gudrun⁺
Gudrun.Schmidt@nist.gov
 Polymer blends
 Liquid crystalline polymers
 Polymer-clay interaction
 Light and neutron scattering
- Schultheisz, Carl R.
carl.schultheisz@nist.gov
 Failure of composites
 Experimental mechanics
 Torsional dilatometry
 Physics of polymer glasses
 Polymer rheology

Schumacher, Gary E.*
gary.schumacher@nist.gov
Clinical dentistry
Composites
Dentin adhesives

Sehgal, Amit⁺
amit@nist.gov
Biomaterials, cell-surface biophysics
Polymer thin films
Polyelectrolytes and conducting polymers
Structure and dynamics of polymer solutions
Light scattering and fluorescence photobleaching recovery

Shi, An-Chang⁺
shi@polymer.physics.mcmaster.ca
Colloid theory
Polymer phase transitions

Sieck, Barbara A.*
barbara.sieck@nist.gov
Calcium phosphate compounds
Chemical analysis
Remineralization

Simon, Carl G., Jr.
carl.simon@nist.gov
Biocompatibility
Cytotoxicity
Signaling in human platelets
Bone marrow cell lineage/trafficking

Skrtic, Drago*
drago.skrtic@nist.gov
Calcium phosphates as dental materials
Liposome studies

Smith, Archie⁺
archie.smith@nist.gov
Combinatorial (High-Throughput) Experimental Design and Development
Polymer Crystallization behavior
Thin film Block copolymer behavior
Nanofilled polymer behavior
Electron, Atomic force, X-ray and light microscopies

Snyder, Chad R.
chad.snyder@nist.gov
Polymer crystallization
WAXD and SAXS of polymeric materials
Thermal expansion measurements
Thermal analysis of polymers
Dielectric measurements and behavior

Soles, Christopher
csoles@nist.gov
Viscoelastic properties of polymers
Elastic and inelastic neutron scattering
X-ray and neutron reflectivities
Polymer thin films

Son, Younggon⁺
Younggon.son@nist.gov
Polymer Processing
Polymer Phase Behavior
Interfacial Phenomena

Stansbury, Jeffrey W.
jeffrey.stansbury@nist.gov
Synthetic chemistry
Polymers and polymer composites
Polymerization of expanding monomers
Fluorinated polymers
Polymerization kinetics

Starr, Francis
francis.starr@nist.gov
Dynamics of filled polymers
Slow dynamics in soft condensed matter
Molecular dynamics simulations and parallel computing

Takagi, Shozo*
shozo.takagi@nist.gov
Crystallography
X-ray diffraction
Calcium phosphate biomaterials
Topical fluoridation
De- and remineralization

Tanaka, Jiro⁺
jiro.tanaka@nist.gov
Dental composites
IR & NIR spectroscopies
Mechanical properties

Tesk, John A.
john.tesk@nist.gov
Biomaterials: industrial relations
Bond strength characterization
Casting of alloys
Strength of dental systems
Thermal expansion and properties of dental materials
Finite element studies
Porcelain-metal systems
Weibull analysis
Wear testing, orthopaedic materials
Reference biomaterials

Tung, Ming S.*

ming.tung@nist.gov

Chemistry of calcium phosphate compounds
Remineralization studies
Standard reference materials

VanderHart, David L.

david.vanderhart@nist.gov

Measurement of orientation in polymer fibers and films
Solid state NMR of polymers
Measurement of polymer morphology at the 2-50 nm scale
Pulsed field gradient NMR

Van Zanten, John H.†

jhvanzan@unity.ncsu.edu

Complex fluids
Polymer interfaces
Scattering of light, neutrons & x-rays
Biophysics
Interfacial phenomena
Scanning probe microscopy

Viers, Brent

brent.viers@nist.gov

Polymer gels
Rubber elasticity
Inorganic organic hybrids
Dendrimer networks
Polymer stars
Hydrogels

Vogel, Gerald L.*

gerald.vogel@nist.gov

Dental plaque chemistry, chemistry of calcium phosphates
Microanalytical techniques

Wallace, William E.

william.wallace@nist.gov

Surface and interface behavior
Ion beam and electron spectroscopies
X-ray and neutron reflectivity
MALDI mass spectrometry

Wang, Francis W.

francis.wang@nist.gov

Photophysics and photochemistry of polymers
Fluorescence spectroscopy
Cure monitoring of polymerization
Tissue engineering

Wang, Howard †

hao.wang@nist.gov

Multiple phase transitions in polymer

Wetting, segregation and transport in polymer

Structure and dynamics in polymer gels

Washburn, Newell

newell.washburn@nist.gov

Tissue engineering
Polymer blends
Biomaterial interfaces
Viscoelastic properties of polymers

Weir, Michael

michael.weir@nist.gov

Biomaterials
Tissue engineering
Biodegradable hydrogels
Combinatorial analysis
UV and fluorescence spectroscopy of polymers

Wu, Wen-li

wen-li.wu@nist.gov

Neutron and x-ray scattering and reflectivity
Electron microscopy
Mechanical behavior of polymers and composites
Polymer surfaces and interfaces

Yurekli, Koray†

kyurekli@Jetson.uh.edu

Polymer nanocomposite
Phase separation
Thin films and interfaces
Neutron and light scattering

Xie, Baosheng†

Testing micro tensile and micro-shear bond strength

Xu, Huakun*

hockin.xu@nist.gov

Silver alloy alternative to amalgam
Wear and fatigue
Fiber and whisker reinforcement

Zhang, Yubao†

yubao.zhang@nist.gov

Dynamic light scattering
Polyelectrolytes
Small angle neutron scattering

*Research Associate

†Guest Scientist

Organizational Charts

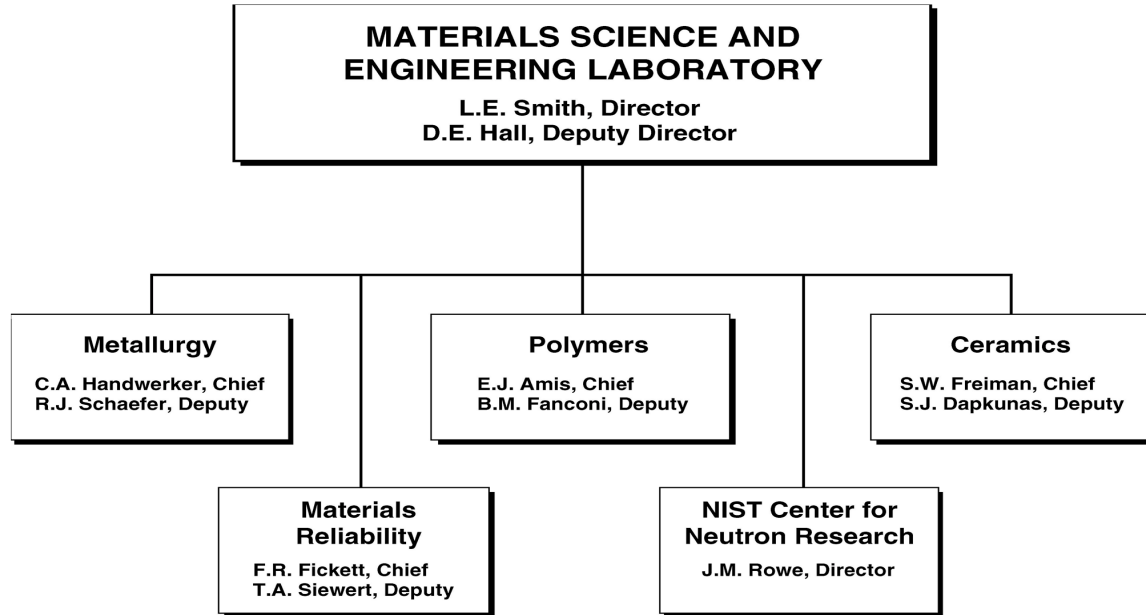

National Institute of Standards and Technology Organizational Chart

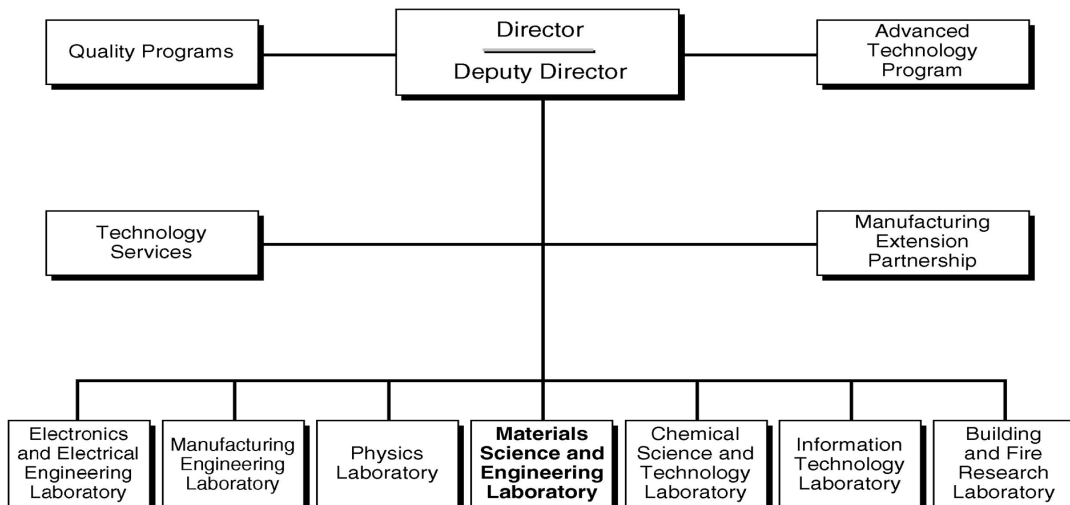

Organizational Charts

Polymers Division
 Eric Amis, Division Chief
 854.00
 Janice Green, Division Secretary

Donna Stutso
 Administrative Officer

Bruno Fanconi
 Deputy Chief

Electronics Materials
 Wen-li Wu, Group Leader
 854.02
 B. Webb, Secretary

C. Chiang
 E. Lin
 J. Obrzut
 C. Snyder

E. Chen
 H. Lee
 N. Noda
 R. Popielarz

Characterization & Measurement
 854.01
 B. Webb, Secretary

Method Development
 Wen-li Wu

M. Chiang
 J. Dunkers
 R. Hedden
 R. Jones
 J. Lenhart
 C. Soles
 F. Starr
 W. Wallace

Standards & Data
 Bruno Fanconi

S. Bhatt
 W. Blair
 C. Guttman
 C. Schultheisz
 J. Tesk

R. Goldschmidt
 J. Maurey
 S. Wetzel

Internal Capabilities
 Eric Amis, Acting

B. Bauer
 A. DeReggi
 J. Douglas
 S. Glotzer
 E. Hobbie
 C. Jackson
 F. Khoury
 D. Liu
 W. McDonough
 P. McGuiggan
 D. VanderHart

Multiphase Materials
 Charles Han, NIST Fellow
 854.04
 J. Burton, Secretary

G. Holmes
 D. Hunston
 A. Nakatani
 F. Phelan

E. Feresenbet
 J. He
 G. Schmidt
 H. Wang

Biomaterials
 Francis Wang, Group Leader
 854.03
 J. Burton, Secretary

J. Antonucci
 J. Hsui
 T. Huang
 C. Simon

C. Khatri
 A. Mizukami
 S. Yoneda

Multivariate Measurement Methods
 Alamgir Karim, Group Leader
 854.06
 K. Hollingsworth, Secretary

K. Beers
 A. Crosby
 N. Washburn
 M. Weir

K. Ashley
 G. Cantoni
 A. Sehgal
 A. Smith
 K. Yurekli

Processing Characterization
 Kalman Migler, Group Leader
 854.05
 K. Hollingsworth, Secretary

A. Bur
 K. Flynn
 S. Roth

F. Qiao
 Y. Son

NISTIR 6596—POLYMERS DIVISION: FY 2000 PROGRAMS AND ACCOMPLISHMENTS