

Building Integration of Micro-Generation Technologies

Assessing Micro-Gen in Italy

Giovanni Angrisani, Carlo Roselli, **Maurizio Sasso**



UNIVERSITA' del SANNIO, Italia
DING (Dipartimento di INGegneria)
Corso di Laurea in Ingegneria Energetica



Aims

 Introduction;

 Commercial status;

 Policy instruments;

 R&D activity;

 Conclusions

MCHP & MCCHP

In the North of Italy small scale cogenerations, MCHP (<15 kWe) is able to guarantee energy savings, avoided CO2 emissions and economic advantages. In the mild climate (South) to increase the annual operation hours, MCHP must be upgraded to provide space and process cooling capacity (MCCHP).

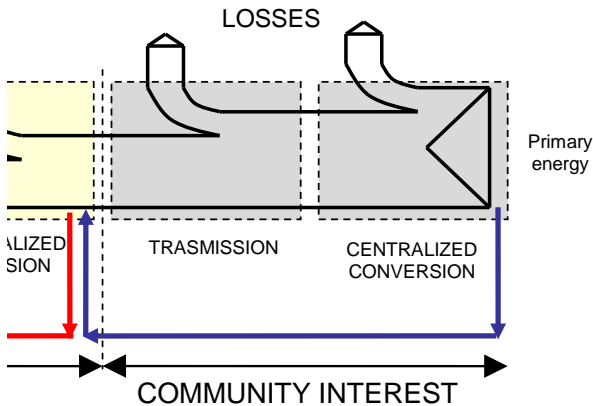

MCCHPs are Distributed Generation systems located close to the point of end use. They can contribute to decrease Transmission and Distribution losses.

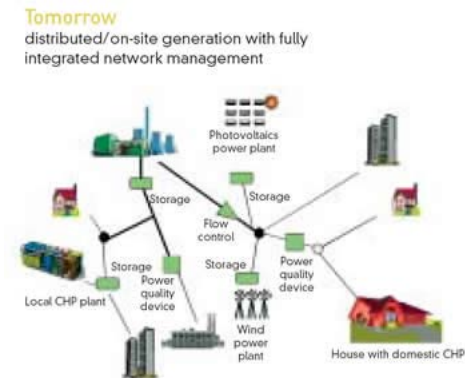

Further benefits of gas fuelled CCHP with respect to the reference separate energy “production” are

- primary energy saving;
- low pollutant emissions;
- reduction of operating costs;
- shift from electricity to gas demands during warm seasons (gas cooling)

CCHP: the components

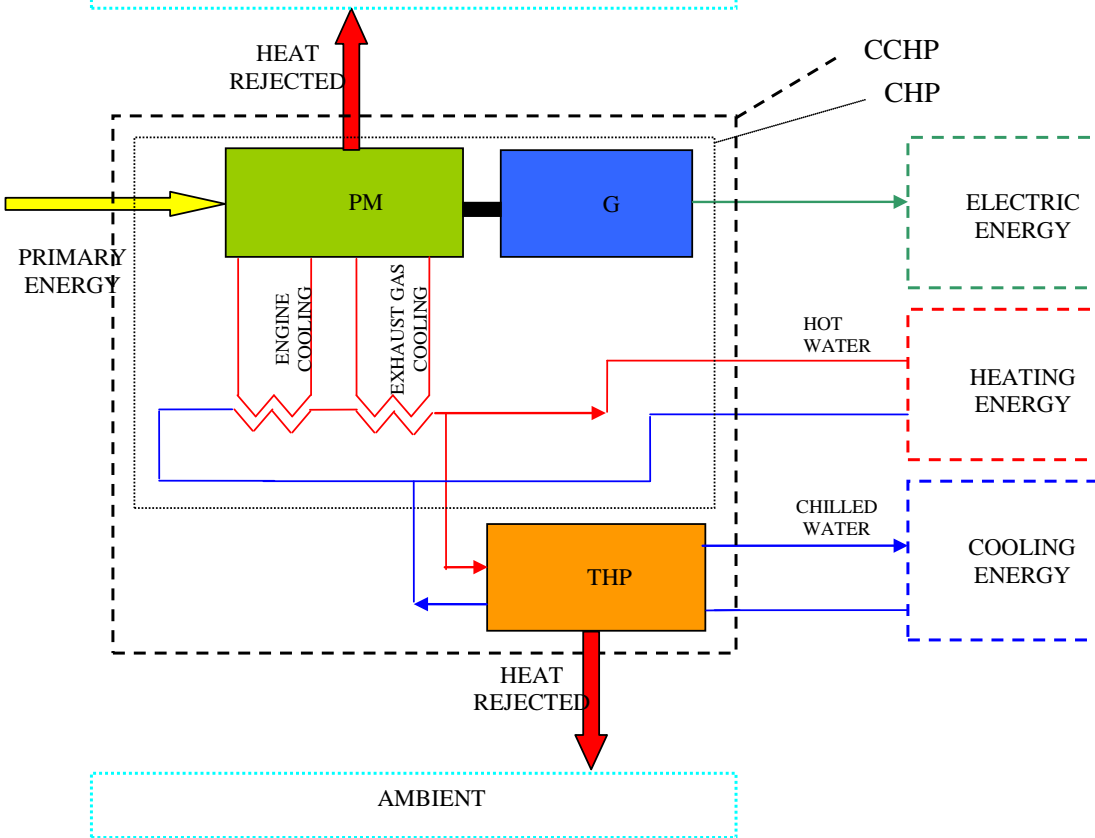

A CCHP consists of four basic components:

- a prime mover;
- an electricity generator, G;
- a thermal recovery system (exhaust gas and engine cooling liquid);
- a cooling energy “production” system.

The “heart” of energy conversion systems, Prime Mover (Stirling, Reciprocating Internal Combustion, Fuel Cell, Gas Turbine):

- stationary conditions for a long time;
- high efficiency and very low pollutant emissions;
- small installation space;
- high thermal efficiency;
- low noise and vibrations levels,
- low maintenance and long life service.

CCHP: the cooling system

It is usually adopted:

- a Thermally activated Heat Pump (absorption and adsorption), **CHP/THP**, fuelled by thermal energy.

Further technologies allow to satisfy cooling demands using CHP mechanical energy outputs:

- mechanically-driven system, **CHP/HP**: an Heat Pump (HP) activated by mechanical energy supplied by PM (Trigeneration Gas Engine Heat Pump);
- electrically-driven system, **CHP/EHP**: a conventional Electric Heat Pump driven by G.

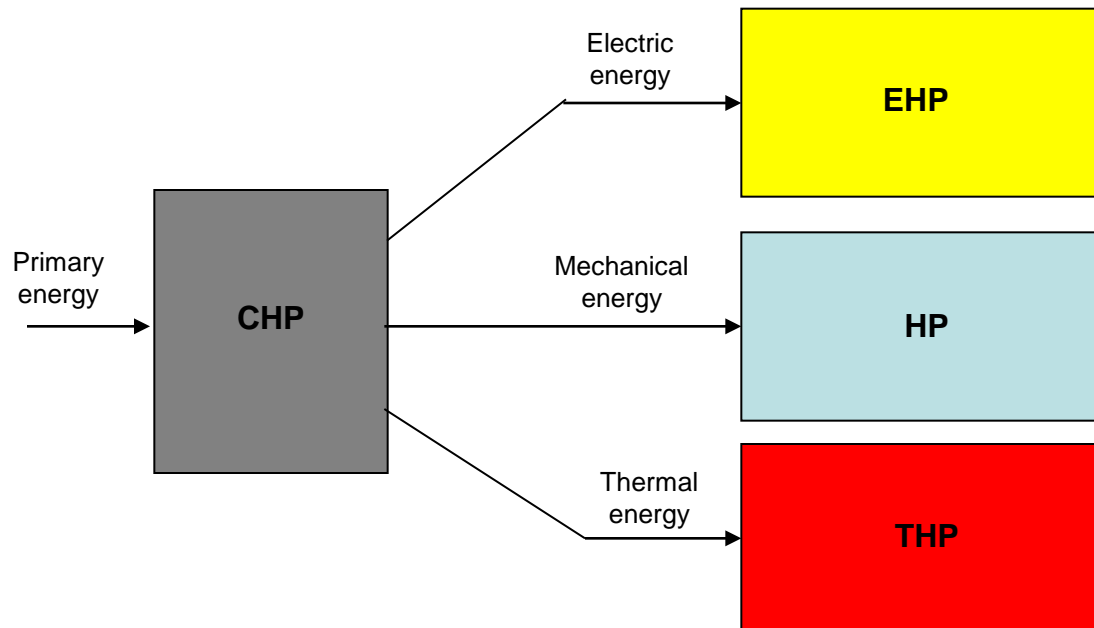

CCHP: non conventional HVAC system based on desiccant wheel

In an air conditioning system outside air is usually cooled below the dew point by a large electric driven compression chiller for dehumidifying and, subsequently, it is heated up to desired supplied temperature.

In a desiccant assisted system, moist air is dehumidified by means of a Desiccant Wheel, DW, increasing overall system energy efficiency by avoiding overcooling air and precluding oversized capacity to meet dehumidification load. The process air stream flows through the desiccant material (such as silica gel) that retains the moisture of the air; the desiccant capacity of this material can be restored through its regeneration via a heated air stream, usually supplied by a boiler.

Advantages:

- sensible and latent loads can be controlled separately;
- the chiller is smaller and it operates at a small temperature lift with a greater COP;
- consistent energy savings can be obtained;
- humidity and IAQ control are better;
- environmental impact is reduced.

The drawbacks of this technology are high investment costs.

The waste heat of a small cogeneration plant can be used effectively to regenerate desiccant material, and also the cogenerator electricity can drive a chiller to meet room sensible load.

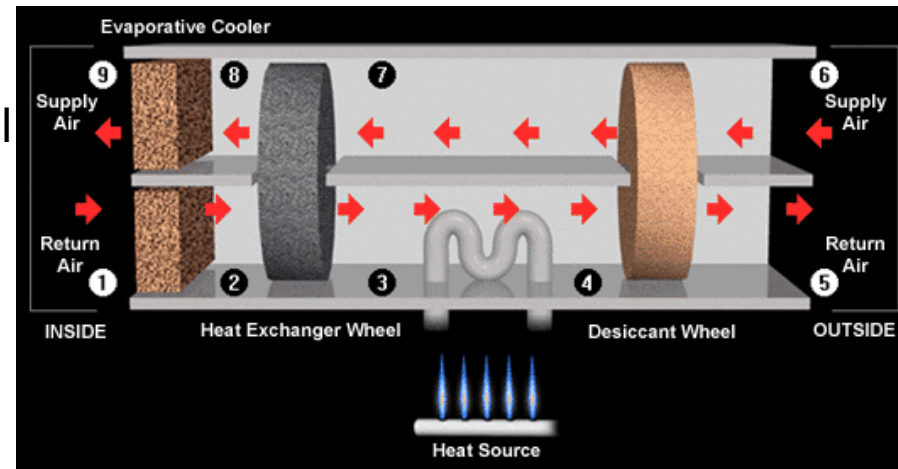

TOTEM: the first MCHP 1/2

In **1973** FIAT group started a research project, headed by Eng. Palazzetti, aimed to develop a MCHP system, the Totem (Total Energy Module) :

- on the market in **1978**;
- 15 kW_{el} and 39 kW_{th} ;
- Internal Combustion Engine:
- natural gas and biogas;
- 903 cm^3 .

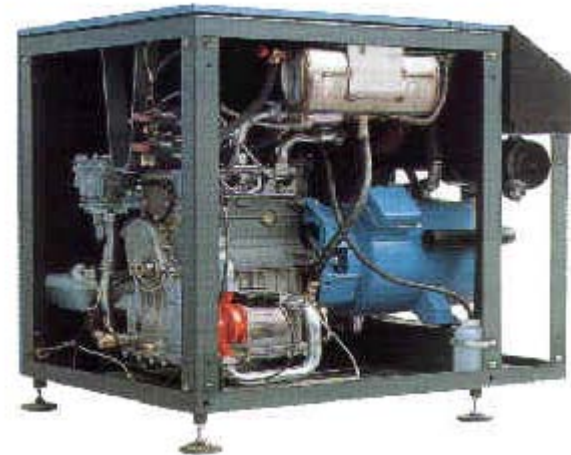

The last version of TOTEM, TANDEM, is based on a FIAT engine with a displacement of 1.200 cm^3 and supplies 20 kW_{el} and 44 kW_{th}

TOTEM: the first MCHP 2/2

Year 1992 MCHP
TOTEM installed:

ITALY 1283 units:

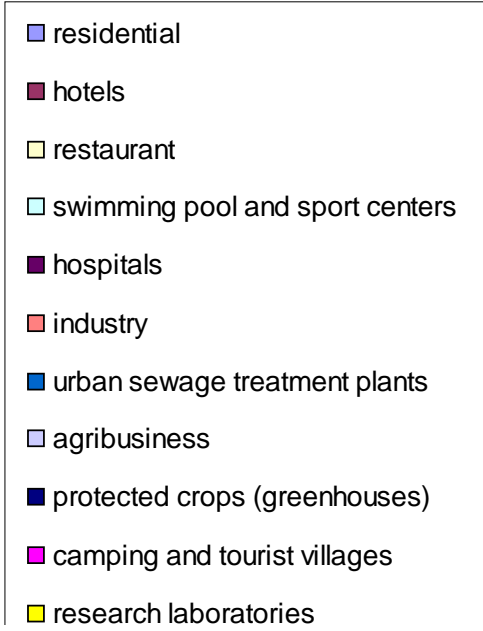
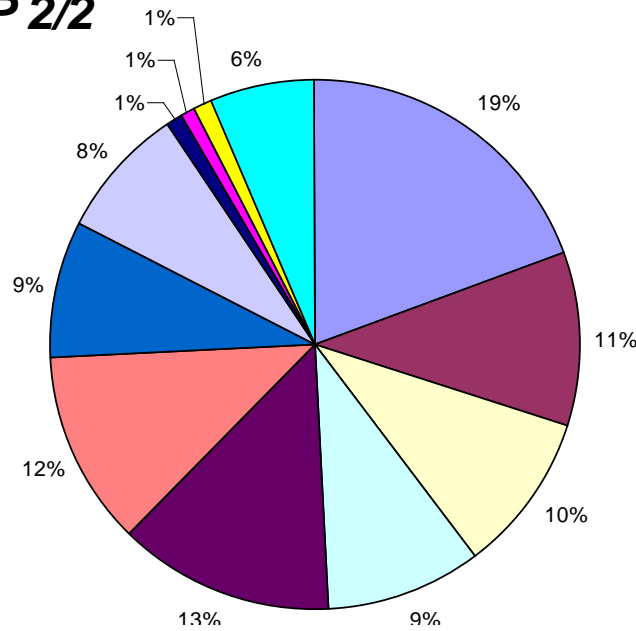

Austria 215
Belgium 70
Denmark 140
Sweden 190
France 140
Germany 300
England 150
Holland 700
Spain 210
Swiss 250
Other countries 100

2465

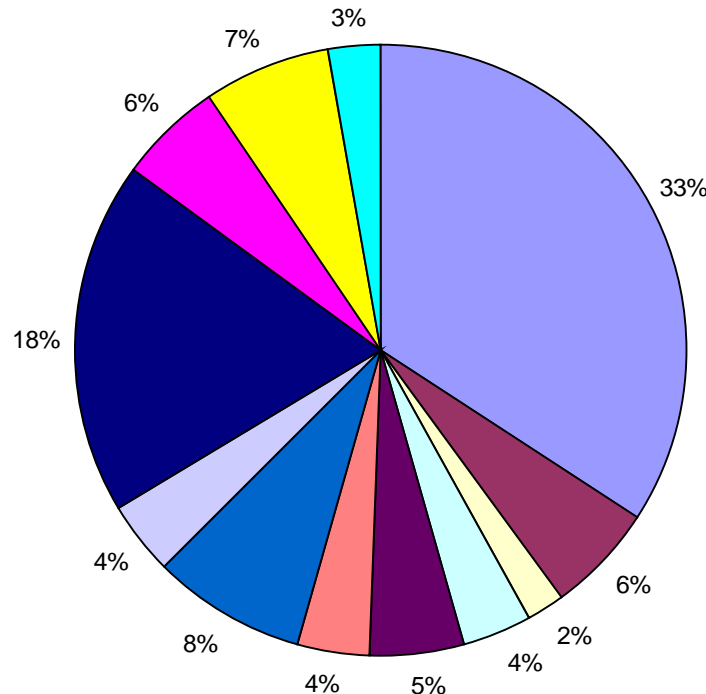

MCHPs (ICE) available on the market

Aisin

Toyota engine, 952 cm³



Power: 6 kW
Thermal power: 11,7 kW
Efficiency
el 28,8%
total 85%

Senertec

Sachs engine, 579 cm³



Power: 5,5 kW
Thermal power: 12,5 kW
Efficiency
el 27%
total 88%

Vaillant-Ecopower

Marathon engine, 272 cm³



Power: 4,7 kW
Thermal power: 12,5 kW
Efficiency
el 25%
total 90%

European Directive

For CHP plants the directive 2004/8/EC introduces the Primary Energy Saving (PES) index:

$$PES = 1 - \frac{1}{\frac{\eta_{el,CHP}}{\eta_{el,PP}} + \frac{\eta_{th,CHP}}{\eta_{th,B}}}$$

- $\eta_{el,CHP}$ annual average electrical efficiency of the CHP;
- $\eta_{th,CHP}$ annual average thermal efficiency of the CHP;
- $\eta_{el,PP}$ reference electrical efficiency (separate production);
- $\eta_{th,B}$ reference thermal efficiency (separate production).

In particular, the value of the electric reference efficiency is a function of the year of construction of a cogeneration unit, the climatic condition, the electricity used on-site and the avoided grid losses due to decentralized production, while the thermal efficiency is a function of the fuel used to feed the CHP system.

The European Directive define as ‘micro-cogeneration unit’ a cogeneration unit with a maximum capacity below 50 kW_{el} .

If MCHP electric power is less than 50 kW, the PES has to be higher than zero in order to recognize this system as a cogeneration system.

Policy instruments

The Policy instruments proposed in Italy are based on:

- Energy Efficiency obligation: Tradable White Certificate (TWC);
- Renewable Energy obligation: Green Certificate (GC);
- financial instruments: feed-in tariffs, fuel tax reduction;
- net-metering.

A MCHP unit fuelled by natural gas, satisfying the high efficiency criteria ($PES > 0$), can have different advantages: dispatching priority, TWC, tax reduction on fuel purchased and net metering.

Tradable White and Green Certificates

TWCs, introduced by some European Union Member (Italy, UK, France), are tradable certificates, to improve the diffusion of efficient technologies that can guarantee primary energy saving.

TWCs depend on the primary energy saving, evaluated in terms of Tons of Oil Equivalent, TOE, that CHP can guarantee with respect to separate “production”.

A TWCs has actually a value of about 80 €/TOE.

If MCHP system is fuelled by renewable energy (wood pellets, vegetable oil, biogas) the system can obtain Green Certificate or a particular feed-in tariff, on the basis of the choice of the end user.

The value of green certificates is defined by the market, while the value of feed-in tariff is fixed and depends on the renewable source.

Other mechanisms

As regards the fuel tax reduction a quantity of natural gas equal to 0.25 Nm^3 per kWh of electric energy delivered can obtained a tax reduction.

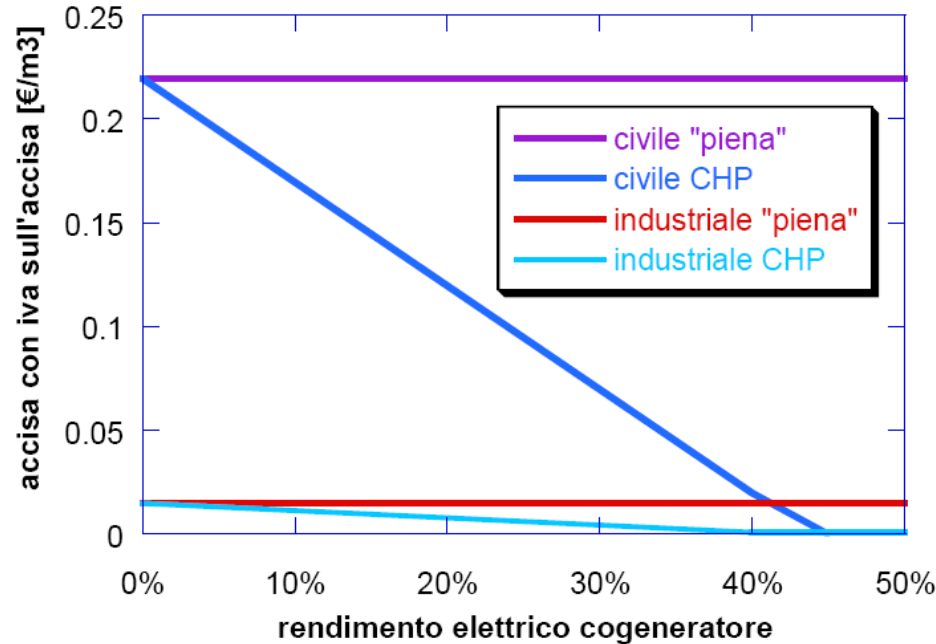

3.2 - Andamento dell'accisa sul gas naturale (comprensiva di IVA sull'accisa stessa) al rendimento elettrico del cogeneratore e del tipo di utilizzatore

Net-metering has been introduced in Italy to support RET, such as PhotoVoltaic (PV): this mechanism enables customers to use electric energy produced in excess of the their demand by PV system to cover their consumption in period of the day in which PV system does not work.

The same mechanism has been extended to MCHP systems that have a rated electric power lower than 200 kW.

Research: activity in Campania

Since '90, some research groups are analysing MCHPs and MCCHPs:

1993: Field analysis of residential **engine driven natural gas heat pump** in an office application", M. Sasso et al., Heat Pumps for Energy Efficiency and Environmental Progress, Ed. J. Bosma, Elsevier Science Publishers, Olanda

1996: **The future perspective of micro-CHP**, M. Sasso et al., Proc. of III° Int. Conf. Energy and Environment Towards the Year 2000, Capri

2003: test starting of the first **microcogenerator AISIN** available in Europe with an internal combustion engine derived by a Gas engine driven Heat Pump.

NAPOLI
MCHP and MCHP/EHP
plants
test-facility for residential application

FRIGNANO (CE)
MCHP/EHP-MCHP/ABHP
plants
in-situ office building

BENEVENTO
MCHP/HVAC-DW
plant
Test- facility

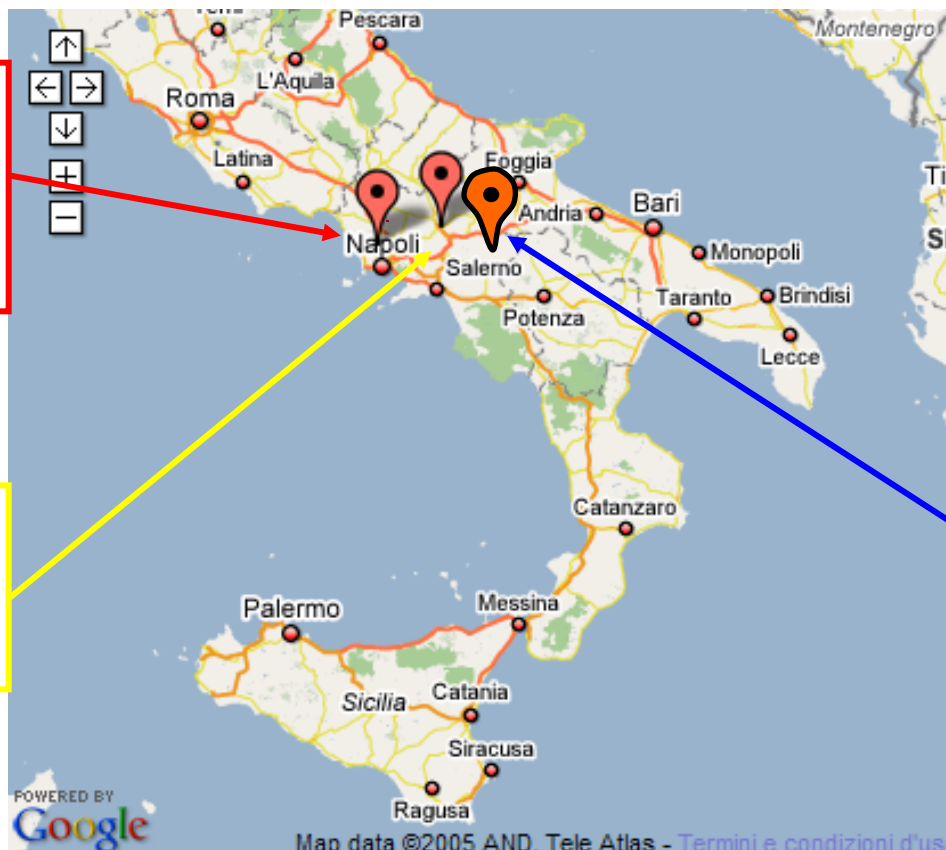

Research: MCHP/EHP Test plant_Napoli



data acquisition and elaboration
central unit

- Heaters with electric resistances;
- Washing machines and wash-dishes with suitable input for preheated water
- 80 l water heater and 200 l accumulation boiler, both with electric resistances and internal coil heat exchanger
- 3 fan coils
- Heat exchanger for hydronic hot water plant
- Sensors for the measurement of electrical, thermal and flow quantities

Research: MCHP/EHP Test plant_Napoli, results

With the support of:

TECNOCASA
CLIMATIZZAZIONE

Sole European Distributor **AISIN**
Gas Heat Pump (GHP) / Microgenerator (MCHP)

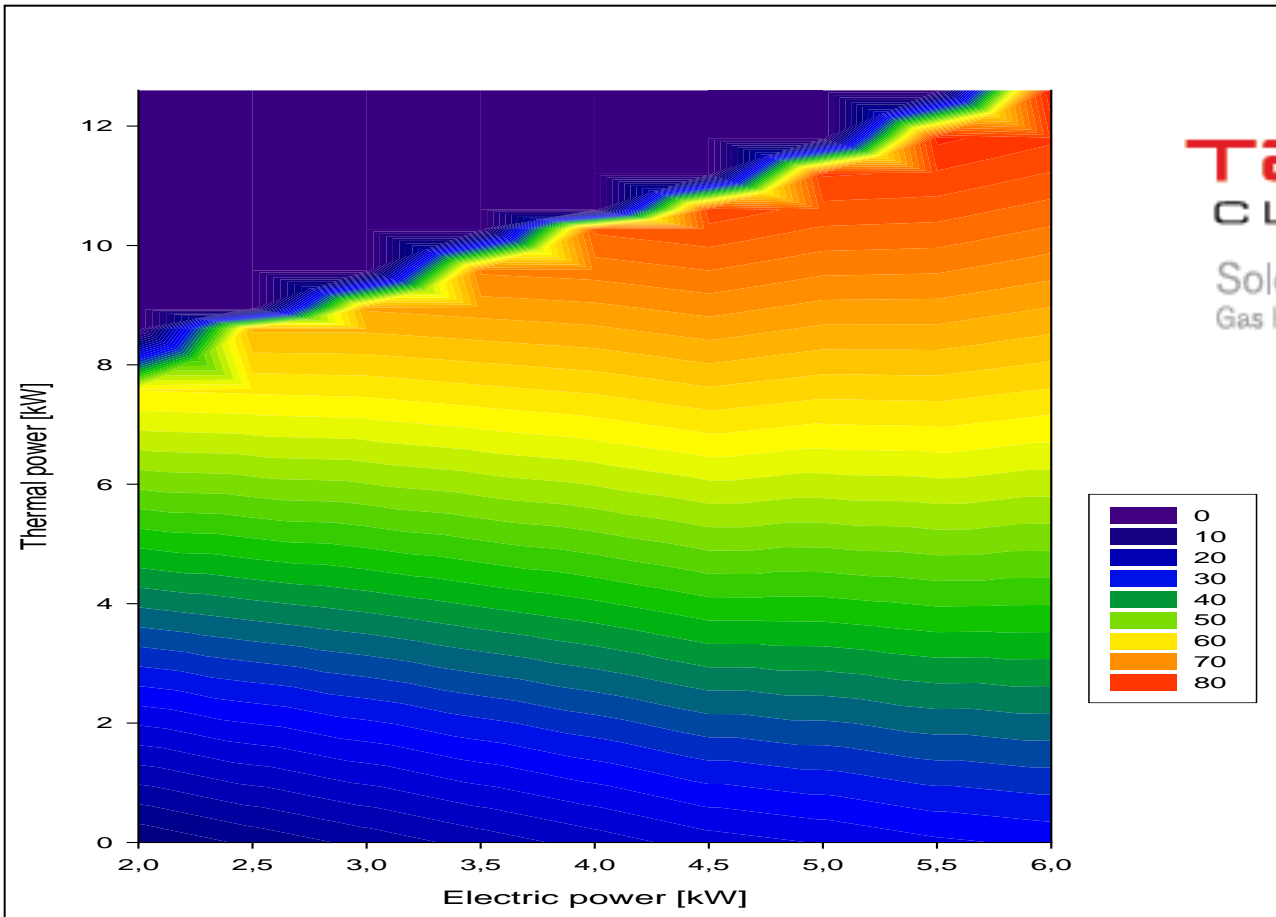

PER as a function of electric and thermal power.

Source: Sasso et al., 2006, "Experimental analysis of micro-cogeneration units based on reciprocating internal combustion engine", Energy and buildings, Vol. 38, pp. 1417-1422.



Prof. M. Sasso, 27 October 2010, NIST, Gaithersburg, MD, USA

Research: MCHP/EHP Test plant_Napoli

Nominal El. power_6 kW



3.6 kW

2.4 kW

5.8 kW

heating mode

Nominal Th. power_11.7 kW

11.7 kW

3.6 kW

6.7 kW

cooling mode

11.7 kW

Research: MCHP/EHP Test plant_Napoli, results

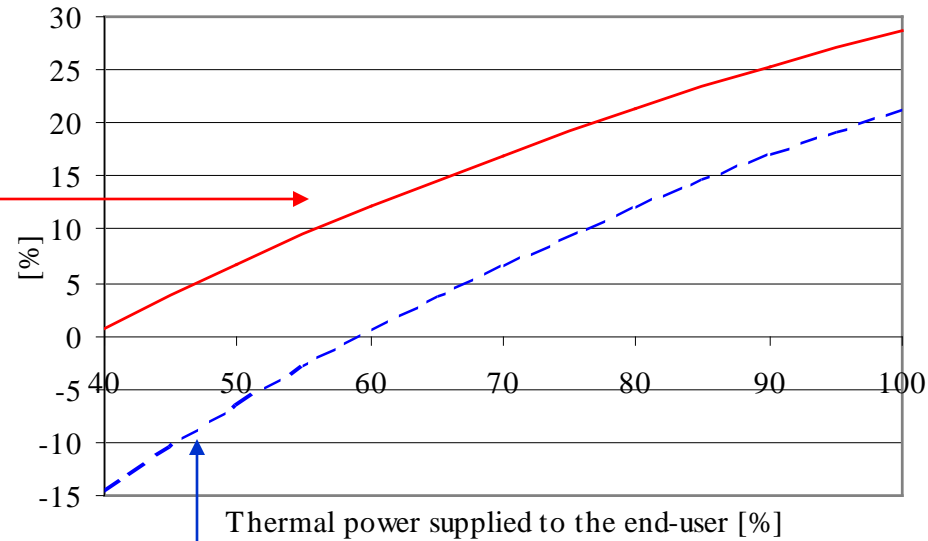
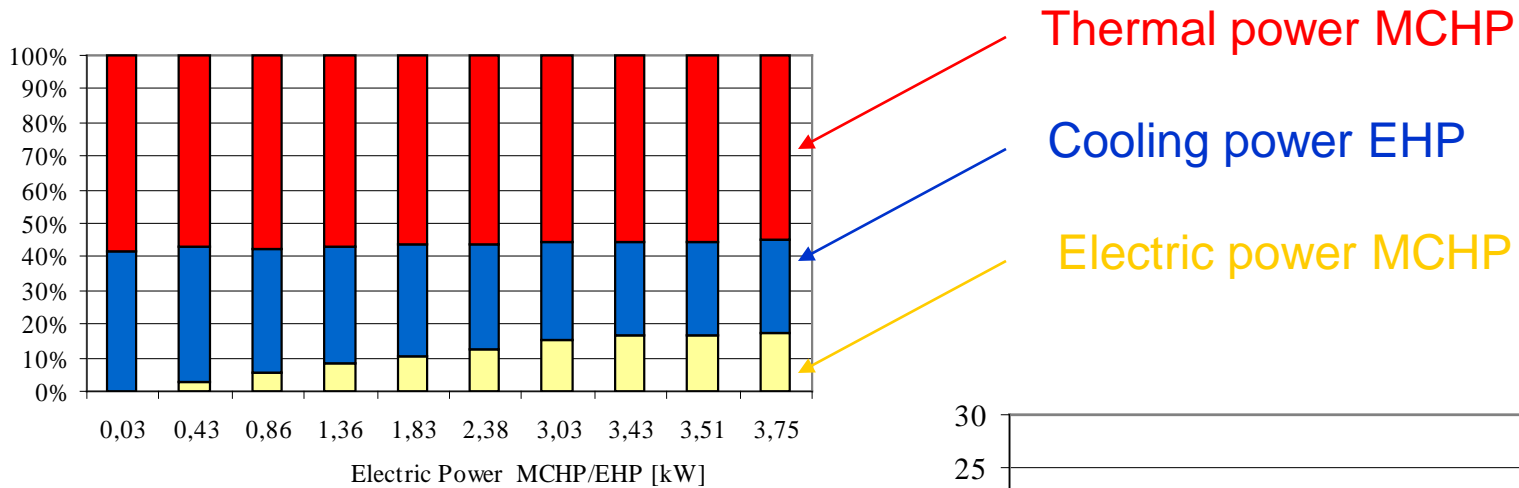

Avoided CO₂ emissions

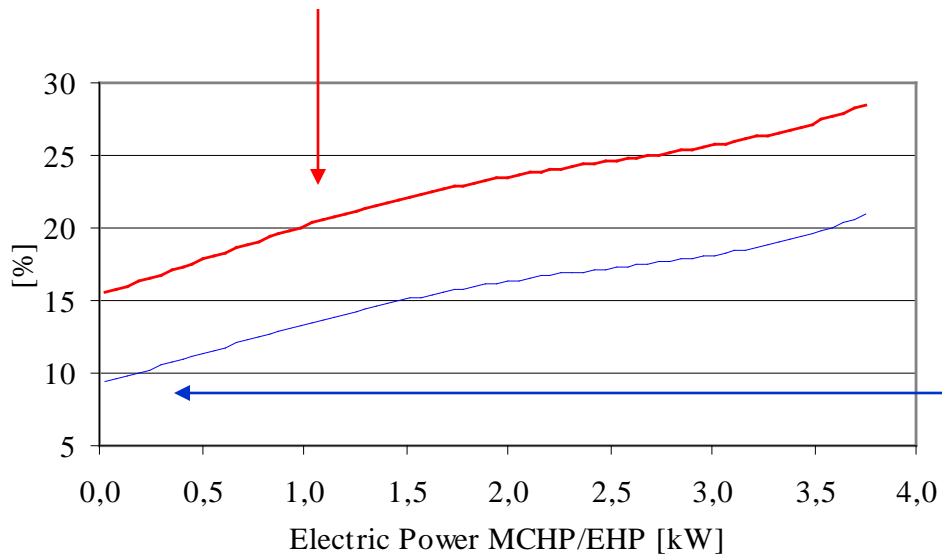

Primary Energy Saving

Department DCP&Built Environment Control Laboratory_RiAS

Small polygeneration system based on gas fuelled internal combustion engine coupled with an Air Cooled Water Chiller, ACWC



MCHP

ACWC

The system supplies thermal (heating and hot water, 12 kW), electrical (6 kW) and cooling energy (7.5 kW) to a part of a building with offices and laboratories.

During summer season the MCHP can activate also an absorption heat pump (10 kW) .

Research: Frignano, cooling season

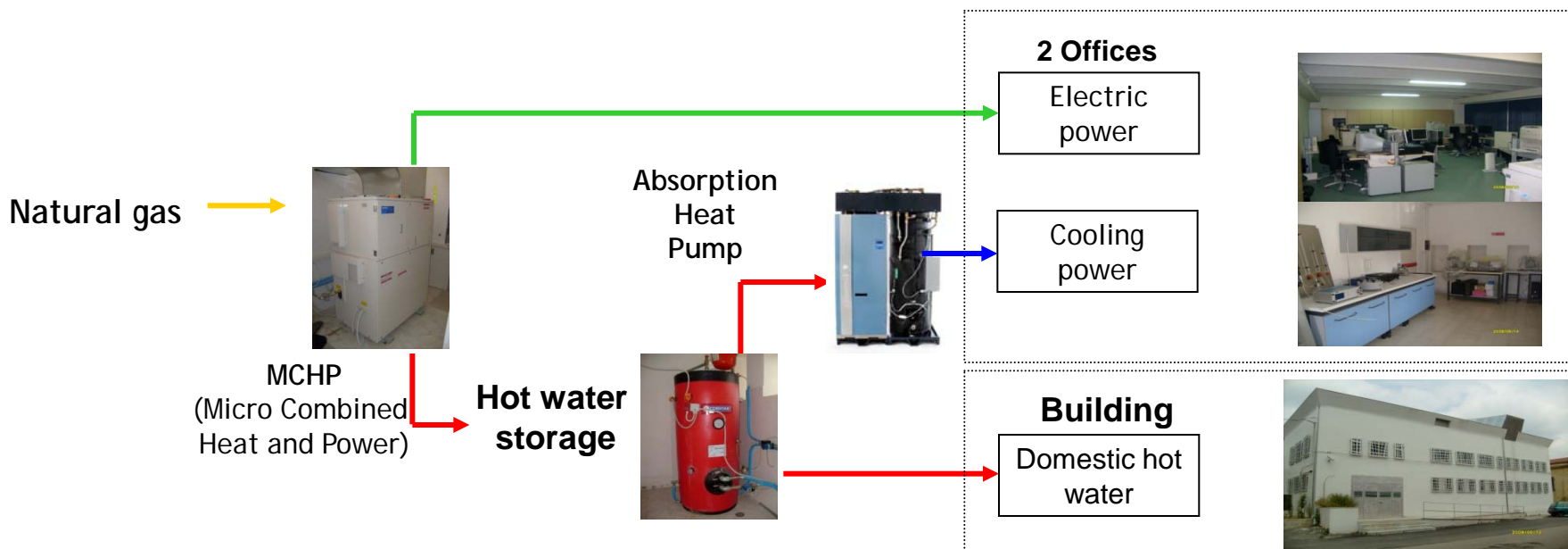
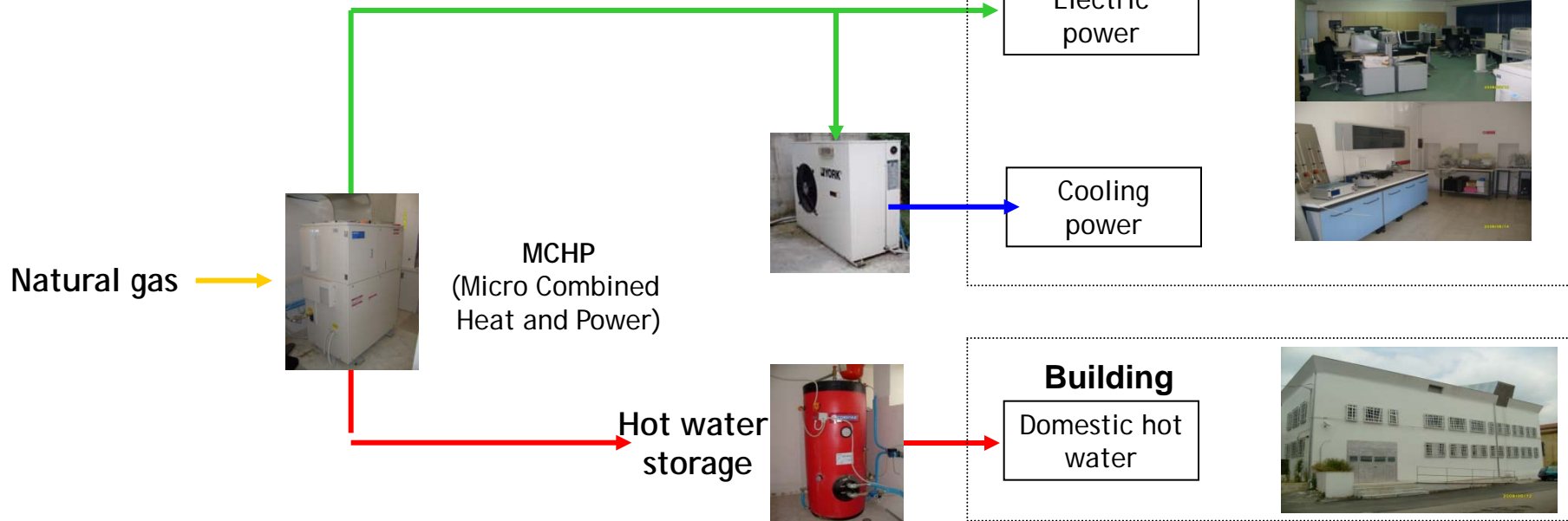

advanced desiccant air handling unit coupled to a reciprocating internal combustion.
The air handling unit allows, during summer operation to process 800 m³/h of wet air.

The MCHP supplies thermal energy (12 kW) to the regeneration of the sorption material (silica gel) of the desiccant wheel.

Cogeneration power (6 kW) is used to supply electricity for air handling self consumptions (fans, pumps, ...), to drive the electric chiller and finally for the external devices. The MCHP/HVAC-DW system is able to import or to export electricity to the external grid.



Research: Benevento, Experimental test plant

LEGENDA ACCESSORI

	VALVOLA A SARACINESCA
	VALVOLA DI BILANCIAMENTO
	FILTRO
	VALVOLA A TRE VIE
	POMPA

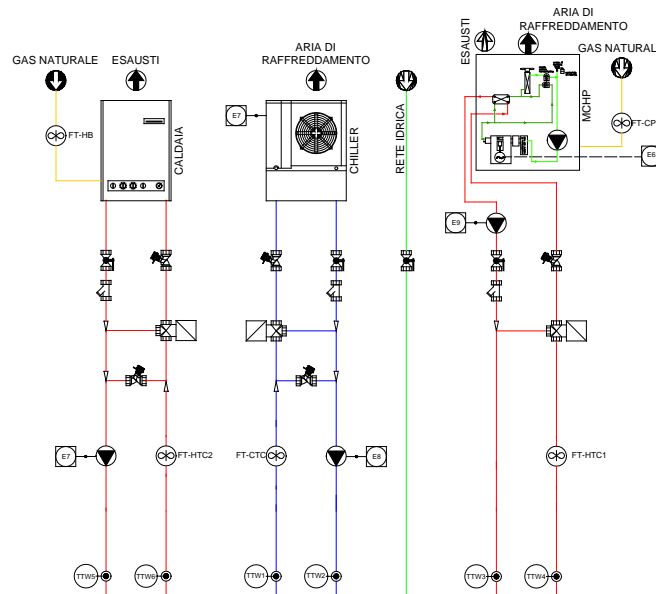

LEGENDA SENSORI

Ta1, ... 8		temperatura aria	SIEMENS
Tw1, ... 6		temperatura acqua	SIEMENS
UR1		umidità relativa aria esterna HUMITRAC	GESENSING
UR2, ... 5		umidità relativa da condotto HUMITRAC	GESENSING
Va1.2		velocità dell'aria	SIEMENS
Vw1, ... 3		portata volumetrica acqua SF10	DWYER
Pa1, ... 3		pressione differenziale 694	INDUSTRIE TECH.
Mg1.2		portata massica gas	BAGGI
E1, ... 9		contatore energia elettrica	GOSSEN M.

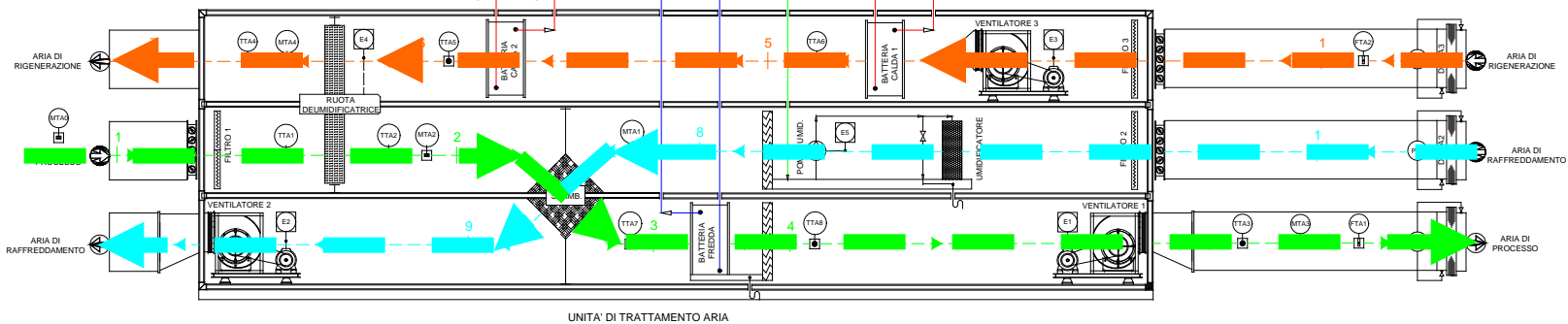

- Process Air
- Cooling Air
- Regeneration Air

Research: Benevento, Experimental test plant, results

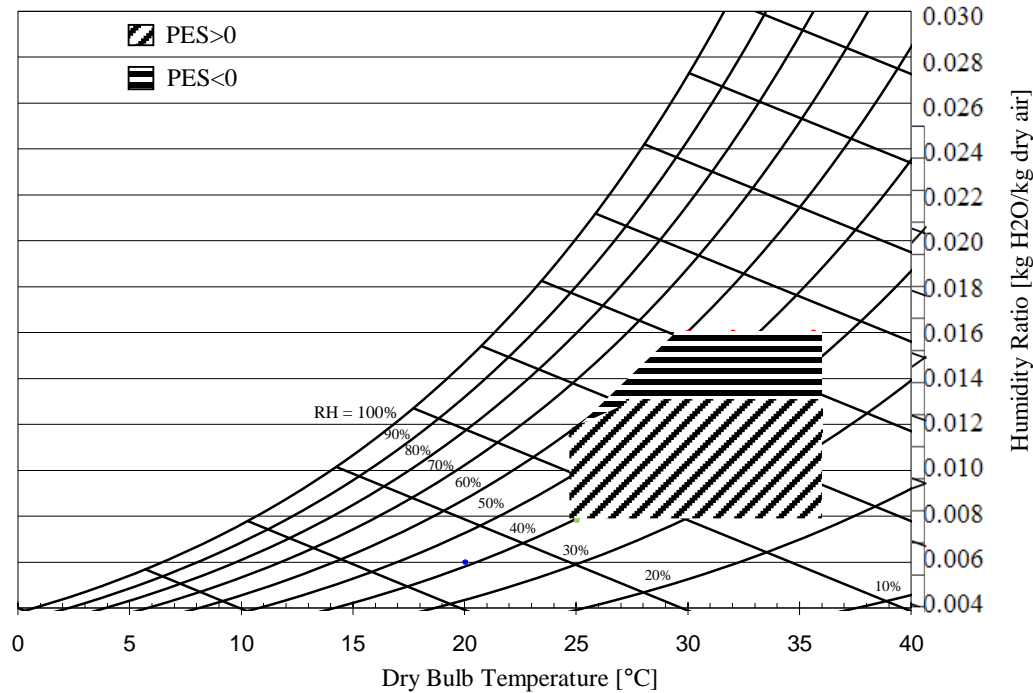

The following analysis have been carried out:

- Identification of outdoor air conditions that give a positive PES;
- Sensitivity analysis: PES as a function of electric grid efficiency.

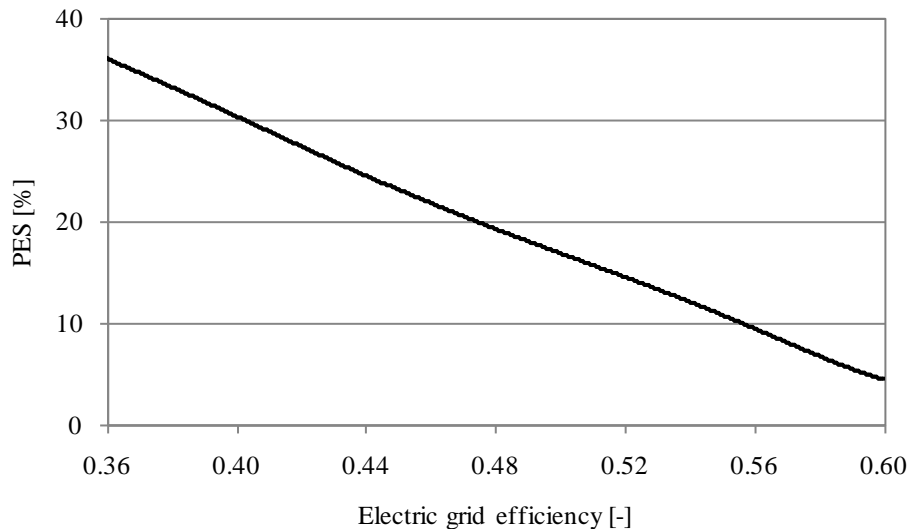

Source: G. Angrisani, F. Minichiello, C. Roselli, M. Sasso, *Experimental investigation to optimise a desiccant HVAC system coupled to a small size cogenerator*, *Applied Thermal Engineering* 2010, in press.

Development I/II

- o **Gas Utility:** gas utilities plan to supply not only natural gas but also energy conversion systems: Gas cooling technology (ABHP, GHP, microgenerators) according to an Energy Service Company approach



BAXI Ecogen: Stirling Engine 1 kWe

- o **Manufacturers:** many R&D projects are in progress



Development II/II

- o **Standard:** testing procedure is in a draft phase to provide test methods for determining the performance of MCHP.
- o This effort is mainly due to:
 - o the quick diffusion of microcogenerators;
 - o the introduction of energy labeling procedure;
 - o the need to define ex-ante their efficiency to quantify the financial tools to support MCHP diffusion.

Impianti di piccola cogenerazione alimentati a combustibili liquidi e gassosi. Misurazione ex-ante delle prestazioni energetiche (Micro cogeneration plants. Ex-ante analysis of energy performance)



Conclusions

- Distributed MCHP&MCCHP systems allow benefits with respect to the reference separate energy “production”:
 - primary energy saving;
 - low pollutant emissions;
 - reduction of operating costs.
- At the moment small devices based on ICE are available on the market
- Aiming a large diffusion of high efficiency technologies, such as MCHP&MCCHP, in Italy there are the following policy instruments:
 - financial instruments, such as economic grants, taxes reduction, feed-in tariffs;
 - Net-metering;
 - Energy Efficiency and Renewable Energy obligations, such as Tradable White Certificates and Green Certificates.
- R&D activities are in progress with respect to:
 - experimental and test analysis;
 - gas utility;
 - manufacturers;
 - standard rating.

Thanks for your attention!



Prof. Maurizio Sasso
Facoltà di Ingegneria
Università degli Studi del Sannio

Tel. +390824305509

Fax +390824325246

E-mail: sasso@unisannio.it