

Experiences with Micro-Cogeneration in Residential Buildings in Germany

Workshop

"Building Integration of Micro-Generation Technologies"

NIST, October 27th 2010, Gaithersburg USA

Peter Tzscheuschler

Institute for Energy Economy and Application Technology

Technische Universität München

- Studied Systems
- Lab tests at TUM
 - System Integration
 - Results
 - Energy, CO₂ savings
- Field tests in southern Bavaria
 - System Integration
 - Results

Hydraulic Scheme

- Example Senertec Dachs

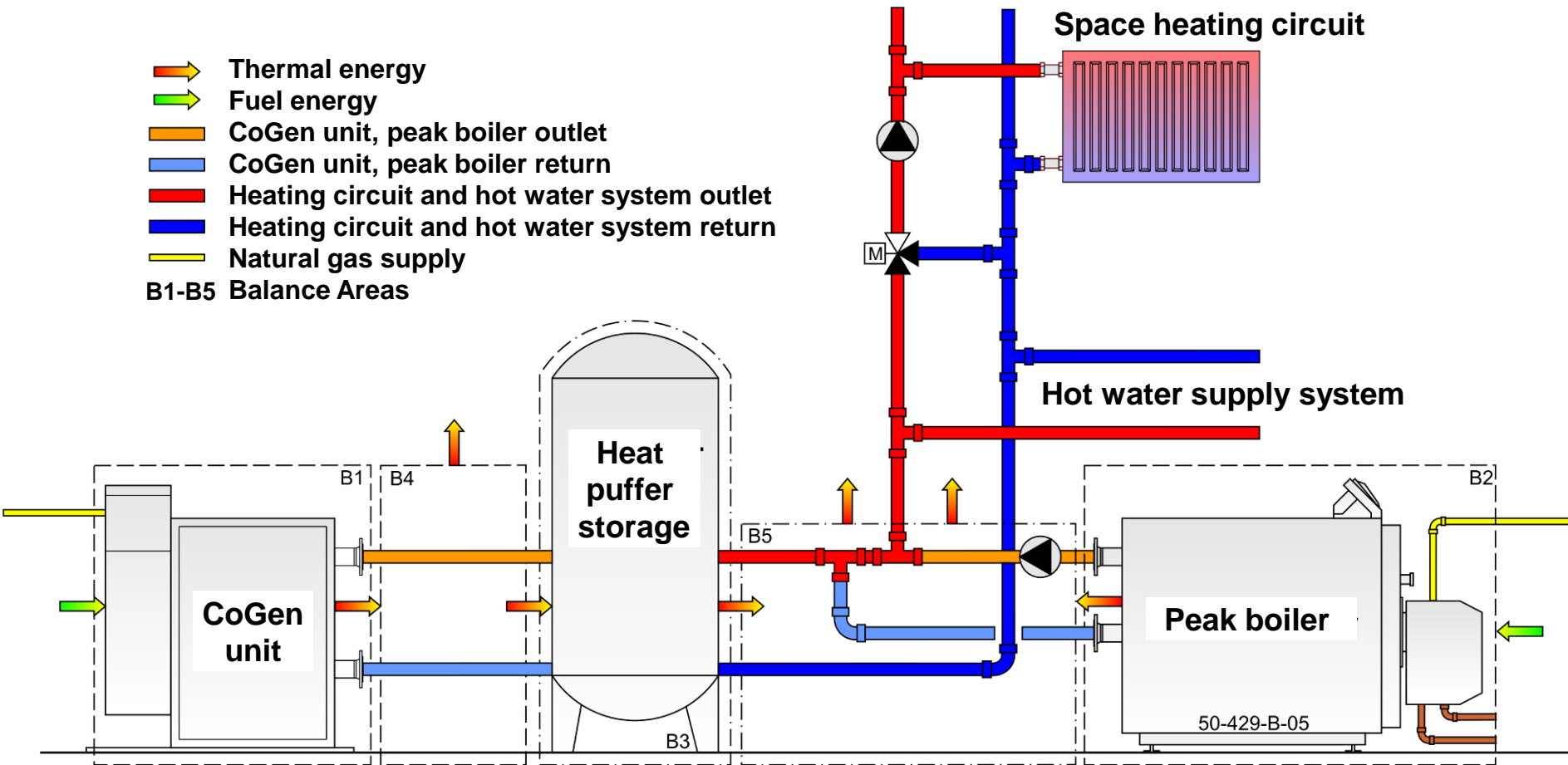



Ⓛ

Senertec
Dachs

5,5 kWh_{el},
14,0 kWh_{th}



Ⓛ

Solo Stirling
Mod. 161

7,5 kWh_{el},
22,0 kWh_{th}



Ⓛ ⓕ

Vaillant
ecoPower

4,7 kWh_{el},
12,5 kWh_{th}



ⓕ

Remeha
eVita

1,0 kWh_{el},
5,0 kWh_{th}
+ aux. burner



~~ⓕ~~

OTAG
Lion PB

2,2 kWh_{el},
18,0 kWh_{th}

- Close to reality experiments
- Reproducible conditions
- Acquisition of all relevant parameters
- Application of type-days
 - summer
 - transition
 - winter

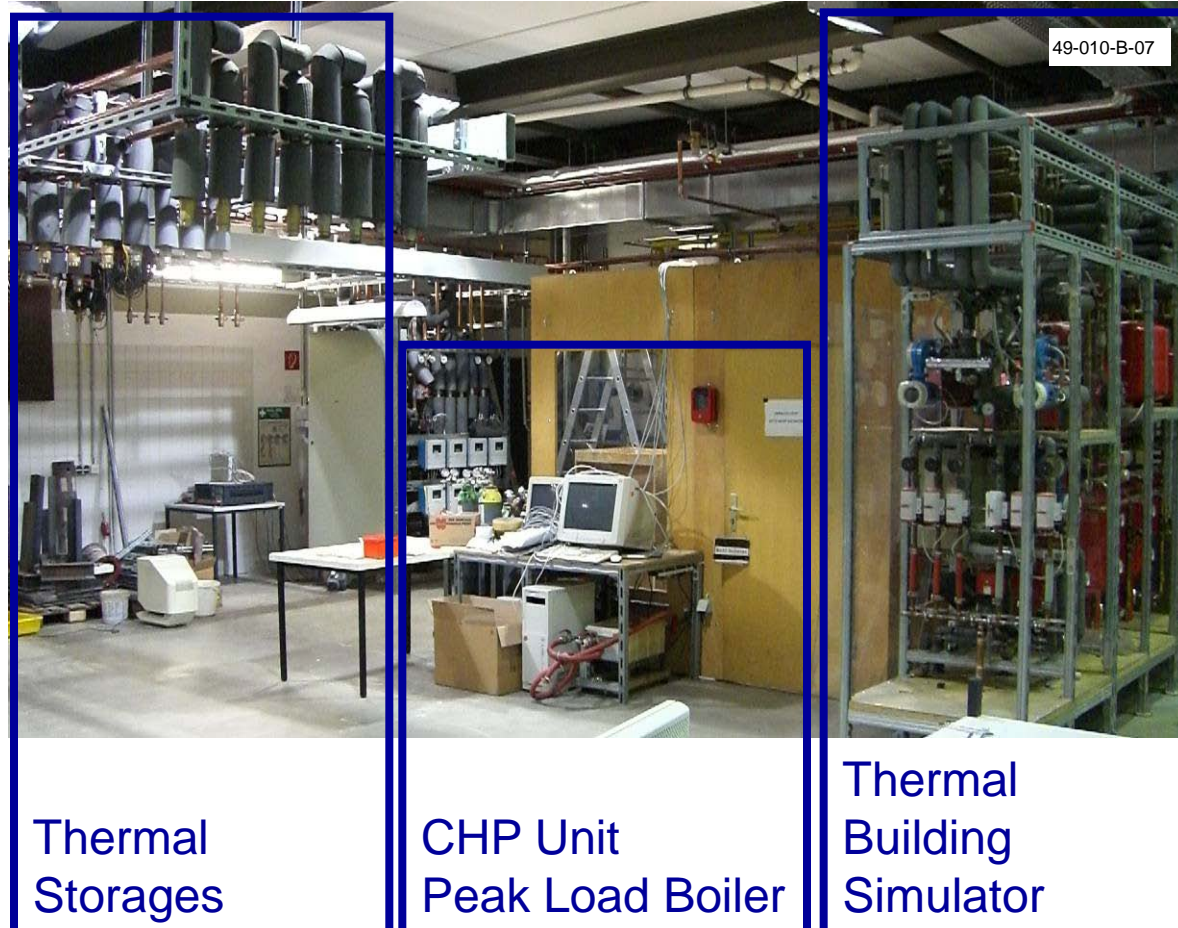

Results of Type Day Measurements

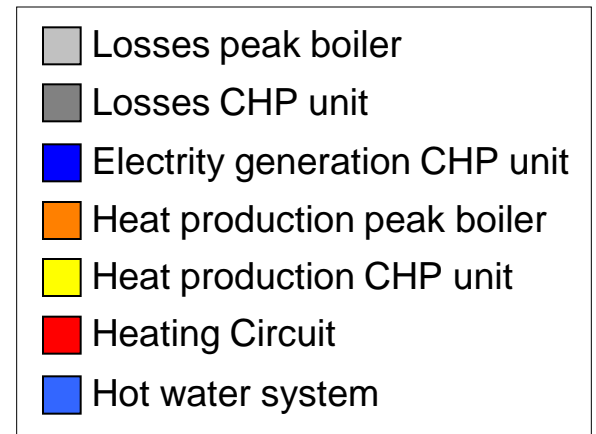
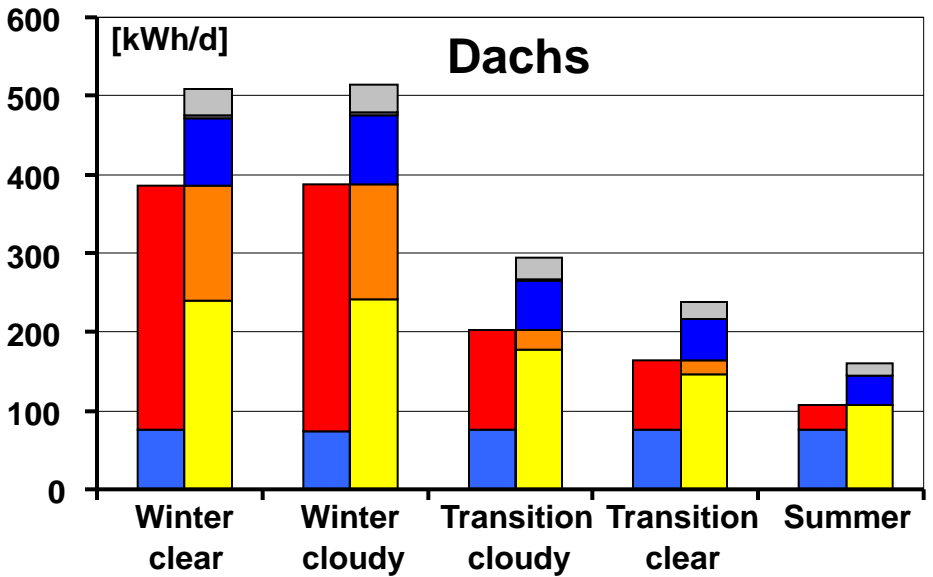
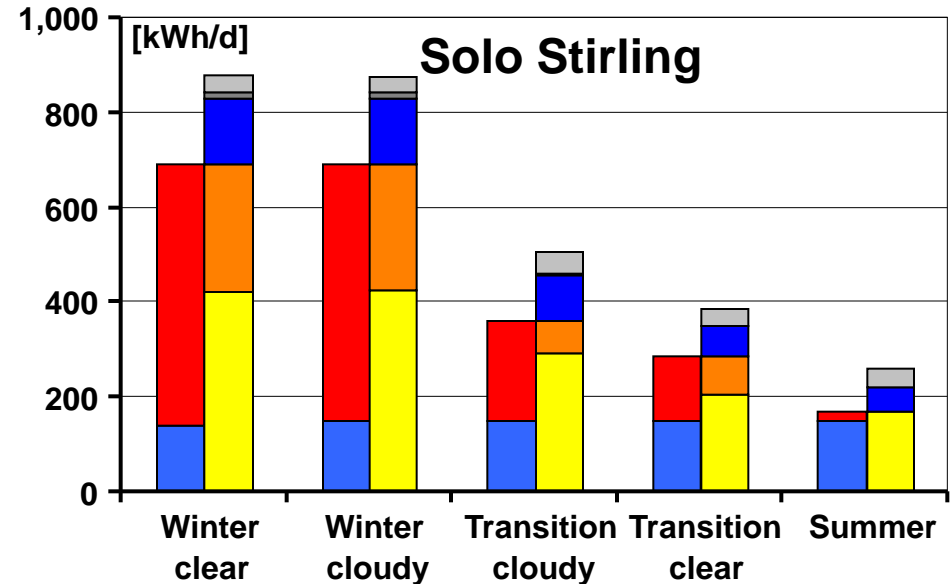
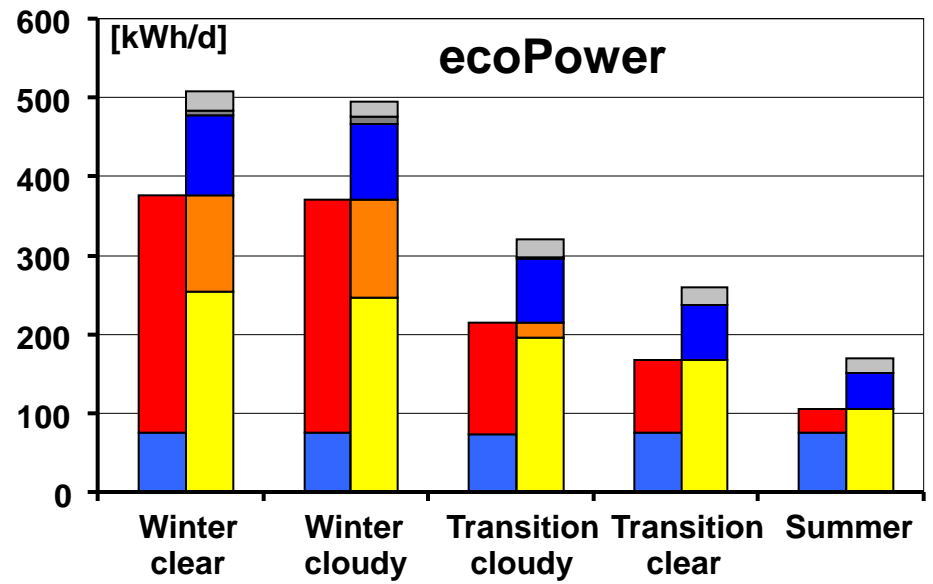

Corrected from influence of test stand

Duration Curve of Demand and Generation

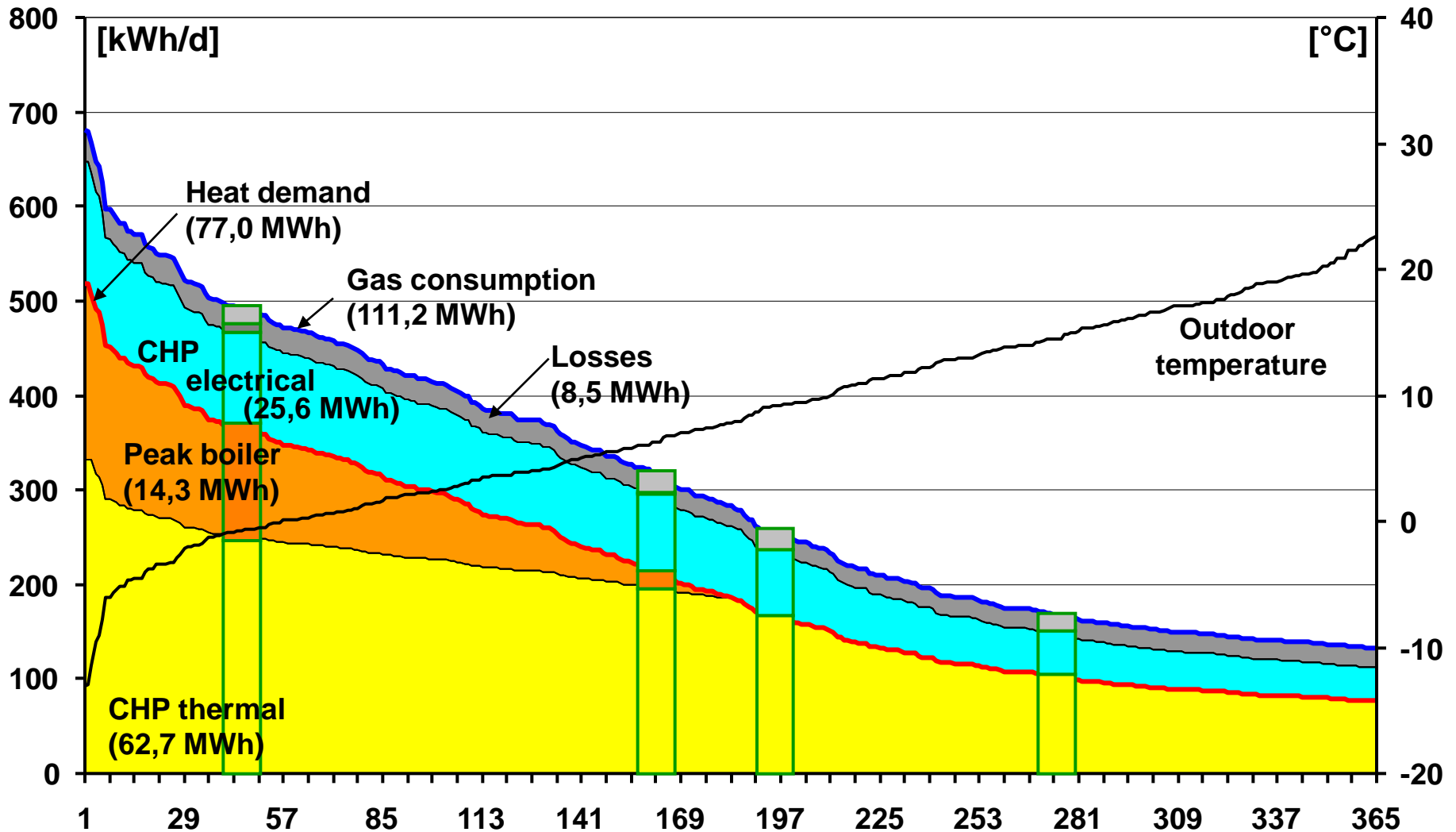

Primary Energy Consumption

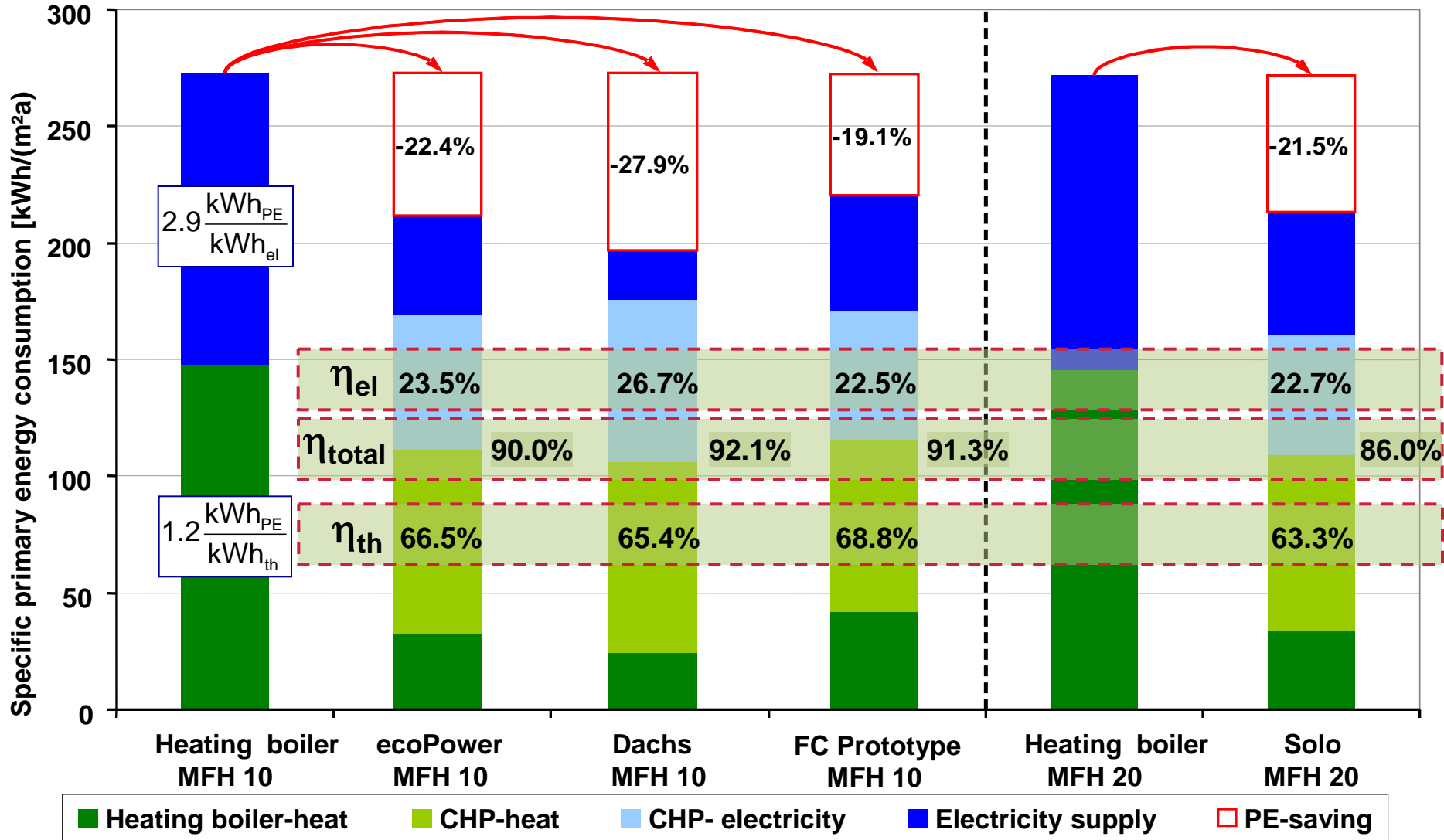

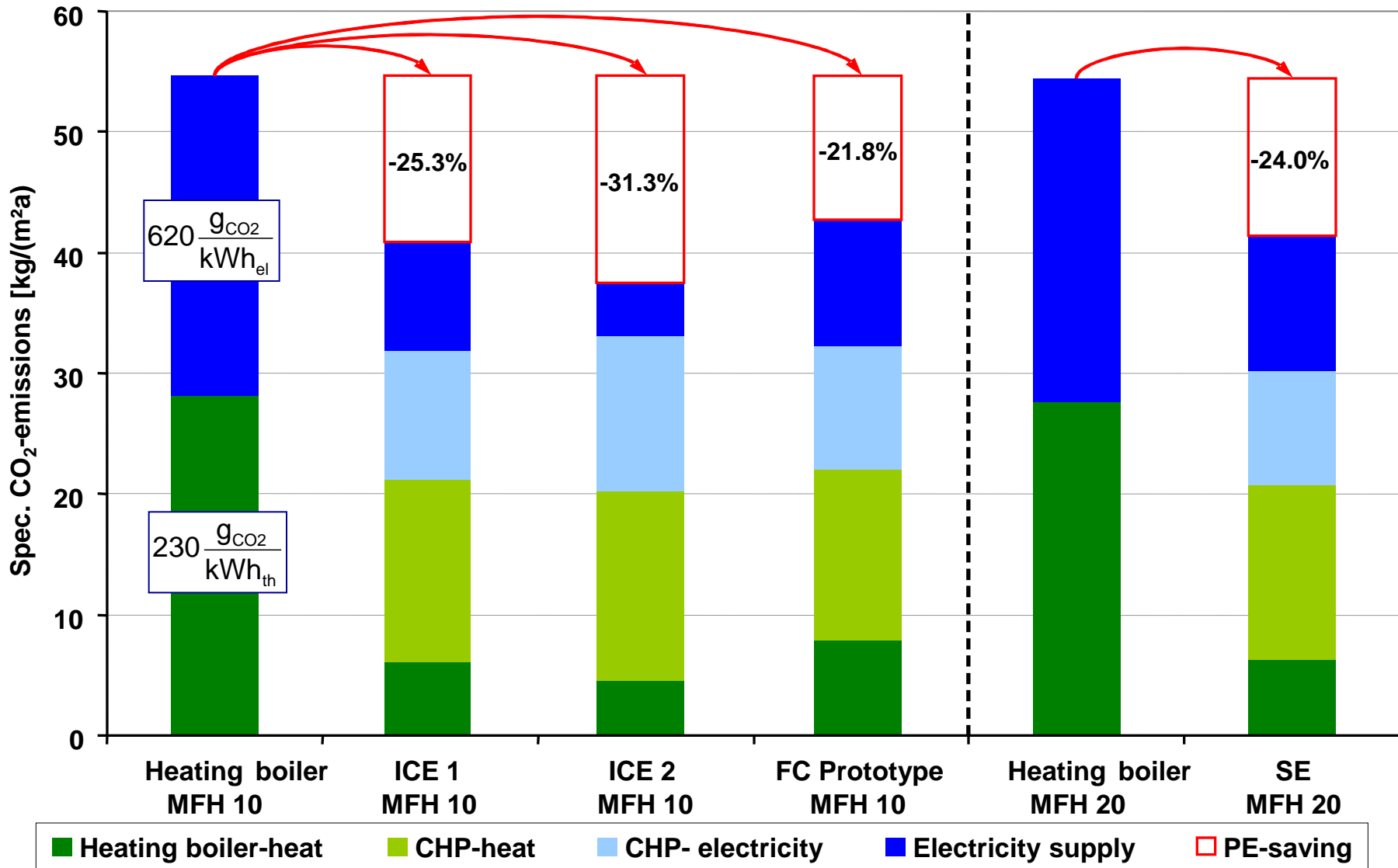

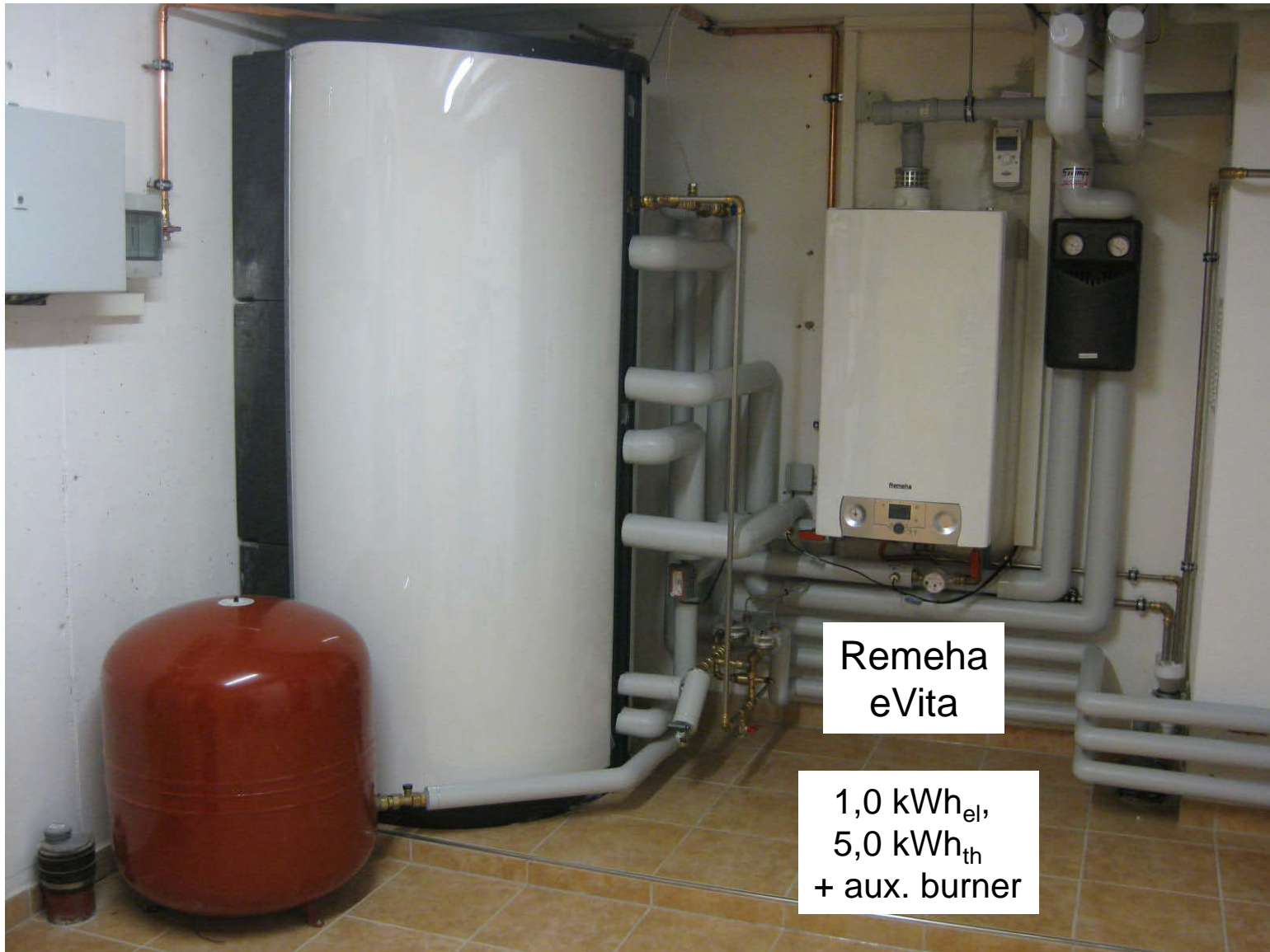

- Cooperation with local gas utility
- Field trial was announced in newspapers
 - > 1,200 applications
 - > 800 met the parameters
- 4 were chosen
 - Systems were given for free
 - except a contribution of 1,500 € for the installation
- TUM integrated measuring equipment
 - all relevant parameters
 - remote access via internet

A: Combined Storage

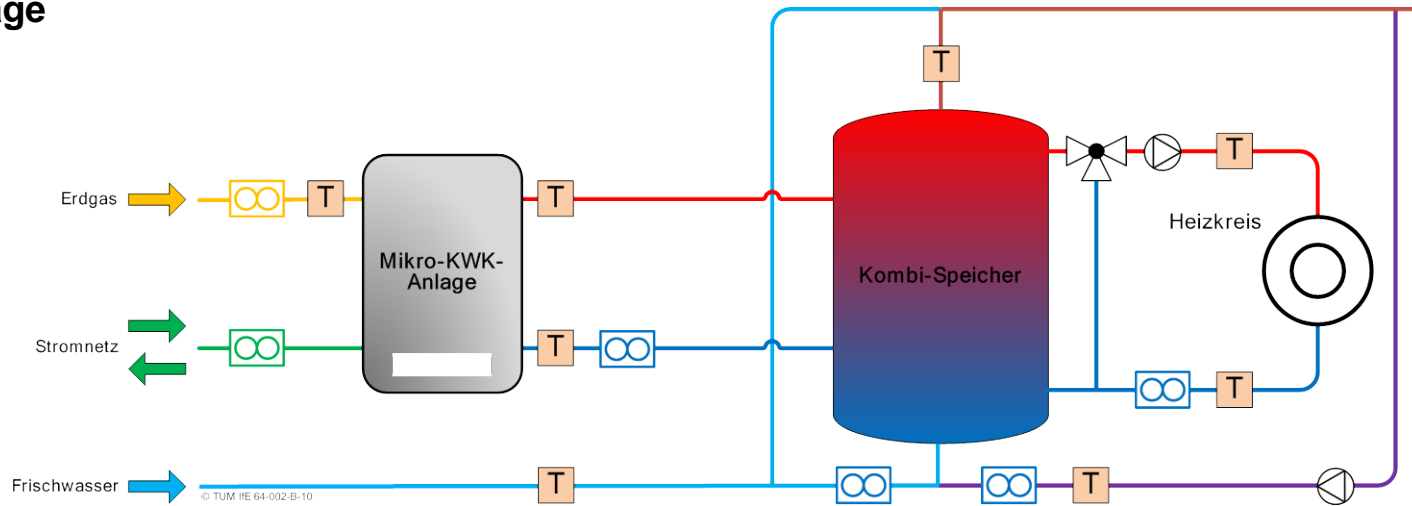

B: DHW Storage

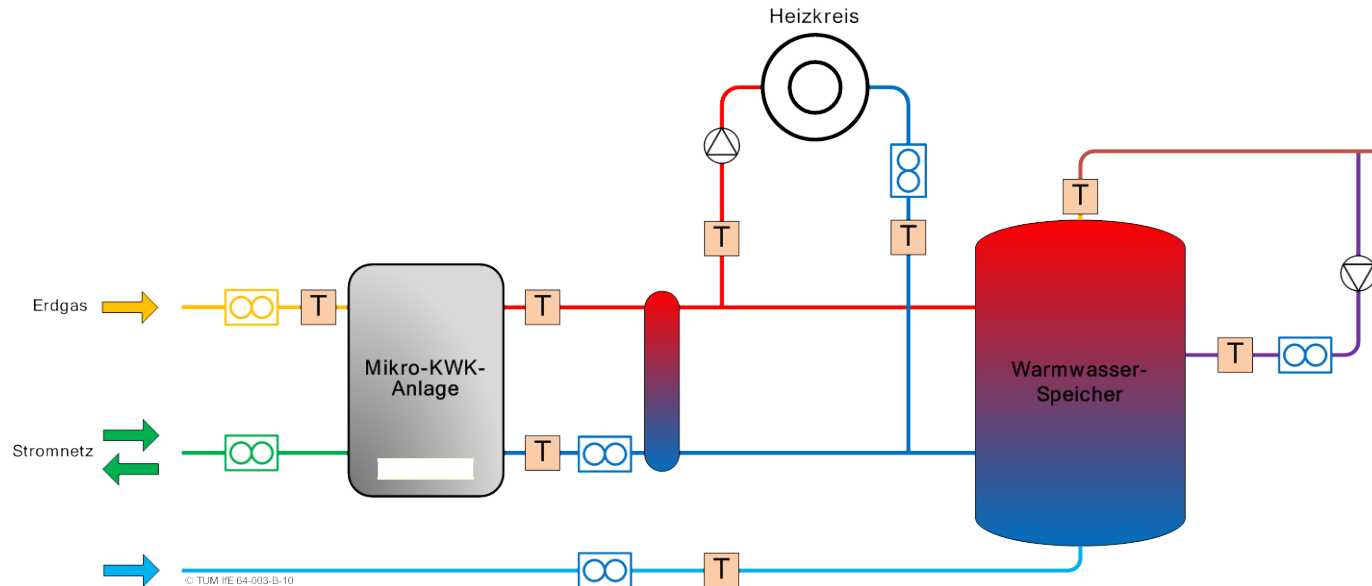

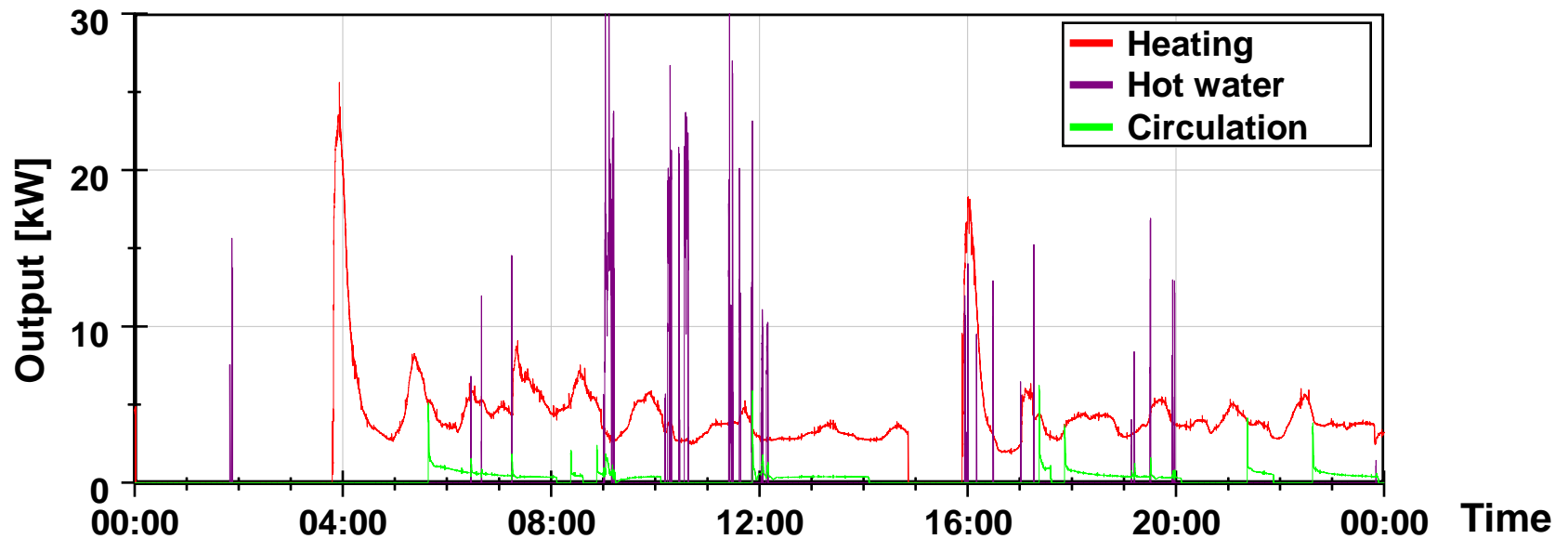
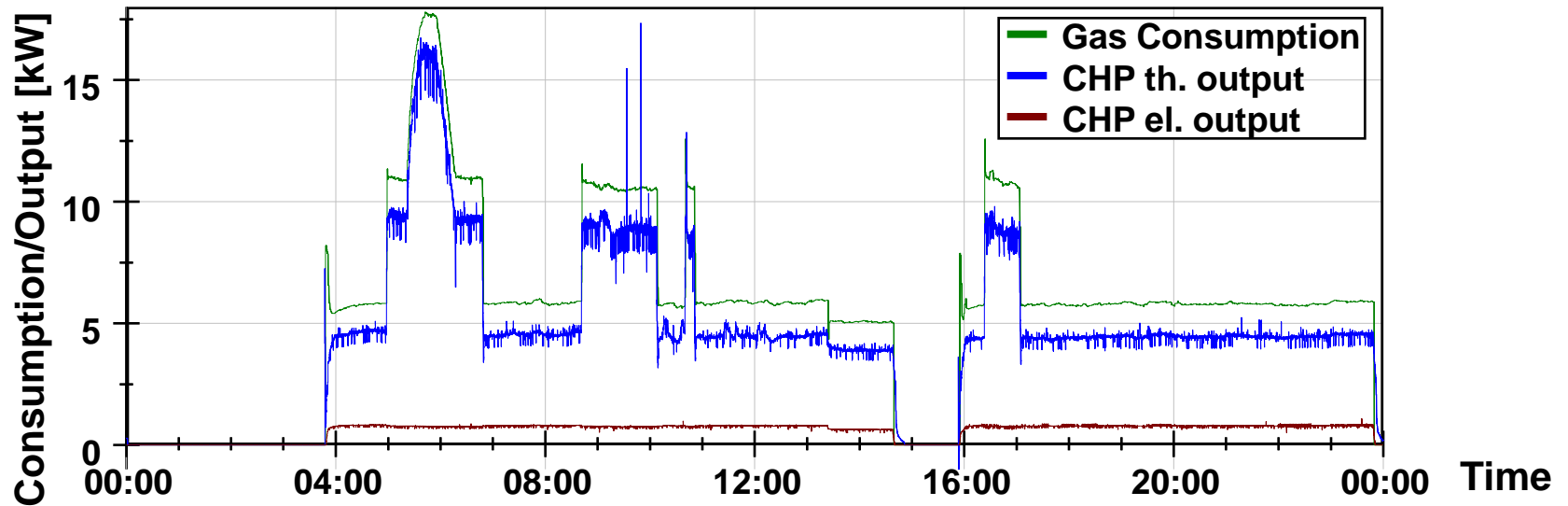

μCHP Usage on a Winter

μCHP unit

- 81% thermal efficiency
- 10% electrical efficiency
- 91% total efficiency

Total System

- 71% thermal efficiency
- 10% electrical efficiency
- 81% total efficiency

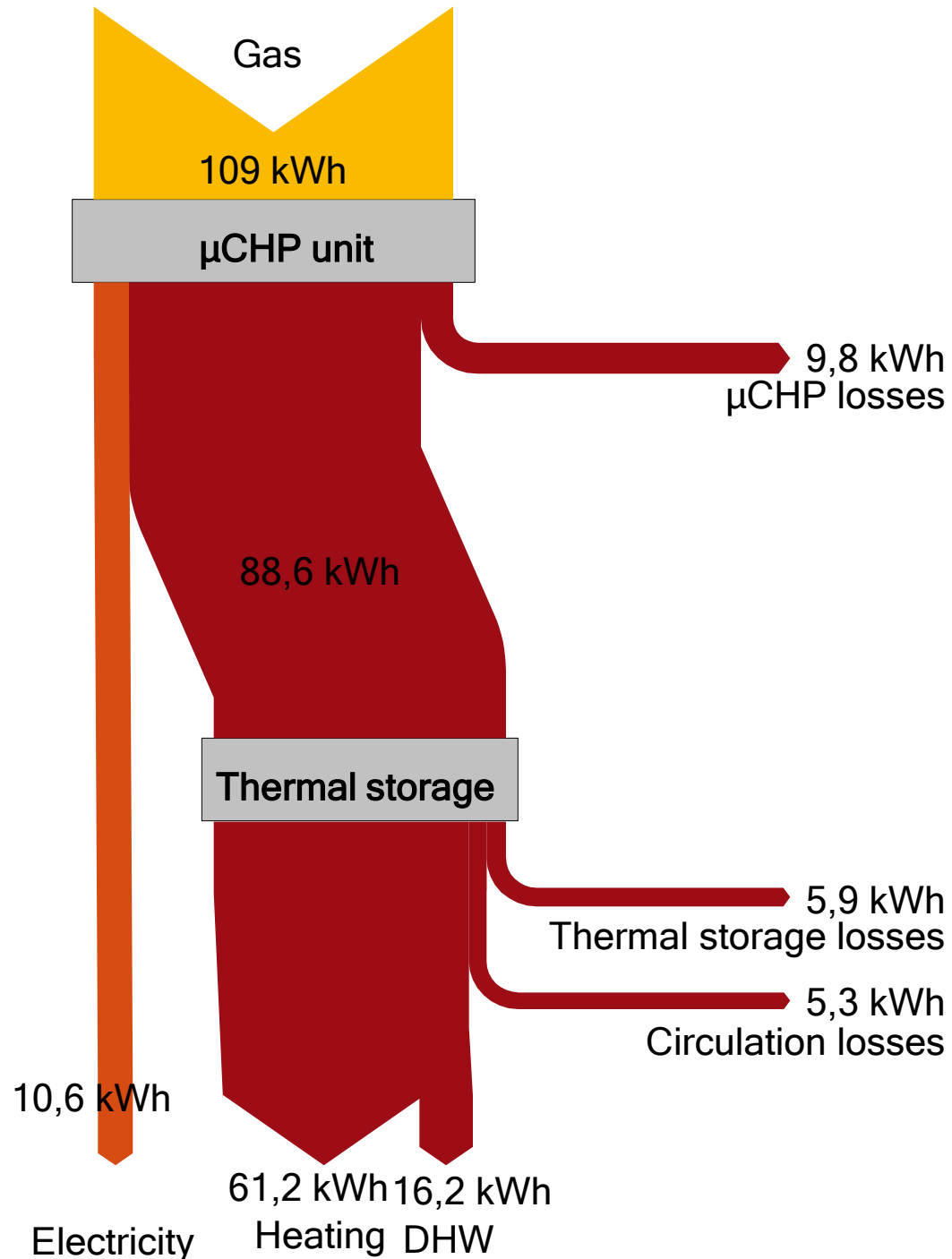

		System 1*	System 2	System 3	System 4
Time period	[h]	2,124	4,342	4,388	4,363
Gas Consumption	[kWh]	3,920	21,938	17,335	17,582
El. Generation	[kWh]	282	2,288	1,726	1,944
Heat output	[kWh]	3,215	18,576	14,041	14,001
Electrical efficiency**	-	7%	10%	10%	11%
Thermal efficiency	-	82%	85%	81%	80%
Total efficiency	-	89%	95%	91%	91%
On-Site use	-	71%	61%	34%	83%

* short runtime due to technical problems

** related to total gas consumption, incl. aux. burner

- Systems working very reliable
- Operation can be optimized

- People are very interested in producing their own electricity
- μ CHP systems are highly efficient
- Systems are (so far) very reliable
- Potential for optimization of control strategies

Thank you for your Attention

